

WORK	SEC.	甲	乙	丙	PRINTING DEGREE		MATERIAL AND PRINTING DESCRIPTION	LG MODEL NAME	SUFFIX	LANGUAGE	PAGE	REMARK
	BRAND	MODEL	P/NO.	EXTERIER	INTERIER							
40		FH4U2TDH1N	MFL68585840 ver.082615.00	1	1	材质: 70g 双层纸	F14U2TDHP1N.ABWPBAL	ABWPBAL	English	48	C3 Hybrid English Panel	

<<备注 >>

1. 材质，印刷，尺寸参照作业表.
2. 印刷，文字大小和线条以LG设计基准.
3. 数字大小依据一般规格.
4. 批量生产前取的设计限度.
5. 本部品不应含有禁止物质(Pb, Cd, Hg, Cr+6, PBB, PBDE)，详细内容满足LGEPN-Z-1023.

<< NOTES >>

1. Material,printing and exterier size are refer to work tables.
2. Printing, tsxt size and line are based on LG desing film.
3. Exterier size on the drawing is cutting line.
4. Before product controlled by criteria sample.
5. The part should not contain prohibited substances(Pb,Cd,Hg,Cr+6,PBB,PBDE) and detailsShould comply with LGEPN-Z-1023.

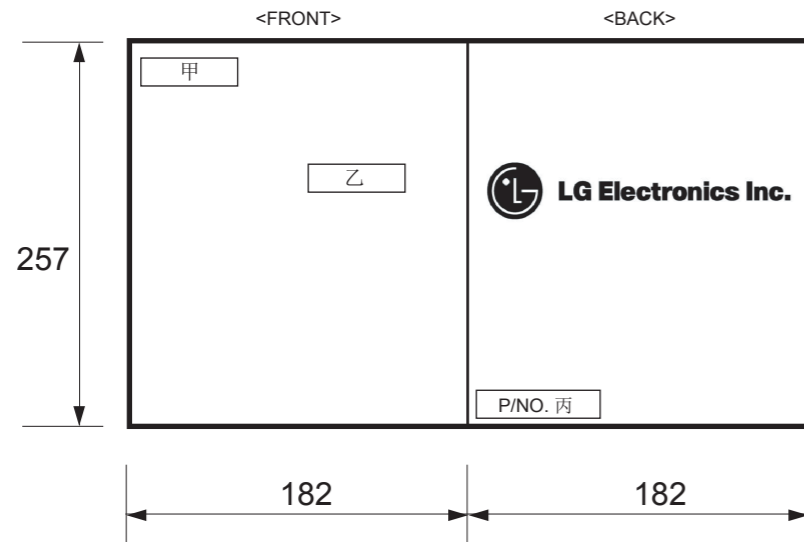

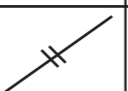
		Unit	mm	SCALE	1/1	TITLE	MANUAL, OWNER'S DRUM-EXPORT 1/1
MODELING	DESIGNED	REVIEWED	CHECKED	APPROVALED			
	彭显进	程宏雷	薛秀超	李揆喆		DWG. No.	MFL68585840
LGEPN LG Electronics Inc.			RELATED DRAWING				

OWNER'S MANUAL

WASHING MACHINE



Before beginning installation, read these instructions carefully. This will simplify installation and ensure that the product is installed correctly and safely. Leave these instructions near the product after installation for future reference.

FH4U2TDH(0-9)N



MFL68585840
ver.082615.00



www.lg.com

TABLE OF CONTENTS

This manual is produced for a group of products and may contain images or content different from the model you purchased.

This manual is subject to revision by the manufacturer.

SAFETY INSTRUCTIONS	03
Important Safety Instructions.....	05
INSTALLATION.....	08
Specifications	08
Accessories	08
Installation Place Requirements	09
Unpacking and Removing Shipping Bolts	10
Using Non-Skid Pads (Optional).....	11
Wooden Floors (Suspended Floors).....	11
Leveling the Washing Machine.....	12
Connecting Inlet Hose	12
Installation of Drain Hose	15
Electrical Connections (In the UK Only)	15
OPERATION	16
Using the Washing Machine.....	16
Sorting laundry	17
Adding Cleaning Products	18
Control Panel.....	20
Programme Table	21
Option Cycle	26
Dry (Optional).....	28
Using Smart Function (Optional)	30
MAINTENANCE	31
Cleaning your Washing Machine.....	31
Cleaning the Water Inlet Filter	31
Cleaning the Drain Pump Filter	32
Cleaning the Dispenser Drawer.....	33
Tub Clean (Optional)	33
Caution on Freezing During Winter	34
Using the Smart Diagnosis™ Function	36
TROUBLESHOOTING	37
Diagnosing Problems	37
Error Messages	39
WARRANTY.....	41
OPERATING DATA.....	44

SAFETY INSTRUCTIONS

The following safety guidelines are intended to prevent unforeseen risks or damage from unsafe or incorrect operation of the product.

The guidelines are separated into 'WARNING' and 'CAUTION' as described below.

 This symbol is displayed to indicate matters and operations that can cause risk. Read the part with this symbol carefully and follow the instructions in order to avoid risk.

 **WARNING** - This indicates that the failure to follow the instructions can cause serious injury or death.

 **CAUTION** - This indicates that the failure to follow the instructions can cause the minor injury or damage the product.

WARNING

To reduce the risk of fire, electric shock, or injury to persons when using your product, basic safety precautions should be followed, including the following.

CHILDREN IN THE HOUSEHOLD

This appliance is not intended for use by persons (including children) with reduced physical, sensory or mental capabilities, or lack of experience and knowledge, unless they have been given supervision or instruction concerning use of the appliance by a person responsible for their safety. Children should be supervised to ensure that they do not play with the appliance.

For use in Europe:

This appliance can be used by children aged from 8 years and above and persons with reduced physical, sensory or mental capabilities or lack of experience and knowledge if they have been given supervision or instruction concerning use of the appliance in a safe way and understand the hazards involved. Children shall not play with the appliance. Cleaning and user maintenance shall not be made by children without supervision. Children of less than 3 years should be kept away unless continuously supervised.

GROUNDING REQUIREMENTS

WARNING

For your safety, the information in this manual must be followed to minimize the risk of fire, explosion, or electric shock, or to prevent property damage, injury to persons, or death.

- This appliance must be grounded. In the event of malfunction or breakdown, grounding will reduce the risk of electric shock by providing a path of least resistance for electric current.
- This appliance is equipped with a cord having an equipment-grounding conductor and grounding plug. The plug must be plugged into an appropriate outlet that is properly installed and grounded in accordance with all local codes and ordinances.
- Improper connection of the equipment-grounding conductor can result in risk of electric shock. Check with a qualified electrician or service person if you are in doubt as to whether the appliance is properly grounded.
- Do not modify the plug provided with the appliance. If it does not fit the outlet, have a proper outlet installed by a qualified electrician.

DISPOSAL OF YOUR OLD APPLIANCE



1. All electrical and electronic products should be disposed of separately from the municipal waste stream via designated collection facilities appointed by the government or the local authorities.
2. The correct disposal of your old appliance will help prevent potential negative consequences for the environment and human health.
3. For more detailed information about disposal of your old appliance, please contact your city office, waste disposal service or the shop where you purchased the product.

Important Safety Instructions

WARNING

To reduce the risk of fire, electric shock, or injury to persons when using your product, basic safety precautions should be followed, including the following.

Installation

- Never attempt to operate this appliance if it is damaged, malfunctioning, partially disassembled, or has missing or broken parts, including a damaged cord or plug. It can cause electric shock or injury.
- This appliance is heavy. Two or more people may be needed to install and move the appliance. Failure to do so can result in injury.
- Store and install this appliance where it will not be exposed to temperatures below freezing or exposed to outdoor weather conditions. Failure to do so can result in leakage.
- Tighten the drain hose to avoid separation. Splashing of water may cause electric shock.
- If the supply cord is damaged, it must be replaced by the manufacturer or its service agents or similarly qualified person in order to avoid a hazard.
- The appliance must not be installed behind a lockable door, a sliding door or a door with a hinge on the opposite side to that of the tumble dryer, in such a way that a full opening of the tumble dryer door is restricted.

Operation

- Do not use a sharp object like drill or pin to press or separate an operation unit. It can cause the electric shock or injury.
- Only an authorized repair person from LG Electronics service centre should disassemble, repair, or modify the product. Improper service may cause injury, electric shock or fire.
- Do not spray the water inside or outside the product to clean it. Water can damage the insulation, causing electric shock or fire.
- Keep the area underneath and around your appliances free of combustible materials such as lint, paper, rags, chemicals, etc. Improper use can cause fire or explosion.
- Do not put living animals, such as pets into the product. It may cause injury.
- Do not leave this appliance door open. Children may hang on the door or crawl inside the appliance, causing damage or injury.

- Never reach into this appliance while it is operating. Wait until the drum has completely stopped. Failure to do so may result in injury.
- Do not put in, wash or dry articles that have been cleaned in, washed in, soaked in, or spotted with combustible or explosive substances (such as wax, oil, paint, gasoline, degreasers, drycleaning solvents, kerosene, vegetable oil, cooking oil, etc.). Improper use can cause fire or explosion.
- In case of flood, stop using the product and contact the LG Electronics service centre. Contact with water can cause electric shock.
- Do not push down the door excessively, when the appliance door is open. Doing so may topple over the appliance and it can cause the injury.
- Use new hose-sets supplied with the appliance. Old hose-sets should not be reused. Water leakage may cause property damage.
- Do not touch the door during steam cycles, drying or high-temperature washing. The door surface can become very hot. Allow the door lock to release before opening the door. Failure to do so may result in injury.
- Do not use inflammable gas and combustible substances (benzene, gasoline, thinner, petroleum, alcohol, etc.) around the product. It may cause explosion or fire.
- If the drain hose or inlet hose is frozen during winter, use it only after thawing. Freezing may cause fire or electric shock, and frozen parts may cause product malfunction or reduction in product life span.
- Keep all washing detergents, softener and bleach away from children. These products contain poisonous materials.
- Do not plug multiple products into multiple socket-outlets or extension cords. This can cause fire.
- Remove the power plug when you clean the product. Not removing the plug may result in electric shock or injury.
- Do not touch the power plug with wet hands. It can cause the electric shock or injury.
- When pulling out the power plug from an outlet, hold the power plug, not the cable. Damage of the cable can cause the electric shock or injury.
- Do not bend the power cable excessively or place a heavy object on top of it. Damage of the power cable can cause electric shock or fire.

Technical Safety for Using the Tumble Dryer

- Do not dry unwashed items in the appliance.
- Items that have been soiled with substances such as cooking oil, vegetable oil, acetone, alcohol, petrol, kerosene, spot removers, turpentine, waxes and wax removers should be washed in hot water with an extra amount of detergent before being dried in the appliance.
- Fabric softeners or other similar products should be used according to the fabric softener instructions.
- Remove all objects from pockets such as lighters and matches.
- Never stop this appliance before the end of the drying cycle unless all items are quickly removed and spread out so that the heat is dissipated.
- This appliance is not to be used if industrial chemicals have been used for cleaning.
- Items such as foam rubber (latex foam), shower caps, waterproof textiles, rubber backed articles and clothes or pillows fitted with foam rubber pads should not be dried in this appliance.

Disposal

- Before discarding an old appliance, unplug it. Render the plug useless. Cut off the cable directly behind the appliance to prevent misuse.
- Dispose of the packaging material (such as vinyl and styrofoam) away from children. The packaging material can suffocate a child.
- Remove the door to the washing compartment before this appliance is removed from service or discarded to avoid the danger of children or small animals getting trapped inside. Failure to do so can result in serious injury to persons or death.

INSTALLATION

Specifications

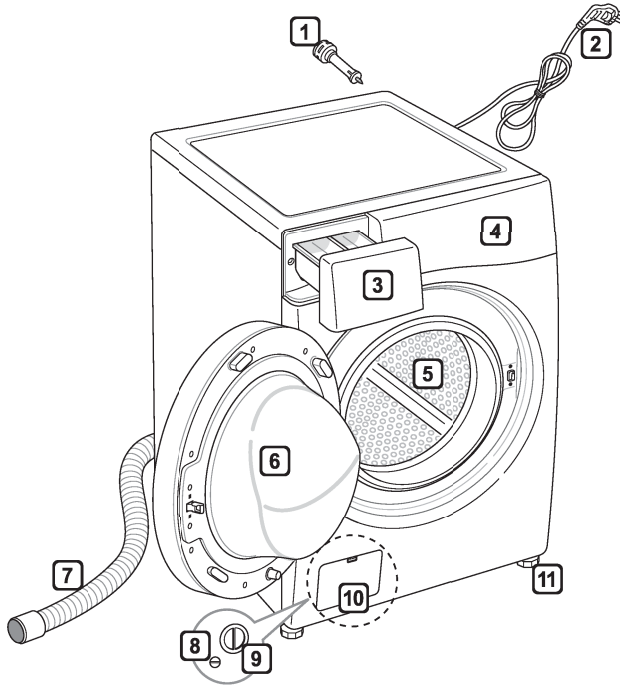

- 1 Transit bolts
- 2 Power plug
- 3 Drawer
- 4 Control panel
- 5 Drum
- 6 Door
- 7 Drain hose
- 8 Drain plug
- 9 Drain pump filter
- 10 Cover cap
(Location may vary depending on products)
- 11 Adjustable feet

- Power supply : 220–240 V~, 50 Hz
- Size : 600 mm (W) X 560 mm (D) X 850 mm (H)
- Product weight : 67 kg
- Wash Capacity : 8 kg (Wash) / 5 kg (Dry)
- Max.Watt : 2100W(Wash) / 1250W (Dry)
- Permissible water pressure : 0.1 - 1.0 MPa (1.0 - 10.0 kgf / cm²)

- Appearance and specifications may vary without notice to improve the quality of the product.

Accessories

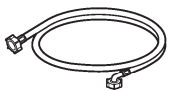

Inlet hose (1EA)
(Option: Hot (1EA))



Spanner



Caps for covering shipping
bolt holes



Anti-slip sheets (2EA)
(Optional)

Installation Place Requirements

Location

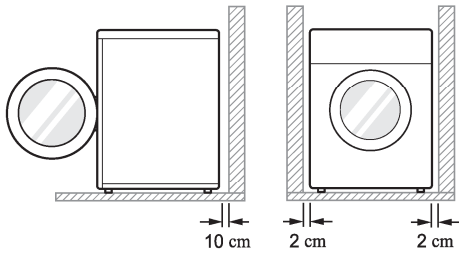

Level floor : Allowable slope under the entire washing machine is 1°.

Power outlet : Must be within 1.5 meters of either side of the location of the washing machine.

- Do not overload the outlet with more than one appliance.

Additional Clearance : For the wall, 10 cm: rear
/2 cm: right & left side

- Do not place or store laundry products on top of the washing machine at any time.
- These products may damage the finish or controls.

Positioning

- Install the washing machine on a flat hard floor.
- Make sure that air circulation around the washing machine is not impeded by carpets, rugs, etc.
- Never try to correct any unevenness in the floor with pieces of wood, cardboard or similar materials under the washing machine.
- If it is impossible to avoid positioning the washing machine next to a gas cooker or coal burning insulation (85x60 cm) covered with aluminum foil on the side facing the cooker or stove must be inserted between the two appliances.

- Do not install your washing machine in rooms where freezing temperatures may occur. Frozen hoses may burst under pressure. The reliability of the electronic control unit may be impaired at temperatures below freezing point.
- Please ensure that when the washing machine is installed, it is easily accessible for an engineer in the event of a breakdown.
- With the washing machine installed, adjust all four feet using the transit bolt spanner provided to ensure the appliance is stable, and a clearance of approximately 20 mm is left between the top of the washing machine and the underside of any work-top.
- This equipment is not designed for maritime use or for use in mobile installations such as caravans, aircraft etc.

Electrical Connection

- Do not use an extension cord or double adapter.
- Always unplug the washing machine and turn off the water supply after use.
- Connect the washing machine to an earthed socket in accordance with current wiring regulations.
- The washing machine must be positioned so that the plug is easily accessible.
- Repairs to the washing machine must only be carried out by qualified personnel. Repairs carried out by inexperienced persons may cause injury or serious malfunctioning. Contact your local service centre.
- If the washing machine is delivered in winter and temperatures are below freezing, place the washing machine at room temperature for a few hours before putting it into operation.

Unpacking and Removing Shipping Bolts

1 Lift the washing machine off the foam base.

- After removing the carton and shipping material, lift the washing machine off the foam base. Make sure the tub support comes off with the base and is not stuck to the bottom of the washing machine.
- If you must lay the washing machine down to remove the carton base, always protect the side of the washing machine and lay it carefully on its side. **DO NOT** lay the washing machine on its front or back.

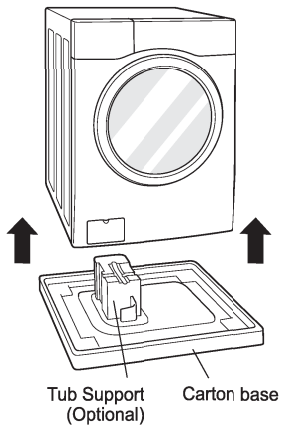

2 Remove the bolt assemblies.

- Starting with the bottom two shipping bolts, use the spanner (included) to fully loosen all shipping bolts by turning them counterclockwise. Remove the bolt assemblies by wiggling them slightly while pulling them out.

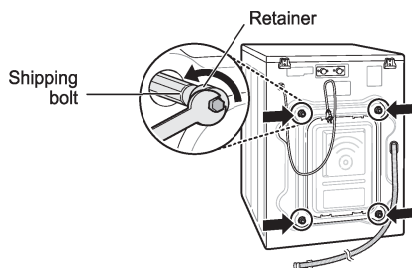

3 Install the hole caps.

- Locate the hole caps included in the accessory pack and install them in the shipping bolt holes.

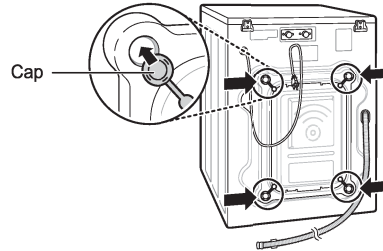

NOTE

- Save the bolt assemblies for future use. To prevent damage to internal components, **DO NOT** transport the washing machine without reinstalling the shipping bolts.
- Failure to remove shipping bolts and retainers may cause severe vibration and noise, which can lead to permanent damage to the washing machine. The cord is secured to the back of the washing machine with a shipping bolt to help prevent operation with shipping bolts in place.

Using Non-Skid Pads (Optional)

If you install the washing machine on a slippery surface, it may move because of excessive vibration. Incorrect leveling may cause malfunction through noise and vibration. If this occurs, install the non-skid pads under the leveling feet and adjust the level.

- 1 Clean the floor to attach the non-skid pads.
 - Use a dry rag to remove and clean foreign objects and moisture. If moisture remains, the non-skid pads may slip.
- 2 Adjust the level after placing the washing machine in the installation area.
- 3 Place the adhesive side of the non-skid pad on the floor.
 - It is most effective to install the non-skid pads under the front legs. If it is difficult to place the pads under the front legs, place them under the back legs.

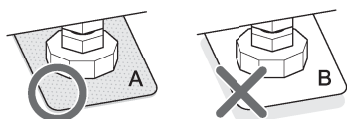
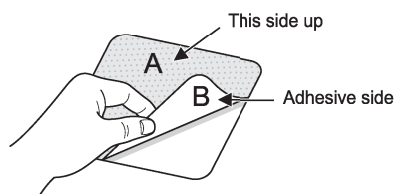

- 4 Ensure the washing machine is level.
 - Push or rock the top edges of the washing machine gently to make sure that the washing machine does not rock. If the washing machine rocks, level the washing machine again.

Wooden Floors (Suspended Floors)

- Wooden floors are particularly susceptible to vibration.
- To prevent vibration we recommend you place rubber cups at least 15 mm thick of the each foot of the washing machine, secured to at least two floor beams with screws.

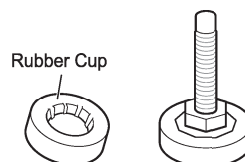

- If possible install the washing machine in one of the corners of the room, where the floor is more stable.
- Fit the rubber cups to reduce vibration.
- You can obtain rubber cups (p/no.4620ER4002B) from the LG Service Centre.

NOTE

- Proper placement and leveling of the washing machine will ensure long, regular, and reliable operation.
- The washing machine must be 100% horizontal and stand firmly in position.
- It must not 'Seesaw' across corners under the load.
- The installation surface must be clean, free from floor wax and other lubricant coatings.
- Do not let the feet of the washing machine get wet. Failure to do so may cause vibration or noise.

Leveling the Washing Machine

If the floor is uneven, turn the adjustable feet as required (Do not insert pieces of wood etc. under the feet). Make sure that all four feet are stable and resting on the floor and then check that the appliance is perfectly level (Use a spirit level).

- Once the washing machine is level, tighten the lock nuts up towards the base of the washing machine. All lock nuts must be tightened.

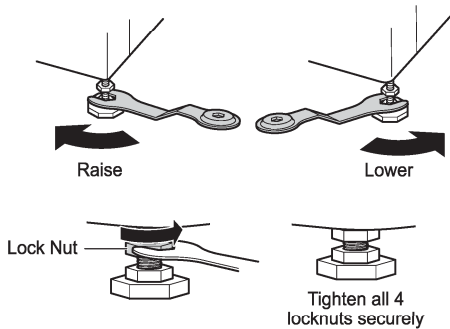

- **Diagonal Check**

When pushing down the edges of the washing machine top plate diagonally, the washing machine should not move up and down at all (Check both directions). If the washing machine rocks when pushing the machine top plate diagonally, adjust the feet again.

NOTE

- Timber or suspended type flooring may contribute to excessive vibration and unbalance.
- If the washing machine is installed on a raised platform, it must be securely fastened in order to eliminate the risk of falling off.

Connecting Inlet Hose

- Water supply pressure must be between 0.1 MPa and 1.0 MPa (1.0–10.0 kgf/cm²).
- Do not strip or crossthread when connecting inlet hose to the valve.
- If the water supply pressure is more than 1.0 MPa, a decompression device should be installed.
- Periodically check the condition of the hose and replace the hose if necessary.

Checking Rubber Seal Inlet Hose

Two rubber seals are supplied with the water inlet hoses. They are used for preventing water leaks. Make sure the connection to taps is sufficiently tight.

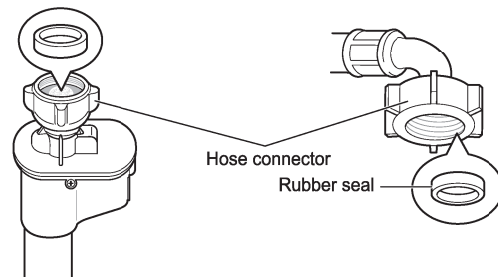
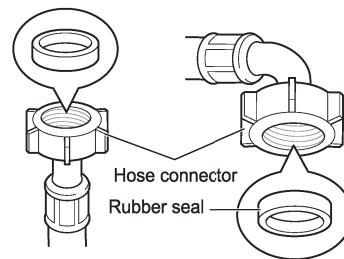

Connecting Hose to Water Tap

Connecting screw-type hose to tap with thread

Screw the hose connector onto the water supply tap.

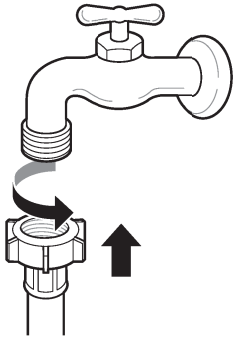

- 3 Push the inlet hose vertically upwards so that the rubber seal within the hose can adhere completely to the tap and then tighten it by screwing it to the right.

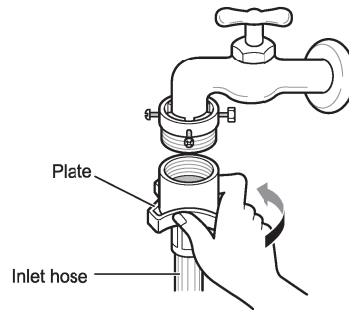

Connecting screw-type hose to tap without thread

- 1 Loose the four fixing screws.

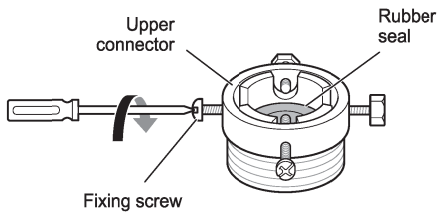

- 2 Push the adapter onto the end of the tap so that the rubber seal forms a watertight connection. Tighten the four fixing screws.

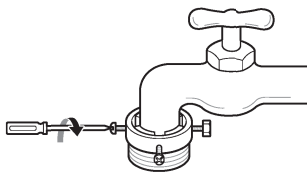

Connecting one touch type hose to tap without thread

- 1 Unscrew the adapter ring plate and loose the four fixing screws.

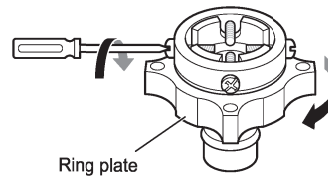

- 2 Remove the guide plate if the tap is too large to fit the adapter.

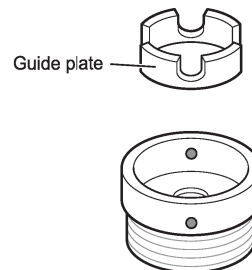

- 3** Push the adapter onto the end of the tap so that the rubber seal forms a watertight connection. Tighten the adapter ring plate and the four fixing screws.

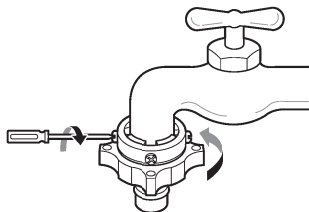

- 4** Pull the connector latch plate down, push the inlet hose onto the adapter, and release the connector latch plate. Make sure the adapter locks into place.

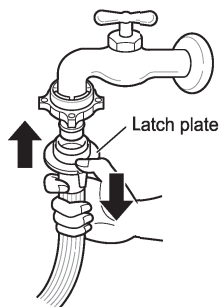

NOTE

- After connecting the inlet hose to the water tap, turn on the water tap to flush out foreign substances (dirt, sand, sawdust, etc.) in the water lines. Let the water drain into a bucket, and check the water temperature.

Connecting Hose to Washing Machine

Make sure that there are no kinks in the hose and that they are not crushed.

When your washing machine has two valves.

- The Inlet hose with the red connector is for the hot water tap.

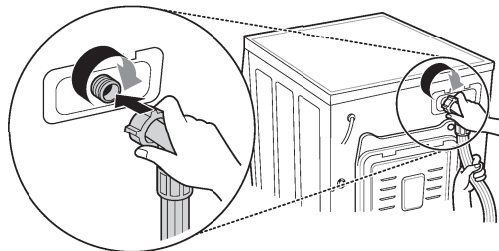

NOTE

- After completing connection, if water leaks from the hose, repeat the same steps. Use the most conventional type of tap for the water supply. In case the tap is square or too big, remove the guide plate before inserting the tap into the adaptor.

Using the horizontal tap

Horizontal tap



Extension tap

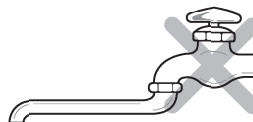

Square tap



Installation of Drain Hose

- The drain hose should not be placed higher than 100 cm above the floor. Water in the washing machine may not drain or may drain slowly.
- Securing the drain hose correctly will protect the floor from damage due to water leakage.
- If the drain hose is too long, do not force it back into the washing machine. This will cause abnormal noise.

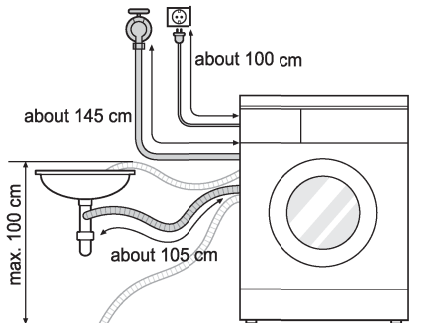

- When installing the drain hose to a sink, secure it tightly with string.
- Securing the drain hose correctly will protect the floor from damage due to water leakage.

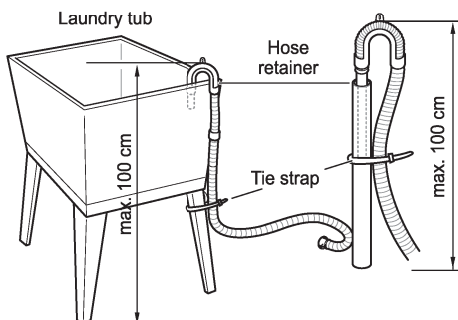
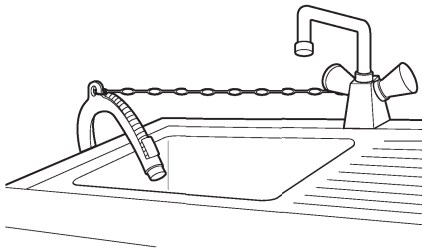

Electrical Connections (In the UK Only)

The wires in the mains lead are coloured in accordance with the following code:

Green and Yellow: Earth

Blue: Neutral

Brown: Live

This appliance must be earthed.

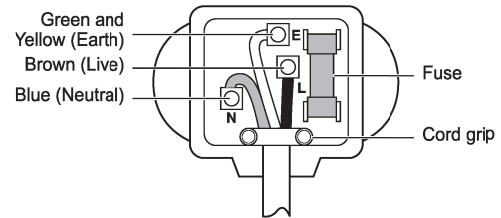

As the colours of the wires in the mains lead of this apparatus may not correspond with the coloured markings identifying the terminals in your plug, proceed as follows:

The green and yellow wire must be connected to the terminal in the plug which is marked with the letter E or by the earth symbol (\perp) or coloured Green or Green and Yellow.

The blue wire must be connected to the terminal which is marked with the letter N or coloured Black.

The brown wire must be connected to the terminal which is marked with the letter L or coloured Red.

If a 13 amp (BS 1363) plug is used, fit a 13 amp BS 1362 fuse.

OPERATION

Using the Washing Machine

Before the first wash, select a cycle (Cotton 60 °C, add a half load of detergent), allow the washing machine to wash without clothing. This will remove residue and water from the drum that may have been left during manufacturing.

- 1 Sort laundry and load items.
 - Sort laundry by fabric type, soil level, colour and load size as needed. Open the door and load items into the washing machine.

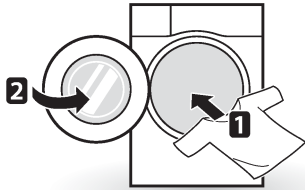

- 2 Add cleaning products and/or detergent and softener.
 - Add the proper amount of detergent to the detergent dispenser drawer. If desired, add bleach or fabric softener to the appropriate areas of the dispenser.

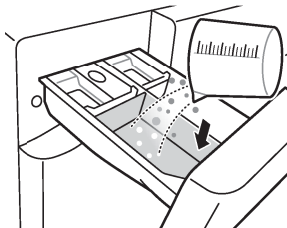

- 3 Turn on the washing machine.
 - Press the **Power** button to turn ON the washing machine.

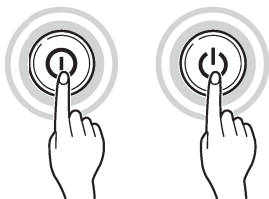

- 4 Choose the desired washing cycle.
 - Press the Cycle button repeatedly or turn the cycle selector knob until the desired cycle is selected.

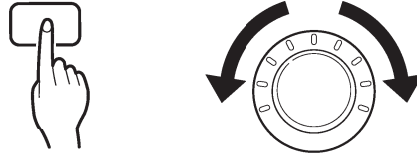

- 5 Begin cycle.
 - Press the **Start/Pause** button to begin the cycle. The washing machine will agitate briefly without water to measure the weight of the load. If the **Start/Pause** button is not pressed within 5 minutes, the washing machine will shut off and all settings will be lost.



- 6 End of cycle.
 - When the cycle is finished, a melody will sound. Immediately remove your clothing from the washing machine to reduce wrinkling. Check around the door seal when removing the load for small items that may be caught in the seal.

Sorting laundry

1 Look for a care label on your clothes.

- This will tell you about the fabric content of your garment and how it should be washed.
- Symbols on the care labels.

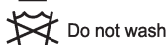
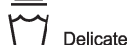
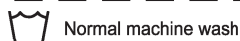

2 Sorting laundry.

- To get the best results, sort clothes into loads that can be washed with the same wash cycle.
- Different fabrics need to be washed at varying temperatures and spin speeds.
- Always sort dark colours from pale colours and whites. Wash separately as dye and lint transfer can occur causing discolouration of white and pale garments. If possible, do not wash heavily soiled items with lightly soiled ones.
 - Soil (Heavy, Normal, Light)
Separate clothes according to amount of soil.
 - Colour (White, Lights, Darks)
Separate white fabrics from coloured fabrics.
 - Lint (Lint producers, Collectors)
Wash lint producers and lint collectors separately.

3 Caring before loading.

- Combine large and small items in a load. Load large items first.
- Large items should not be more than half the total wash load. Do not wash single items. This may cause an unbalanced load. Add one or two similar items.
- Check all pockets to make sure that they are empty. Items such as nails, hair clips, matches, pens, coins and keys can damage both your washing machine and your clothes.

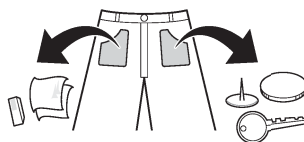

- Close zippers, hooks and strings to make sure that these items don't snag on other clothes.
- Pre-treat dirt and stains by brushing a small amount of detergent dissolved water onto stains to help lift dirt.
- Check the folds of the flexible gasket (gray) and remove any small articles.
- Check inside the drum and remove any items from a previous wash.

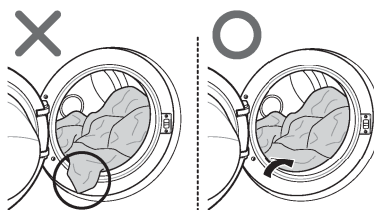

- Remove any clothing or items from the flexible gasket to prevent clothing and gasket damage.

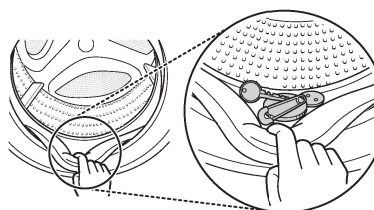

Adding Cleaning Products

Detergent Dosage



- Detergent should be used according to the instruction of the detergent manufacturer and selected according to type, colour, soiling of the fabric and washing temperature.
- If too much detergent is used, too many suds can occur and this will result in poor washing results or cause heavy load to the motor.
- If you wish to use liquid detergent follow the guidelines provided by the detergent manufacturer.
- You can pour liquid detergent directly into the main detergent drawer if you are starting the cycle immediately.
- Do not use liquid detergent if you are using Time Delay, or if you have selected Pre Wash, as the liquid may harden.
- If too many suds occur, reduce the detergent amount.
- Detergent usage may need to be adjusted for water temperature, water hardness, size and soil level of the load. For best results, avoid oversudsing.
- Refer to the label of the clothes, before choosing the detergent and water temperature:
- When using the washing machine, use designated detergent for each type of clothing only:
 - General powdered detergents for all types of fabric
 - Powdered detergents for delicate fabric
 - Liquid detergents for all types of fabric or designated detergents only for wool
- For better washing performance and whitening, use detergent with the general powdered bleach.
- Detergent is flushed from the dispenser at the beginning of the cycle.

NOTE

- Do not let the detergent harden. Doing so may lead to blockages, poor rinse performance or odour.
- Full load : According to manufacturer's recommendation.
- Part load : 3/4 of the normal amount
- Minimum load : 1/2 of full load

Adding Detergent and Fabric Softener

Adding detergent

- Main wash only → 
- Pre wash+Main wash →  • 

NOTE

- Too much detergent, bleach or softener may cause an overflow.
- Be sure to use the appropriate amount of detergent.

Adding fabric softener

- Do not exceed the maximum fill line. Overfilling can cause early dispensing of the fabric softener, which may stain clothes. Close the dispenser drawer slowly.

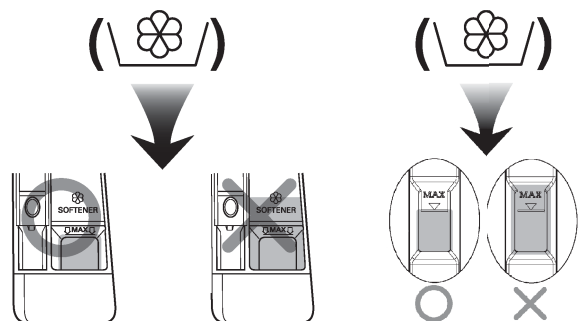

- Do not leave the fabric softener in the detergent drawer for more than 2 days (Fabric softener may harden).
- Softener will automatically be added during the last rinse cycle.
- Do not open the drawer when water is being supplied.
- Solvents (benzene, etc) should not be used.

NOTE

- Do not pour fabric softener directly on the clothes.

Adding water softener

- A water softener, such as Anti-limescale (e.g. Calgon) can be used to cut down on the use of detergent in extremely hard water areas. Dispense according to the amount specified on the packaging. First add detergent and then the water softener.
- Use the quantity of detergent required for soft water.

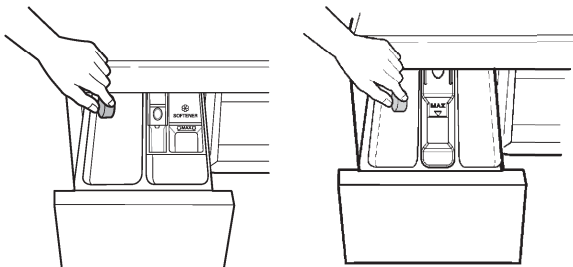

Using tablet

- 1 Open the door and put tablets into the drum.

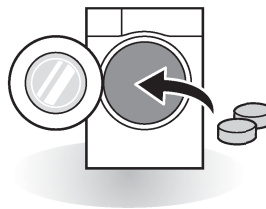

- 2 Load the laundry into the drum and close the door.

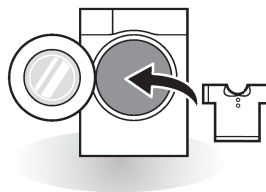

Control Panel

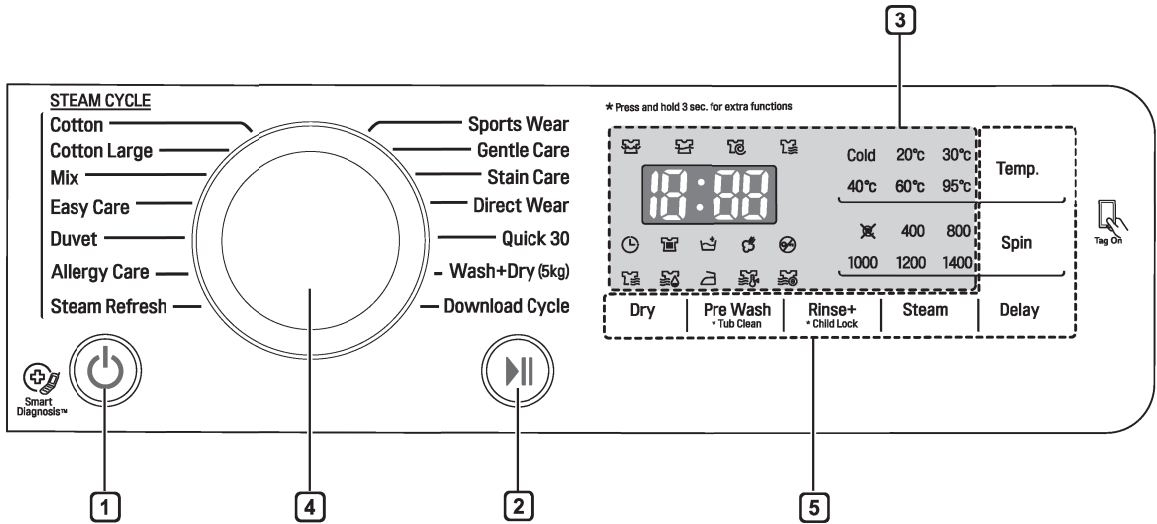

1 Power button

- Press the **Power** button to turn the washing machine on.
- To cancel the Time Delay function, the power button should be pressed.

2 Start/Pause button

- This **Start/Pause** button is used to start the wash cycle or pause the wash cycle.
- If a temporary stop of the wash cycle is needed, press the **Start/Pause** button.

3 Display

- The display shows the settings, estimated time remaining, options, and status messages. When the product is turned on, the default settings in the display will illuminate.
- The display shows estimate time remaining. While the size of the load is being calculated automatically, blinking  or 'Detecting' appears.

4 Programme dial

- Programmes are available according to laundry type.
- Lamp will light up to indicate the selected programme.

5 Options

- This allows you to select an additional cycle and will light when selected.
- Use these buttons to select the desired cycle options for the selected cycle.

Programme Table

Washing Programme

Programme	Description	Fabric Type	Proper Temp.	Maximum Load
Cotton	Provides better performance by combining various drum motions.	Coloured fast garments (shirts, nightdresses, pajamas, etc) and normally soiled cotton load (underwear).	40°C (Cold to 95°C)	Rating
Cotton Large	Provides optimised washing performance for large amount of laundry with less energy consumption.		60°C (Cold to 60°C)	
Easy Care	This cycle is suitable for casual shirts that do not need ironing after washing.	polyamide, acrylic, polyester	40°C (Cold to 60°C) ⁴	4.5 kg
Mix	Enables various fabrics to be washed simultaneously.	Various kind of fabrics except special garments (silk/delicate, sports wear, dark clothes, wool, duvet/curtains).	40°C (Cold to 40°C)	
Allergy Care	Helps to remove allergens such as house mites, pollen, and cat fur.	cotton, underwear, pillow covers, bed sheets, baby wear	60 °C	
Direct Wear	This cycle provides washing to drying within 80mins at once for light soiled 1–3 shirts.	cotton mixed, polyester mixed dress shirts, blouses	30 °C	
Steam Refresh	Helps to remove wrinkles within 20mins with steam (Clothes may be wet. You can put them on after hang out to dry for 10–30min).	cotton mixed, polyester mixed dress shirts, blouses	No choice	3 items
Duvet	This cycle is for large items such as bed covers, pillows, sofa covers, etc.	Cotton bedding except special garments (delicates, wool, silk, etc.) with filling: duvets, pillows, blankets, sofa covers with light filling	40°C (Cold to 40°C)	1 single size
Sports Wear	This cycle is suitable for sports wear such as jogging clothes and running wear.	coolmax, gore-tex, fleece and sympatex		3.0 kg
Quick 30	This cycle provides a fast washing time for small loads and lightly soiled clothes.	Lightly soiled colour laundry.	30°C (Cold to 40°C)	









Programme	Description	Fabric Type	Proper Temp.	Maximum Load
Wash+ Dry	This cycle provides a nonstop process of washing and drying in the same cycle.	A small amount of laundry which can be dried.	40°C (Cold to 95°C)	5.0 kg
Gentle Care	This cycle is for hand and machine washable delicate clothes such as washable wool, lingerie, dresses etc. (Use detergent for machine washable woolens).	wool, hand washable clothes, delicate, easily damaged laundry	20°C (Cold to 20°C)	1.5 kg
Stain Care	Wash off several kinds of stain such as wine, juice, dirt, etc. (Water temperature is increased step by step for washing various stains.)	cotton blended fabrics, NO delicate clothes	40°C (30°C to 60°C)	3.0 kg
Download Cycle	For downloadable cycles. If you did not download any cycles, the default is Rinse+Spin.			

- Water Temperature: Select the appropriate water temperature for chosen wash cycle. Always follow garment manufacturer's care label or instructions when washing.

NOTE

- Neutral detergent is recommended.

Drying Programme

Programme	Description	Fabric Type	Maximum Load
ECO ()	A special cycle to reduce water usage during the dry cycle.	Cotton or linen fabrics such as cotton towels, t-shirts, and linen laundries.	5.0 kg
Cupboard ()	For cottons. Select this cycle to reduce cycle time and energy usage during the dry cycle.		
Normal Eco ()	For energy dry cycle.		
Iron ()	For easy iron, finish drying in damp condition.	Cotton or linen fabrics, ready to iron at the end of cycle.	
Low Temp. ()	For less clothes damage, it dries in low temperature.	easy care textiles, synthetic fabrics suitable for Easy Care, Mix programme washable clothes	
Time 30 min. ()	You can change the drying time according to the maximum load.	cotton, towel	0.5 kg
Time 60 min. ()			1.5 kg
Time 120 min. ()			3.0 kg

- Set programme at 'Wash: Cotton Large 60 °C+1400 rpm' and 'Dry: Normal Eco Dry (First drying cycle load: 4.0 kg, Second drying cycle load: 4.0 kg)' to test in accordance with EN50229.

NOTE

- Select maximum selectable spin speed of washing programme to ensure drying results.
- Where the amount of laundry to be washed and dried in one programme does not exceed the maximum weight permitted for the drying programme, washing and drying in one continuous sequence is recommended.

Extra Options

Programme	Delay	Steam	Pre Wash	Rinse+	Dry
Cotton	●	●	●	●	●
Cotton Large	●	●	●	●	●
Easy Care	●	●	●	●	●
Mix	●	●	●	●	●
Allergy Care	●	●*		●	●
Direct Wear	●				●*
Steam Refresh		●*			
Duvet	●	●		●	
Sports Wear	●			●	
Quick 30	●		●	●	●
Gentle Care	●			●	
Wash+Dry	●	●	●	●	●*
Stain Care	●		●*	●	●

* : This option is automatically included in the cycle and can not be deleted.

Operating Data

Programme	Max RPM
Cotton	1400
Cotton Large	1400
Easy Care	1200
Mix	1400
Allergy Care	1400
Direct Wear	1000
Steam Refresh	-
Duvet	1000
Sports Wear	800
Quick 30	1400
Gentle Care	800
Wash+Dry	1400
Stain Care	1200

Option Cycle

Pre Wash ()

If the laundry is heavily soiled, the Pre Wash cycle is recommended.

- 1 Press the **Power** button.
- 2 Select a washing programme.
- 3 Press the **Pre Wash** button.
- 4 Press the **Start/Pause** button.

Steam (Optional) ()

Steam Wash features enhanced washing performance with low energy consumption. Steam Softener sprays steam after a spinning cycle to reduce creases and make the laundry fluffy.

- 1 Press the **Power** button.
- 2 For Steam Wash option, select steam cycles. For Steam Softener option, select Cotton or Cotton Large, Mix, Easy Care.
- 3 The following cycle is selected depending on the number of times you press the **Steam** button.
 - Once: Steam Wash
 - Twice: Steam Softener
 - Three times: Steam Wash and Steam Softener
- 4 Press the **Start/Pause** button.

Delay ()

You can set a time delay so that the washing machine will start automatically and finish after a specified time interval.

- 1 Press the **Power** button.
- 2 Select a washing programme.
- 3 Press the **Delay** button and set time required.
- 4 Press the **Start/Pause** button.

NOTE

- The delay time is the time to the end of the programme, not the start. The actual running time may vary due to water temperature, wash load and other factors.

Temp.

The **Temp.** button selects the wash and rinse temperature combination for the selected cycle. Press this button until the desired setting is lit. All rinses use cold tap water.

- Select the water temperature suitable for the type of load you are washing. Follow the garment fabric care labels for best results.

Rinse⁺

Rinse⁺ (🔄⁺)

Add rinse once.

Spin

- Spin speed level can be selected by pressing the **Spin** button repeatedly.

- Spin Only

- 1 Press the **Power** button.
- 2 Press the **Spin** button to select RPM.
- 3 Press the **Start/Pause** button.

NOTE

- When you select 'No Spin' (🔄~~+~~), it will still rotate for a short time to drain quickly.

Child Lock (🔒)

Select this function to lock the buttons on the control assembly to prevent tampering.

Locking the control panel

- 1 Press and hold the **Child Lock** button for 3 seconds.
- 2 A beeper will sound, and 'L' will appear on the display.
When the child lock is set, all buttons are locked except the **Power** button.

NOTE

- Turning off the power will not reset the child lock function. You must deactivate child lock before you can access any other functions.

Unlocking the control panel

Press and hold the **Child Lock** button for 3 seconds.

- A beeper will sound and the remaining time for the current programme will reappear on the display.

Beep On / Off

- 1 Press the **Power** button.
- 2 Press the **Start/Pause** button.
- 3 Press and hold the **Temp.** and **Steam** button simultaneously for 3 seconds to set the Beep on/off function.

NOTE

- Once the Beep on/off function is set, the setting is memorized even after the power is turned off.
- If you want to turn the Beeper off, simply repeat this process.

Dry (Optional) ()

Use the your Automatic cycles to dry most loads. Electronic sensors measure the temperature of the exhaust to increase or decrease drying temperatures for faster reaction time and tighter temperature control.

- Cold water tap must be left on during drying cycles.
- This washing machine's automatic process from washing to drying can be selected easily.
- For most even drying, make sure all articles in the clothes load are similar in material and thickness.
- Do not overload the washing machine by stuffing too many articles into the drum. Items must be able to tumble freely.
- If you open the door and remove the load before the washing machine has finished its cycle, remember to press the **Start/Pause** button.
- By pressing the **Dry** button, you can select: Cupboard-Time (30-60-120)-Eco-Iron-Low Temp.-Normal Eco Dry
- After the end of dry, 'LD' is displayed. 'LD' means crease decreasing. The drying cycle is already done. Press any buttons and take out clothes. If you do not press the **Start/Pause** button, the programme ends after about 4 hours.

NOTE

- When you turn the washing machine off of the drying cycle, the drying fan motor can be operated to save itself for 30 seconds. Then the washing machine will display 'LF' on the panel. 'LF' means cooling fan.
- Be careful when removing your clothing from the washing machine, as the clothing or washing machine may be hot.

Woolen Articles

- Do not tumble dry woolen articles. Pull them to their original shape and dry them flat.

Woven and Loopknit Materials

- Some woven and loopknit materials may shrink, by varying amounts, depending on their quality.
- Always stretch these materials out immediately after drying.

Permanent Press and Synthetics

- Do not overload your washing machine
- Take out permanent press articles as soon as the washing machine stops to reduce wrinkles.

Baby clothes and Night Gowns

- Always check the manufacturer's instructions.

Rubber and Plastics

- Do not dry any items made from or containing rubber or plastics, such as:
 - aprons, bibs, chair covers
 - curtains and table cloths
 - bathmats

Fiber glass

- Do not dry fiberglass articles in your washing machine. Glass particles left in the washing machine may be picked up by your clothes the next time you use the washing machine and cause skin irritation.

Drying Time Guide

- The drying time can be selected by pressing the **Dry** button.
- Drying cycle can last up to 364 min.
- These drying times are given as a guide to help you set your washing machine for manual drying.

NOTE

- The estimated drying time varies from the actual drying time during the Automatic cycle. The type of fabric, size of the load, and the dryness selected affect drying time.
- When you select drying only, spinning runs automatically for energy efficiency.

Using Smart Function (Optional)

Using the Tag On Function

The Tag On function allows you to conveniently use the LG Smart Diagnosis™ and Cycle Download features to communicate with your appliance right from your own smart phone.

- The Tag On function can only be used with most smart phones equipped with the NFC function and based on the Android operating system (OS).

Installation of the application

- Search "LG Smart Laundry" on the Google Play Store from your smart phone.

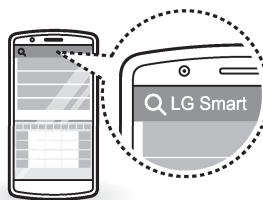

Using the Application

LG Smart Laundry application allows you to use various features for your convenience.

- Cycle Download
- Smart Diagnosis™
- Tag On Cycle Set
- Laundry Stats

NOTE

- Press **?** in the LG Smart Laundry application for a more detailed guide on how to use the Tag On function.
- Depending on the smart phone manufacturer and Android OS version, the NFC activation process may differ. Refer to the manual of your smart phone for details.
- Because of the characteristics of NFC, if the transmission distance is too far, or if there is a metal sticker or a protective case on the phone, transmission will not be good. In some cases, NFC-equipped phones may be unable to transmit successfully.
- The content found in this manual may differ depending on the version of "LG Smart Laundry" application, and it may be modified without informing customers.

EU Conformity Notice



LG Electronics hereby declares that this product is in compliance with the following Directives.

R&TTE Directive 1999/5/EC

WARNING

- Unplug the washing machine before cleaning to avoid the risk of electric shock. Failure to follow this warning may result in serious injury, fire, electric shock, or death.
- Never use harsh chemicals, abrasive cleaners, or solvents to clean the washing machine. They may damage the finish.

Cleaning your Washing Machine

Care After Wash

- After the cycle is finished, wipe the door and the inside of the door seal to remove any moisture.
- Leave the door open to dry the drum interior.
- Wipe the body of the washing machine with a dry cloth to remove any moisture.

Cleaning the Exterior

Proper care of your washing machine can extend its life.

Door:

- Wash with a damp cloth on the outside and inside and then dry with a soft cloth.

Exterior:

- Immediately wipe off any spills.
- Wipe with a damp cloth.
- Do not press the surface or the display with sharp objects.

Care and Cleaning of the Interior

- Use a towel or soft cloth to wipe around the washing machine door opening and door glass.
- Always remove items from the washing machine as soon as the cycle is complete. Leaving damp items in the washing machine can cause wrinkling, colour transfer, and odour.
- Run the Tub Clean cycle once a month (or more often if needed) to remove detergent buildup and other residue.

Cleaning the Water Inlet Filter

- Turn off the stopcock if the washing machine is to be left for any length of time (e.g. holiday), especially if there is no floor drain (gully) in the immediate vicinity.
- 'E' icon will be displayed on the control panel when water is not entering the detergent drawer.
- If water is very hard or contains traces of lime deposit, the water inlet filter may become clogged. It is therefore a good idea to clean it occasionally.

- 1 Turn off the water tap and unscrew the water inlet hose.

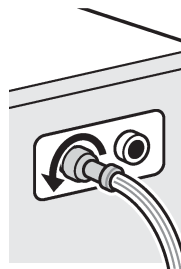

- 2 Clean the filter using a hard bristle brush.

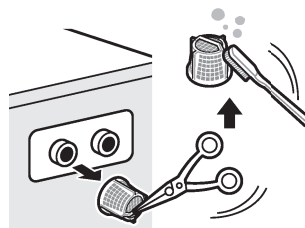

Cleaning the Drain Pump Filter

- The drain filter collects threads and small objects left in the laundry. Check regularly that the filter is clean to ensure smooth running of your washing machine.
- Allow the water to cool down before cleaning the drain pump, carrying out emergency emptying, or opening the door in an emergency.

1 Open the cover cap and pull out the hose.

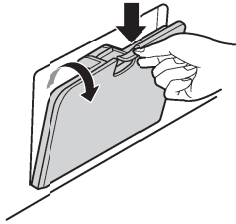

2 Unplug the drain plug and open the filter by turning it to the left.

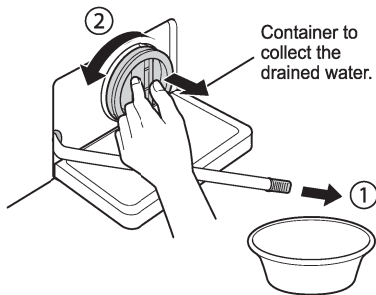

3 Remove any extraneous matter from the pump filter.

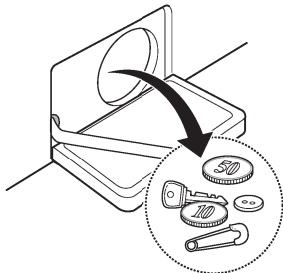

4 After cleaning, turn the pump filter and insert the drain plug.

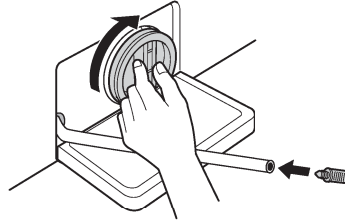

5 Close the cover cap.

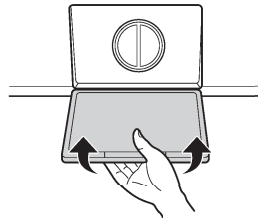

CAUTION

- First drain using the drain hose and then open the pump filter to remove any threads or objects.
- Be careful when draining, as the water may be hot.

Cleaning the Dispenser Drawer

Detergent and fabric softener may build up in the dispenser drawer. Remove the drawer and inserts and check for buildup once or twice a month.

- 1 Remove the detergent dispenser drawer by pulling it straight out until it stops.
 - Press down hard on the disengage button and remove the drawer.

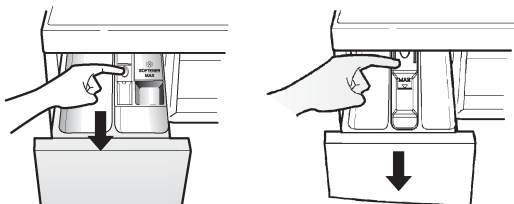

- 2 Remove the inserts from the drawer.
 - Rinse the inserts and the drawer with warm water to remove buildup from laundry products. Use only water to clean the dispenser drawer. Dry the inserts and drawer with a soft cloth or towel.
- 3 To clean the drawer opening, use a cloth or small, non-metal brush to clean the recess.
 - Remove all residue from the upper and lower parts of the recess.
- 4 Wipe any moisture off the recess with a soft cloth or towel.
- 5 Return the inserts to the proper compartments and replace the drawer.

Tub Clean (Optional)

Tub Clean is a special cycle to clean the inside of the washing machine.

A higher water level is used in this cycle at higher spin speed. Perform this cycle regularly.

- 1 Remove any clothing or items from the washing machine and close the door.
- 2 Open the dispenser drawer and add Anti limescale (e.g. Calgon) to the main wash compartment.
- 3 Close the dispenser drawer slowly.
- 4 Power On and then press and hold **Tub Clean** button for 3 seconds. Then 'tcl' will be displayed on the display.
- 5 Press the **Start/Pause** button to start.
- 6 After the cycle is complete, leave the door open to allow the washing machine door opening, flexible gasket and door glass to dry.

CAUTION

- If there is a child, be careful not to leave the door open for too long.

NOTE

- Do not add any detergent to the detergent compartments. Excessive suds may generate and leak from the washing machine.

Caution on Freezing During Winter

- When frozen, the product does not operate normally. Make sure to install the product where it will not freeze during winter.
- In case the product must be installed outside on a porch or in other outdoor conditions, make sure to check the following.

- After closing the tap, disconnect the cold inlet hose from the tap, and remove water while keeping the hose facing downwards.

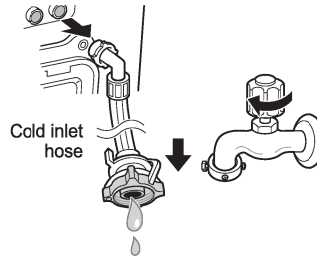

How to Keep the Product from Freezing

- After washing, remove water remaining inside the pump completely with the opening hose plug used for removal of residual water. When the water is removed completely, close the hose plug used for removal of residual water and cover cap.

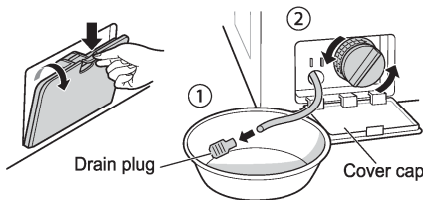

- Hang down drain hose to pull out water inside the hose completely.

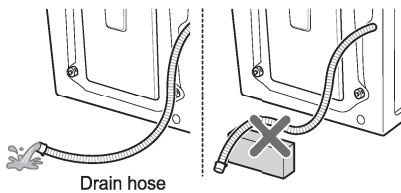

⚠ CAUTION

- When the drain hose is installed in a curved shape, the inner hose may freeze.

Check for Freezing

- If water does not drain when opening the hose plug used for removal of residual water, check the drainage unit.



- Turn the power on, select Rinse and Spin, and press the **Start/Pause** button.

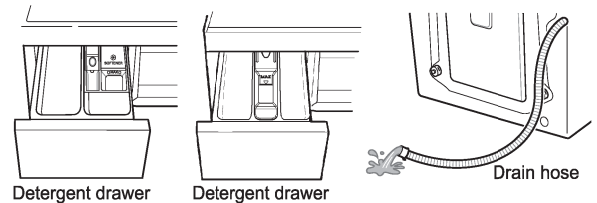

NOTE

- Check that water is coming into the detergent drawer while rinsing, and water is draining through the drain hose while spinning.
- When 'FF' is shown in display window while the product is in operation, check water supply unit and drainage unit (Some models do not have an alarm function that indicates freezing).

How to Handle Freezing

- Make sure to empty the drum, pour warm water of 50–60 °C up to the rubber part inside the drum, close the door, and wait for 1–2 hours.

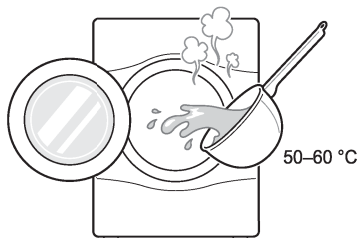

CAUTION

- Do not use boiling water. It may cause burns or damage to the product.
- Open the cover cap and hose plug used for removal of residual water to extract water completely.

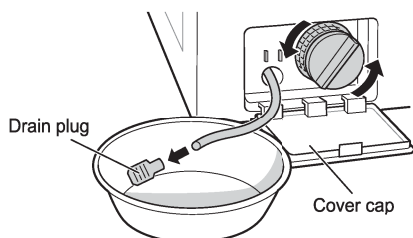

NOTE

- If when water does not drain, this means the ice is not melted completely. Wait more.

- When water is removed completely from the drum, close the hose plug used for removal of residual water, select Rinse and Spin, and press the **Start/Pause** button.

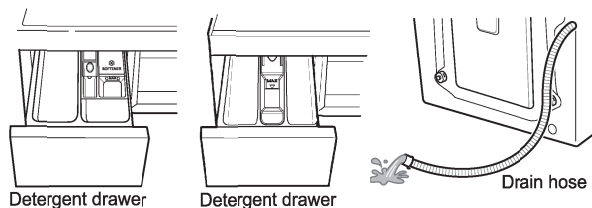

NOTE

- Check that water is coming into the detergent drawer while rinsing, and water is draining through the drain hose while spinning.
- When water supply problems occur, take the following measures.
 - Turn off the tap, and thaw out the tap and both connection areas of inlet hose of the product using a hot water cloth.
 - Take out inlet hose and immerse in warm water below 50–60 °C.

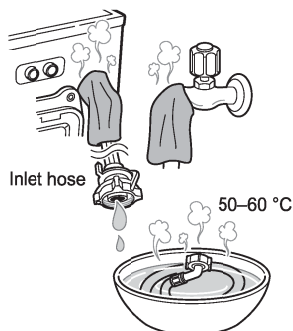

Using the Smart Diagnosis™ Function

Use this function if you need an accurate diagnosis by an LG Electronics service centre when the product malfunctions or fails. Use this function only to contact the service representative, not during normal operation.

- 1 Press the **Power** button to turn on the washing machine. Do not press any other buttons or turn the cycle selector knob.
- 2 When instructed to do so by the call centre, place the mouthpiece of your phone close to the **Power** button.

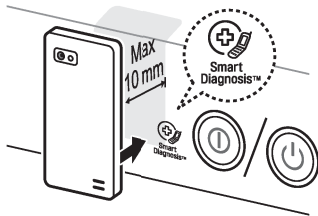

- 3 Press and hold the **Temp.** button for 3 seconds, while holding the phone mouthpiece to the icon or **Power** button.
- 4 Keep the phone in place until the tone transmission has finished. Time remaining for data transfer is displayed.
 - For best results, do not move the phone while the tones are being transmitted.
 - If the call centre agent is not able to get an accurate recording of the data, you may be asked to try again.



- 5 Once the countdown is over and the tones have stopped, resume your conversation with the call centre agent, who will then be able to assist you using the information transmitted for analysis.

NOTE

- The Smart Diagnosis™ function depends on the local call quality.
- The communication performance will improve and you can receive better service if you use the home phone.
- If the Smart Diagnosis™ data transfer is poor due to poor call quality, you may not receive the best Smart Diagnosis™ service.

TROUBLESHOOTING







- Your washing machine is equipped with an automatic error-monitoring system to detect and diagnose problems at an early stage. If your washing machine does not function properly or does not function at all, check the following before you call for service:















Diagnosing Problems

Symptoms	Reason	Solution
Rattling and clanking noise	Foreign objects such as coins or safety pins may be in drum or pump.	<ul style="list-style-type: none"> • Stop washing machine, check drum and drain filter. • If noise continues after washing machine is restarted, call your authorised service centre.
Thumping sound	Heavy wash loads may produce a thumping sound. This is usually normal.	<ul style="list-style-type: none"> • If sound continues, washing machine is probably out of balance. Stop and redistribute wash load.
Vibrating noise	Have all the transit bolts and tub support been removed?	<ul style="list-style-type: none"> • If not removed during installation, refer to Installation guide for removing transit bolts.
	Are all the feet resting firmly on the ground?	<ul style="list-style-type: none"> • Wash load may be unevenly distributed in drum. Stop washing machine and rearrange wash load.
Water leaks	Inlet hoses or drain hose are loose at tap or washing machine.	<ul style="list-style-type: none"> • Check and tighten hose connections.
	House drain pipes are clogged.	<ul style="list-style-type: none"> • Unclog drain pipe. Contact plumber if necessary.
Oversudsing		<ul style="list-style-type: none"> • Too much detergent or unsuitable detergent may cause excessive foaming which may result in water leaks.
Water does not enter washing machine or it enters slowly	Water supply is not adequate in that location.	<ul style="list-style-type: none"> • Check another tap in the house.
	Water supply tap is not completely open.	<ul style="list-style-type: none"> • Fully open tap.
	Water inlet hose(s) are kinked.	<ul style="list-style-type: none"> • Straighten hose.
	The filter of the inlet hose(s) clogged.	<ul style="list-style-type: none"> • Check the filter of the inlet hose.
Water in the washing machine does not drain or drains slowly	Drain hose is kinked or clogged.	<ul style="list-style-type: none"> • Clean and straighten the drain hose.
	The drain filter is clogged.	<ul style="list-style-type: none"> • Clean the drain filter.

Symptoms	Reason	Solution
Washing machine does not start	Electrical power cord may not be plugged in or connection may be loose.	<ul style="list-style-type: none"> • Make sure plug fits tightly in wall outlet.
	House fuse blown, circuit breaker tripped, or a power outage has occurred.	<ul style="list-style-type: none"> • Reset circuit breaker or replace fuse. Do not increase fuse capacity. If problem is a circuit overload, have it corrected by a qualified electrician.
	Water supply tap is not turned on.	<ul style="list-style-type: none"> • Turn on water supply tap.
Washing machine will not spin	Check that the door is firmly shut.	<ul style="list-style-type: none"> • Close the door and press the Start/Pause button. After pressing the Start/Pause button, it may take a few moments before the washing machine begins to spin. The door must be locked before spin can be achieved. Add 1 or 2 similar items to help balance the load. Rearrange load to allow proper spinning.
Door does not open		<ul style="list-style-type: none"> • Once washing machine has started, the door cannot be opened for safety reasons. Check if the 'Door Lock' icon is illuminated. You can safely open the door after the 'Door Lock' icon turns off.
Wash cycle time delayed		<ul style="list-style-type: none"> • The washing time may vary by the amount of laundry, water pressure, water temperature and other usage conditions. If an imbalance is detected or if the suds removing programme is on, the wash time will increase.
Fabric softener overflow	Too much softener may cause an overflow.	<ul style="list-style-type: none"> • Follow softener guidelines to ensure appropriate amount is used. Do not exceed the maximum fill line.
Softeners dispensed too early		<ul style="list-style-type: none"> • Close the dispenser drawer slowly. Do not open the drawer during the wash cycle.
Dry problem	Does not dry	<ul style="list-style-type: none"> • Do not overload. Check that the washing machine is draining properly to extract adequate water from the load. Clothes load is too small to tumble properly. Add a few towels.

Error Messages

Symptoms	Reason	Solution
 	<p>Water supply is not adequate in area.</p> <p>Water supply taps are not completely open.</p> <p>Water inlet hose(s) are kinked.</p> <p>The filter of the inlet hose(s) are clogged.</p> <p>If water leakage occurred in the inlet hose, indicator (A) will become red.</p>  <ul style="list-style-type: none"> • May vary depending on the model. 	<ul style="list-style-type: none"> • Check another tap in the house. • Fully open tap. • Straighten hose(s). • Check the filter of the inlet hose.
 	<p>Drain hose is kinked or clogged.</p> <p>The drain filter is clogged.</p>	<ul style="list-style-type: none"> • Clean and straighten the drain hose. • Clean the drain filter.
 	<p>Load is too small.</p> <p>Load is out of balance.</p> <p>The appliance has an imbalance detection and correction system. If individual heavy articles are loaded (e.g. bath mat, bath robe, etc.) this system may stop spinning or even interrupt the spin cycle altogether.</p> <p>If the laundry is still too wet at the end of the cycle, add smaller articles of laundry to balance the load and repeat the spin cycle.</p>	<ul style="list-style-type: none"> • Add 1 or 2 similar items to help balance the load. • Add 1 or 2 similar items to help balance the load. • Rearrange load to allow proper spinning. • Rearrange load to allow proper spinning.

Symptoms		Reason	Solution
	  	Ensure door is not open.	<ul style="list-style-type: none"> • Close the door completely. • If 'dE, dE 1, dE2' is not released, call for service.
			<ul style="list-style-type: none"> • Unplug the power plug and call for service.
		Water overfills due to the faulty water valve.	<ul style="list-style-type: none"> • Close the water tap. • Unplug the power plug. • Call for service.
		Water level sensor has malfunctioned.	<ul style="list-style-type: none"> • Close the water tap. • Unplug the power plug. • Call for service.
		Over load in motor.	<ul style="list-style-type: none"> • Allow the washing machine to stand for 30 minutes to allow the motor to cool, then restart the cycle.
		Water leaks.	<ul style="list-style-type: none"> • Call for service.
		Check water supply.	<ul style="list-style-type: none"> • Turn the tap on. If 'dHE' is not released, unplug power plug and call for service.

WARRANTY

This limited warranty does not cover:

- Service trips to deliver, pick up, or install or repair the product; instruction to the customer on operation of the product; repair or replacement of fuses or correction of wiring or plumbing, or correction of unauthorized repairs/ installation.
- Failure of the product to perform during power failures and interruptions or inadequate electrical service.
- Damage caused by leaky or broken water pipes, frozen water pipes, restricted drain lines, inadequate or interrupted water supply or inadequate supply of air.
- Damage resulting from operating the Product in a corrosive atmosphere or contrary to the instructions outlined in the Product's owner's manual.
- Damage to the Product caused by accidents, pests and vermin, lightning, wind, fire, floods, or acts of God.
- Damage or failure caused by unauthorized modification or alteration, or if it is used for other than the intended purpose, or any water leakage where the product was not properly installed.
- Damage or failure caused by incorrect electrical current, voltage, or plumbing codes, commercial or industrial use, or use of accessories, components, or consumable cleaning products that are not approved by LG.
- Damage caused by transportation and handling, including scratches, dents, chips, and/or other damage to the finish of your product, unless such damage results from defects in materials or workmanship.
- Damage or missing items to any display, open box, discounted, or refurbished Product.
- Products with original serial numbers that have been removed, altered, or cannot be readily determined. Model and Serial numbers, along with original retail sales receipt, are required for warranty validation.
- Increases in utility costs and additional utility expenses.
- Repairs when your Product is used in other than normal and usual household use or contrary to the instructions outlined in the Product's owner's manual.
- Costs associated with removal of your Product from your home for repairs.
- The removal and reinstallation of the Product if it is installed in an inaccessible location or is not installed in accordance with published installation instructions, including LG's owner's and installation manuals.
- Damage resulting from misuse, abuse, improper installation, repair, or maintenance. Improper repair includes use of parts not approved or specified by LG.

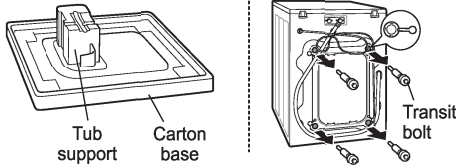
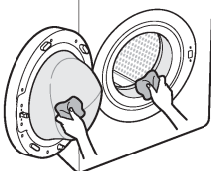
<p>Strange vibration or noise caused by not removing transit bolts or tub support.</p>		<p>Remove the transit bolts & tub support.</p>
<p>Leakage caused by dirt (hair, lint) on gasket and door glass.</p>		<p>Clean the gasket & door glass.</p>

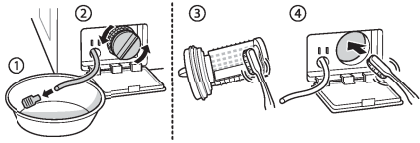
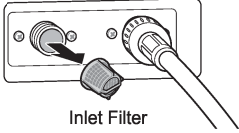
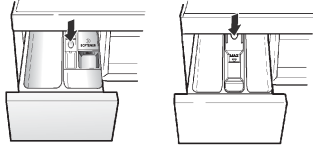
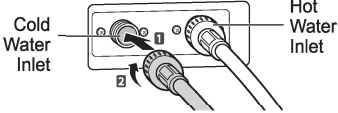
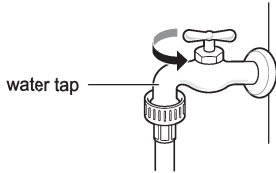
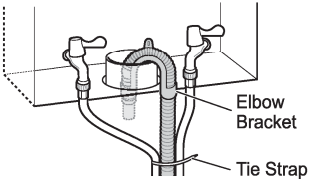
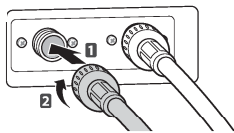
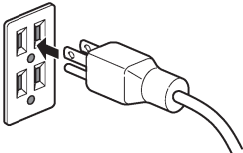
<p>Not draining caused by clogging of pump filter.</p>	<p>➔</p>		<p>Clean the pump filter.</p>
<p>Water is not coming because water inlet valve filters are clogged or water inlet hoses are kinked.</p>	<p>➔</p>	 <p>Inlet Filter</p>	<p>Clean the inlet valve filter or reinstall the water inlet hoses.</p>
<p>Water is not coming because too much detergent use.</p>	<p>➔</p>	 <p>Dispenser</p>	<p>Clean the detergent dispenser drawer.</p>
<p>Laundry is hot or warm after finished washing because the inlet hoses are installed in reverse.</p>	<p>➔</p>	 <p>Cold Water Inlet</p> <p>Hot Water Inlet</p>	<p>Reinstall the inlet hoses.</p>
<p>Water is not supplied because the water tap is not turned on.</p>	<p>➔</p>	 <p>water tap</p>	<p>Turn on the water tap.</p>
<p>Leakage caused by improper installation of drain hose or clogged drain hose.</p>	<p>➔</p>	 <p>Elbow Bracket</p> <p>Tie Strap</p>	<p>Reinstall the drain hose.</p>
<p>Leakage caused by improper installation of water inlet hose or using other brand inlet hoses.</p>	<p>➔</p>		<p>Reinstall the inlet hose.</p>
<p>No power problem caused by loose connection of power cord or electrical outlet problem.</p>	<p>➔</p>		<p>Reconnect the power cord or change the electrical outlet.</p>

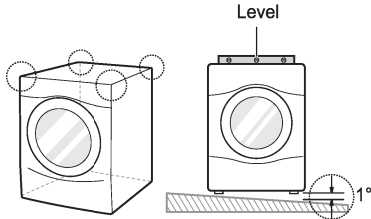
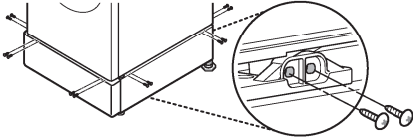
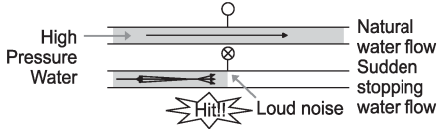
<p>Service trips to deliver, pick up, install the product or for instruction on product use. The removal and reinstallation of the Product.</p>	<p>➔</p>		<p>The warranty covers manufacturing defects only. Service resulting from improper Installation is not covered.</p>
<p>If all screws are not installed properly, it may cause excessive vibration (Pedestal model only).</p>	<p>➔</p>		<p>Install 4 screws at each corner (Total 16EA).</p>
<p>Water hammering (banging) noise when washing machine is filling with water.</p>	<p>➔</p>		<p>Adjust the water pressure by turning down the water valve or water tap in the home.</p>

OPERATING DATA

Product fiche_Commission Directive 96/60/EC		
Supplier's trade mark	LG	
Supplier's model identifier	FH4U2TDH(0-9)N	
The energy efficiency class of the model is determined in accordance with Annex IV. Expressed as 'Energy efficiency class... on a scale of A (more efficient) to G (less efficient)'. Where this information is provided in a table this may be expressed by other means providing it is clear that the scale is from A (more efficient) to G (less efficient).	A	
Where the information is provided in a table, and where some of the appliances listed in the table have been granted a 'Community Eco-label' pursuant to Regulation (EEC) No 880/92, this information may be included here. In this case the row heading shall state 'Community Eco-label', and the entry shall consist of a copy of the Eco-label mark. This provision is without prejudice to any requirements under the EU Eco-label scheme.	No	
Energy consumption for washing, spinning, and drying, in kWh per complete operating cycle as defined in Annex I note V.	5.44	kWh / cycle
Energy consumption for washing and spinning only, in kWh per washing cycle as defined in Annex I note VI.	1.52	kWh / cycle
Washing performance class determined in accordance with Annex IV. Expressed as 'Washing performance class ... on a scale of A (higher) to G (lower)'. This may be expressed by other means provided it is clear that the scale is from A (higher) to G (lower).	A	
Water extraction efficiency for a standard 60 °C cotton washing cycle, determined in accordance with the test procedures of the harmonised standards referred to in Article 1 (2). Expressed as 'Water remaining after spin ... % (as proportion of dry weight of the wash)'. Maximum spin speed attained as defined in Annex I note VIII.	44	%
Washing capacity of appliance for a standard 60 °C cotton washing cycle, as defined in Annex I note IX.	1400	rpm
Drying capacity of appliance for a standard 'dry cotton' drying cycle, as defined in Annex I note X.	8	kg
Water consumption for washing, spinning and drying, in litres per complete operating cycle as defined in Annex I note XI.	5	kg
Water consumption for washing and spinning only, in litres, per standard 60 °C cotton washing (and spinning) cycle determined in accordance with the test procedures of the harmonized standards referred to in Article 1 (2).	89	litres / cycle
Washing and drying time. Programme time for complete operating cycle (60 °C cotton washing and 'dry cotton' drying). For rated washing capacity, determined in accordance with the test procedures of the harmonised standards referred to in Article 1 (2).	65	litres / cycle
The consumption of energy and water equal to 200 times the consumption expressed in points 5 (energy) and 12 (water). This shall be expressed as 'estimated annual consumption for a four-person household, always using the drier (200 cycles)'. The consumption of energy and water equal to 200 times the consumption expressed in points 6 (energy) and 13 (water). This shall be expressed as 'estimated annual consumption for a four-person household, never using the drier (200 cycles)'.	735	min.
The consumption of energy and water equal to 200 times the consumption expressed in points 5 (energy) and 12 (water). This shall be expressed as 'estimated annual consumption for a four-person household, always using the drier (200 cycles)'.	1088	kWh / year
	17800	litres / year
The consumption of energy and water equal to 200 times the consumption expressed in points 6 (energy) and 13 (water). This shall be expressed as 'estimated annual consumption for a four-person household, never using the drier (200 cycles)'.	304	kWh / year
	13000	litres / year

Memo

Memo

Memo

