

3D Blu-ray™ / DVD Home Theatre System

BH6540TW

ENGLISH | SIMPLE MANUAL

An extended Owner's Manual that contains information on the advanced features is located on the CD-ROM provided in an electronic version. To read these files, you will need to use a Personal Computer (PC) equipped with a CD-ROM drive.

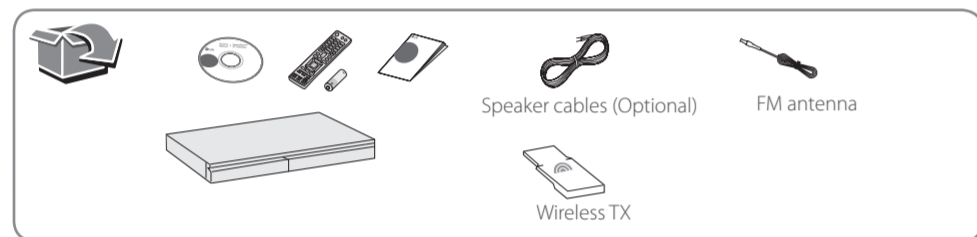

www.lg.com

TV Connection (HDMI OUT)

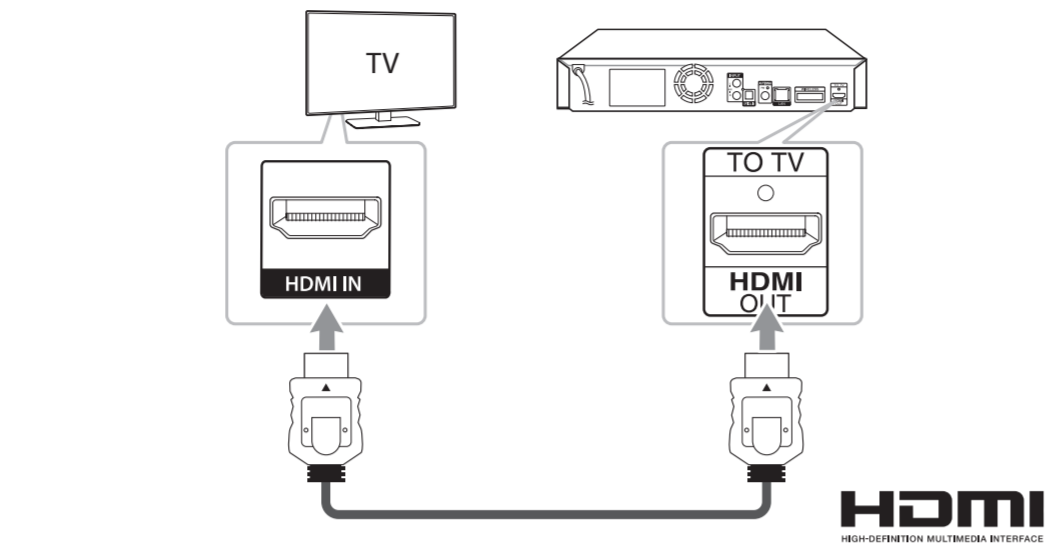

OPTICAL IN Connection

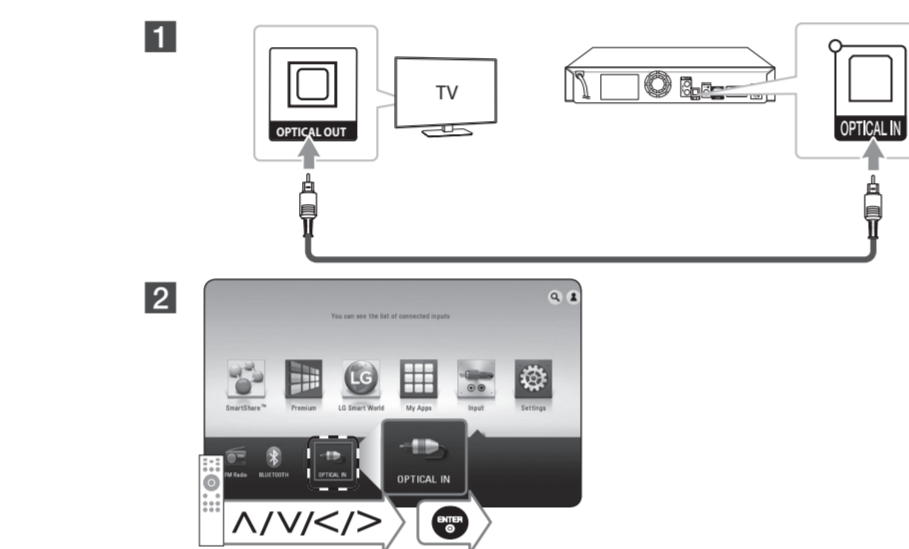

Wired Network Connection

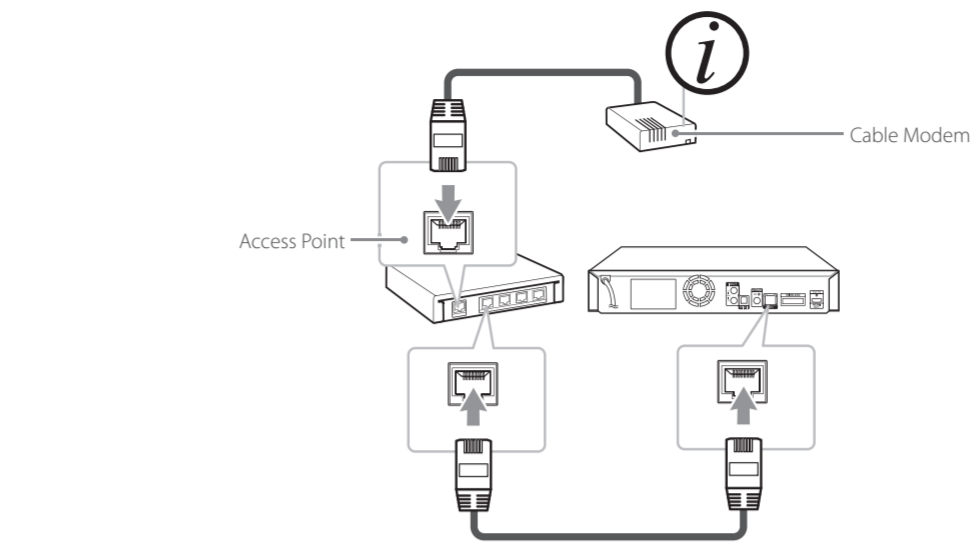

Speaker Connection

1 Speaker design and connection method may be different according to models

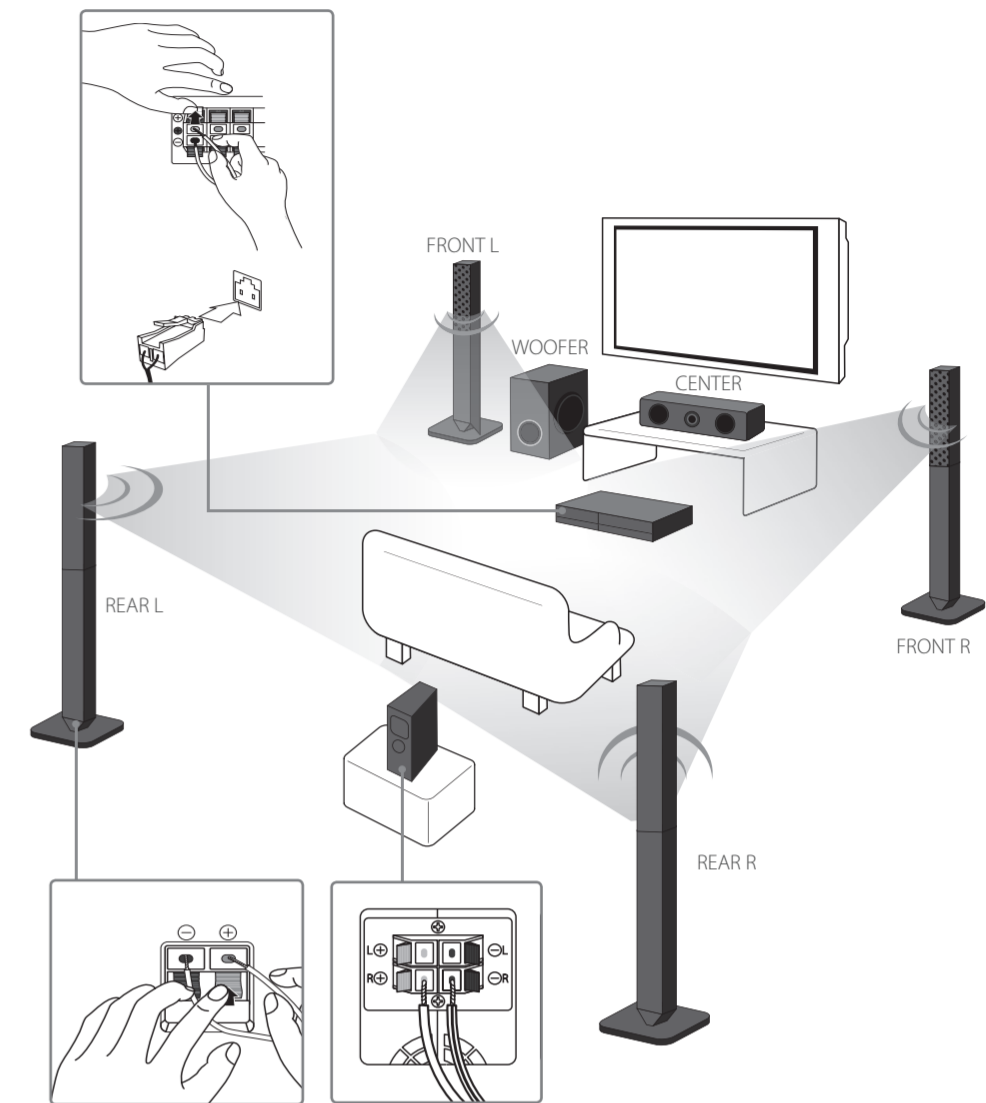

Initial Setup

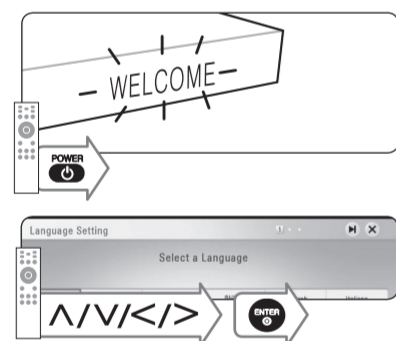

Follow the directions for the initial setup displayed on the screen.

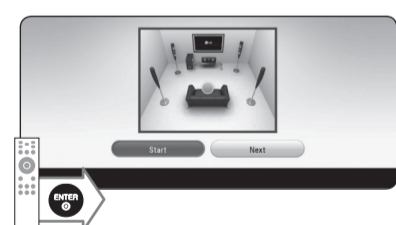

Start the speaker test.



Stop the speaker test and select [Next].

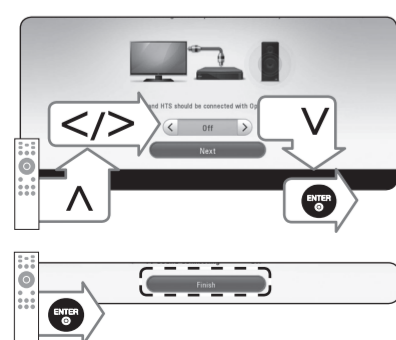

Setup [TV Sound Connecting] and select [Next].

Using HOME menu

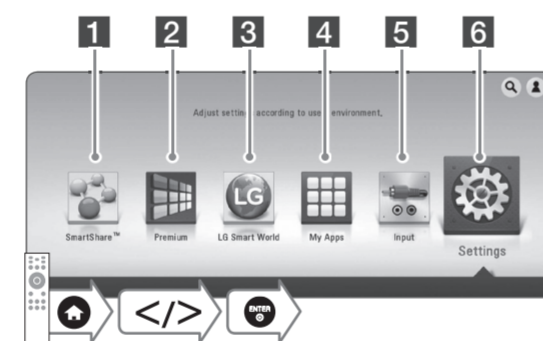

- 1 Displays SmartShare menu.
- 2 Displays the Premium Home screen.
- 3 Displays LG Apps titles provided to the unit.
- 4 Displays the [My Apps] screen.
- 5 Changes input mode.
- 6 Adjusts the system settings.

Disc, Data Playback

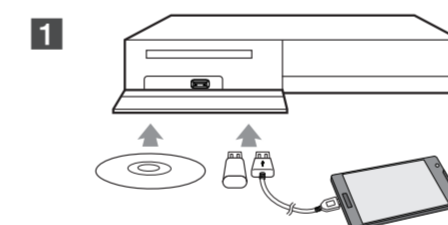

1 Devices that support MTP.

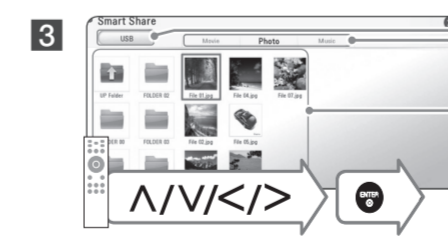
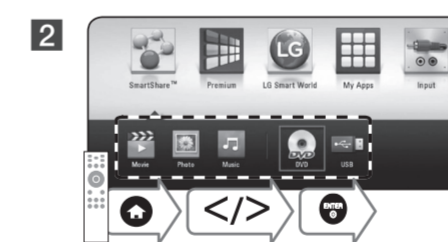

Displays all linked devices.

Selects video, photo or audio content.

Displays the file or folder on linked device.

1 For the most Audio CD, BD-ROM and DVD-ROM discs, playback starts automatically.

Network Playback

SmartShare PC software Installation

- 1 Install SmartShare PC Software.

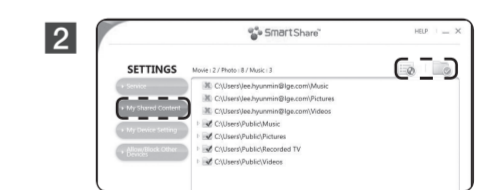

Run the program, and set the share folder you want.

SmartShare Network Playback

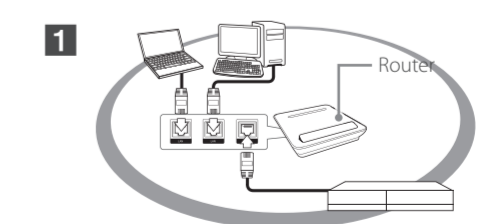

Check the network connection and settings.

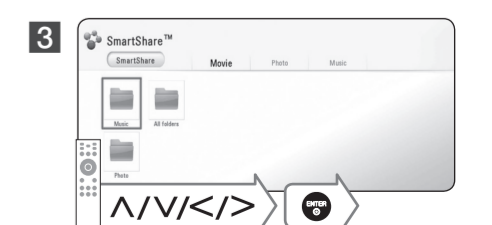
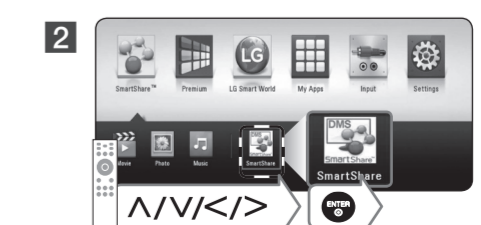



Enjoying Private Sound

- 1 Router
Make sure that your smartphone is connected to the same Wi-Fi network as this player.
- 2 Turn on the mobile device LG AV Remote app is installed and run LG AV Remote.
- 3 Remote Control
 Run LG AV Remote.

Not all modes support private sound and pairing multiple devices is not available.



Software Update

- 1 Settings
- 2 Software Update
- 3 Updating
- 4 Update Complete



Additional Information

Customer Support

You can update the Player using the latest software to enhance the products operation and/or add new features. To obtain the latest software for this player (if updates have been made), proceed the software updates as above or visit <http://www.lg.com> or contact LG Electronics customer care centre.

Open source software notice

To obtain the corresponding source code under GPL, LGPL and other open source licenses, please visit <http://opensource.lge.com>. All referred license terms, warranty disclaimers and copyright notices are available to download with the source code.



Specification

ENGLISH

Power requirements	Refer to main label
Power consumption	Refer to main label
Dimensions (W x H x D)	Approx. 360 mm x 60.5 mm x 299 mm
Net Weight (Approx.)	2.7 kg
Bus Power Supply (USB)	5 V --- 500 mA

Design and specifications are subject to change without notice.

Safety Information

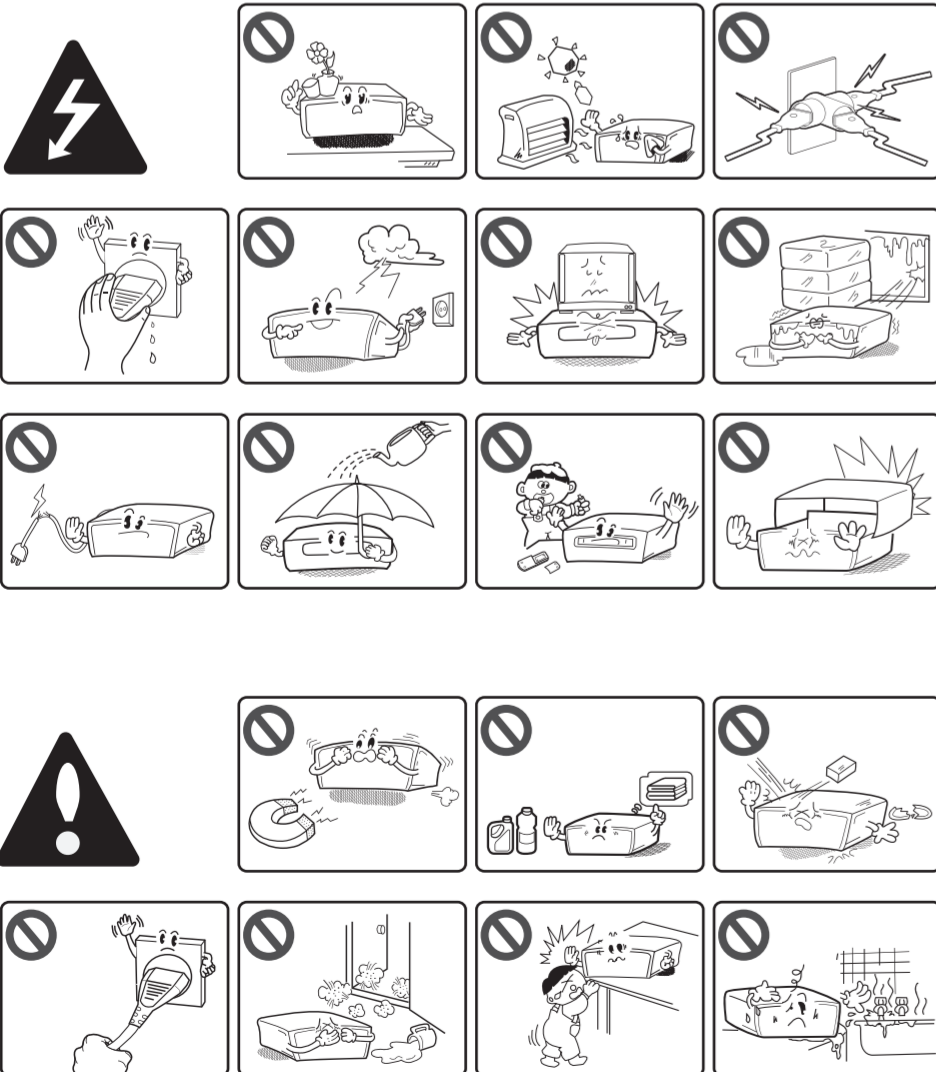

CAUTION
RISK OF ELECTRIC SHOCK
DO NOT OPEN

CAUTION: TO REDUCE THE RISK OF ELECTRIC SHOCK DO NOT REMOVE COVER (OR BACK) NO USER-SERVICEABLE PARTS INSIDE. REFER SERVICING TO QUALIFIED SERVICE PERSONNEL.

This lightning flash with arrowhead symbol within an equilateral triangle is intended to alert the user to the presence of uninsulated dangerous voltage within the product's enclosure that may be of sufficient magnitude to constitute a risk of electric shock to persons.

The exclamation point within an equilateral triangle is intended to alert the user to the presence of important operating and maintenance (servicing) instructions in the literature accompanying the product.

WARNING: TO PREVENT FIRE OR ELECTRIC SHOCK HAZARD, DO NOT EXPOSE THIS PRODUCT TO RAIN OR MOISTURE.

WARNING: Do not install this equipment in a confined space such as a book case or similar unit.

CAUTION: Do not block any ventilation openings. Install in accordance with the manufacturer's instructions. Slots and openings in the cabinet are provided for ventilation and to ensure reliable operation of the product and to protect it from overheating. The openings shall be never be blocked by placing the product on a bed, sofa, rug or other similar surface. This product shall not be placed in a built-in installation such as a bookcase or rack unless proper ventilation is provided or the manufacturer's instruction has been adhered to.

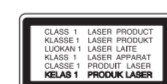

CAUTION: This product employs a Laser System. To ensure proper use of this product, please read this owner's manual carefully and retain it for future reference. Shall the unit require maintenance, contact an authorized service centre. Use of controls, adjustments or the performance of procedures other than those specified herein may result in hazardous radiation exposure. To prevent direct exposure to laser beam, do not try to open the enclosure.

CAUTION concerning the Power Cord
To disconnect power from the mains, pull out the mains cord plug. When installing the product, ensure that the plug is easily accessible.

CAUTION: The apparatus shall not be exposed to water (dripping or splashing) and no objects filled with liquids, such as vases, shall be placed on the apparatus.

This device is equipped with a portable battery or accumulator.
Safety way to remove the battery or the battery from the equipment: Remove the old battery or battery pack, follow the steps in reverse order than the assembly. To prevent contamination of the environment and bring on possible threat to human and animal health, the old battery or the battery put it in the appropriate container at designated collection points. Do not dispose of batteries or battery together with other waste. It is recommended that you use local, free reimbursement systems batteries and accumulators. The battery shall not be exposed to excessive heat such as sunshine, fire or the like.

- The appliance is not intended for use by young children or infirm persons without supervision.
- Young Children should be supervised to ensure that they do not play with appliance.
- If the appliance is supplied from a cord extension set or an electrical portable outlet device, the cord extension set on electrical portable outlet device must be positioned so that it is not subject to splashing or ingress of moisture.

RF Radiation Exposure Statement
This equipment should be installed and operated with minimum distance 20 cm between the radiator and your body.



Some of the content in this manual may differ from your player depending on the software of the player or your service provider.



Memo



Memo
