

* Image shown may differ from your TV.
* Image shown on a PC or mobile phone may vary depending on the OS(Operating System).

Wireless Network Connection

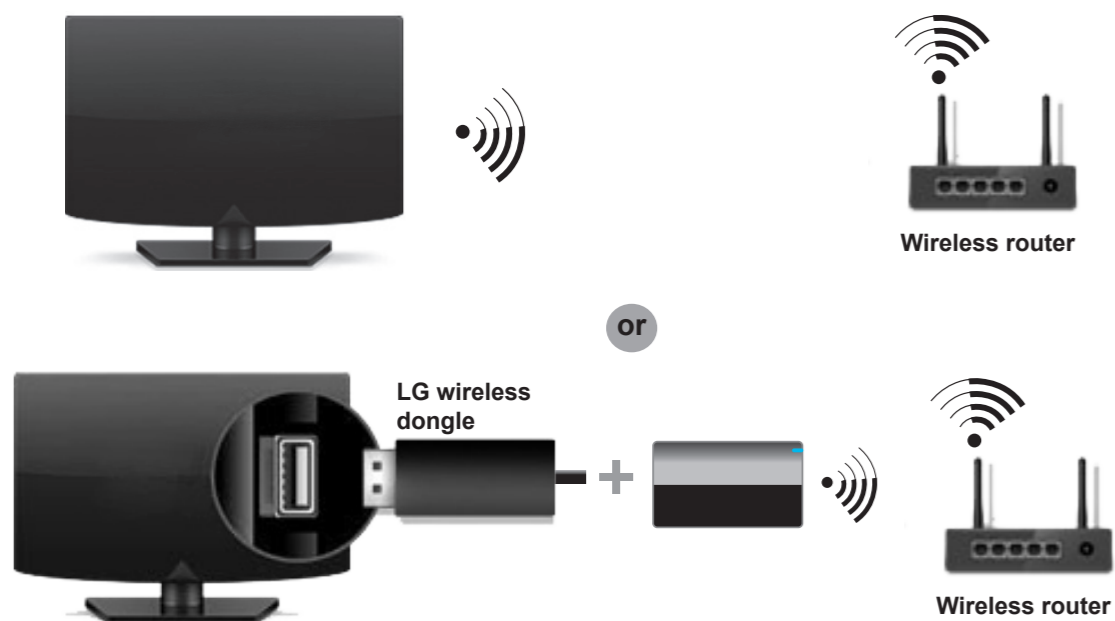

- NOTE**
- LG wireless dongle is required to use Wi-Fi network.
 - Do not remove the wireless dongle while the wireless network is working.

Wired Network Connection

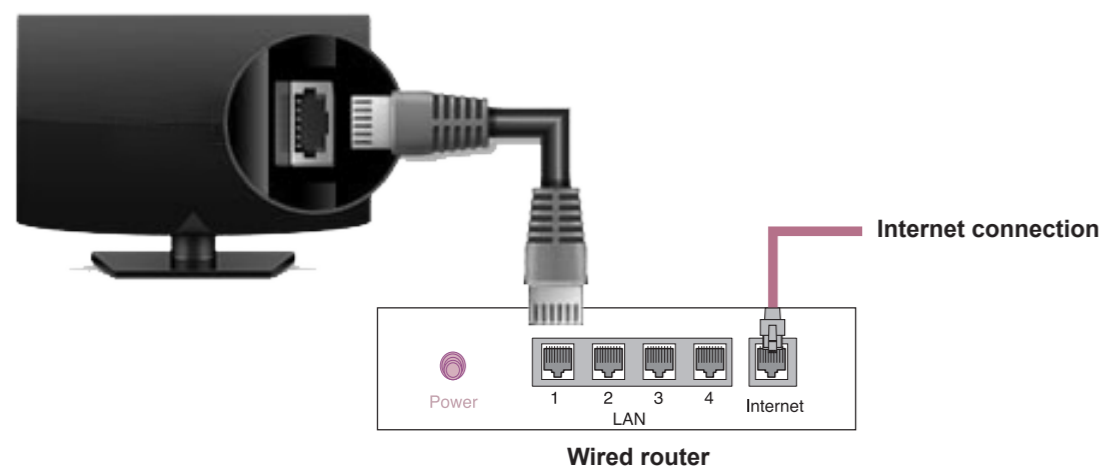

Network Setting

Premium Apps are pre-installed on the TV. These may vary by country.

- 1 Press the **Home** button to access the Home menu. Select **SETTINGS** and press **Wheel(OK)**.

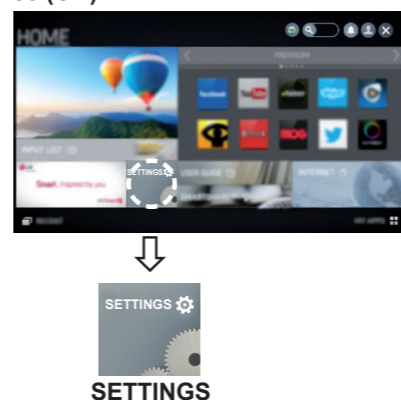

- 2 Select the **NETWORK** → **Network Connection** menu.

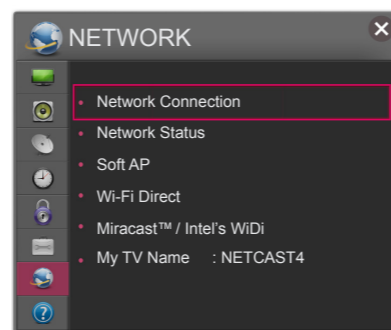

- 3 Select the **Start Connection**.

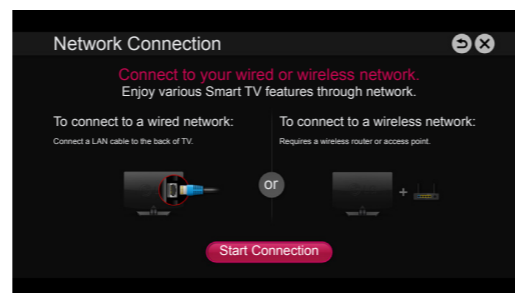

- 4 The device automatically tries to connect to the network available(wired network first).

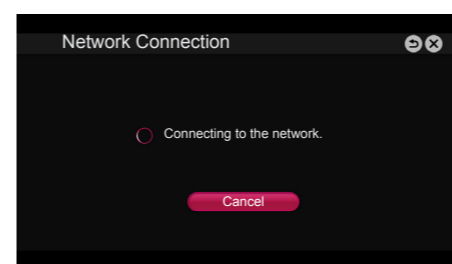

If you select **Cancel** or it fails to connect to the network, the network list available is displayed. Choose the network you want.

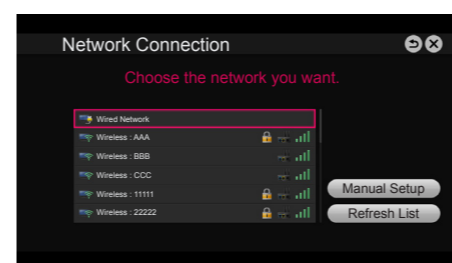

If you want to connect your TV to a wireless router, select the network you want and enter the password.

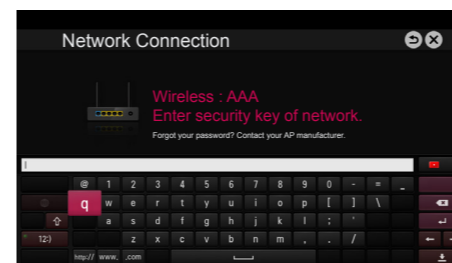

- 5 The connected network is displayed. Select **Complete** to confirm the network connection. If you select the **Other Network List**, the network list available is displayed.

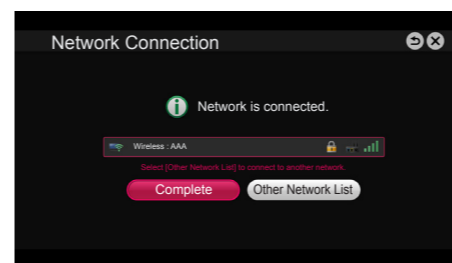

Troubleshooting Network Problems

- 1 Press the **Home** button to access the Home menu. Select **SETTINGS** and press **Wheel(OK)**.

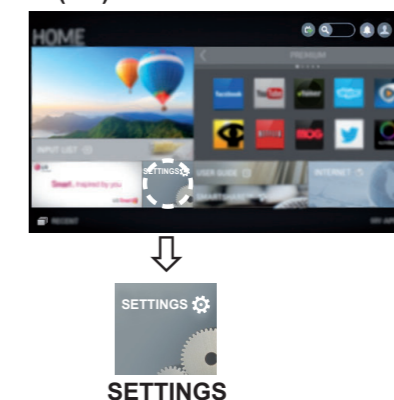

- 2 Select the **NETWORK** → **Network Status** menu.

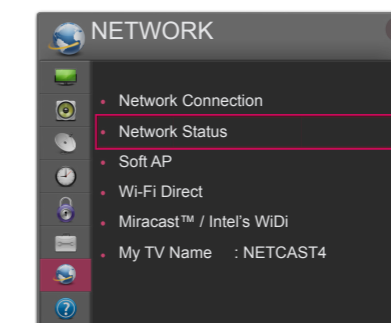

Follow the instructions below that correlate to your network status.

Check the TV or the router.

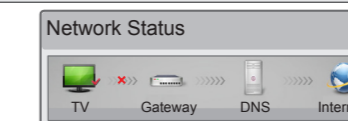

When an **✓** appears **TV**.

- 1 Check the connection status of TV, AP and cable modem.
- 2 Power off and power on TV, AP and cable modem.
- 3 If you are using a static IP, enter IP directly.
- 4 Contact internet companies or AP companies.
 - Additional points to check when using a wireless connection
 - 1 Check the password for the wireless connection in the router settings window.
 - 2 Change the router SSID (network name) or the wireless channel.

Check the router or consult your Internet service provider.

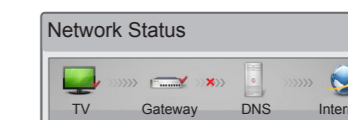

When an **✓** appears **TV and Gateway**.

- 1 Unplug the power cord of the AP, cable modem and try to connect after 5 seconds.
- 2 Initialize(Reset) the AP or cable modem.
- 3 Contact internet companies or AP companies.

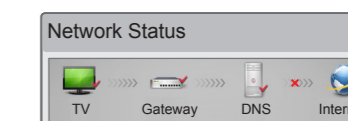

When an **✓** appears **TV, Gateway and DNS**.

- 1 Unplug the power cord of the AP, cable modem and try to connect after 5 seconds.
- 2 Initialize(Reset) the AP or cable modem.
- 3 Check that the MAC address of the TV/router is registered with your Internet service provider. (The MAC address displayed on the right pane of the network status window should be registered with your Internet service provider.)
- 4 Check the router manufacturer's website to make sure your router has the latest firmware version installed.

SmartShare PC SW Installing & Setting

- 1 Install the SmartShare PC SW program on your PC.
- 2 Go to www.lg.com. Then, select your region.
- 3 Select **SUPPORT**. Then, search for your model.
- 4 Select **Drivers & Software** or **SOFTWARE UPDATE**. Then, select SmartShare PC SW.
- 5 You can run the program when installation is complete.

NOTE

- **SmartShare** service is only available if TV and other devices are connected via a single AP (Router).

SmartShare Connection to Smartphone

- 1 Check that Wi-Fi is enabled on your smartphone. To use **SmartShare**, both devices must be on the same local network.
- 2 Install/run the app for sharing content on your smartphone (It's called **SmartShare** on LG phones).
- 3 Enable your smartphone to share content files with other devices.
- 4 Open **SmartShare** application. **(Home) → SmartShare.**
- 5 Select the file type you want to play (movie, audio or photo).
- 6 Select a movie, music or photo file to play on the TV.
- 7 Play the media file to view and enjoy it on your TV.

Updating the TV Firmware

(Home) → SETTINGS → SUPPORT → Software Update

Uses **Software Update** to check and obtain the latest version. It is also possible to check manually for available updates.

Software Update	Set it to On . If an update is available, a prompt will appear to perform the update.
Automatic update mode	If an update is available, the update automatically starts without prompting.
Check Update Version	Checks the version installed and when an update is available, the download process can be performed manually.

NOTE

- When the update starts, the update progress window appears for a short time and disappears.
- The latest version can be obtained via digital broadcast signals or internet connections.
- Changing the programme while downloading the software via digital broadcast signal interrupts the download process. Returning to the initial programme allows downloading to resume.
- If software is not updated, certain functions may not work properly.

Wi-Fi Direct Setting

(Home) → SETTINGS → NETWORK → Wi-Fi Direct

The **Wi-Fi Direct** function supports wireless connection technology. With **SmartShare™**, you can share files or screens of devices connected to **Wi-Fi Direct**.

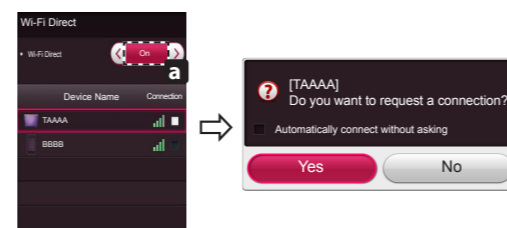

- 1 If **Wi-Fi Direct** is set to **On**, a list of available devices appears.
» To use **Wi-Fi Direct**, go to **SETTINGS → NETWORK** and set **Wi-Fi Direct (a)** to **On**.
- 2 When you are prompted to request connection, select **Yes**. **Wi-Fi Direct** is now connected to your TV.

* If you are not using **Wi-Fi Direct** to minimize the interference between Wi-Fi devices, it is recommended to set **Wi-Fi Direct (a)** to **Off**. You can only use devices that support **Wi-Fi Direct**.

Miracast Setting

Miracast allows a portable device to securely send video and sound to TV wirelessly.

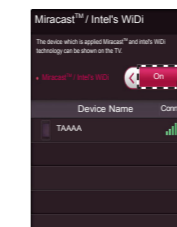

- 1 Miracast is set to **On (a)** on your TV and portable device. Go to the Network settings to set the Miracast.
- 2 When your portable device is detected, select the device.

WiDi (Wireless Display) Setting

WiDi represents Wireless Display. Intel's WiDi (Wireless Display) technology enables easy and fast connection without wires or internet network for mirrored and dual monitor display on your TV. You can sit back and experience your favorite movies, videos, photos, online shows and more in full HD on your TV with great image clarity and sound.

- 1 **Intel's WiDi** is set to **On**. Connect your laptop to AP. (Without AP, it is possible to this function; it is recommended to connect to AP.) Your laptop runs the Intel WiDi programme.
- 2 It detects LG Smart TVs available, which supports WiDi. In the list, select the TV you want and click Connect. Enter the PIN number (a) shown on the screen into the input field (b) on your laptop and then click Continue.

NOTE

- When you connect the TV and laptop, you should set up TV mode for "Live TV" and "external input". If not, your computer cannot detect LG Smart TV.

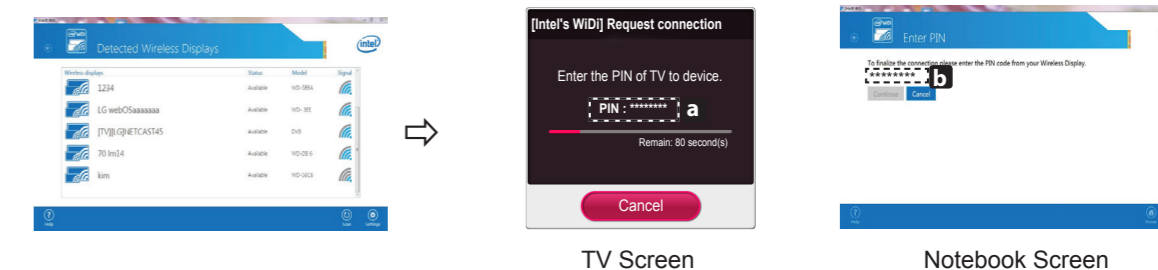

- 3 The wireless environment may affect the screen display. If the connection is poor, the Intel WiDi connection may be lost.

* LG TV is not need to register.

* For more information on Intel WiDi, visit <http://intel.com/go/widi>.

* A list of **Intel's WiDi** devices does not appear on the TV screen. Please check the list on your laptop.