

* Image shown may differ from your TV.

* Image shown on a PC or mobile phone may vary depending upon the Operating System (OS).

Wireless Network Connection

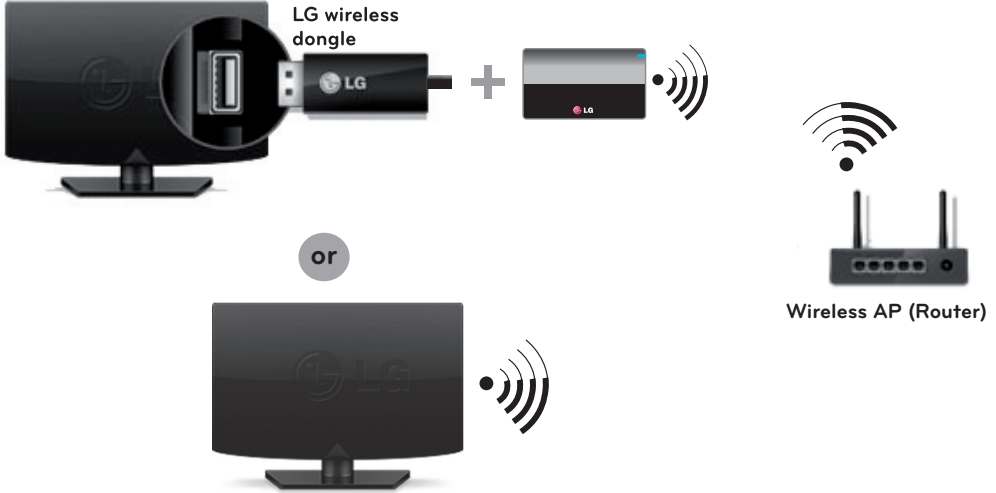

Wired Network Connection

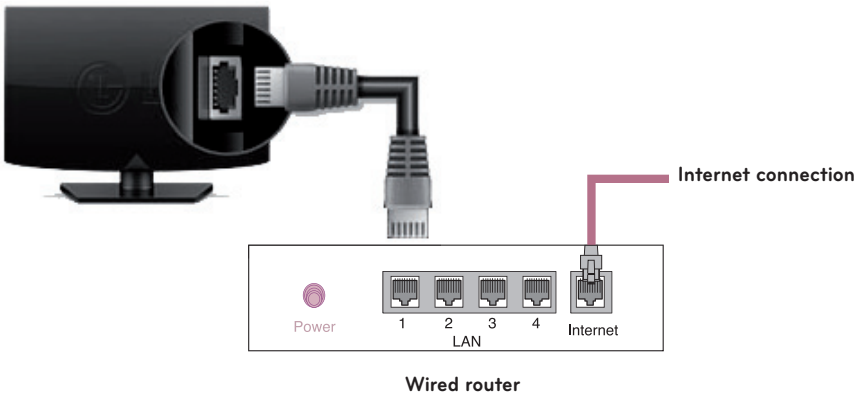

* M B M 6 4 1 0 1 9 0 2 *

Network Settings

Premium Apps are pre-installed on the TV. These may vary by country. Depending upon the version of the software, icon position can be changed.

- 1 Press the **Home** button to access the Home menu. Select **Settings** and press **Wheel (OK)**.

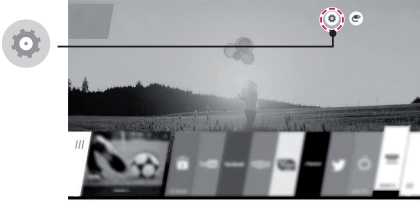

- 2 Select the **Network** **Wired Connection (Ethernet)** or **Wi-Fi Connection**.



- 3 The device automatically tries to connect to the network available (wired network first). When you select the **Wi-Fi Connection**, the network list available is displayed. Choose the network you wish to use.



- 4 If the connection is completed, **Connected to Internet** is displayed.



You can check the status of connection in **Advanced Settings**.



For wireless AP (Router) that have the **lock** symbol, you need to enter the security key.

Troubleshooting Network Problems

Depending upon the version of the software, icon position can be changed.

- 1 Press the **Home** button to access the Home menu. Select **Settings** and press **Wheel (OK)**.

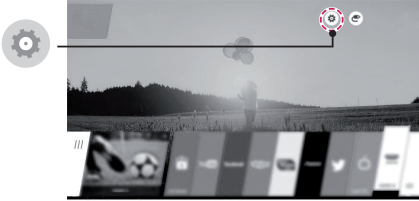

- 2 Select the **Network** **Wired Connection (Ethernet)** or **Wi-Fi Connection** **Advanced Settings**.

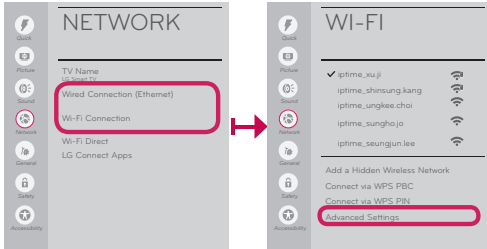

Follow the instructions below that correlate to your network status.

Check the TV or the AP (Router).



When X appears next to TV:

- 1 Check the connection status of the TV, AP (Router) and cable modem.
- 2 Power off and power on in the following order; (1st) the cable modem, wait for the cable modem to reset (2nd) the AP (Router), wait for the AP (Router) to reset and the (3rd) TV.
- 3 If you are using a static IP, enter the IP directly.
- 4 Contact internet service provider or AP (Router) companies.

Check the AP (Router) or consult your Internet service provider.



When X appears next to Gateway:

- 1 Unplug the power cord of the AP (Router), cable modem, wait 10 seconds. Reapply power.
- 2 Initialize (Reset) the AP (Router) or cable modem.
- 3 Contact internet service provider or AP (Router) companies.



When X appears next to DNS:

- 1 Unplug the power cord of the cable modem or the AP (Router), wait 10 seconds. Reapply power.
- 2 After the cable modem or AP (Router) has Initialized (Reset), try to reconnect.
- 3 Check that the MAC address of the TV/ AP (Router) is registered with your Internet service provider. (The MAC address displayed on the right pane of the network status window should be registered with your Internet service provider.)
- 4 Check the AP (Router) manufacturer's website to make sure your router has the latest firmware version installed.

SmartShare PC SW Installation & Setting

Install the **SmartShare PC SW** program on your PC.

- 1 Go to **www.lg.com**. Then, select your region.
- 2 Select **SUPPORT**. Then, search for your model.
- 3 Select **Drivers & Software** or **SOFTWARE UPDATE**. Then, select **SmartShare PC SW**.
- 4 Download the SmartShare PC SW and Install it on your PC. You can run the program when installation is complete.





NOTE

- **SmartShare** service is only available if TV and other devices are connected via a single AP (Router).

SmartShare Connection to Smartphone



- 1 Check that Wi-Fi is enabled on your smartphone. To use **SmartShare**, both devices must be on the same local network.
- 2 Install/run the app for sharing content on your smartphone (It's called **SmartShare** on LG phones).
- 3 Enable your smartphone to share content files with other devices.
- 4 Open **SmartShare** application on TV.  **(Home)**  **SmartShare**
- 5 Select the file type you want to play (movie, audio or photo).
- 6 Select a movie, music or photo file to play on the TV.
- 7 Play the media file to view and enjoy it on your TV.

Updating the TV Firmware

🏠 (Home) ▶ ⚙️ (Settings) ▶ 🏠 General ▶ ABOUT THIS TV ▶ CHECK FOR UPDATES

You can check the Software Version and update it.

If you check the **Allow Automatic Updates**, the TV will check for updated software automatically each time the set is turned on (Internet Connection is required).

* When the TV is turned on for the first time after a software update, initialization of the TV may take up to one minute.

ENGLISH

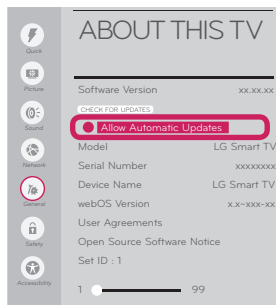
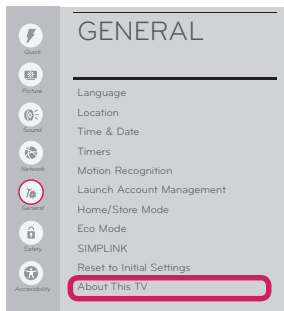

Wi-Fi Direct Setting

🏠 (Home) ▶ ⚙️ (Settings) ▶ 🌐 Network ▶ Wi-Fi DIRECT

If a local network is not available, you can connect a portable device directly to the TV using Wi-Fi Direct.

With **SmartShare**, you can share files or screens of devices connected to **Wi-Fi Direct**.

- 1 If **Wi-Fi Direct** is set to **On**, a list of available devices appears. Select your device.



- 2 When you are prompted to the connection request, select **Yes**. **Wi-Fi Direct** is now connected to your TV.

* If you are not using **Wi-Fi Direct** to minimize the interference between Wi-Fi devices, it is recommended to set **Wi-Fi Direct** to **Off**. You can only use devices that support Wi-Fi Direct.

Miracast Setting

Miracast allows a portable device to securely send video and sound to the TV wirelessly.



🏠 (Home) ▶ Screen Share

- 1 **Miracast** should be set to **ON** on your portable device.
- 2 When your TV is detected, select the device on your portable device.
When connection is completed, the TV screen appears on the device screen.

WiDi (Wireless Display) Setting

Intel's WiDi (Wireless Display) technology enables easy and fast connection without wires or internet network for mirrored and dual monitor display on your TV. You can sit back and experience your favorite movies, videos, photos, online shows and more in full HD on your TV with great image clarity and sound.

🏠 (Home) ▶ Screen Share

- 1 On the TV Intel's WiDi is set to **On**. Your laptop runs the Intel WiDi  program.
 - * LG TVs do not need to register.
 - * For more information on Intel WiDi, visit <http://intel.com/go/widi>.
 - * You can control your PC using the Magic Remote Control. (above WiDi version 4.2)
- 2 It detects LG Smart TVs available, which supports WiDi. In the list, select the TV you want and click Connect. Enter the number shown on the screen into the input field (a) on your laptop and then click Continue.

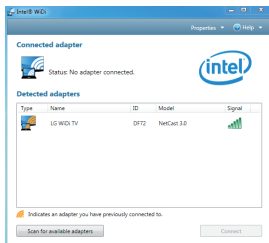

Notebook Screen

- 3 The laptop screen appears on the TV screen. The wireless environment may affect the screen display. If the connection is poor, the Intel WiDi connection may be lost.

