

**9.1 channel
Cinema Sound**
3D Blu-ray™ / DVD Home
Theatre System
BH9540TW

SIMPLE MANUAL

An extended Owner's Manual that contains information on the advanced features is located on the CD-ROM provided in an electronic version. To read these files, you will need to use a Personal Computer (PC) equipped with a CD-ROM drive.

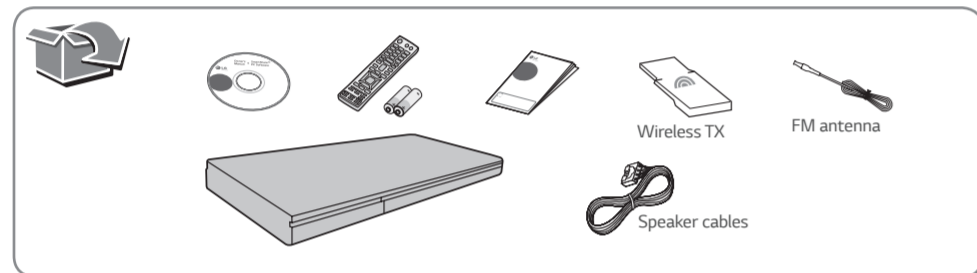

www.lg.com

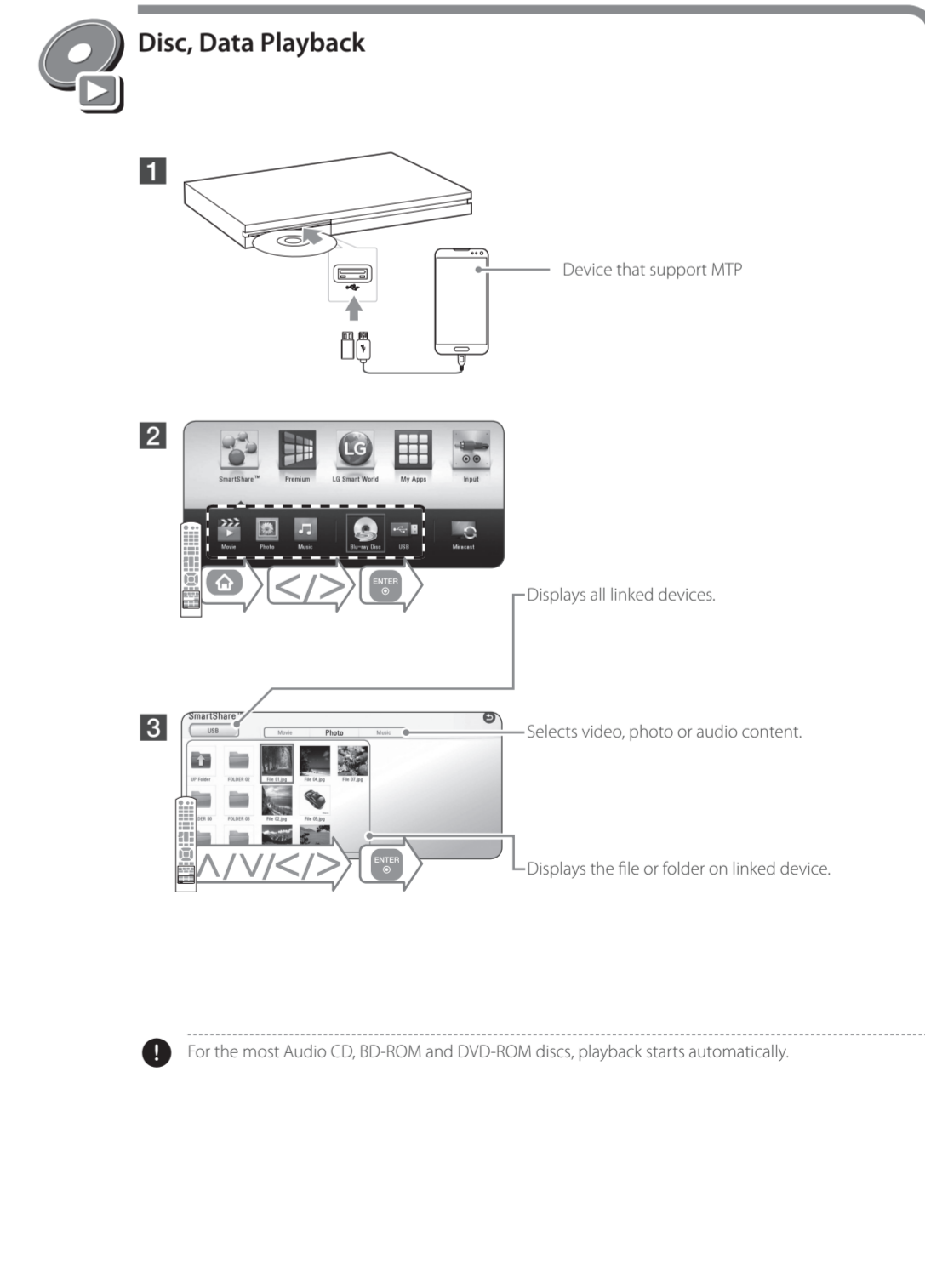
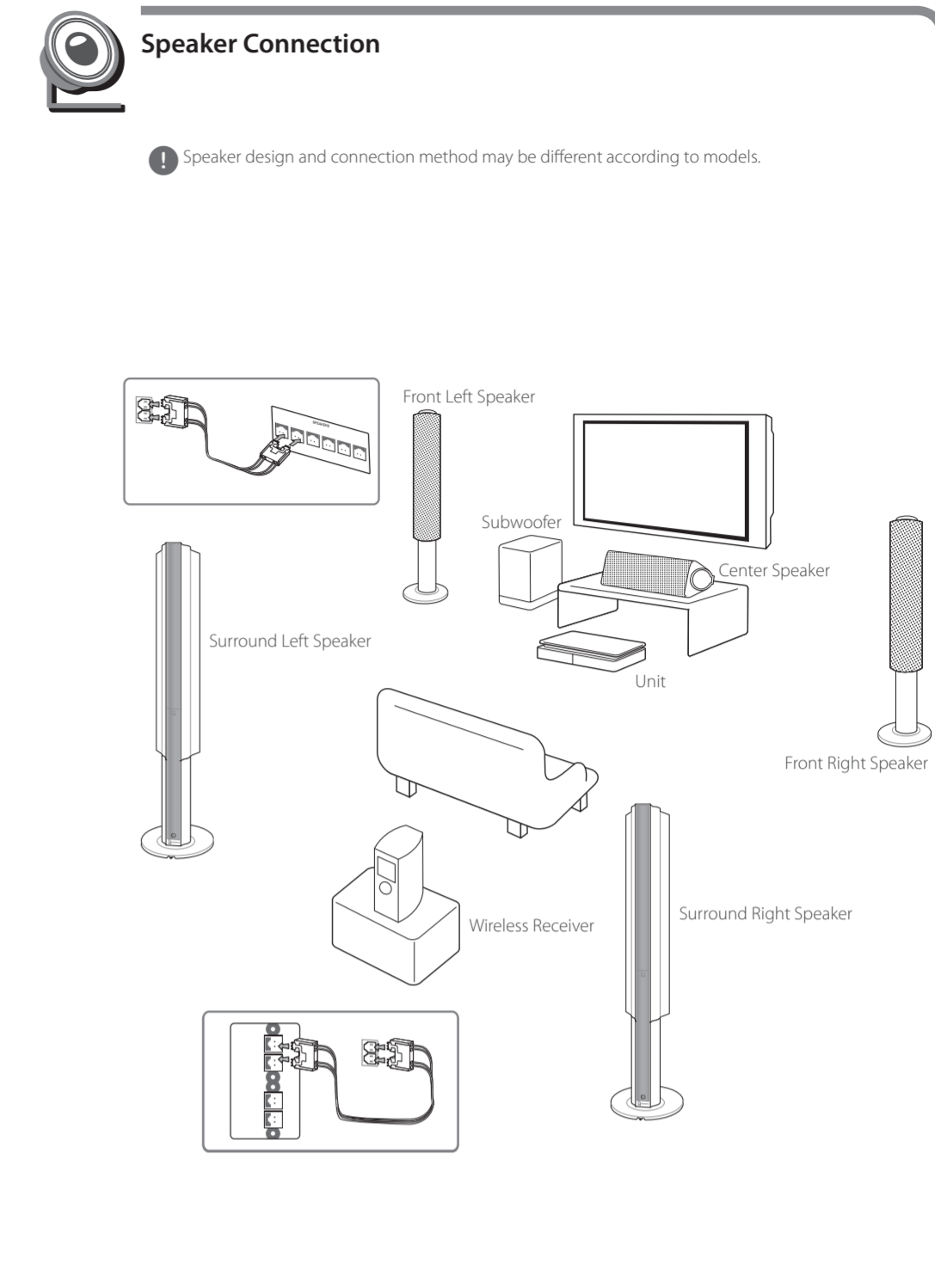
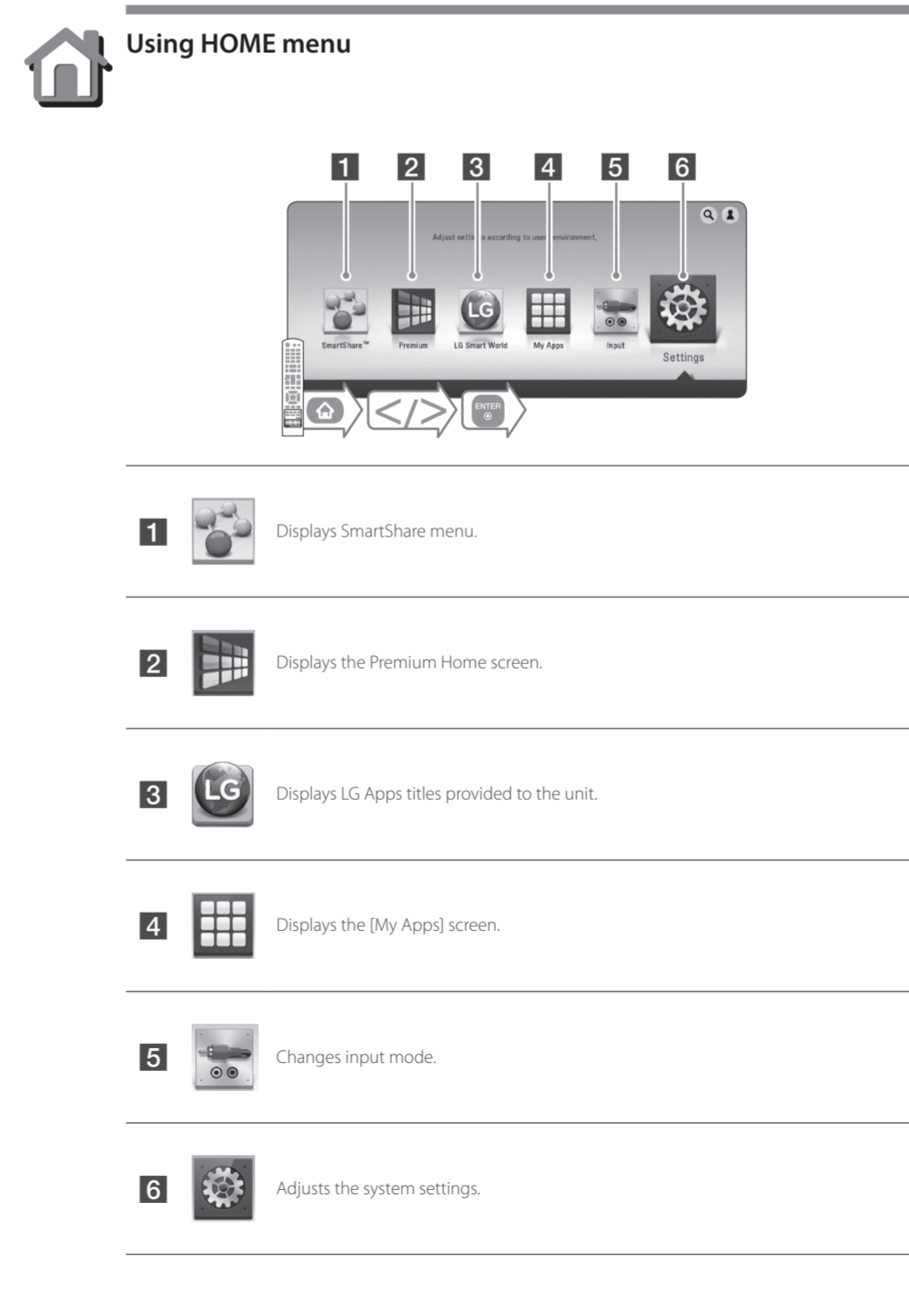
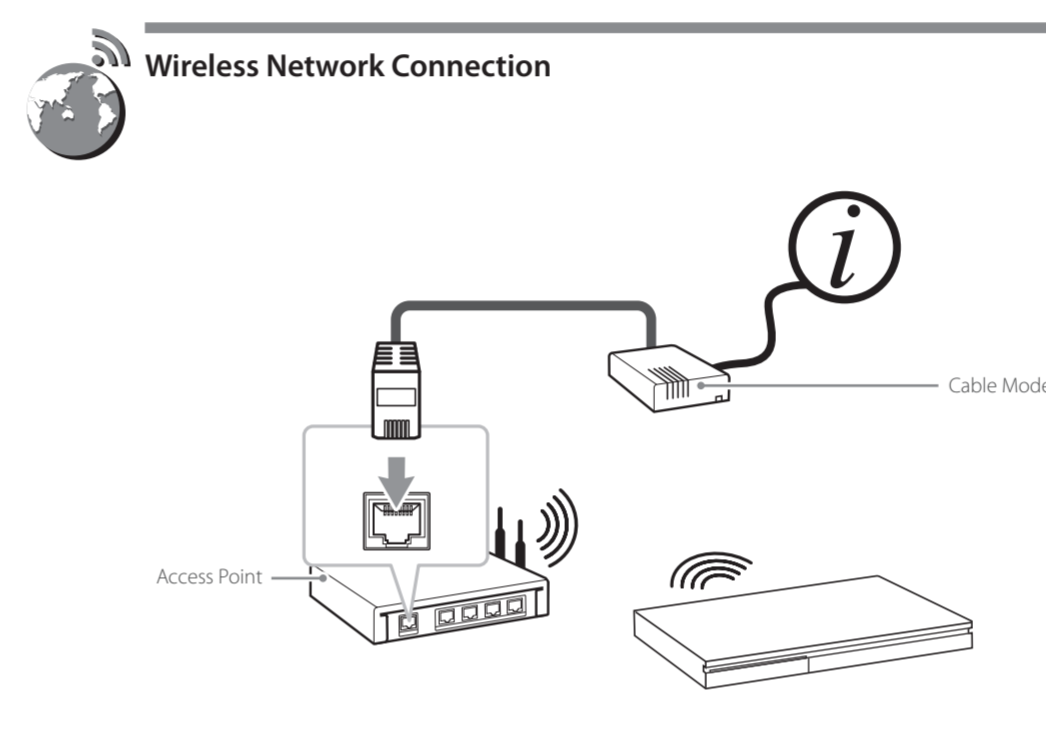
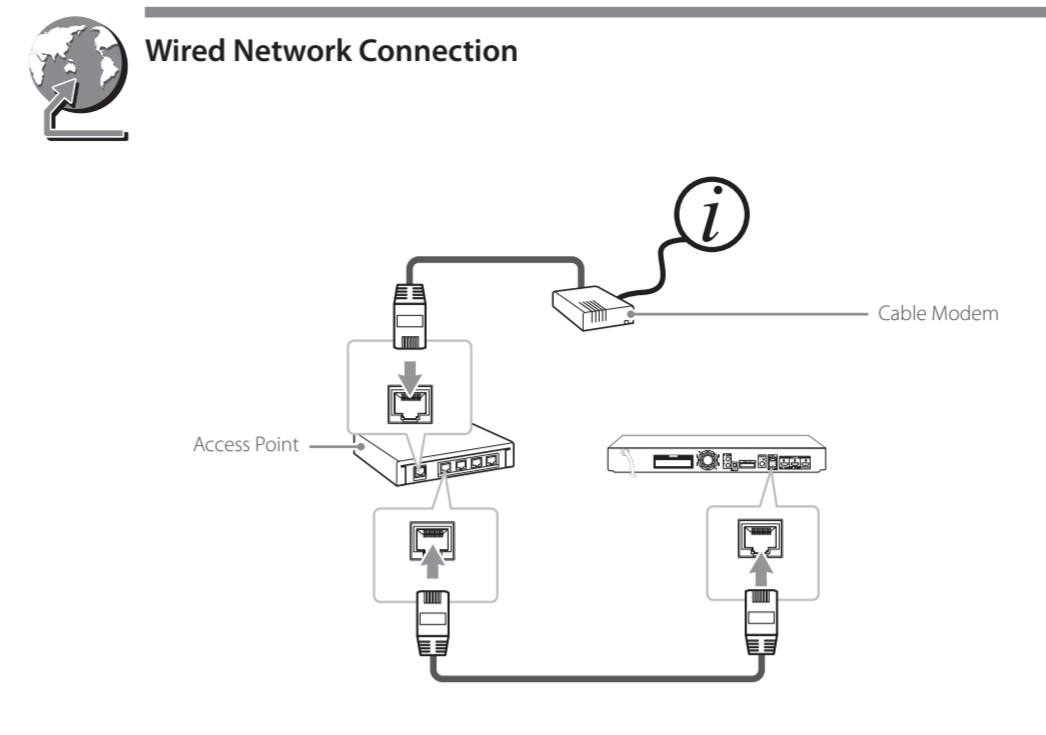
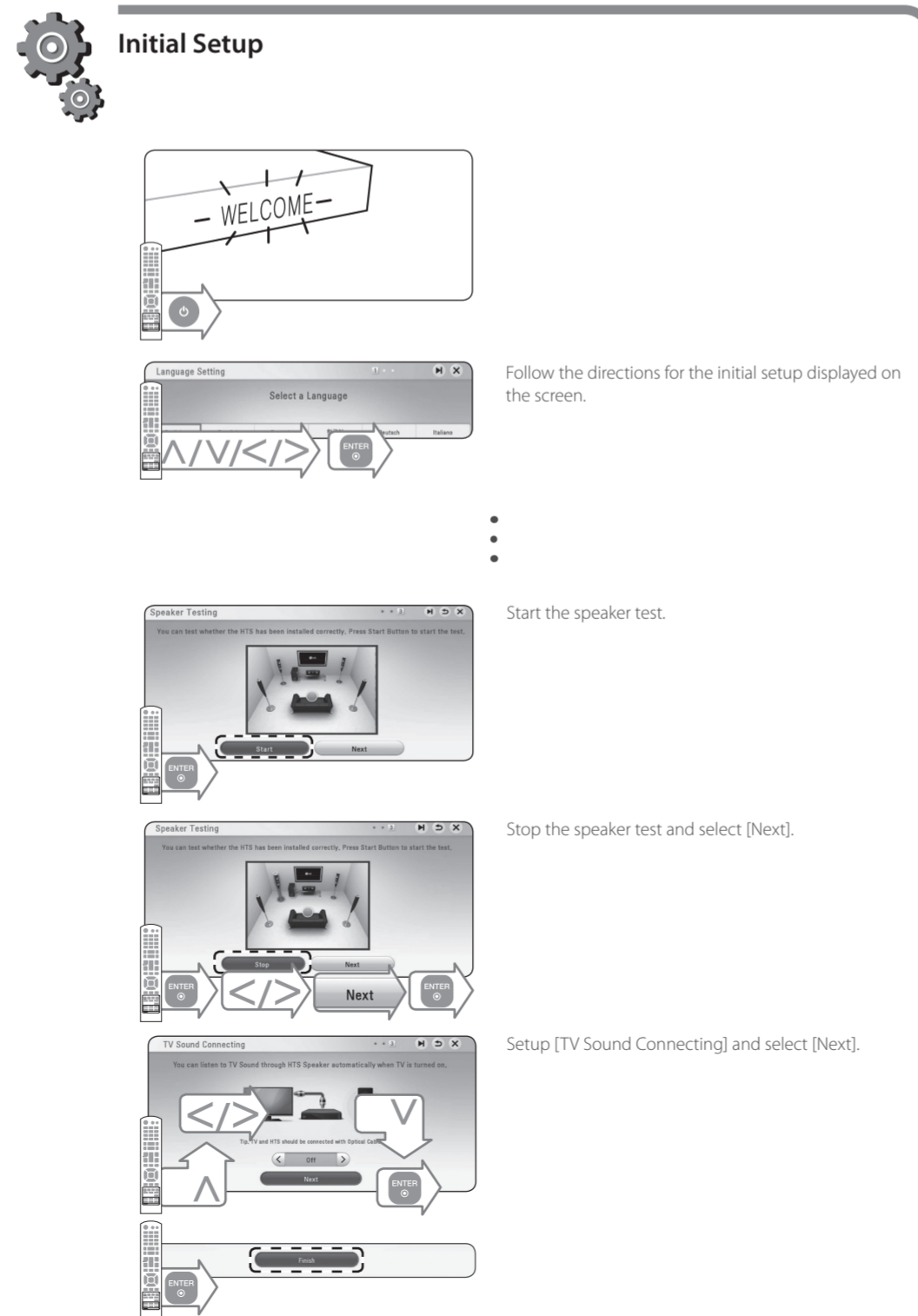
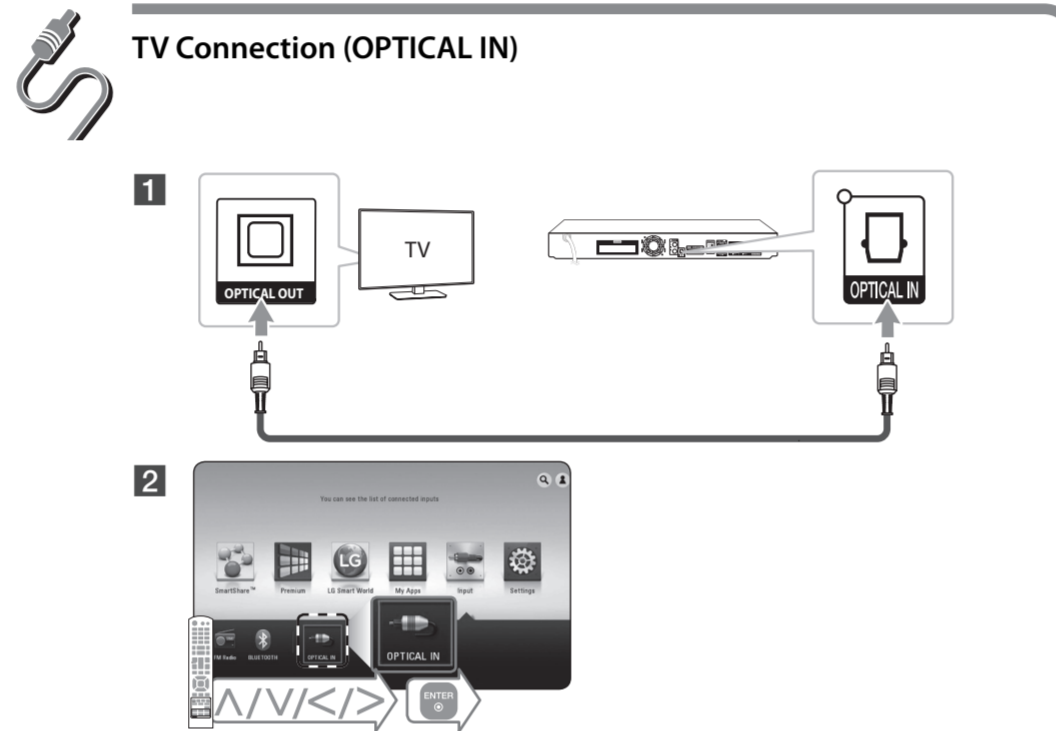
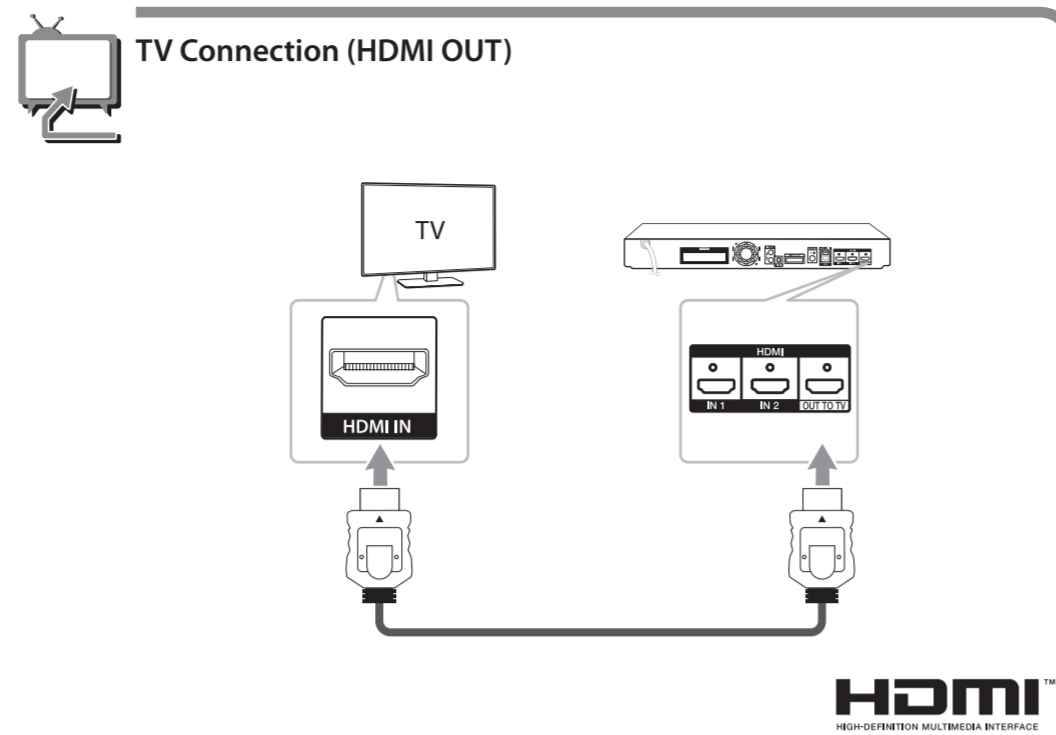



Network Playback

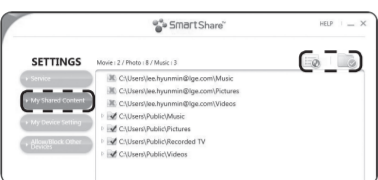

SmartShare PC software Installation

- 1 Install SmartShare PC software.

- 2  Run the program, and set the share folder you want.

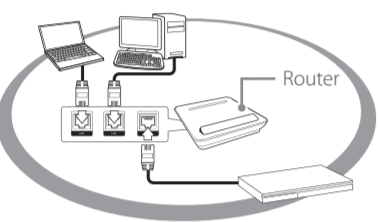
SmartShare Network Playback

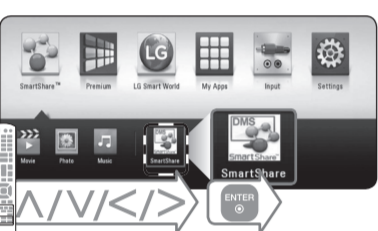
- 1  Check the network connection and settings.

- 2  



Additional Information

Customer Support





You can update the Player using the latest software to enhance the products operation and/or add new features. To obtain the latest software for this player (if updates have been made), proceed the software updates as written or visit <http://www.lg.com> or contact LG Electronics customer care center.

Open source software notice

To obtain the corresponding source code under GPL, LGPL and other open source licenses, please visit <http://opensource.lge.com>. All referred license terms, warranty disclaimers and copyright notices are available to download with the source code.

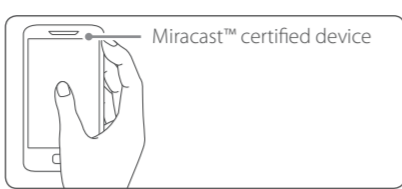

Enjoying Miracast

- 1  Miracast™ certified device Turn on the device and run its [Miracast] function.
- 2  
- 3 

- ! Depending on your wireless network condition, mirroring may be unstable.

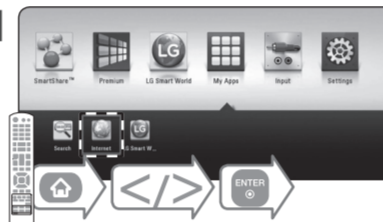

Enjoying Web browsing

- 1 Check the network connection and settings.
- 2 

- ! We recommend a minimum connection speed of 4 Mbps and playable file formats on web browsing are "jpeg", "png", "gif", "wmv", "asf", "wma", "mp3", "mp4".





Specification

Power requirements	Refer to main label on the rear panel.
Power consumption	Refer to main label on the rear panel.
Dimensions (W x H x D)	Approx. 444 mm x 65 mm X 292.5 mm
Net Weight (Approx.)	3.3 kg
Bus Power Supply (USB)	DC 5 V $\overline{\text{---}}$ 500 mA (Front) / DC 5 V $\overline{\text{---}}$ 300 mA (Rear)

Design and specifications are subject to change without notice.



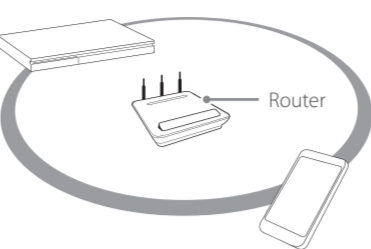

Enjoying Private Sound

- 1  Make sure that mobile device is connected to the same Wi-Fi network as this player.
- 2 Turn on the mobile device LG AV Remote App is Installed and run LG AV Remote App.
- 3 

- ! Not all modes support sound privacy and pairing multiple devices is not available.

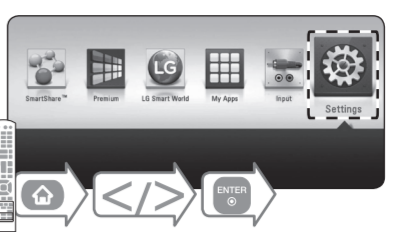

Software Update

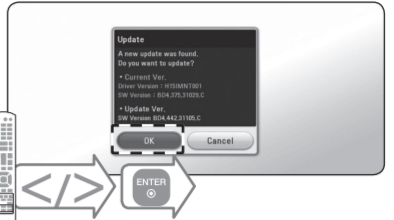
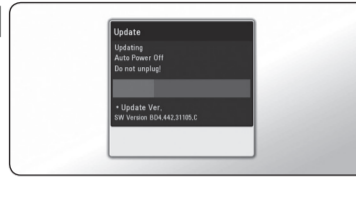
- 1 
- 2 
- 3 
- 4 



Safety Information

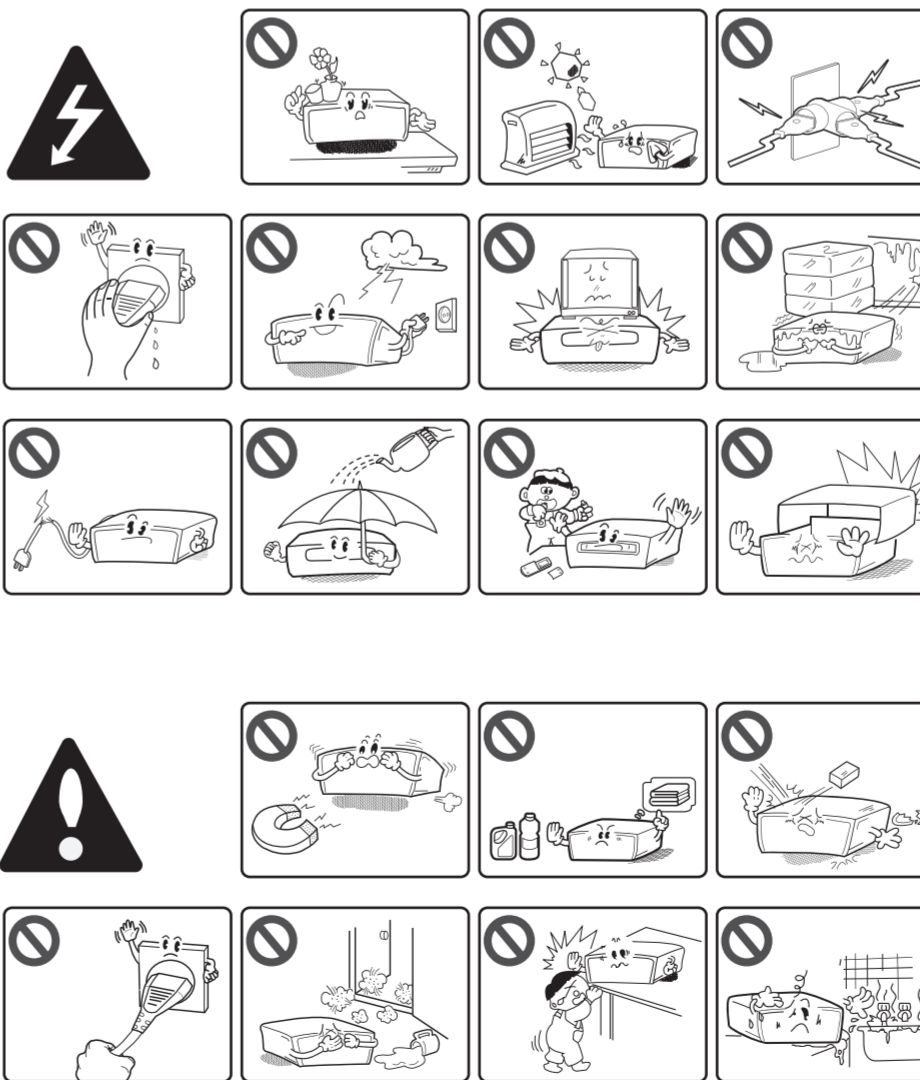

CAUTION RISK OF ELECTRIC SHOCK DO NOT OPEN

CAUTION: TO REDUCE THE RISK OF ELECTRIC SHOCK DO NOT REMOVE COVER (OR BACK) NO USER-SERVICEABLE PARTS INSIDE REFER SERVICING TO QUALIFIED SERVICE PERSONNEL.

This lightning flash with arrowhead symbol within an equilateral triangle is intended to alert the user to the presence of uninsulated dangerous voltage within the product's enclosure that may be of sufficient magnitude to constitute a risk of electric shock to persons.

The exclamation point within an equilateral triangle is intended to alert the user to the presence of important operating and maintenance (servicing) instructions in the literature accompanying the product.

WARNING: TO PREVENT FIRE OR ELECTRIC SHOCK HAZARD, DO NOT EXPOSE THIS PRODUCT TO RAIN OR MOISTURE.

WARNING: Do not install this equipment in a confined space such as a book case or similar unit.

CAUTION: Do not block any ventilation openings. Install in accordance with the manufacturer's instructions. Slots and openings in the cabinet are provided for ventilation and to ensure reliable operation of the product and to protect it from over heating. The openings shall be never be blocked by placing the product on a bed, sofa, rug or other similar surface. This product shall not be placed in a built-in installation such as a bookcase or rack unless proper ventilation is provided or the manufacturer's instruction has been adhered to.

Use of controls, adjustments or the performance of procedures other than those specified herein may result in hazardous radiation exposure.

CAUTION concerning the Power Cord

To disconnect power from the mains, pull out the mains cord plug. When installing the product, ensure that the plug is easily accessible.

CAUTION: The apparatus shall not be exposed to water (dripping or splashing) and no objects filled with liquids, such as vases, shall be placed on the apparatus.

This device is equipped with a portable battery or accumulator.

Safety way to remove the battery or the battery from the equipment: Remove the old battery or battery pack, follow the steps in reverse order than the assembly. To prevent contamination of the environment and bring on possible threat to human and animal health, the old battery or the battery put it in the appropriate container at designated collection points. Do not dispose of batteries or battery together with other waste. It is recommended that you use local, free reimbursement systems batteries and accumulators. The battery shall not be exposed to excessive heat such as sunshine, fire or the like.



- The appliance is not intended for use by young children or infirm persons without supervision.
- Young Children should be supervised to ensure that they do not play with appliance.
- If the appliance is supplied from a cord extension set or an electrical portable outlet device, the cord extension set on electrical portable outlet device must be positioned so that it is not subject to splashing or ingress of moisture.

RF Radiation Exposure Statement

This equipment should be installed and operated with minimum distance 20 cm between the radiator and your body.