

Network 3D Blu-ray Disc™ / DVD Player

BP540

ENGLISH | SIMPLE MANUAL

To view the instructions of advanced features, visit <http://www.lg.com> and then download Owner's Manual. Some of the content in this manual may differ from your unit.

DEUTSCH | KURZANLEITUNG

Anleitungen zu den erweiterten Funktionen finden in der Bedienungsanleitung, die Sie unter <http://www.lg.com> herunterladen können. Bestimmte Inhalte in dieser Bedienungsanleitung unterscheiden sich unter Umständen von Ihrem Gerät.

FRANÇAIS | MANUEL Simplifié

Pour connaître les instructions des fonctionnalités avancées, visitez le site <http://www.lg.com> et téléchargez le manuel d'utilisation. Il est possible qu'une partie du contenu de ce manuel diffère de votre lecteur.

ESPAÑOL | MANUAL SIMPLE

Para ver las instrucciones de las funciones avanzadas, visite <http://www.lg.com> y descargue el manual del propietario. Cierta contenido en este manual puede ser diferente del de su unidad.

ITALIANO | MANUALE SEMPLIFICATO

Per visualizzare le istruzioni delle caratteristiche avanzate, visita il sito <http://www.lg.com> e scarica il manuale del proprietario. Alcuni dei contenuti di questo manuale possono essere diversi da quelli del tuo lettore.

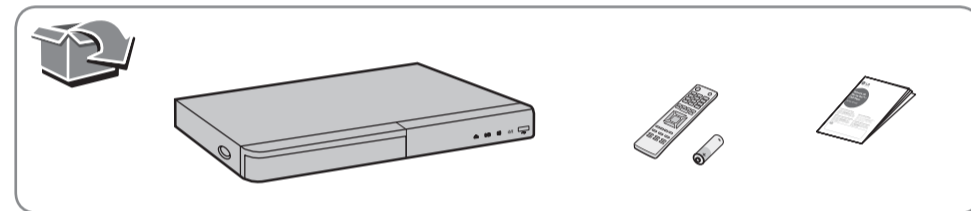

www.lg.com

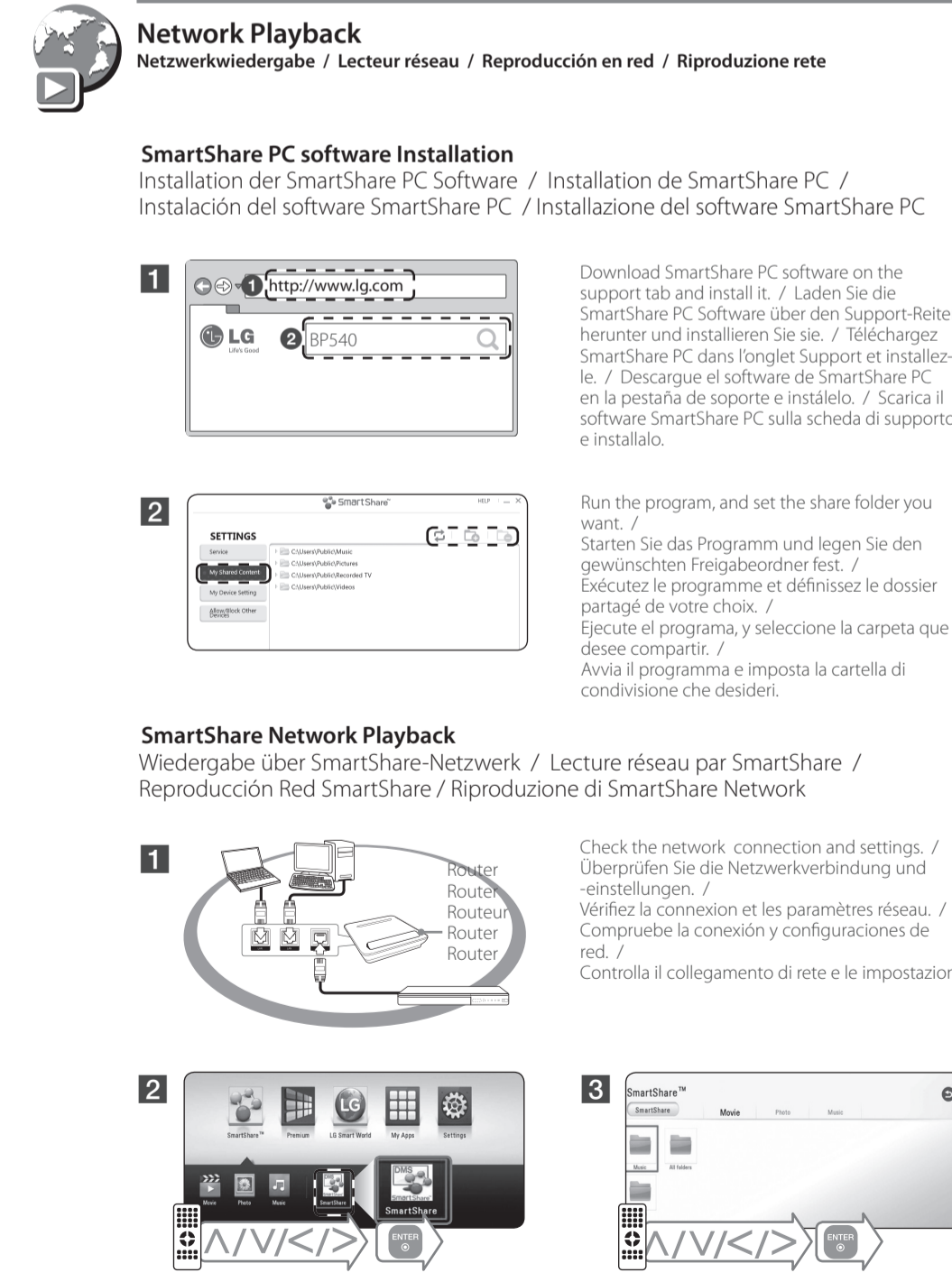
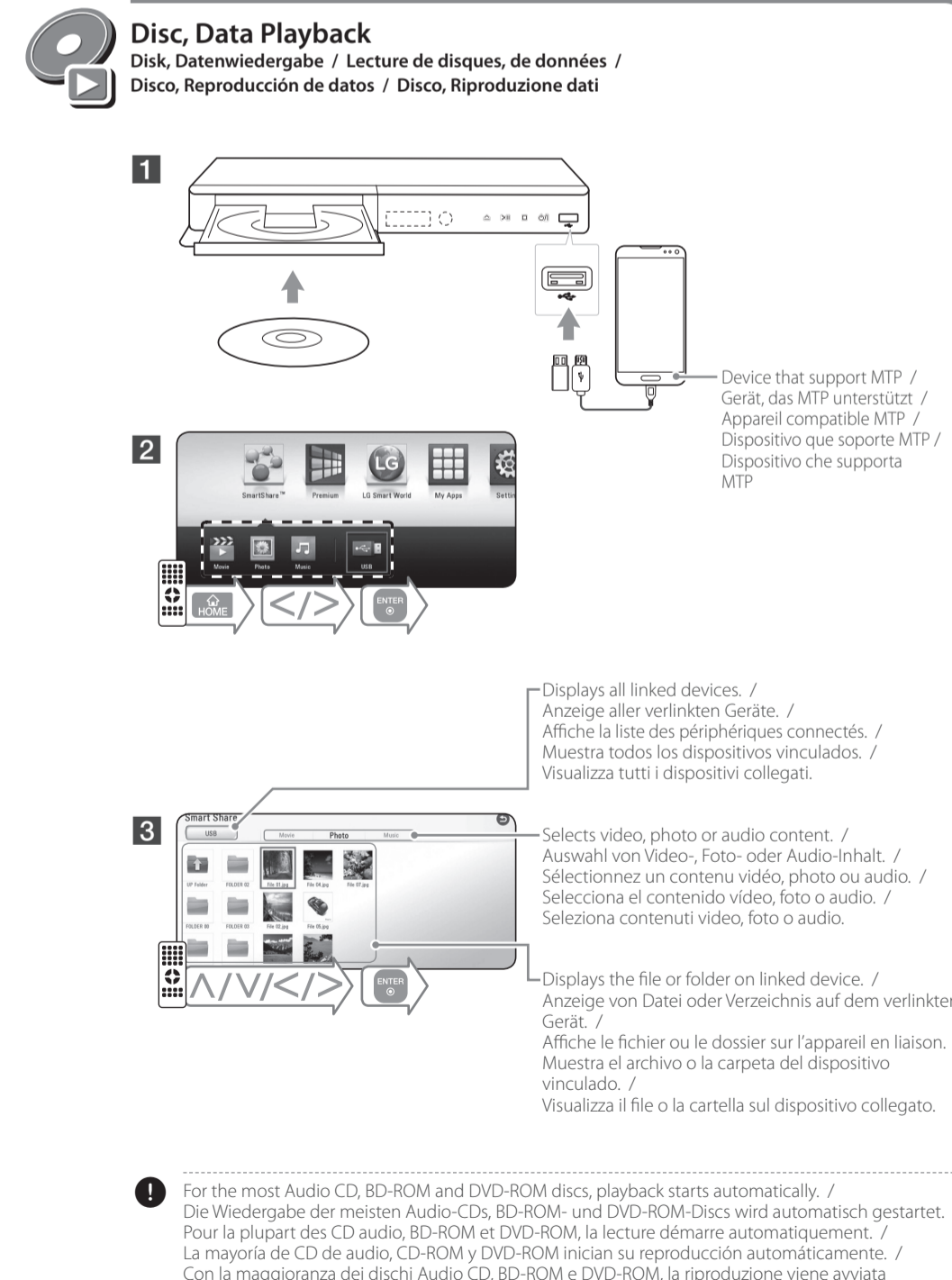
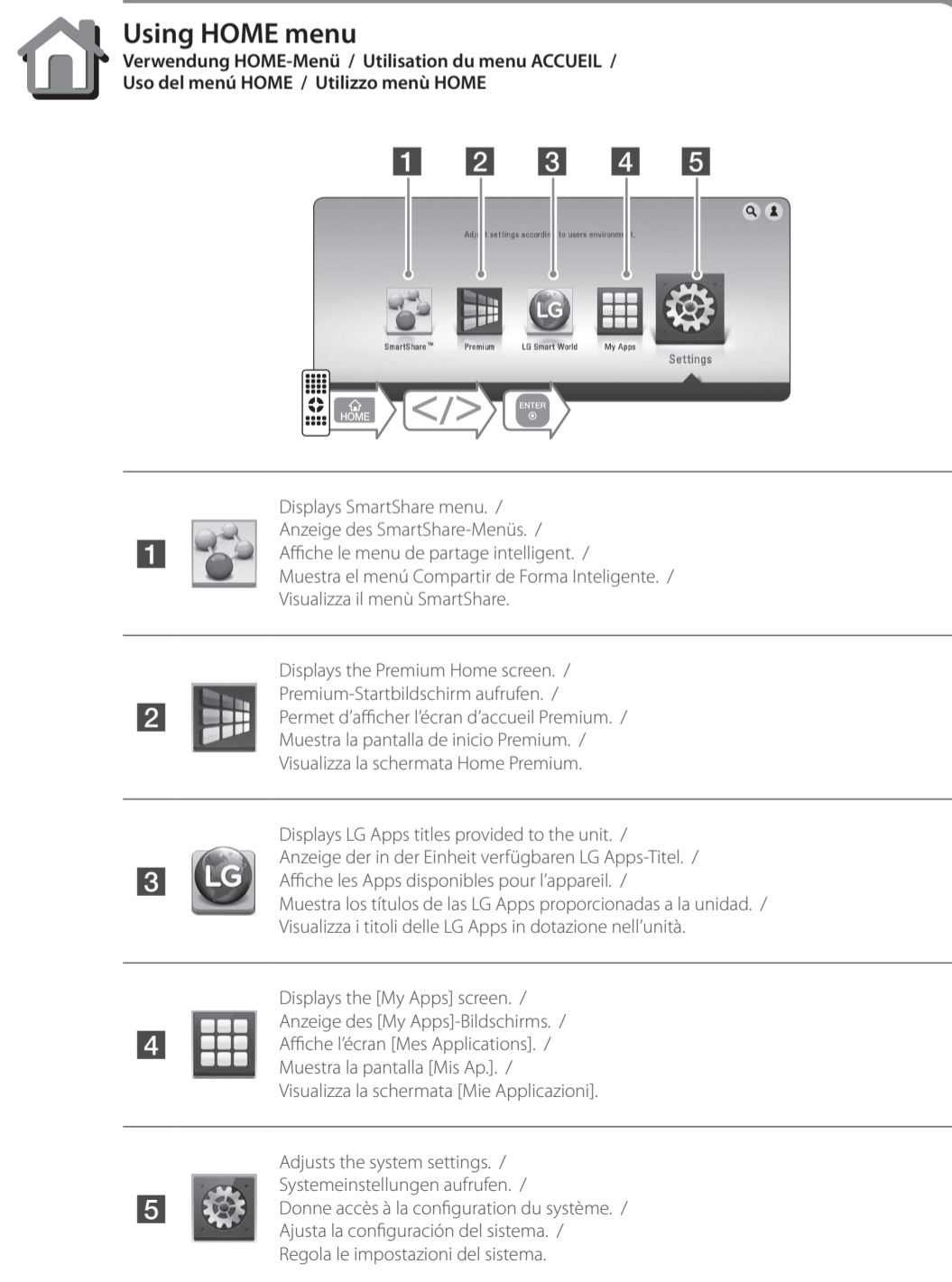
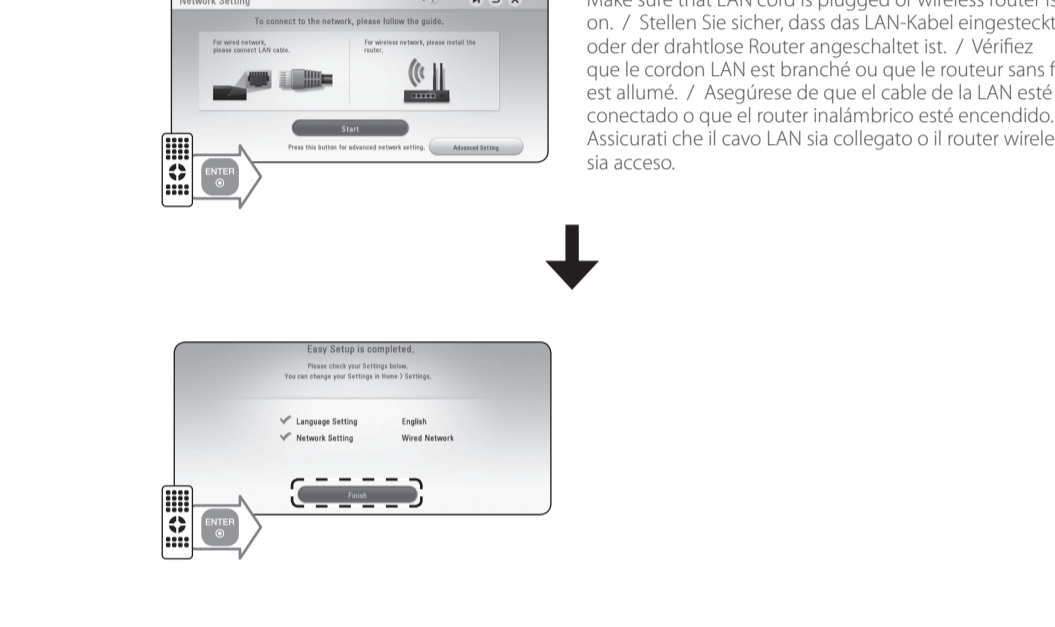
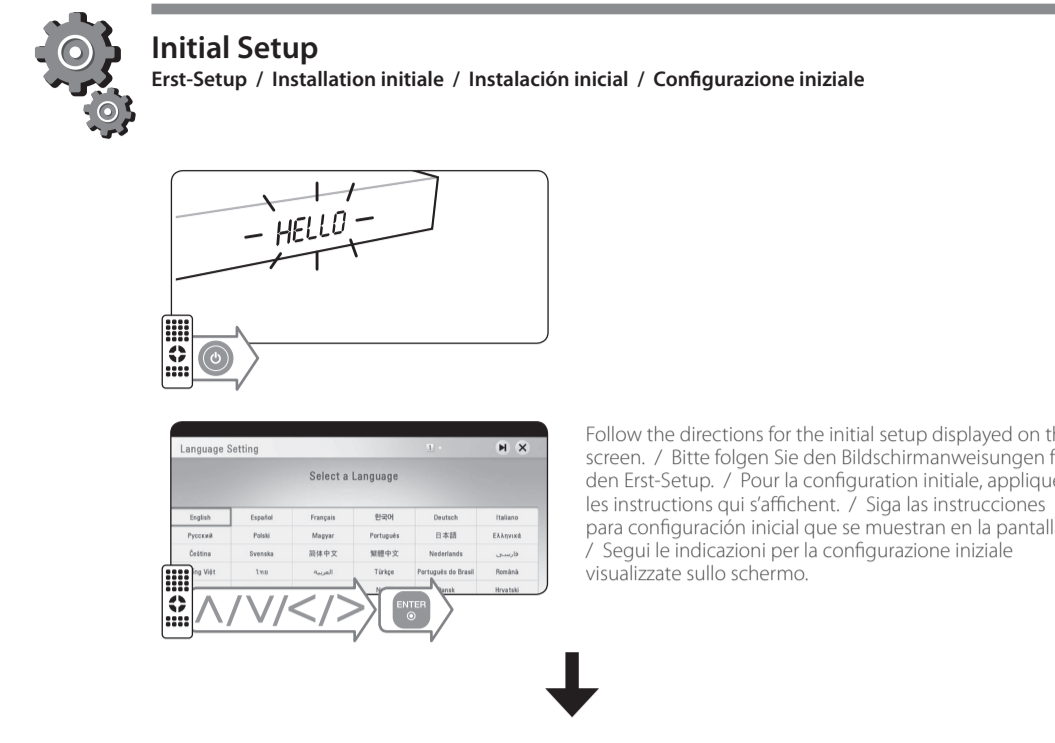
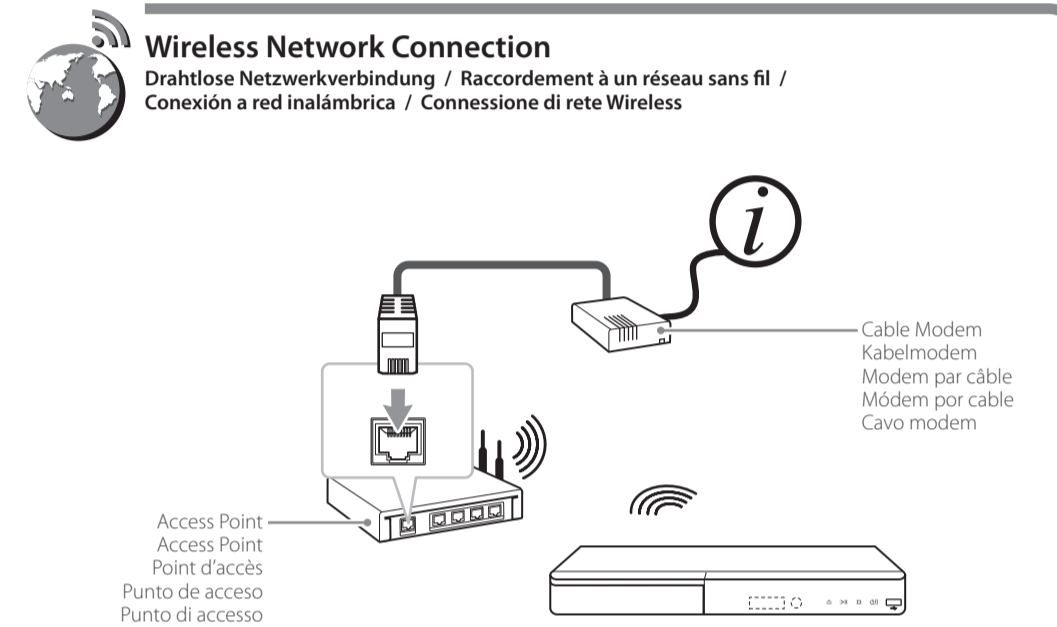
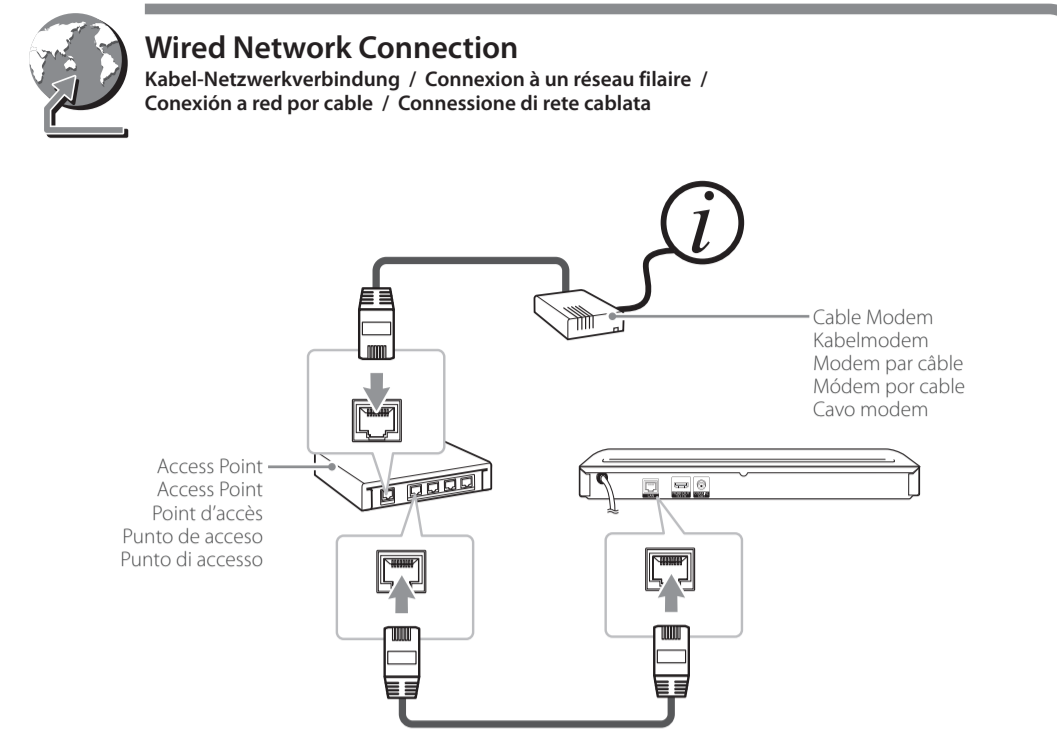
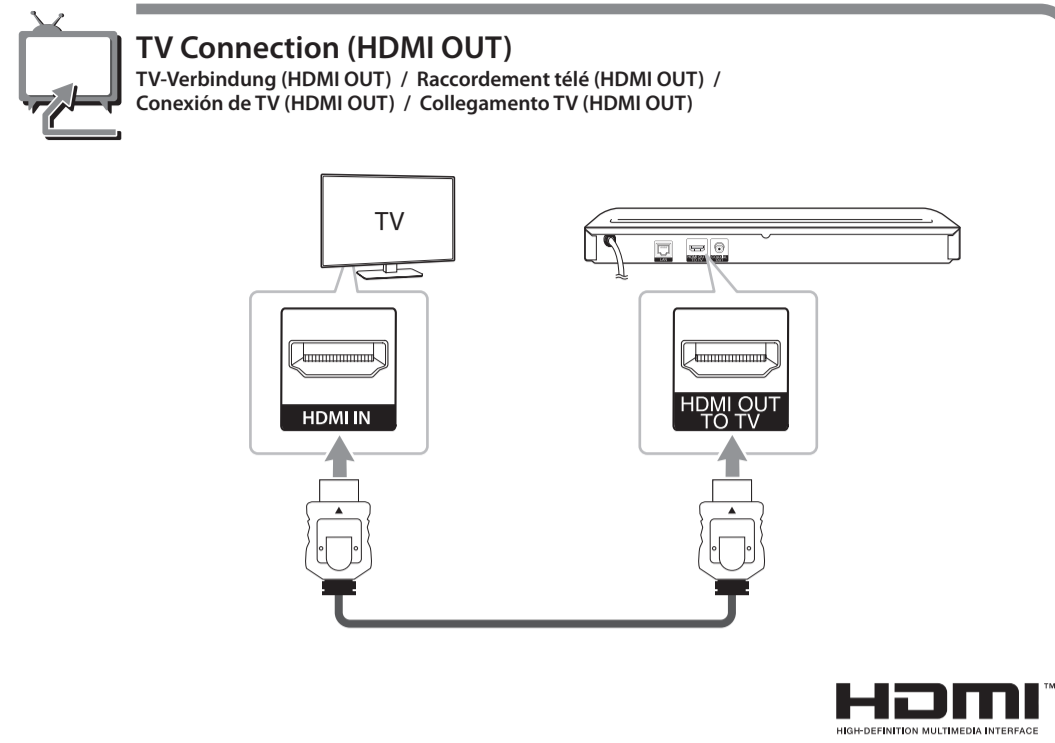



Enjoying Private Sound

Genießen Sie die "Private Sound"-Funktion / Transformez votre Smartphone en casque sans fi / Disfrute del sonido privado / Goditi Audio Privato

- Make sure that mobile device is connected to the same Wi-Fi network as this player. / Stellen Sie sicher, dass Ihr Mobilgerät mit demselben Wi-Fi-Netzwerk wie dieses Gerät verbunden ist. / Assurez-vous que votre appareil mobile est connecté au même réseau Wi-Fi que ce lecteur. / Asegúrese de que el dispositivo móvil esté conectado a la misma red Wi-Fi que el reproductor. / Assicurati che il tuo smartphone sia collegato alla stessa rete Wi-Fi di questo lettore multimediale.
- Turn on the mobile device LG AV Remote App is Installed and run LG AV Remote App. / Schalten Sie das Mobilgerät, auf dem die LG AV Remote-Anwendung installiert ist, an und öffnen Sie LG AV Remote. / Activez l'appareil mobile sur lequel est installée l'application LG AV Remote et exécutez cette application. / Encienda el dispositivo móvil LG en el que esté instalada la AV Remote y ejecútela. / Accendi il dispositivo mobile. Verifica che l'applicazione AV Remote di LG sia installata ed esegui AV Remote di LG.
- Not all modes support sound privacy and pairing multiple devices is not available. / Nicht alle Modi unterstützen die "Private Sound"-Funktion und das Verbinden von mehreren Geräten ist nicht verfügbar. / Tous les modes ne supportent pas le son en privé et l'appairage avec plusieurs appareils n'est pas possible. / No todos los modos son compatibles con el sonido privado y la vinculación de varios dispositivos podría no estar disponible. / Non tutte le modalità supportano l'audio privato e l'accoppiamento di più dispositivi non è disponibile.



Software Update

Software-Update / Mise à jour du logiciel / Actualización del software / Aggiornamento del software

-
-
-
-



Additional Information

Weitere Informationen / Informations supplémentaires / Información adicional / Informazioni aggiuntive

Customer Support

You can update the Player using the latest software to enhance the products operation and/or add new features. To obtain the latest software for this player (if updates have been made), proceed the software updates as written or visit <http://www.lg.com> or contact LG Electronics customer care center.

Kundendienst

Die Software des Players kann auf die neueste Version aktualisiert werden, um den Funktionsumfang zu erweitern und/oder neue Funktionen hinzuzufügen. Um die neueste Software-Version für diesen Player zu erhalten (falls Updates durchgeführt wurden), führen Sie wie beschrieben ein Software-Update durch, gehen Sie auf <http://www.lg.com> oder kontaktieren Sie das Kundendienst-Center von LG Electronics.

Support client

Vous pouvez mettre à jour le lecteur avec les derniers logiciels afin d'améliorer son fonctionnement et/ou afin d'ajouter de nouvelles fonctionnalités. Pour obtenir le logiciel le plus récent de ce lecteur (si des mises à jour sont disponibles), procédez comme indiqué ou allez sur <http://www.lg.com>. Vous pouvez également contacter le service clientèle de LG Electronics.

Asistencia al cliente

Es posible actualizar el reproductor con el software más reciente para mejorar el funcionamiento de los productos y/o agregar nuevas funciones. Para conseguir el software más reciente para este reproductor (en caso de que se hayan hecho actualizaciones), realice las actualizaciones de software como se muestra, entre en <http://www.lg.com> o póngase en contacto con el centro de atención al cliente de LG Electronics.

Assistenza clienti

Puoi aggiornare il lettore usando il software più recente per migliorare il funzionamento del prodotto e/o aggiungere nuove funzionalità. Per ottenere il software più recente per il player (se sono stati fatti gli aggiornamenti), effettua gli aggiornamenti software o visita www.lg.com o contatta il centro assistenza clienti di LG Electronics.

Open source software notice

To obtain the corresponding source code under GPL, LGPL and other open source licenses, please visit <http://opensource.lge.com>. All referred license terms, warranty disclaimers and copyright notices are available to download with the source code.

Hinweise zu Open Source-Software

Eine Kopie der GPL-, LGPL- und anderer Open Source-Genehmigungen finden Sie unter <http://opensource.lge.com>. Sämtliche angegebenen Lizenzbedingungen, Haftungsausschlüsse und Hinweise zum Urheberrecht stehen als Quellcode zum Download bereit.

Avis concernant les logiciels open source

Pour connaître le code source correspondant de GPL, LGPL et d'autres licences open source, rendez-vous sur <http://opensource.lge.com>. Les conditions de licence, les dénis de responsabilités et les avis concernant les droits d'auteur sont disponibles en téléchargement avec le code source.

Aviso sobre el software de código abierto

Para obtener el correspondiente código bajo la licencia de GPL, LGPL y otras licencias de código abierto, visite <http://opensource.lge.com>. Todos los terminos referidos, la exclusion de garantía y los avisos de copyright pueden descargarse con código abierto.

Nota di software di libera circolazione

Per ottenere il corrispondente codice di software di libera circolazione in base alle licenze GPL, LGPL e altre, visitate il sito <http://opensource.lge.com>. Tutti i termini relativi a licenza, rivendicazioni di garanzia e note di copyright sono disponibili per lo scaricamento con il codice di sorgente.



Specification

Technische Daten / Spécifications / Especificaciones / Specifiche

ENGLISH

Power requirements	200 - 240 V ~ 50 / 60 Hz
Power consumption	12 W
Dimensions (W x H x D)	Approx. 360 mm x 41.5 mm x 200 mm
Net Weight (Approx.)	1.4 kg
Bus Power Supply (USB)	5 V $\overline{\text{---}}$ 500 mA

Design and specifications are subject to change without notice.

DEUTSCH

Stromversorgung	200 - 240 V ~ 50 / 60 Hz
Leistungsaufnahme	12 W
Abmessungen (B x H x T)	Ca. 360 mm x 41.5 mm x 200 mm
Gesamtgewicht (ca.)	1,4 kg
Stromversorgung über Bus (USB)	5 V $\overline{\text{---}}$ 500 mA

Änderungen der Ausführung und der technischen Daten ohne vorherige Ankündigung vorbehalten.

FRANÇAIS

Alimentation	200 - 240 V ~ 50 / 60 Hz
Consommation électrique	12 W
Dimensions (L x H x P)	Approximativement 360 mm x 41.5 mm x 200 mm
Poids net (approx.)	1,4 kg
Bus Power Supply (USB)	5 V $\overline{\text{---}}$ 500 mA

La conception et les spécifications sont sujettes à modification sans préavis.

ESPAÑOL

Requisitos de alimentación	200 - 240 V ~ 50 / 60 Hz
Consumo de energía	12 W
Dimensiones (A x Alt x F)	Aprox. 360 mm x 41.5 mm x 200 mm
Peso neto (aprox.)	1,4 kg
Alimentación bus (USB)	5 V $\overline{\text{---}}$ 500 mA

El diseño y las especificaciones están sujetas a cambio sin previo aviso.

ITALIANO

Requisiti di alimentazione	200 - 240 V ~ 50 / 60 Hz
Assorbimento energetico	12 W
DIMENSIONI (L x A x P)	Approx. 360 mm x 41.5 mm x 200 mm
Peso netto (approssimativo)	1,4 kg
Alimentazione tensione bus (USB)	5 V $\overline{\text{---}}$ 500 mA

Il design e le specifiche tecniche sono soggette a cambiamento senza preavviso.



Safety Information

Sicherheitshinweise / Consignes de sécurité / Información de seguridad / Informazioni di sicurezza

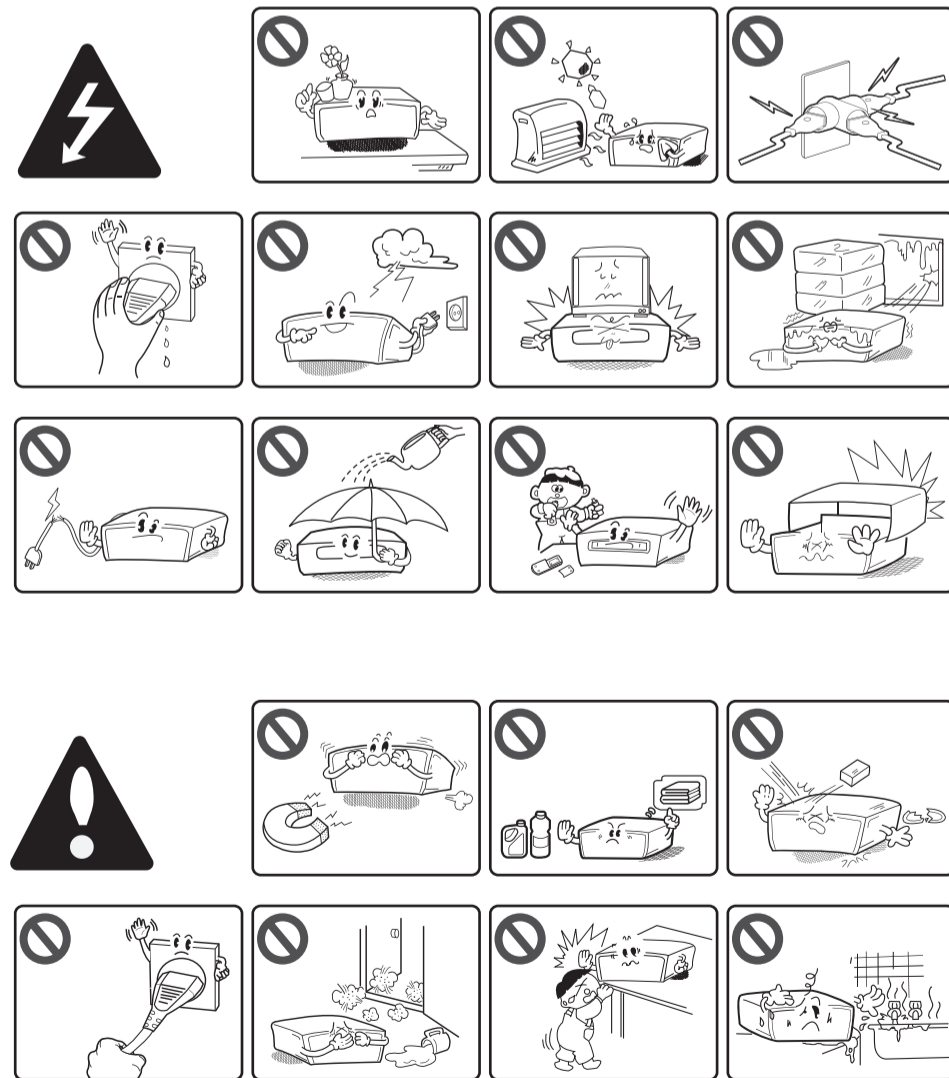

CAUTION: TO REDUCE THE RISK OF ELECTRIC SHOCK DO NOT REMOVE COVER (OR BACK) NO USER-SERVICEABLE PARTS INSIDE REFER SERVICING TO QUALIFIED SERVICE PERSONNEL.

This lightning flash with arrowhead symbol within an equilateral triangle is intended to alert the user to the presence of uninsulated dangerous voltage within the product's enclosure that may be of sufficient magnitude to constitute a risk of electric shock to persons.

The exclamation point within an equilateral triangle is intended to alert the user to the presence of important operating and maintenance (servicing) instructions in the literature accompanying the product.

WARNING: TO PREVENT FIRE OR ELECTRIC SHOCK HAZARD, DO NOT EXPOSE THIS PRODUCT TO RAIN OR MOISTURE.

WARNING: Do not install this equipment in a confined space such as a book case or similar unit. **CAUTION:** Do not block any ventilation openings. Install in accordance with the manufacturer's instructions. Slots and openings in the cabinet are provided for ventilation and to ensure reliable operation of the product and to protect it from over heating. The openings shall be never be blocked by placing the product on a bed, sofa, rug or other similar surface. This product shall not be placed in a built-in installation such as a bookcase or rack unless proper ventilation is provided or the manufacturer's instruction has been adhered to.

Use of controls, adjustments or the performance of procedures other than those specified herein may result in hazardous radiation exposure.

CAUTION concerning the Power Cord To disconnect power from the mains, pull out the mains cord plug. When installing the product, ensure that the plug is easily accessible.

CAUTION: The apparatus shall not be exposed to water (dripping or splashing) and no objects filled with liquids, such as vases, shall be placed on the apparatus.

This device is equipped with a portable battery or accumulator. **Safety way to remove the battery or the battery from the equipment:** Remove the old battery or battery pack, follow the steps in reverse order than the assembly. To prevent contamination of the environment and bring on possible threat to human and animal health, the old battery or the battery put it in the appropriate container at designated collection points. Do not dispose of batteries or battery together with other waste. It is recommended that you use local, free reimbursement systems batteries and accumulators. The battery shall not be exposed to excessive heat such as sunshine, fire or the like.

Disposal of your old appliance

- When this crossed-out wheeled bin symbol is attached to a product it means the product is covered by the European Directive 2002/96/EC.
- All electrical and electronic products should be disposed of separately from the municipal waste stream via designated collection facilities appointed by the government or the local authorities.
- The correct disposal of your old appliance will help prevent potential negative consequences for the environment and human health.
- For more detailed information about disposal of your old appliance, please contact your city office, waste disposal service or the shop where you purchased the product.

Disposal of waste batteries/accumulators

- When this crossed-out wheeled bin symbol is attached to batteries/accumulators of Your product it means they are covered by European Directive 2006/66/EC.
- This symbol may be combined with chemical symbols for mercury(Hg), cadmium(Cd) or lead(Pb) if the battery Contains more than 0.0005% of mercury, 0.002% of cadmium or 0.004% of lead.
- All batteries/accumulators should be disposed separately from the municipal waste stream via designated collection facilities appointed by the government or the local authorities.
- The correct disposal of your old batteries/accumulators will help to prevent potential negative consequences for the environment, animal and human health.
- For more detailed information about disposal of Your old batteries/accumulators, please contact Your city office, waste disposal service or the shop where You purchased the product.

For Wireless product European Union Notice

CE 0984 LG Electronics hereby declares that this/these product(s) is/are in compliance with the essential requirements and other relevant provisions of Directive 1999/5/EC, 2004/108/EC, 2006/95/EC, 2009/125/EC and 2011/65/EU. Please contact to the following address for obtaining a copy of the DoC (Declaration of Conformity).

Contact office for compliance of this product:

LG Electronics Inc.
EU Representative, Krijgsman 1,
1186 DM Amstelveen, The Netherlands

Please note that this is NOT a Customer Service contact point. For Customer Service Information, see Warranty Card or contact the dealer that you purchased this product.

Indoor use only.

RF Radiation Exposure Statement

This equipment should be installed and operated with minimum distance 20 cm between the radiator and your body.

