

OWNER'S MANUAL

High Definition Network Dome Camera

Please read this manual carefully before operating your set and retain it for future reference.

MODEL

LND5100 series



Specification

Item	LND5100 series	
Image Device	6.08 mm (1/3 type) Progressive Scan CMOS (1.3 Mega Pixels)	
Lens Type	2.8 mm to 10 mm F1.2	
Day/Night	ICR	
Minimum Illumination	Color	0.3 lx (F1.2, Sens-up off) 0.01 lx (F1.2, Sens-up x60)
	B/W	0.005 lx (F1.2, Sens-up off) 0.000 1 lx (F1.2, Sens-up x60)
WDR	Support	
Image Enhancement	Backlight Compensation, 2D+3D-DNR, Exposure Control, Sens Up Control, AGC, White Balance, Privacy Masking, EIS, Sharpness, Digital Zoom, Scene mode	
Video Analytics	Motion detection, Intelligent motion detection, Trip zone, Object counting, Streaming metadata	
Resolution (Maximum)	Up to 1 280 x 1 024	
Output	RJ-45 (Network), RCA (Installation)	
Frame Rate (Maximum)	30 fps @ 1 280 x 1 024, 30 fps @ 720p	
Compression	H.264_HIGH, H.264, MJPEG	
Multi-Streaming	Dynamic Profile (Up to 7)	
ROI (Region of Interest)	Support	
Audio In/Out	1/1	
Audio Compression	G.711, G.726	
2-way Audio	Support	
SD Slot	Micro SD	
EVENT	Alarm In/Out	1/1
	Event Notification	Relay Out, Email, FTP
	Pre Event Buffering	Support

Integrated Client	LV510	
Remote S/W	LV510, Mobile application (iPhone, Android, iPad)	
Connections	Up to 10	
Security	Password Protection, HTTPS(SSL, TLS), IEEE 802.1X	
Ethernet	10/100 Ethernet	
Protocol	IPv4 and IPv6	TCP/IP, UDP, HTTP, HTTPS, RTP, RTSP, DHCP, ICMP
	IPv4	FTP, SMTP, NTP, ARP, SNMP v1/v2c/v3, DDNS(LG)
Open Protocol	ONVIF 2.2 Profile S, PSIA 1.1	
Operation Temperature/Humidity	-10 °C to 50 °C / 0 % RH to 80 % RH	
Power Source	PoE, DC 12 V	
Power Consumption	5.9 W	
Input current	DC 12 V	Maximum 440 mA
	PoE	Maximum 140 mA
Dimension (Ø x H)	140 mm x 120 mm	
Weight	610 g	

This Class A digital apparatus complies with Canadian ICES-003.
Cet appareil numérique de la classe A est conforme à la norme NMB-003 du Canada.

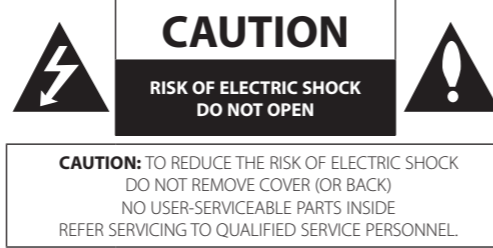

This lightning flash with arrowhead symbol within an equilateral triangle is intended to alert the user to the presence of uninsulated dangerous voltage within the product's enclosure that may be of sufficient magnitude to constitute a risk of electric shock to persons.



The exclamation point within an equilateral triangle is intended to alert the user to the presence of important operating and maintenance (servicing) instructions in the literature accompanying the product.

FCC WARNING: This equipment may generate or use radio frequency energy. Changes or modifications to this equipment may cause harmful interference unless the modifications are expressly approved in the instruction manual. The user could lose the authority to operate this equipment if an unauthorized change or modification is made.

REGULATORY INFORMATION: FCC Part 15

This equipment has been tested and found to comply with the limits for a Class A digital device, pursuant to Part 15 of the FCC Rules. These limits are designed to provide reasonable protection against harmful interference when the equipment is operated in a commercial environment. This equipment generates, uses, and can radiate radio frequency energy and, if not installed and used in accordance with the instruction manual, may cause harmful interference to radio communications.

Operation of this equipment in a residential area is likely to cause harmful interference in which case the user will be required to correct the interference at his own expense.

- A suitable conduit entries, knock-outs or glands shall be provided in the cable entries of this product in the end user.
- Caution: Danger of explosion if battery is incorrectly replaced. Replaced only with the same or equivalent type recommended by the manufacturer. Dispose of used batteries according to the manufacturer's instructions.
- Holes in metal, through which insulated wires pass, shall have smooth well rounded surfaces or shall be provided with brushings.

Warning: Do not install this equipment in a confined space such as a bookcase or similar unit.

Warning: Wiring methods shall be in accordance with the National Electric Code, ANSI/NFPA 70.

Warning: This is a class A product. In a domestic environment this product may cause radio interference in which case the user may be required to take adequate measures.

Warning: To reduce a risk of fire or electric shock, do not expose this product to rain or moisture.

Caution: This installation shall be made by a qualified service person and shall conform to all local codes.

Caution: To avoid electrical shock, do not open the cabinet. Refer servicing to qualified personnel only.

Caution: The apparatus shall not be exposed to water (dripping or splashing) and no objects filled with liquids, such as vases, shall be placed on the apparatus.

To disconnect power from mains, pull out the mains cord plug. When installing the product, ensure that the plug is easily accessible.

CE LG Electronics hereby declares that this/these product(s) is/are in compliance with the essential requirements and other relevant provisions of Directive 2004/108/EC and 2011/65/EU.

Contact office for compliance of this product :

LG Electronics Inc.
EU Representative, Krijgsman 1,
1186 DM Amstelveen, The Netherlands

Disposal of your old appliance



1. When this crossed-out wheeled bin symbol is attached to a product it means the product is covered by the European Directive 2002/96/EC.
2. All electrical and electronic products should be disposed of separately from the municipal waste stream via designated collection facilities appointed by the government or the local authorities.
3. The correct disposal of your old appliance will help prevent potential negative consequences for the environment and human health.
4. For more detailed information about disposal of your old appliance, please contact your city office, waste disposal service or the shop where you purchased the product.

EEE Compliance with Directive. (for Turkey only)

Important Safety Instructions

1. Read these instructions.
2. Keep these instructions.
3. Heed all warnings.
4. Follow all instructions.
5. Do not use this apparatus near water.
6. Clean only with dry cloth.
7. Do not block any ventilation openings. Install in accordance with the manufacturer's instructions.

8. Do not install near any heat sources such as radiators, heat registers, stoves, or other apparatus (including amplifiers) that produce heat.
9. Do not defeat the safety purpose of the polarized or grounding-type plug. A polarized plug has two blades with one wider than the other. A grounding type plug has two blades and a third grounding prong. The wide blade or the third prong are provided for your safety. If the provided plug does not fit into your outlet, consult an electrician for replacement of the obsolete outlet.
10. Protect the power cord from being walked on or pinched particularly at plugs, convenience receptacles, and the point where they exit from the apparatus.
11. Only use attachments/accessories specified by the manufacturer.
12. Use only with the cart, stand, tripod, bracket, or table specified by the manufacturer, or sold with the apparatus. When a cart is used, use caution when moving the cart/apparatus combination to avoid injury from tip-over.



13. Unplug this apparatus during lightning storms or when unused for long periods of time.
14. Refer all servicing to qualified service personnel. Servicing is required when the apparatus has been damaged in any way, such as power-supply cord or plug is damaged, liquid has been spilled or objects have fallen into the apparatus, the apparatus has been exposed to rain or moisture, does not operate normally, or has been dropped.

Handling of the unit

Be careful not to spill water or other liquids on the unit. Be cautious not to get combustible or metallic material inside the body. If used with foreign matter inside, the camera is liable to fail or to get cause of fire or electric shock.

- Remove dust or dirt on the surface of the lens with a blower.
- Use a dry soft cloth to clean the body. If it is very dirty, use a cloth dampened with a small quantity of neutral detergent then wipe dry.
- Avoid the use of volatile solvents such as thinners, alcohol, benzene and insecticides. They may damage the surface finish and/or impair the operation of the camera.
- This camera is designed for mounting on the ceiling or wall. If you install this camera upside down, it may cause malfunction.

Operating and storage location

Avoid viewing a very bright object (such as light fittings) during an extended period. Avoid operating or storing the unit in the following locations.

- Extremely hot or cold places (operating temperature -10 °C to 50 °C, however, we recommend that the unit be used within a temperature range of 0 °C to 45 °C)
- Damp or dust place
- Places exposed to rain
- Places subject to strong vibration
- Close to generators of powerful electromagnetic radiation such as radio or TV transmitters.
- Do not use the camera in such place where rapid temperature fluctuation by switching an air conditioner on and off.

Part Names and Functions

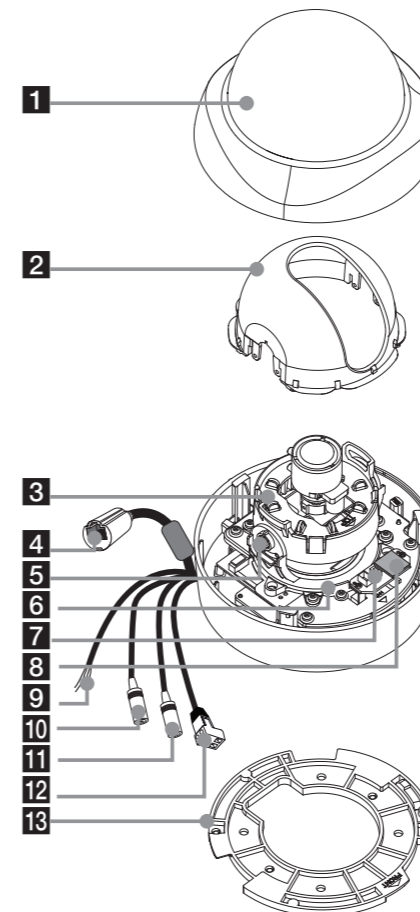

- 1 **Dome Cover**
- 2 **Lens Cover**
- 3 **Azimuth adjuster**
- 4 **ETHERNET/PoE Port**

Connects to a PC or a network via a hub with a 10 BASE-T/100 BASE-TX cable attached RJ-45 connector.

NOTE:

Power over Ethernet (PoE) is a technology that integrates power into a standard LAN infrastructure. It enables power to be provided to the network device, such as a network camera, using the same cable as that used for network connection. It eliminates the need for power outlets at the device locations and enables easier application of uninterruptible power supplies (LPS).

- 5 **Tilting lock screw**
- 6 **Pan adjuster**

Adjusts the pan position.

- 7 **RESET button**
- Push the button more than 3 seconds, this would restore the factory default network related settings.

- 8 **micro SD card slot**
- Insert the micro SD card.

- 9 **ALARM IN / ALARM IN RETURN**
- Provides physical interface for sensor.

ALARM OUT / ALARM OUT RETURN
Provides physical interface for Alarm/Relay.

- 10 **AUDIO OUT (Line Level Output)**
- 11 **AUDIO IN (Line Level Input)**
- 12 **Power input terminal**

Connects to a DC 12 V power supply using proper cables. This camera must always be operated a DC 12 V. Certified/Listed Adaptor which comply with LPS.

- 13 **Camera mounting bracket**

Connection

Precautions

- Be sure to switch off the unit before installation and connection.
- The installation should be made by qualified service personnel or system installers.
- Do not expose the power and connection cables to moisture, which may cause damage to the unit.

Connecting Network

You can control and monitor the system via network. With the remote control (monitoring), you can change the system configuration or monitor the image via network. After the installation, check the network settings for the remote control and monitoring work.

Connect the IP camera to your network using a standard RJ-45 network cable as shown below.

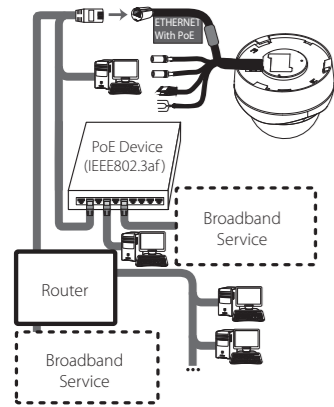

Connecting Power Source

Connect power, using one of the methods listed below:

To use the power adapter

Connect a DC 12 V power source to the power input terminal as shown below. (recommended power adapter is DC 12 V/1.5 A or above)

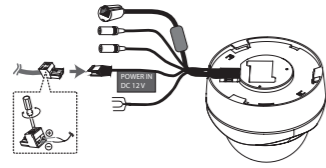

NOTE:

When the connecting Alarm and Audio, tighten the screws as shown above.

To use the PoE (Power over Ethernet) device

Connect the PoE cable to the LAN port on the unit. You must use the "IEEE802.3af" standard PoE device.

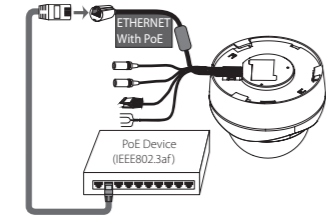

NOTE:

If the camera doesn't work properly after connecting PoE device, please check if the PoE device supplies enough power.

Connecting Alarm Device

Alarm terminals are used to connect the alarm (relay) devices such as sensors, door switches, etc.

ALARM IN / ALARM IN RETURN (Sensor Input)

Connect the sensor device to the sensor input terminal.

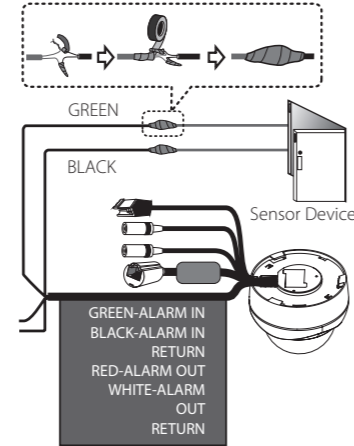

ALARM OUT / ALARM OUT RETURN (Relay Output)

Connect the alarm (relay) device to the relay output terminal. Alarm signal is outputted at an event occurrence.

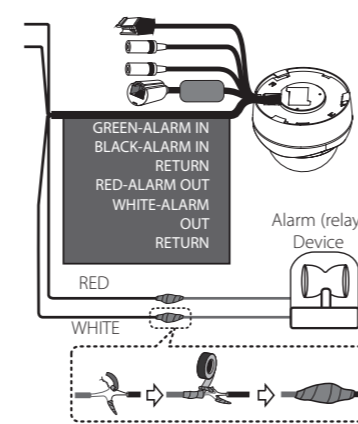

NOTE:

The Photo MOS Relay is rated for 100 mA at 20 V DC or 100 mA at 28 V AC.

Connecting Microphone and Speaker Device

Optionally connect an active speaker and/or external microphone with a built-in amplifier.

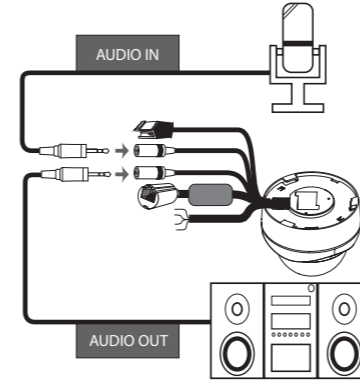

NOTE:

Keep the microphone away from the speaker to avoid howling.

Using the micro SD card

You can record your surveillance environment with the micro SD card even if the network is disconnected condition.

To insert the micro SD card

- Remove the Dome Cover.
- Insert the micro SD card carefully as shown in the following illustrations. Make sure the micro SD card terminal position before insert the micro SD card. Push the back end of the micro SD card to fix it at the last step.

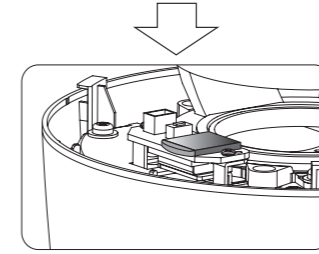
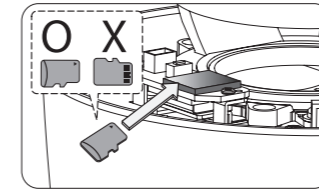

NOTES:

- Do not use the power too much when you insert the micro SD card. The micro SD card may be damaged.
- If you insert the micro SD card in the wrong position, the micro SD card may be damaged or it may cause the malfunction of the micro SD Card Slot.
- Keep the terminal part of the micro SD card in clean. Be careful the terminal part of the micro SD card not to dusty.
- As the micro SD card is consumable, the micro SD card end its days and may be not able to save data if you use it more than over certain times. In this case, replace micro SD card to buy a new one.

Remove the micro SD card

- Press the back end of the micro SD card to release the lock condition.

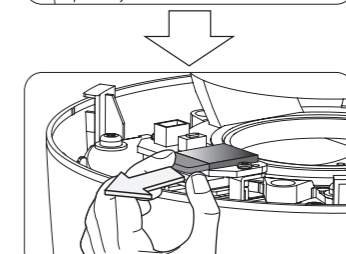
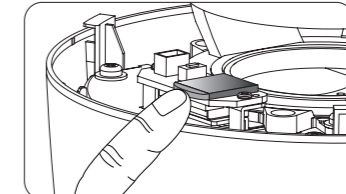

- Take the micro SD card out carefully from the camera. It may cause a malfunction of the micro SD card or the micro SD card slot if you use the power too much at lock status.

CAUTION:

- If you install the micro SD card on the camera and remove with the micro SD card condition indicator lights on, you must unmount the micro SD card by using the [System > Storage > Device Management > Unmount] menu. The micro SD card data is compromised or the camera may not operate normally, if you remove the card without use [Unmount] function.
- LG Electronics is not responsible for deleted data caused by user mishandling when you insert or remove the micro SD card.

Recommended the micro SD card specification

Maker	Capacity	Block Size (FAT 32)
LG	Less than 32 GB	32 kbyte
Sandisk		
Transcend		

NOTE:

Speed of reading and writing more than 10 MB/Sec. (Class 6)

Mounting the camera

Follow the instructions below to install the camera with camera mounting bracket.

- Use the installation guide template to check the mounting location. Face the front of the label toward the area of interest. Using the template as a guide, make a hole through the ceiling.

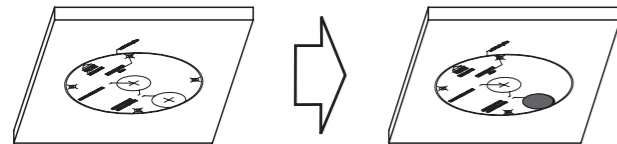

CAUTION:

Install on a ceiling or wall where can withstand the weight of 5 times of the camera including mounting bracket.

- Install the camera mounting bracket to the ceiling.

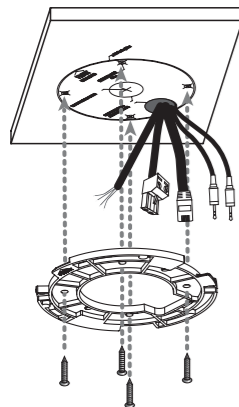

- Connect the cables to the cable jacks of the camera body.

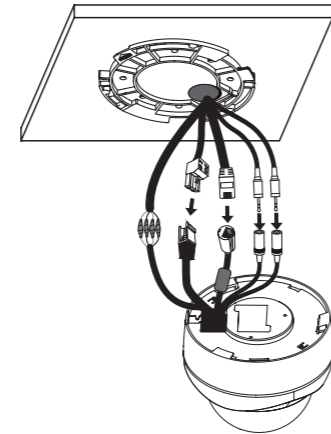

NOTE:

To disassemble the camera from the mounting bracket, rotate the camera counterclockwise with pressing the PUSH button inside the camera body.

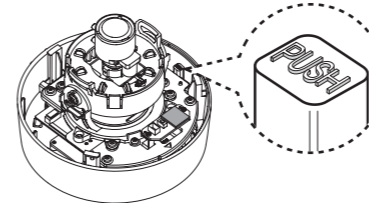

Camera Adjustment

- Connect the portable monitor to the video jack using the test monitor cable.

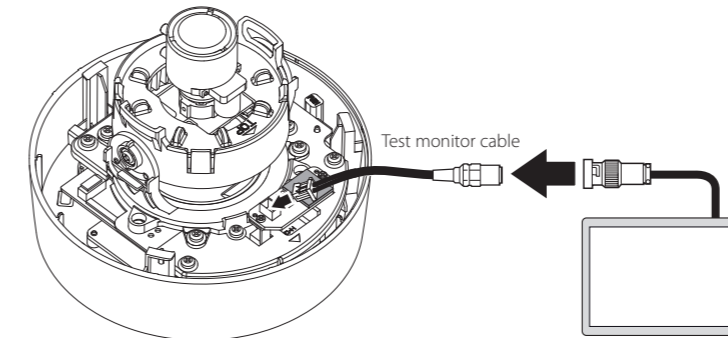

- Adjust the pan/tilt/rotation position of the camera.

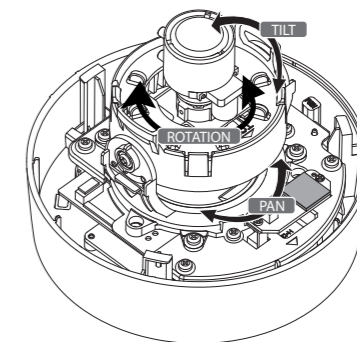

- Adjust the zoom and focus.

