

Network 3D Blu-ray Disc™ / DVD Player

BP440

PORTUGUÊS | MANUAL SIMPLES

Para visualizar instruções sobre funcionalidades avançadas, visite <http://www.lg.com> e transfira o Manual do Proprietário. Alguns conteúdos presentes neste manual podem não ter correspondência com a unidade.

NEDERLANDS | EENVOUDIGE HANDLEIDING

Om de instructies voor geavanceerde functies weer te geven, gaat u naar <http://www.lg.com>, waar u vervolgens de gebruikershandleiding kunt downloaden. Sommige delen van deze gebruikershandleiding kunnen niet van afwijken van uw product.

Ελληνικά | ΑΠΛΟ ΕΓΧΕΙΡΙΔΙΟ

Για να δείτε τις οδηγίες για τις προηγμένες λειτουργίες, επισκεφθείτε τη διεύθυνση <http://www.lg.com> και κατεβάστε το Εγχειρίδιο του Κατόχου. Ορισμένο από το περιεχόμενο σε αυτό το εγχειρίδιο μπορεί να διαφέρει για τη συσκευή σας.

SLOVENŠČINA | ENOSTAVNI PRIROČNIK

Če si želite ogledati navodila za napredne funkcije, obiščite <http://www.lg.com> in prenesite navodila za uporabo. Nekateri vsebini v tem priročniku se lahko razlikujejo od vaše enote.

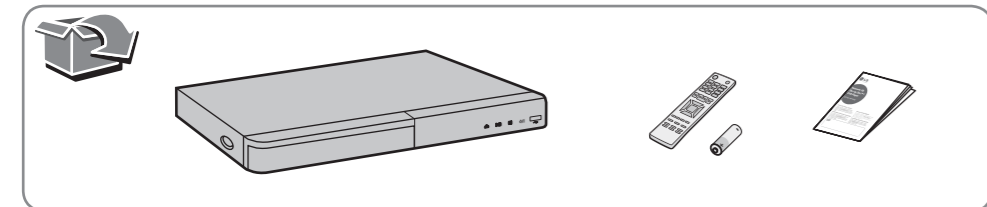
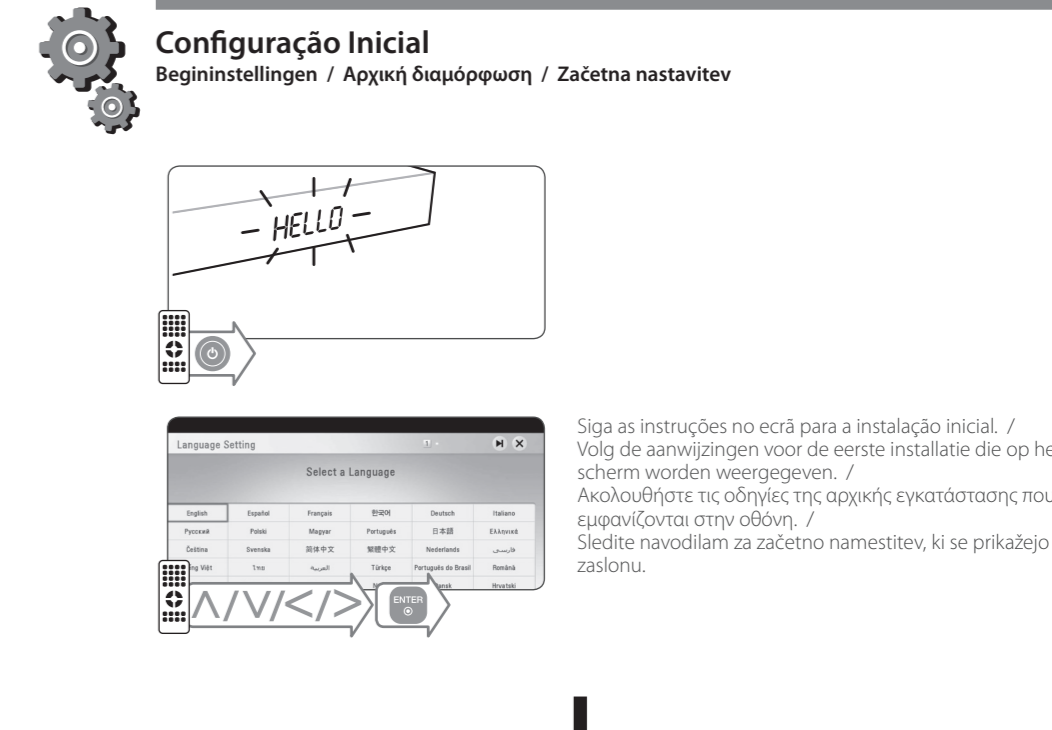
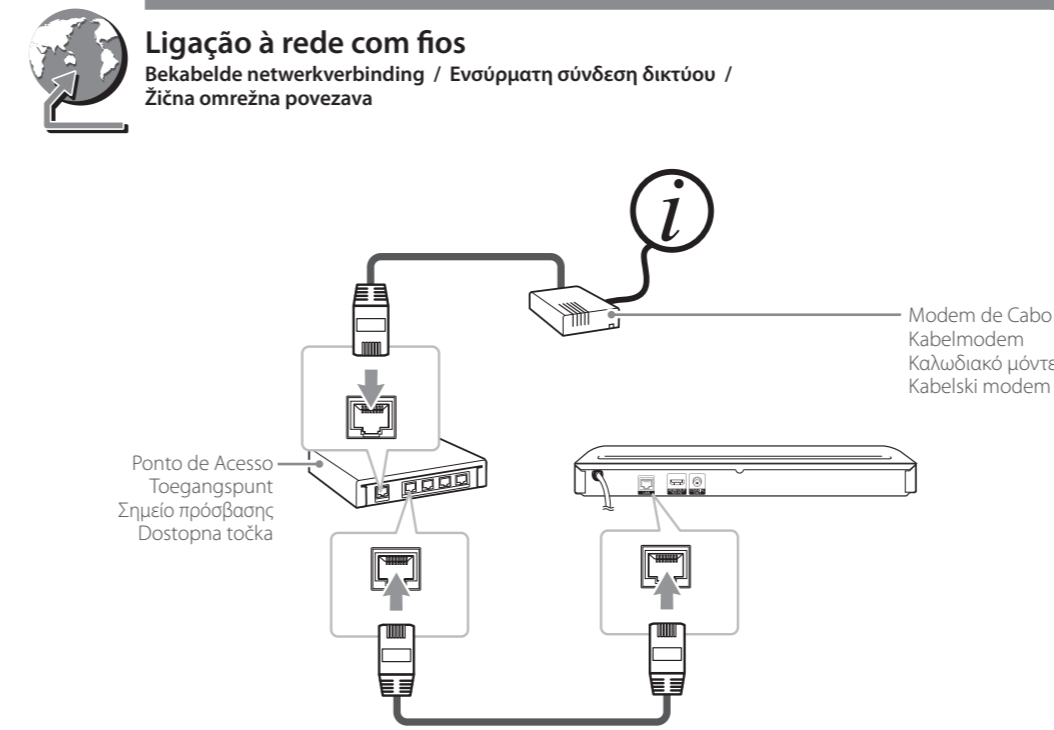
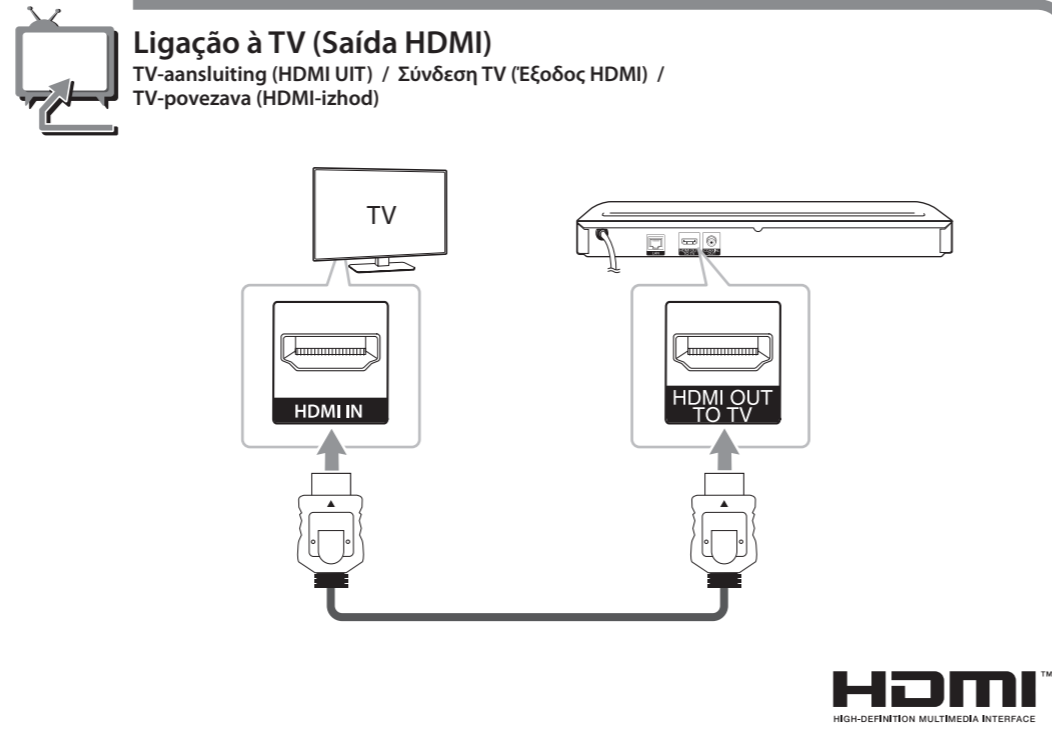

www.lg.com

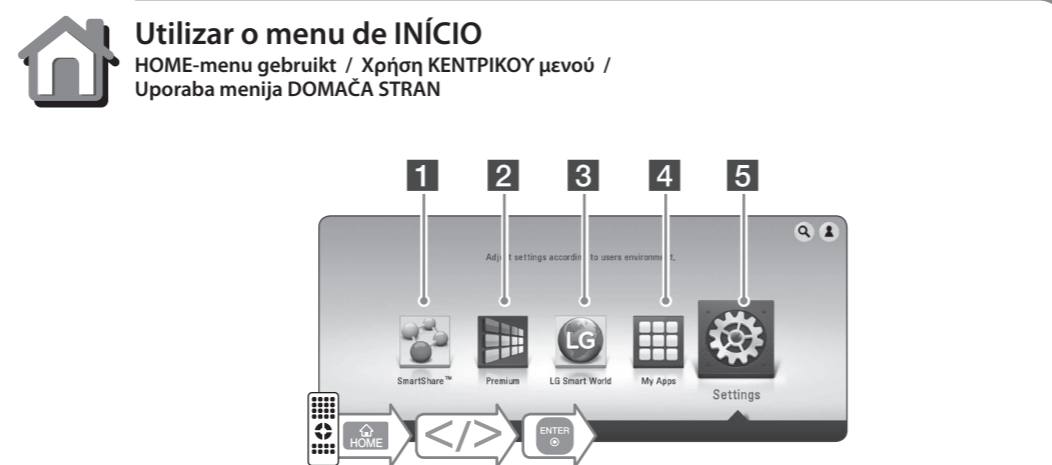

- 1 Exibe o menu SmartShare. / Toont het SmartShare menu. / Εμφάνιση μενού SmartShare. / Prikaže meni "SmartShare".
- 2 Exibir o écran inicial do Premium. / Dit laat het Premium Home scherm zien. / Προβάλλει την αρχική οθόνη Premium. / Prikaže domači zaslon Premium.
- 3 Exibe os títulos LG Apps fornecidos à unidade. / Toont de aan het apparaat verstrekte titels van de LG Apps. / Εμφάνιση τίτλων συνοδευτικών εφαρμογών LG Apps. / Prikaže naslove LG Apps, ki so dostopni na tej enoti.
- 4 Exibe o ecrã as [As Minhas Aplicações]. / Toont het [Mijn Apps] scherm. / Εμφάνιση οθόνης [My Apps]. / Prikaže zaslon [My Apps].
- 5 Ajusta as configurações do sistema. / De systeeminstellingen aanpassen. / Ορίζει τις ρυθμίσεις του συστήματος. / Nastavitve sistemskih nastavitve.



- 1 Exibe todos os dispositivos conectados. / Toont alle gekoppelde apparaten. / Εμφάνιση όλων των συνδεδεμένων συσκευών. / Prikaže vse povezane naprave.
- 2 Seleciona vídeo, fotografia ou conteúdo de áudio. / Selecteert video-, foto- en audiocontent. / Επιλογή βίντεο, φωτογραφίας ή ηχητικού περιεχομένου. / Izbere video datoteke, fotografije ali audio vsebino.
- 3 Exibe o ficheiro ou pasta no dispositivo conectado. / Toont het bestand of de map op het gekoppelde apparaat. / Εμφάνιση του αρχείου ή του φακέλου στη συνδεδεμένη συσκευή. / Prikaže datoteko ali mapo povezane naprave.

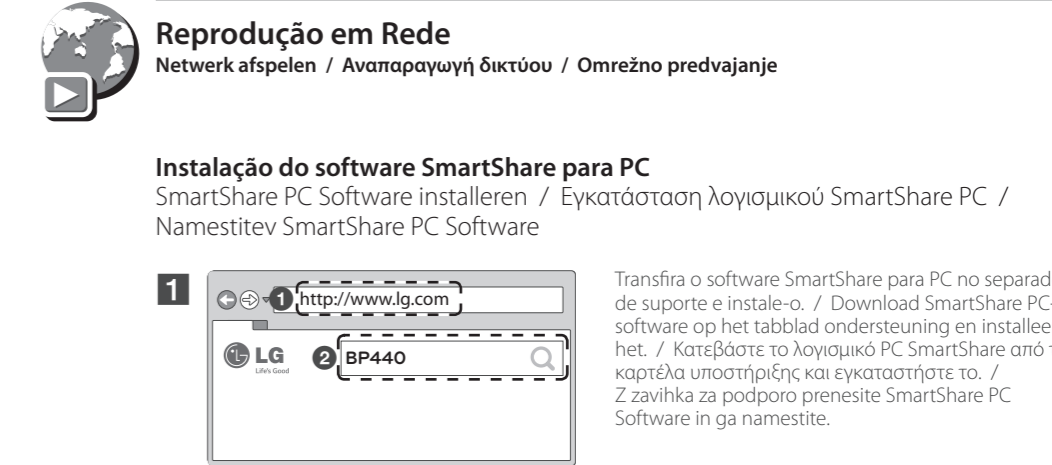

- 1 Instalação do software SmartShare para PC. / SmartShare PC Software installeren. / Εγκατάσταση λογισμικού SmartShare PC. / Namestitev SmartShare PC Software. / Transfira o software SmartShare para PC no separador de suporte e instale-o. / Download SmartShare PC-software op het tabblad ondersteuning en installeer het. / Κατεβάστε το λογισμικό PC SmartShare από την καρτέλα υποστήριξης και εγκαταστήστε το. / Z zavilka za podporo prenesite SmartShare PC Software in ga namestite.
- 2 Execute o programa e defina a pasta de partilha que desejar. / Start het Programma en stel de gewenste gedeelde map in. / Τρέψτε το πρόγραμμα και ορίστε το φάκελο κοινής χρήσης που θέλετε. / Zaženite program in namestite mapo za skupno rabo.
- 3 Reprodução em Rede SmartShare. / Afspeelen via Smart Share Network. / Αναπαραγωγή δικτύου Smart Share. / Omrežno predvajanje z uporabo funkcije SmartShare. / Verifique as definições e a ligação de rede. / Controleer de netwerk aansluiting en de instellingen. / Ελέγξτε τη σύνδεση και τις ρυθμίσεις δικτύου. / Preverite omrežno povezavo in nastavitve.



Desfrutar de Som Privado

Van Private Sound genieten / Απολαύστε τον ήχο στα μέτρα σας / Uživatej v zasebnostnem zvoku

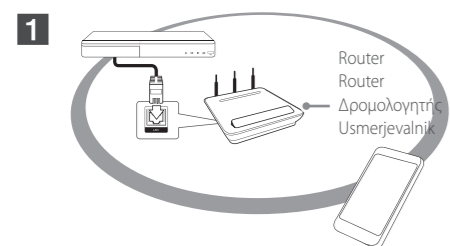

Certifique-se de que o dispositivo móvel está ligado à mesma rede Wi-Fi deste leitor. / Zorg ervoor dat uw mobiele apparaat verbonden is met hetzelfde Wi-Fi-netwerk als deze speler. / Βεβαιωθείτε ότι το smartphone σας είναι συνδεδεμένο στο ίδιο δίκτυο Wi-Fi με αυτή τη συσκευή αναπαραγωγής. / Prepričajte se, da je pametni telefon povezan z istim omrežjem Wi-Fi kot ta predvajalnik.

2 Ative e execute a aplicação LG AV Remote instalada no dispositivo móvel. / Zet de app LG AV Remote aan. Deze wordt geïnstalleerd en voert dan de LG AV Remote uit. / Ενεργοποιήστε την εγκατεστημένη εφαρμογή απομακρυσμένου ελέγχου για κινητά LG και εκτελέστε την εφαρμογή LG AV Remote. / Vključite mobilno napravo, na kateri je nameščena aplikacija LG AV Remote in zaženite aplikacijo LG AV Remote.



3 Nem todos os modelos suportam som privado e o emparelhamento de vários dispositivos não está disponível. / Niet alle modi ondersteunen privégeluid en koppelen van meerdere apparaten is niet beschikbaar. / Δεν υποστηρίζουν όλες οι λειτουργίες προσαρμογής ήχου και η ζεύξη πολλαπλών συσκευιών δεν είναι διαθέσιμη. / Vse naprave ne podpirajo zasebnostnega zvoka, zato vzpostavitev povezave med napravami ni bo na voljo.



Atualização de Software

Software-update / Ενημέρωση λογισμικού / Posodobitev programske opreme

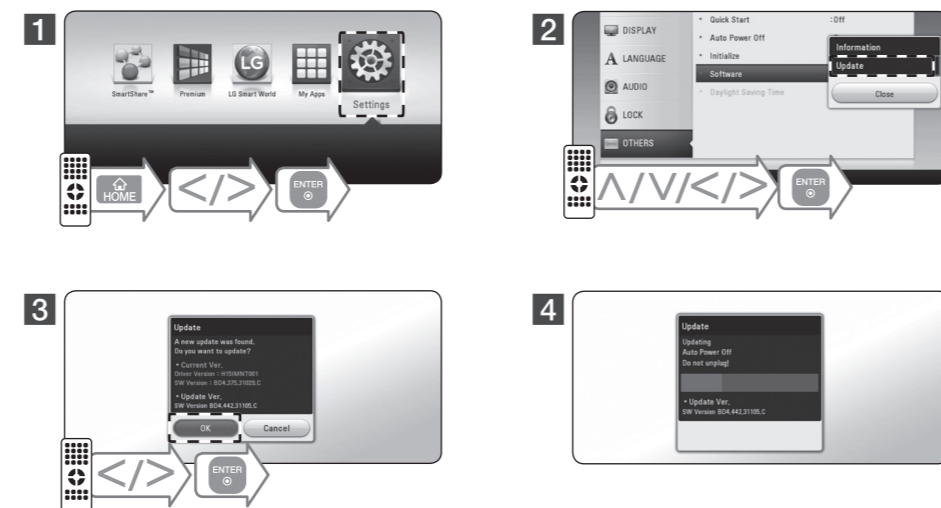

Informação Adicional

Aanvullende informatie / Πρόσθετες πληροφορίες / Dodatne informacije

Apoio ao Cliente

Pode atualizar o leitor utilizando o software mais recente para melhorar o funcionamento dos produtos e/ou adicionar novas funcionalidades. Para obter o software mais recente para este leitor (caso existam atualizações), siga as instruções para a atualização do software conforme descrito, visite <http://www.lg.com> ou contate o centro de apoio ao cliente da LG Electronics.

Klantenondersteuning

Met behulp van de nieuwste software kunt u de speler bijwerken om de werking ervan te verbeteren en/of nieuwe functies toe te voegen. Om de laatste softwareversie voor deze speler te verkrijgen (wanneer er updates beschikbaar zijn), dient u de software-updates, zoals hierboven omschreven, voort te zetten. U kunt ook <http://www.lg.com> bezoeken of contact opnemen met het klantcontactcentrum van LG Electronics.

Υποστήριξη πελατών

Μπορείτε να ενημερώσετε τη συσκευή με το τελευταίο λογισμικό, ώστε να βελτιώσετε τη λειτουργία του προϊόντος και/ή να προσθέσετε νέα χαρακτηριστικά. Για να αποκτήσετε την τελευταία έκδοση του λογισμικού για αυτή τη μονάδα αναπαραγωγής (στην περίπτωση που έχουν υπάρξει ενημερώσεις), εκτελέστε την ενημέρωση λογισμικού όπως αναφέρεται παραπάνω, ή επισκεφθείτε τη διεύθυνση <http://www.lg.com> ή επικοινωνήστε με το κέντρο εξυπηρέτησης της LG Electronics.

Podpora za stranko

Predvajalnik lahko posodobite z najnovejšo programsko opremo, ki lahko izboljša delovanje izdelka in/ali mu doda nove funkcije. Da pridobite najnovejšo programsko opremo za ta predvajalnik (če so bile narejene posodobitve), nadaljujte s posodobitvami programske opreme, kot je navedeno zgoraj, ali obiščite <http://www.lg.com> ali se obrnite na center za pomoč strankam LG Electronics.

Notas sobre software de código aberto

Para obter a fonte de código correspondente sob as licenças GPL, LGPL e outras, visite <http://opensource.lge.com>. Todos os termos de licença, garantias e avisos de direitos de autor estão disponíveis para descarregar com o código de fonte.

Kennisgeving met betrekking tot open source-software

Als u de bijbehorende broncode onder GPL, LGPL en andere open source-licenties wilt downloaden, gaat u naar <http://opensource.lge.com>. Alle vermelde licentievoorwaarden, garantiëdisclaimers en kennisgevingen met betrekking tot het auteursrecht, kunt u downloaden met de broncode.

Aviso sobre el software de código abierto

Para obtener el código fuente correspondiente bajo las licencias GPL, LGPL y otras, visite <http://opensource.lge.com>. Todos los términos de licencia, garantías y avisos de derechos de autor están disponibles para descargar con el código fuente.

Opozorilo glede programske opreme z odprto kodo

Za pridobitev programske opreme z odprto kodo v okviru GPL, LGPL in drugih licenc z odprto kodo obiščite <http://opensource.lge.com>. Vsi licenčni pogoji, zavrnitve garancije in obvestila o avtorskih pravicah so na voljo za prenos skupaj z odprto kodo.



Especificação

Specificatie / Προδιαγραφή / Specifikacije

PORTUGUÊS

Requisitos de alimentação	200 - 240 V ~ 50 / 60 Hz
Consumo de energia	12 W
Dimensões (L x A x P)	360 mm x 41,5 mm x 200 mm
Peso Neto (Approx.)	1,4 kg
Barramento Alimentação (USB)	5 V ~ 500 mA

O modelo e as especificações estão sujeitos a alterações sem aviso prévio.

NEDERLANDS

Stroomvereisten	200 - 240 V ~ 50 / 60 Hz
Opgenomen vermogen	12 W
Afmetingen (B x H x D)	Circa 360 mm x 41,5 mm x 200 mm
Netto gewicht (circa)	1,4 kg
USB-busvoeding	5 V ~ 500 mA

Ontwerp en specificaties kunnen zonder voorafgaande kennisgeving worden gewijzigd.

Ελληνικά

Απαιτήσεις τροφοδοσίας	200 - 240 V ~ 50 / 60 Hz
Κατανάλωση ενέργειας	12 W
Διαστάσεις (Π x Υ x Β)	Περίπου 360 mm x 41,5 mm x 200 mm
Καθαρό βάρος (περίπου)	1,4 κιλά
Παροχή ρεύματος διαύλου (USB)	5 V ~ 500 mA

Η σχεδίαση και οι προδιαγραφές υπόκεινται σε μεταβολή χωρίς προειδοποίηση.

SLOVENŠČINA

Zahteve za napajanje	200 - 240 V ~ 50 / 60 Hz
Poraba moči	12 W
Dimenzije (Š x V x G)	Pribl. 360 mm x 41,5 mm x 200 mm
Neto teža (približno)	1,4 kg
Napajanje vodila (USB)	5 V ~ 500 mA

Funkcije in specifikacije se lahko kadarkoli spremenijo.

Substituição da bateria / Vervangen van de batterij / Αντικατάσταση μπαταρίας / Zamenjava baterije

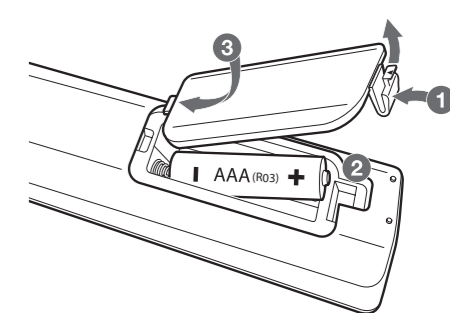

Informação de Segurança

Veiligheidsinformatie / Στοιχεία σχετικά με την ασφάλεια / Varnostne informacije

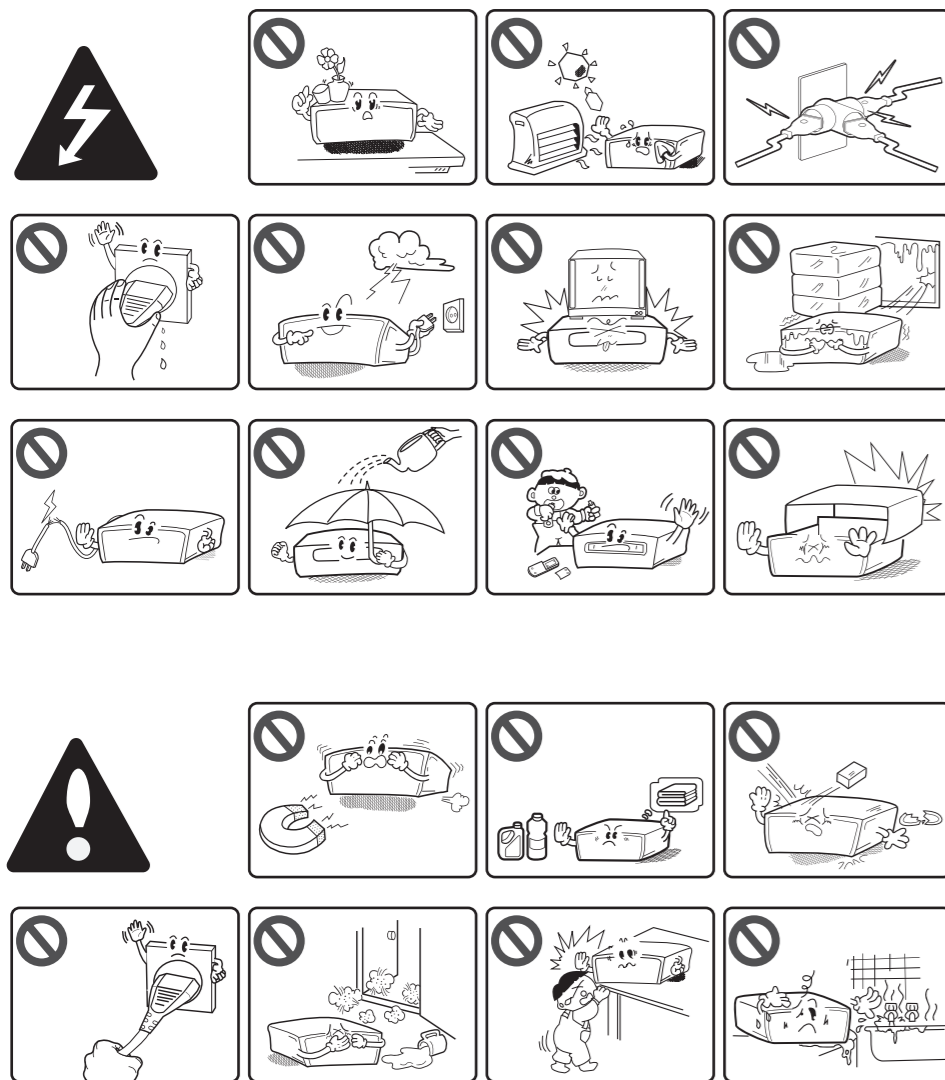

CAUTION RISK OF ELECTRIC SHOCK DO NOT OPEN

CAUTION: TO REDUCE THE RISK OF ELECTRIC SHOCK DO NOT REMOVE COVER (OR BACK) NO USER-SERVICEABLE PARTS INSIDE REFER SERVICING TO QUALIFIED SERVICE PERSONNEL.

This lightning flash with arrowhead symbol within an equilateral triangle is intended to alert the user to the presence of uninsulated dangerous voltage within the product's enclosure that may be of sufficient magnitude to constitute a risk of electric shock to persons.

The exclamation point within an equilateral triangle is intended to alert the user to the presence of important operating and maintenance (servicing) instructions in the literature accompanying the product.

WARNING: TO PREVENT FIRE OR ELECTRIC SHOCK HAZARD, DO NOT EXPOSE THIS PRODUCT TO RAIN OR MOISTURE.

WARNING: Do not install this equipment in a confined space such as a book case or similar unit.

CAUTION: Do not block any ventilation openings. Install in accordance with the manufacturer's instructions. Slots and openings in the cabinet are provided for ventilation and to ensure reliable operation of the product and to protect it from over heating. The openings shall be never be blocked by placing the product on a bed, sofa, rug or other similar surface. This product shall not be placed in a built-in installation such as a bookcase or rack unless proper ventilation is provided or the manufacturer's instruction has been adhered to.

Use of controls, adjustments or the performance of procedures other than those specified herein may result in hazardous radiation exposure.

CAUTION concerning the Power Cord To disconnect power from the mains, pull out the mains cord plug. When installing the product, ensure that the plug is easily accessible.

CAUTION: The apparatus shall not be exposed to water (dripping or splashing) and no objects filled with liquids, such as vases, shall be placed on the apparatus.

This device is equipped with a portable battery or accumulator. Safety way to remove the battery or the battery from the equipment: Remove the old battery or battery pack, follow the steps in reverse order than the assembly. To prevent contamination of the environment and bring on possible threat to human and animal health, the old battery or the battery put it in the appropriate container at designated collection points. Do not dispose of batteries or battery together with other waste. It is recommended that you use local, free reimbursement systems batteries and accumulators. The battery shall not be exposed to excessive heat such as sunshine, fire or the like.

Disposal of your old appliance

1. All electrical and electronic products should be disposed of separately from the municipal waste stream via designated collection facilities appointed by the government or the local authorities.

2. The correct disposal of your old appliance will help prevent potential negative consequences for the environment and human health.

3. For more detailed information about disposal of your old appliance, please contact your city office, waste disposal service or the shop where you purchased the product.

Disposal of waste batteries/accumulators

1. This symbol may be combined with chemical symbols for mercury (Hg), cadmium (Cd) or lead (Pb) if the battery contains more than 0.0005% of mercury, 0.002% of cadmium or 0.004% of lead.

2. All batteries/accumulators should be disposed separately from the municipal waste stream via designated collection facilities appointed by the government or the local authorities.

3. The correct disposal of Your old batteries/accumulators will help to prevent potential negative consequences for the environment, animal and human health.

4. For more detailed information about disposal of Your old batteries/accumulators, please contact Your city office, waste disposal service or the shop where you purchased the product.

LG Electronics hereby declares that this/these product(s) is/are in compliance with the essential requirements and other relevant provisions of Directive 2004/108/EC, 2006/95/EC, 2009/125/EC and 2011/65/EU.

Contact office for compliance of this product: LG Electronics Inc. EU Representative, Krijgsman 1, 1186 DM Amstelveen, The Netherlands

Please note that this is NOT a Customer Service contact point. For Customer Service Information, see Warranty Card or contact the dealer that you purchased this product.

