

# INSTALLATION MANUAL

# AIR-TO-WATER HEAT PUMP

Please read this installation manual completely before installing the product.  
Installation work must be performed in accordance with the national wiring standards by authorized personnel only. Please retain this installation manual for future reference after reading it thoroughly.

**THERMAV™**

Original instruction



MFL68026607  
Rev.15\_052622

Copyright © 2018 - 2022 LG Electronics Inc. All Rights Reserved.

[www.lg.com](http://www.lg.com)

PORTUGUÊS

ENGLISH

MAGYAR

ITALIANO

БЪЛГАРСКИ

ESPAÑOL

SRPSKI

FRANÇAIS

HRVATSKI

DEUTSCH

SLOVENŠČINA

EAHNIKA

DANSK

ČEŠTINA

NEDERLANDS

POLSKI

LIMBA ROMÂNĂ

# TABLE OF CONTENTS

## 5 PREFACE

---

## 6 SAFETY INSTRUCTIONS

---

## 14 INSTALLATION PART

---

## 15 GENERAL INFORMATION

---

- 15 Model Information
- 17 Model name and related information
- 18 Parts and Dimensions
- 24 Control Parts
- 26 Remote Controller
- 27 Typical Installation Example
- 33 Cycle Diagram
- 36 Water cycle

## 39 INSTALLATION

---

- 39 Transporting the Unit
- 40 Installation places
- 41 Seasonal Wind and Cautions in Winter
- 42 Foundation for Installation
- 43 Electrical Wiring
- 53 Wiring of main power supply and equipment capacity
- 54 Water Piping and Water Circuit Connection
- 56 Water Charging
- 56 Pipe Insulation
- 57 Water pump Capacity
- 57 Pressure Drop
- 58 Performance curve
- 59 Water Quality
- 59 Frost protection by antifreeze
- 60 Frost protection by antifreeze valve
- 62 Water Volume and Expansion Vessel Pressure

## 63 ACCESSORIES INSTALLATION

---

- 63 Accessories supported by LG Electronics
- 65 Accessories supported by 3rd party Companies
- 66 Before Installation
- 66 Thermostat
- 70 2nd Circuit
- 75 3rd Party Boiler
- 76 3rd Party Controller
- 77 Meter Interface
- 78 Central Controller
- 79 Remote Controller
- 82 DHW Tank
- 87 DHW Tank Kit
- 89 Solar Thermal Kit
- 91 Dry Contact
- 93 External Controller - Setting up programmable digital input operation
- 94 Remote Temperature Sensor
- 97 Solar pump
- 98 External pump
- 99 Wi-fi Modem
- 100 Energy State
- 101 Digital Input for energy saving (ESS, Smart Grid)
- 102 2Way Valve
- 104 3Way Valve(A)
- 105 3Way Valve(B)

- 106 Electric Heater
- 112 Final check

## 113 CONFIGURATION

---

- 113 DIP Switch Setting

## 123 SERVICE SETTING

---

- 123 How to enter service setting
- 123 Service setting
- 124 Service Contact
- 125 Model Information
- 126 RMC Version Information
- 127 Open Source License

## 128 INSTALLER SETTING

---

- 128 How to enter installer setting
- 129 Installer setting (For 3 Series)
- 131 3 Minutes Delay
- 132 Select Temperature Sensor
- 133 Dry Contact Mode
- 134 Central Control Address
- 135 Pump test run
- 136 Air cooling set temp
- 137 Water cooling set temp
- 138 Air heating set temp
- 139 Water heating set temp
- 140 DHW set temp
- 141 Screed drying
- 143 Heater on temperature
- 145 Water supply off temp. during cooling
- 147 Tank disinfection setting 1, 2
- 148 Tank setting 1
- 149 Tank setting 2
- 151 Heater priority
- 152 DHW time setting
- 153 TH on/off Variable, heating air
- 154 TH on/off Variable, heating water
- 155 TH on/off Variable, cooling air
- 156 TH on/off Variable, cooling water
- 157 Heating temp. setting
- 158 Cooling temp. setting
- 159 Pump setting in heating
- 160 Pump setting. in cooling
- 161 Forced operation
- 162 CN\_CC
- 163 Pump Capacity
- 164 Seasonal auto temp
- 166 Modbus Address
- 167 CN\_EXT
- 168 Anti-freezing Temperature
- 169 Add Zone
- 170 Use External Pump
- 171 3rd Party Boiler
- 172 Meter Interface
- 173 Pump Prerun/Overrun
- 174 Solar Thermal System
- 176 Energy state
- 177 Data logging
- 178 Password Initialization
- 179 Overview settings (For 3 Series)
- 181 Installer setting (For 4 Series)
- 184 Select Temperature Sensor
- 185 Use Heating Tank Heater

|     |                                       |
|-----|---------------------------------------|
| 186 | Mixing Circuit                        |
| 187 | Use External Pump                     |
| 188 | RMC master/slave                      |
| 189 | LG Therma V Configuration             |
| 190 | Forced operation                      |
| 191 | Pump Prerun/Overrun                   |
| 192 | Water Flow Control                    |
| 193 | Energy Monitoring                     |
| 194 | Anti-Freezing Option 1 (For 4 Series) |
| 195 | Password Reset                        |
| 196 | Screed drying                         |
| 198 | Heater on temperature                 |
| 200 | Air heating set temp.                 |
| 201 | Water heating set temp.               |
| 202 | Hysteresis Room Air(Heating)          |
| 203 | Hysteresis Heating Water              |
| 204 | Heating temp. setting                 |
| 205 | Pump setting in heating               |
| 206 | Air cooling set temp.                 |
| 207 | Water cooling set temp.               |
| 208 | Water supply off temp. during cooling |
| 210 | Hysteresis Room Air(Cooling)          |
| 211 | Hysteresis Cooling Water              |
| 212 | Cooling temp. setting                 |
| 213 | Pump setting in cooling               |
| 214 | Seasonal auto temp.                   |
| 217 | Heater priority                       |
| 218 | DHW set temp.                         |
| 219 | Tank disinfection setting 1, 2        |
| 220 | Tank setting 1                        |
| 221 | Tank setting 2                        |
| 223 | DHW time setting                      |
| 224 | Recirculation time                    |
| 225 | Solar Thermal System                  |
| 227 | Pump test run                         |
| 228 | Frost Protection Temp.                |
| 229 | Dry Contact Mode                      |
| 230 | Central Control Address               |
| 231 | CN_CC                                 |
| 232 | LG Therma V Configuration             |
| 233 | Pump frequency setting (RPM)          |
| 234 | Smart Grid(SG)                        |
| 235 | Power Supply Blockage (Smart Grid)    |
| 236 | Energy state                          |
| 237 | Thermostat control type               |
| 238 | Pump operation time                   |
| 239 | IDU operation time                    |
| 240 | Modbus Address                        |
| 241 | Modbus gateway memory map             |
| 244 | CN_EXT                                |
| 245 | 3rd Party Boiler                      |
| 246 | Meter Interface                       |
| 247 | Current flow rate                     |
| 248 | Data logging                          |
| 249 | Overview settings (For 4 Series)      |

## 252 COMMISSIONING

---

|     |   |
|-----|---|
| 252 | Check List before Starting Operation        |
| 253 | Starting Operation                          |
| 254 | Starting Operation flow chart               |
| 254 | Airborne Noise Emission                     |
| 255 | Vacuum & Charge of Refrigerant              |
| 257 | How to drain remaining water in the product |
| 258 | Troubleshooting                             |





# PREFACE

This installation manual is to present information and guide about understanding, installing, and checking **THERMAV..**

Your careful reading before installation is highly appreciated to make no mistake and to prevent potential risks. The manual is divided into nine chapters. These chapters are classified according to installation procedure. See the table below to get summarized information.

| Chapters  | Contents   |
|-----------|--|
| Chapter 1 | <ul style="list-style-type: none"> <li>• Warning and Caution concerned with safety.</li> <li>• This chapter is directly related with human safety. We strongly recommend reading this chapter carefully.</li> </ul>  |
| Chapter 2 | <ul style="list-style-type: none"> <li>• Items Inside product Box</li> <li>• Before starting installation, please make it sure that all parts are found inside the product box.</li> </ul>   |
| Chapter 3 | <ul style="list-style-type: none"> <li>• Fundamental knowledge about <b>THERMAV..</b></li> <li>• Model identification, accessories information, refrigerant and water cycle diagram, parts and dimensions, electrical wiring diagrams, etc.</li> <li>• This chapter is important to understand <b>THERMAV..</b></li> </ul>   |
| Chapter 4 | <ul style="list-style-type: none"> <li>• Installation about the unit.</li> <li>• Installation location, constraints on installation site, etc</li> <li>• Electrical wiring at the unit.</li> <li>• System set-up and configuration.</li> <li>• Information about water pump</li> </ul>                                       |
| Chapter 5 | <ul style="list-style-type: none"> <li>• Information about supported accessories</li> <li>• Specification, Constraints, and wiring are described.</li> <li>• Before purchasing accessories, please find supported specification to buy proper one.</li> </ul>  |
| Chapter 6 | <ul style="list-style-type: none"> <li>• Information about DIP switch setting</li> </ul>   |
| Chapter 7 | <ul style="list-style-type: none"> <li>• check and input service contact</li> <li>• information about model and open source license</li> </ul>   |
| Chapter 8 | <ul style="list-style-type: none"> <li>• Information on the installer setup mode that sets the detailed functions of the remote control</li> <li>• Incorrectly setting the installer setup mode may result in product failure, personal injury, or property loss, so this chapter requires a deeper understanding</li> </ul> |
| Chapter 9 | <ul style="list-style-type: none"> <li>• Check points before starting operation are explained.</li> <li>• Troubleshooting, maintenance, and error code list are presented to correct problems</li> </ul>   |

## SAFETY INSTRUCTIONS

|   |  |   |  |
|---|--|---|--|
|  | <p>Read the precautions in this manual carefully before operating the unit.</p>  |  | <p>This appliance is filled with flammable refrigerant (for R32)</p>   |
|  | <p>This symbol indicates that the Operation Manual should be read carefully.</p> |  | <p>This symbol indicates that a service personnel should be handling this equipment with reference to the Installation Manual.</p> |

The following safety guidelines are intended to prevent unforeseen risks or damage from unsafe or incorrect operation of the appliance. The guidelines are separated into 'WARNING' and 'CAUTION' as described below.

 This symbol is displayed to indicate matters and operations that can cause risk. Read the part with this symbol carefully and follow the instructions in order to avoid risk.

### **WARNING**

This indicates that the failure to follow the instructions can cause serious injury or death.

### **CAUTION**

This indicates that the failure to follow the instructions can cause the minor injury or damage to the product.

## **WARNING**

### Installation

- Do not use a defective or underrated circuit breaker. Use this appliance on a dedicated circuit.
  - There is risk of fire or electric shock.
- For electrical work, contact the dealer, seller, a qualified electrician, or an Authorized Service Center.
  - There is risk of fire or electric shock.

- Always ground the unit.
  - There is risk of fire or electric shock.
- Install the panel and the cover of control box securely.
  - There is risk of fire or electric shock.
- Always install a dedicated circuit and breaker.
  - Improper wiring or installation may cause fire or electric shock
- Use the correctly rated breaker or fuse.
  - There is risk of fire or electric
- Do not modify or extend the power cable.
  - There is risk of fire or electric shock.
- Do not install, remove, or reinstall the unit by yourself (customer).
  - There is risk of fire, electric shock, explosion, or injury
- For antifreeze, always contact the dealer or an authorized service center.
  - Almost the antifreeze is a toxic product.
- For installation, always contact the dealer or an authorized Service Center.
  - There is risk of fire, electric shock, explosion, or injury.
- Do not install the unit on a defective installation stand.
  - It may cause injury, accident, or damage to the unit.
- Be sure the installation area does not deteriorate with age.
  - If the base collapses, the unit could fall with it, causing property damage, unit failure, and personal injury.
- Do not install the water pipe system as Open loop type.
  - It may cause failure of unit.
- Use a vacuum pump or inert (nitrogen) gas when doing leakage test or purging air. Do not compress air or oxygen and do not use flammable gases.
  - There is the risk of death, injury, fire or explosion.
- Make sure the connected condition of connector in product after maintenance.
  - Otherwise, it may cause product damage

- Do not touch leaked refrigerant directly.
  - There is risk of frostbite.
- Compliance with national gas regulations shall be observed.
- Refrigerant tubing shall be protected or enclosed to avoid damage.
- The installation of pipe-work shall be kept to a minimum.
- A brazed, welded, or mechanical connection shall be made before opening the valves to permit refrigerant to flow between the refrigerating system parts. A vacuum valve shall be provided to evacuate the interconnecting pipe and/or any uncharged refrigerating system part.
- Any person who is involved with working on or breaking into a refrigerant circuit should hold a current valid certificate from an industry-accredited assessment authority, which authorizes their competence to handle refrigerants safely in accordance with an industry recognized assessment specification.
- Pipe-work shall be protected from physical damage and shall not be installed in an unventilated space, if that space is smaller than
  - 1) The minimum floor area : 49.4 m<sup>2</sup>
  - 2) The maximum refrigerant charge amount : 2.4 kg
- Do not use means to accelerate the defrosting process or to clean, other than those recommended by the manufacturer.
- Do not pierce or burn.
- Be aware that refrigerants may not contain an odour.
- Dismantling the unit, treatment of the refrigerant oil and eventual parts should be done in accordance with local and national standards.
- Ducts connected to an appliance shall not contain an ignition source.
- Copper in contact with refrigerants shall be oxygen-free or deoxidized, for example Cu-DHP as specified in EN 12735-1 and EN 12735-2.

## Operation

- Take care to ensure that power cable could not be pulled out or damaged during operation.
  - There is risk of fire or electric shock.
- Do not place anything on the power cable.
  - There is risk of fire or electric shock.
- Do not plug or unplug the power supply plug during operation.
  - There is risk of fire or electric shock.
- Do not touch (operate) the unit with wet hands.
  - There is risk of fire or electric shock.
- Do not place a heater or other appliances near the power cable.
  - There is risk of fire or electric shock.
- Do not allow water to run into electric parts.
  - There is risk of fire, failure of the unit, or electric shock.
- Do not store or use flammable gas or combustibles near the unit.
  - There is risk of fire or failure of unit.
- Do not use the unit in a tightly closed space for a long time.
  - It may cause damage to the unit.
- When flammable gas leaks, turn off the gas and open a window for ventilation before turning the unit on.
  - There is risk of explosion or fire.
- If strange sounds or smell or smoke comes from unit, turn the breaker off or disconnect the power supply cable.
  - There is risk of electric shock or fire.
- Stop operation and close the window in storm or hurricane. If possible, remove the unit from the window before the hurricane arrives.
  - There is risk of property damage, failure of unit, or electric shock.
- Do not open the front cover of the unit while operation. (Do not touch the electrostatic filter, if the unit is so equipped.)
  - There is risk of physical injury, electric shock, or unit failure.

- Do not touch any electric part with wet hands. you should be power off before touching electric part.
  - There is risk of electric shock or fire.
- Do not touch refrigerant pipe and water pipe or any internal parts while the unit is operating or immediately after operation.
  - There is risk of burns or frostbite, personal injury.
- If you touch the pipe or internal parts, you should be wear protection or wait time to return to normal temperature.
  - Otherwise , it may cause burns or frostbite, personal injury.
- Turn the main power on 6 hours ago before the product starting operation.
  - Otherwise, it may cause compressor damage.
- Do not touch electric parts for 10 minutes after main power off.
  - There is risk of physical injury, electric shock.
- The inside heater of product may operate during stop mode. It is intended to protect the product.
- Be careful that some part of the control box are hot.
  - There is risk of physical injury or burns.
- When the unit is soaked (flooded or submerged), contact an Authorized Service Center.
  - There is risk of fire or electric shock.
- Be cautious that water could not be poured to the unit directly.
  - There is risk of fire, electric shock, or unit damage.
- Ventilate the unit from time to time when operating it together with a stove, etc.
  - There is risk of fire or electric shock.
- Turn the main power off when cleaning or maintaining the unit.
  - There is risk of electric shock.
- Take care to ensure that nobody could step on or fall onto the unit.
  - This could result in personal injury and unit damage.
- For installation, always contact the dealer or an Authorized Service Center.
  - There is risk of fire, electric shock, explosion, or injury.

- If the unit is not used for long time, we strongly recommend not to switch off the power supply to the unit.
  - There is risk of water freezing.
- The appliance shall be stored in a well-ventilated area where the room size corresponds to the room area as specified for operation.
- The appliance shall be stored in a room without continuously operating open flames (for example an operating gas appliance) and ignition sources (for example an operating electric heater).
- The appliance shall be stored so as to prevent mechanical damage from occurring.
- Servicing shall only be performed as recommended by the equipment manufacturer. Maintenance and repair requiring the assistance of other skilled personnel shall be carried out under the supervision of the person competent in the use of flammable refrigerants.
- When mechanical connectors are reused indoors, sealing parts shall be renewed. When flared joints are reused indoors, the flare part shall be re-fabricated.
- Be aware that refrigerants may not contain an odor.
- Periodic (more than once/year) cleaning of the dust or salt particles stuck on the heat exchangers by using water.
- Keep any required ventilation openings clear of obstruction.

## CAUTION

### Installation

- Always check for gas (refrigerant) leakage after installation or repair of unit.
  - Low refrigerant levels may cause failure of unit.
- Keep level even when installing the unit.
  - To avoid vibration or water leakage.
- Use two or more people to lift and transport the unit.
  - Avoid personal injury.
- Do not install the unit in potentially explosive atmospheres.

- Connect the water for filling or refilling the heating system as specified by EN 1717/EN 61770 to avoid contamination of drinking water by return flow.

## Operation





- Do not use the unit for special purposes, such as preserving foods, works of art, etc.
  - There is risk of damage or loss of property.
- Use a soft cloth to clean. Do not use harsh detergents, solvents, etc.
  - There is risk of fire, electric shock, or damage to the plastic parts of the unit.
- Do not step on or put anything on the unit.
  - There is risk of personal injury and failure of unit.
- Use a firm stool or ladder when cleaning or maintaining the unit.
  - Be careful and avoid personal injury.
- Do not turn on the breaker or power under condition that front panel cabinet, top cover, control box cover are removed or opened.
  - Otherwise it may cause fire, electric shock, explosion or death.
- The appliance shall be disconnected from its power source during service and when replacing parts.
- Means for disconnection must be incorporated in the fixed wiring in accordance with the wiring rules.
- The Installation kit supplied with the appliance are to be used and that old Installation kit should not be reused.
- If the supply cord is damaged, it must be replaced by the manufacturer, its service agent or similarly qualified persons in order to avoid a hazard. Installation work must be performed in accordance with the national wiring standards by authorized personnel only.
- In order to avoid a hazard due to inadvertent resetting of the thermal cut-out, this appliance must not be supplied through an external switching device, such as a timer, or connected to a circuit that is regularly switched on and off by the utility.

- This equipment shall be provided with a supply conductor complying with the national regulation.
- The instructions for service to be done by specialized personnel, mandated by the manufacturer or the authorized representative may be supplied in only one Community language which the specialized personnel understand.
- This appliance is not intended for use by persons (including children) with reduced physical, sensory or mental capabilities or lack of experience and knowledge, unless they have been given supervision or instruction concerning use of the appliance by a person responsible for their safety. Children should be supervised to ensure that they do not play with the appliance.

# INSTALLATION PART

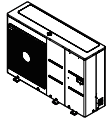
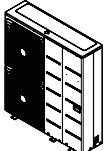
Thank you for choosing LG Electronics Air-to-Water Heat Pump **THERMAV.**

Before starting installation, please make it sure that all parts are found inside the product box.

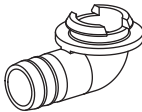
| Item  | Image   |
|---|---|
| Installation Manual   |    |
| Outdoor Unit<br>UN36A Chassis<br>(Product heating capacity :<br>5, 7, 9 kW)       |    |
| Outdoor Unit<br>UN60A Chassis<br>(Product heating capacity :<br>9, 12, 14, 16 kW) |    |
| Remote Controller   |   |
| Remote Controller Cable   |  |
| Damper  |  |
| Drain Cap   |  |
| Drain Nipple  |  |

# GENERAL INFORMATION

With advanced inverter technology, **THERMAV** is suitable for applications like under floor heating, under floor cooling, and hot water generation. By Interfacing to various accessories user can customize the range of the application.

In this chapter, general information of **THERMAV** is presented to identify the installation procedure. Before beginning installation, read this chapter carefully and find helpful information on installation.

## Model Information

### Factory Model Name

| Model    | No. |   |   |    |   |   |   |
|----------|-----|---|---|----|---|---|---|
|          | 1   | 2 | 3 | 4  | 5 | 6 | 7 |
| Monobloc | ZH  | B | W | 09 | 6 | A | 0 |

| No. | Signification  |
|-----|--|
| 1   | Air-to-Water-Heat Pump for R32   |
| 2   | Classification<br>- B : Monobloc   |
| 3   | Model Type<br>- W : Inverter Heat Pump   |
| 4   | Heating Capacity<br>- E.g) 9 kW → '09'   |
| 5   | Electrical ratings<br>- 6 : 1 phase 220-240 V~ 50 Hz<br>- 8 : 3 phase 380-415 V~ 50 Hz |
| 6   | Function<br>- A : General heating heat pump  |
| 7   | Series Number  |

### Buyer Model Name

#### - For 3 Series

| Refrigerant | No. |   |    |   |   |    |   |
|-------------|-----|---|----|---|---|----|---|
|             | 1   | 2 | 3  | 4 | 5 | 7  | 8 |
| R32         | H   | M | 09 | 1 | M | U3 | 3 |

| No. | Signification  |
|-----|--|
| 1   | Air-to-Water-Heat Pump   |
| 2   | Classification<br>- M : Monobloc   |
| 3   | Heating Capacity<br>- E.g) 9 kW → '09'   |
| 4   | Electrical ratings<br>- 6 : 1 phase 220-240 V~ 50 Hz<br>- 8 : 3 phase 380-415 V~ 50 Hz |
| 5   | Leaving Water Combination<br>- M : Middle Temperature                                  |
| 6   | Chassis Name<br>- U3 : UN60A Chassis<br>- U4 : UN36A Chassis                           |
| 7   | Series Number  |

**- For 3 Series**

| Refrigerant | No. |   |    |   |   |   |   |    |   |
|-------------|-----|---|----|---|---|---|---|----|---|
|             | 1   | 2 | 3  | 4 | 5 | 6 | 7 | 8  | 9 |
| R32         | H   | M | 09 | 1 | M | R | S | U3 | 3 |

| No. | Signification  |
|-----|--|
| 1   | Air-to-Water-Heat Pump   |
| 2   | Classification<br>- M : Monobloc   |
| 3   | Heating Capacity<br>- E.g) 9 kW → '09'   |
| 4   | Electrical ratings<br>- 6 : 1 phase 220-240 V~ 50 Hz<br>- 8 : 3 phase 380-415 V~ 50 Hz |
| 5   | Leaving Water Combination<br>- M : Middle Temperature                                  |
| 6   | Refrigerant<br>- R : R32   |
| 7   | Function<br>- S : Silent   |
| 8   | Chassis Name<br>- U3 : UN60A Chassis<br>- U4 : UN36A Chassis                           |
| 9   | Series Number  |

- Additional Information :

Serial number refers to the barcode on the product.

- Max allowable pressure High side :  
4.32 MPa / Low side : 2.4 MPa

[Operating condition]

- Maximum operating temperature of water : 65 °C
- Minimum operating temperature of water : 15 °C
- Maximum inlet water pressure : 0.3 MPa
- Minimum inlet water pressure : 0.03 MPa

**- For 4 Series**

| Refrigerant | No. |   |    |   |   |   |    |   |
|-------------|-----|---|----|---|---|---|----|---|
|             | 1   | 2 | 3  | 4 | 5 | 6 | 7  | 8 |
| R32         | H   | M | 09 | 1 | M | R | U3 | 4 |

| No. | Signification  |
|-----|--|
| 1   | Air-to-Water-Heat Pump   |
| 2   | Classification<br>- M : Monobloc   |
| 3   | Heating Capacity<br>- E.g) 9 kW → '09'   |
| 4   | Electrical ratings<br>- 6 : 1 phase 220-240 V~ 50 Hz<br>- 8 : 3 phase 380-415 V~ 50 Hz |
| 5   | Leaving Water Combination<br>- M : Middle Temperature                                  |
| 6   | Refrigerant<br>- R : R32   |
| 7   | Chassis Name<br>- U3 : UN60A Chassis<br>- U4 : UN36A Chassis                           |
| 8   | Series Number  |

Check the model information based on the buyer model series number.

(e.g., geometry, cycle, etc.)

## Model name and related information

| Model Name |          |              | Capacity (kW)         |                       | Power Source<br>(Unit) |
|------------|----------|--------------|-----------------------|-----------------------|------------------------|
| Chassis    | Phase(Ø) | Capacity(kW) | Heating <sup>1)</sup> | Cooling <sup>2)</sup> |                        |
| UN36A      | 1        | 5            | 5.5                   | 5.5                   | 220-240 V~<br>50 Hz    |
|            |          | 7            | 7                     | 7                     |                        |
|            |          | 9            | 9                     | 9                     |                        |
| UN60A      | 1        | 9            | 9                     | 9                     |                        |
|            |          | 12           | 12                    | 12                    |                        |
|            |          | 14           | 14                    | 14                    |                        |
|            | 3        | 16           | 16                    | 16                    |                        |
|            |          | 12           | 12                    | 12                    |                        |
|            |          | 14           | 14                    | 14                    |                        |
|            |          | 16           | 16                    | 16                    | 380-415 V 3N~<br>50 Hz |

1 : tested under EN14511  
(water temperature 30 °C → 35 °C at outdoor ambient temperature 7 °C / 6 °C)

2 : tested under EN14511  
(water temperature 23 °C → 18 °C at outdoor ambient temperature 35 °C / 24 °C)

\* All appliances were tested at atmospheric pressure.

## Parts and Dimensions

- For 3 Series

UN36A (5, 7, 9 kW)

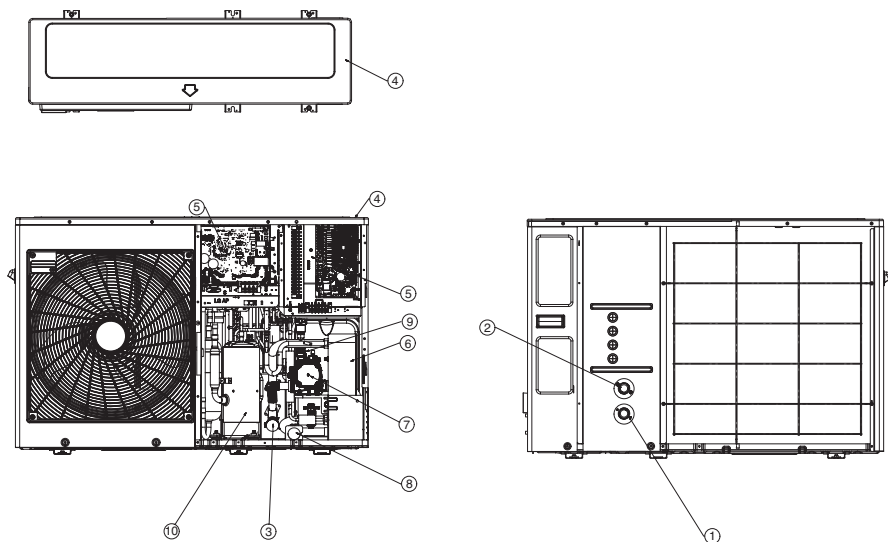

※ The shape may differ depending on the model.

### Description

| No | Name                 | Remarks   |
|----|----------------------|---|
| 1  | Entering water pipe  | Male PT 1 inch  |
| 2  | Leaving water pipe   | Male PT 1 inch  |
| 3  | Strainer             | Filtering and stacking particles inside circulating water |
| 4  | Top cover            | -   |
| 5  | Control Box          | PCB and terminal blocks                                   |
| 6  | Plate Heat Exchanger | Heat exchanger between refrigerant and water              |
| 7  | Water Pump           | Circulating the water                                     |
| 8  | Pressure Gage        | Indicates circulating water pressure                      |
| 9  | Safety valve         | Open at water pressure 3 bar                              |
| 10 | compressor           | -   |

UN60A (9, 12, 14, 16 kW)

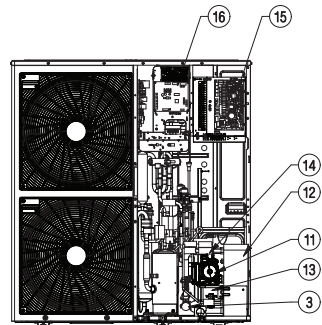
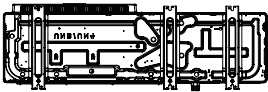
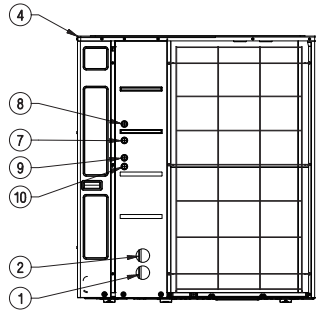
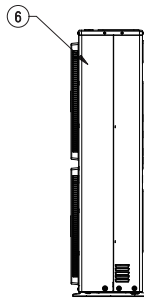
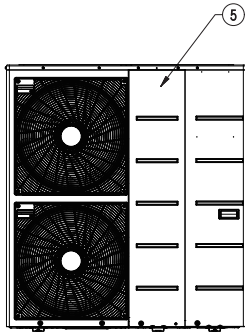
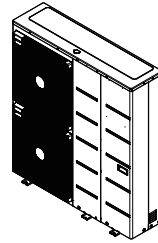

\* The shape may differ depending on the model.

## Description

| No | Name                      | Remarks   |
|----|---------------------------|---|
| 1  | Entering water pipe       | Male PT 1 inch  |
| 2  | Leaving water pipe        | Male PT 1 inch  |
| 3  | Strainer                  | Filtering and stacking particles inside circulating water |
| 4  | Top cover                 | -   |
| 5  | Front Panel               | -   |
| 6  | Side Panel                | -   |
| 7  | Signal A                  | Network Kit cables  |
| 8  | Signal B                  | Network Kit cables  |
| 9  | Signal C                  | -   |
| 10 | Outdoor Entry Power Cable | -   |
| 11 | Water Pump                | Circulating the water                                     |
| 12 | Plate Heat Exchanger      | Heat exchanger between refrigerant and water              |
| 13 | Pressure Gage             | Indicates circulating water pressure                      |
| 14 | Safety valve              | Open at Water pressure 3 bar                              |
| 15 | Heater Control Box        | Heater PCB and terminal blocks                            |
| 16 | Outdoor Control Box       | Outdoor PCB and terminal blocks                           |

- For 4 Series

UN36A (5, 7, 9 kW)

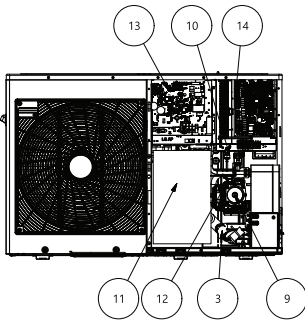
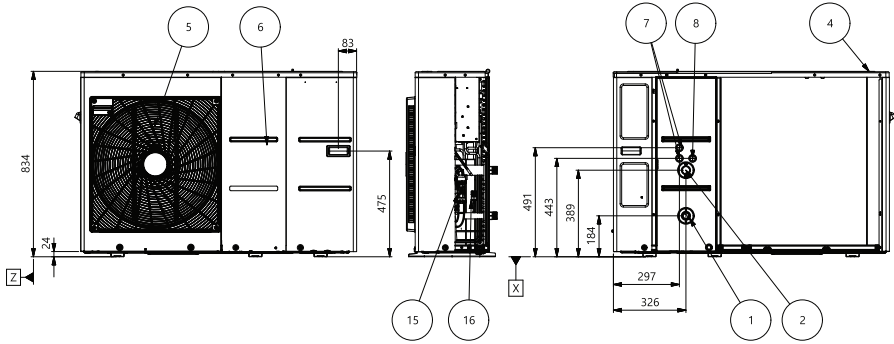
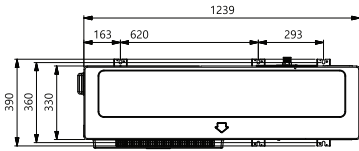

\* The shape may differ depending on the model.

UN60A (12, 14, 16 kW)

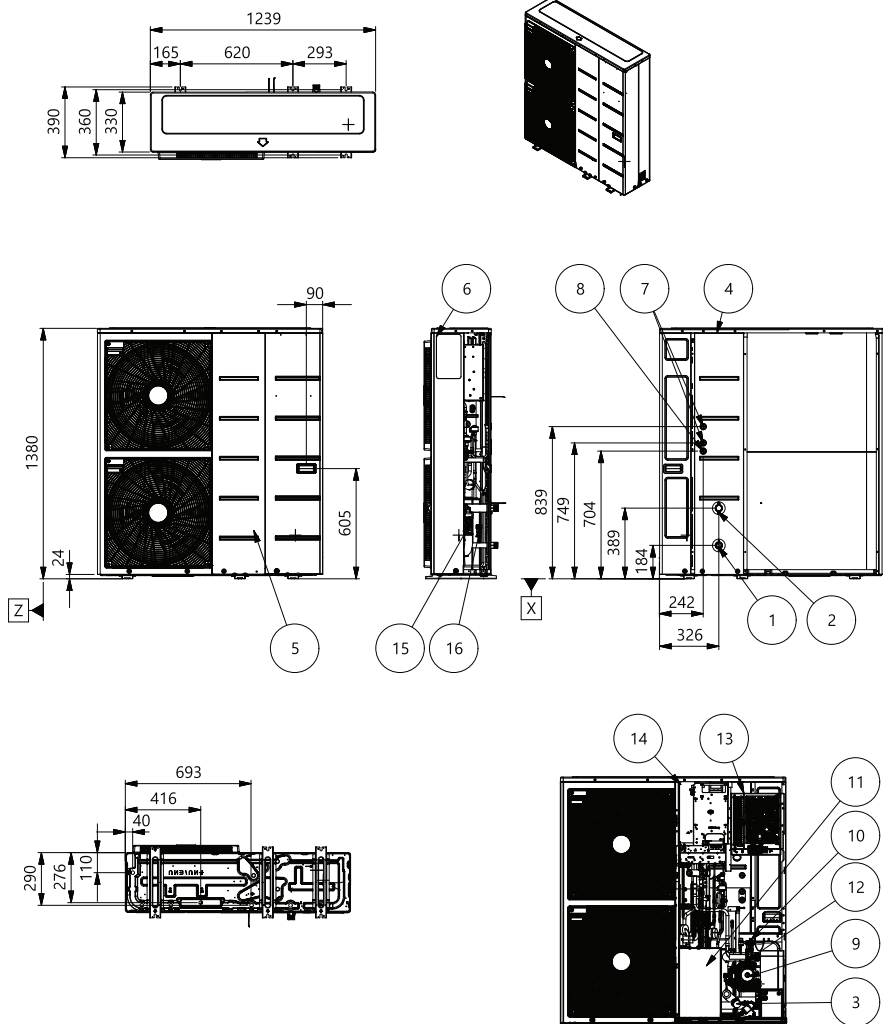

\* The shape may differ depending on the model.

**Description**

| <b>No</b> | <b>Name</b>             | <b>Remarks</b>  |
|-----------|-------------------------|---|
| 1         | Entering water pipe     | Male PT 1 Inch  |
| 2         | Leaving water pipe      | Male PT 1 Inch  |
| 3         | Strainer                | Filtering and stacking porticles inside circulating water |
| 4         | Top cover               | -   |
| 5         | Front Panel             | -   |
| 6         | Side Panel              | -   |
| 7         | Low Voltage             | Communication Cable Hole                                  |
| 8         | UNIT Power              | Power Cable Hole  |
| 9         | Water Pump              | -   |
| 10        | Plate Heat Exchanger    | Heat exchange between refrigerant and water               |
| 11        | Compressor shield panel | -   |
| 12        | Safety valve            | Open at water pressure 3 bar                              |
| 13        | Indoor Control Box      | PCB and terminal blocks                                   |
| 14        | Outdoor Control Box     | PCB and terminal blocks                                   |
| 15        | Flow sensor             | SIKA VVX20 5-80 LPM                                       |
| 16        | Pressure Sensor         | SENSATA 2HMP3-05W 02-MPa                                  |

## Control Parts

- For 3 Series

### Control box before structural change (Until August, 2020)

UN36A (5, 7, 9 kW)

UN60A (9, 12, 14, 16 kW)

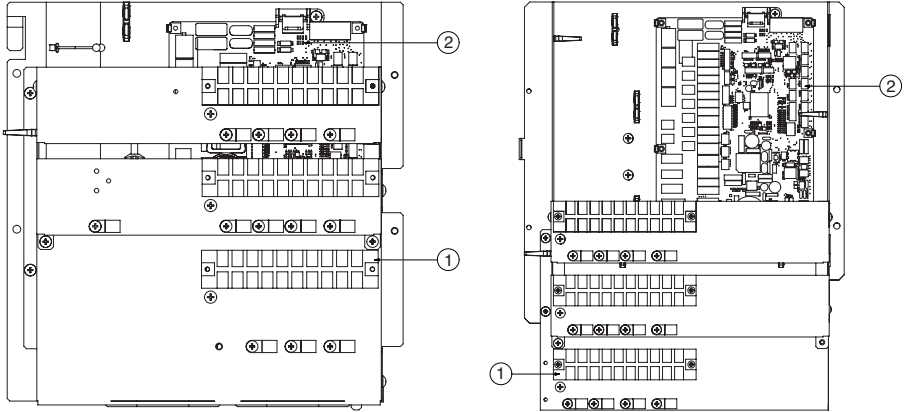

### Control box after structural change (From September, 2020)

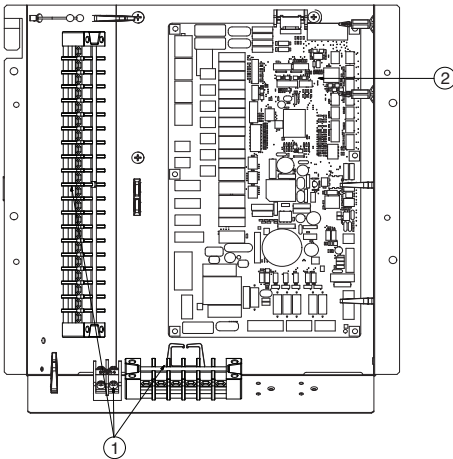

※ The shape may differ depending on the model. Refer to “Exploded View” in SVC Manual.

#### Description

| No | Name            | Remark   |
|----|-----------------|--|
| 1  | Terminal blocks | The terminal blocks allow easy connection of field wiring                |
| 2  | Main PCB        | The main PCB(Printed Circuit Board) controls the functioning of the unit |

- For 4 Series

## Control box

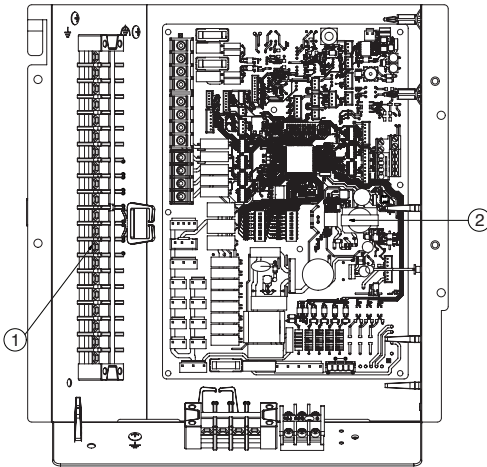

※ The shape may differ depending on the model. Refer to “Exploded View” in SVC Manual.

### Description

| No | Name            | Remark   |
|----|-----------------|--|
| 1  | Terminal blocks | The terminal blocks allow easy connection of field wiring                |
| 2  | Main PCB        | The main PCB(Printed Circuit Board) controls the functioning of the unit |

## Remote Controller

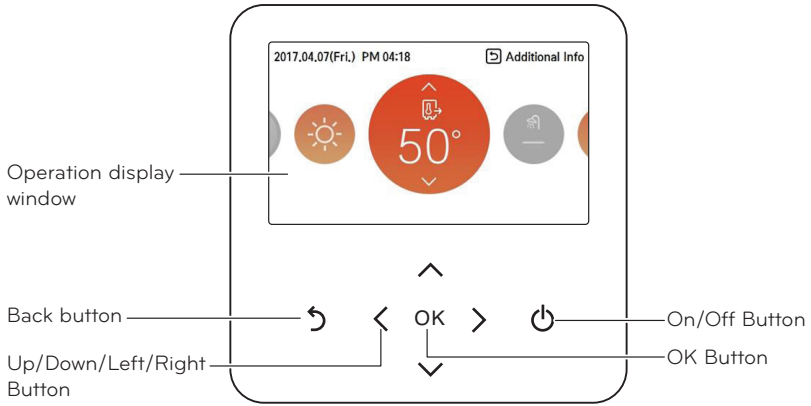

|                           |   |
|---------------------------|---|
| Operation display window  | Operation and Settings status display                             |
| Back button               | When you move to the previous stage from the menu's setting stage |
| Up/down/left/right button | When you change the menu's setting value                          |
| OK button                 | When you save the menu's setting value                            |
| On/Off button             | When you turn ON/OFF the Unit                                     |

## Typical Installation Example

### ⚠ CAUTION

If **THERMAV** is installed with pre-existing boiler, the boiler and **THERMAV** should not be operated together. If entering water temperature of **THERMAV** is above 55 °C, the system will stop operation to prevent mechanical damage of the product. For detailed electric wiring and water piping, please contact authorized installer.

Some installation scenes are presented for example. As these scenes are conceptual figures, installer should optimize the installation scene according to the installation conditions. Note that buffer tank should be installed.

### CASE 1: Connecting Heat Emitters for Heating and Cooling

(Under floor loop, Fan Coil Unit, and Radiator)

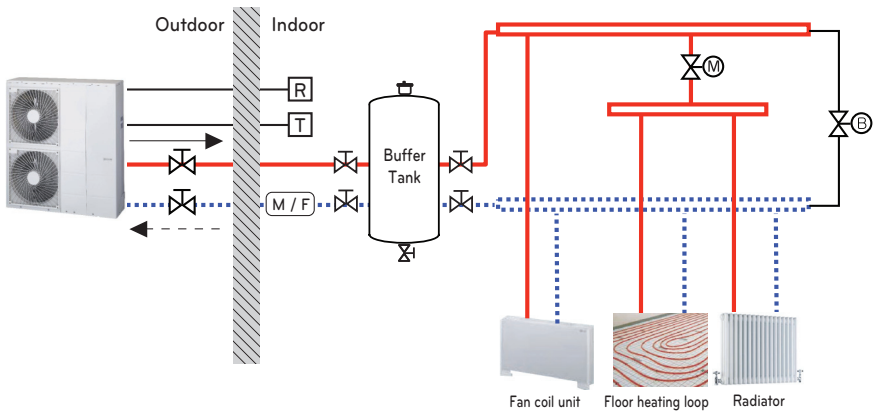

### NOTE

- Room thermostat
  - Type of thermostat and specification should be complied with chapter 4 and chapter 7 of **THERMAV** installation manual.
- 2way valve
  - It is important to install 2way valve to prevent dew condensation on the floor and radiator while cooling mode.
  - Type of 2way control valve and specification should be complied with chapter 4 and chapter 7 of **THERMAV** installation manual.
  - 2way valve should be installed at the supply side of the collector.
- By-pass valve
  - To secure enough water flow rate, by-pass valve should be installed at the collector.
  - By-pass valve should guarantee minimum water flow rate in any case. Minimum water flow rate is described in water pump characteristics curve.

— High Temperature

..... Low Temperature

(M/F) Magnetic Filter (Mandatory)

(T) Room Thermostat  
(Field supply)

(M) 2way valve  
(Field supply)

⊗ Shut-off valve

(B) By-pass valve(Field supply)

(R) Remote controller

CASE 2: Connecting DHW Tank

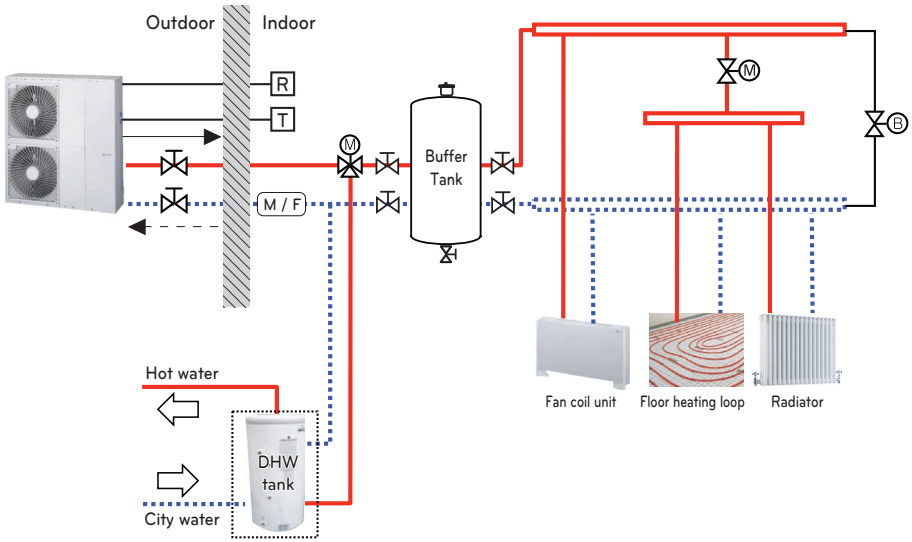

NOTE

- DHW tank
  - It should be equipped with internal electric heater to generate sufficient heat energy in very cold season.
  - DHW : Domestic Hot Water
- 3way valve
  - Type of 3way valve and specification should be complied with chapter 4 and chapter 7 of **THERMAV** installation manual.

|                             |                               |                           |
|-----------------------------|-------------------------------|---------------------------|
| High Temperature            | Room Thermostat(Field supply) | Remote controller         |
| Low Temperature             | 2way valve (Field supply)     | 3way valve (Field supply) |
| Shut-off valve              | By-pass valve(Field supply)   |                           |
| Magnetic Filter (Mandatory) |                               |                           |

### CASE 3: Connecting Solar thermal system

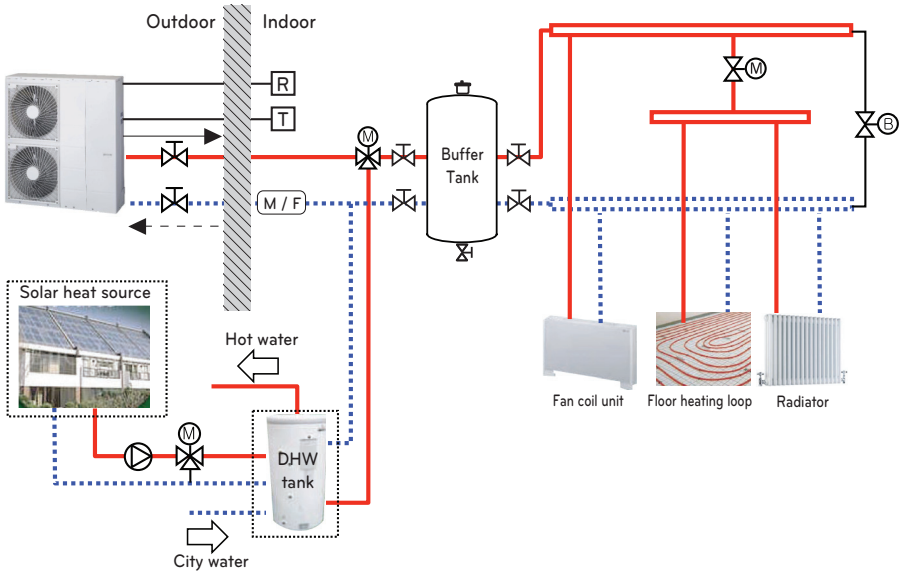

#### NOTE

- DHW tank
  - It should be equipped with internal electric heater to generate sufficient heat energy in very cold season.
  - DHW : Domestic Hot Water
- Pump
  - Maximum power consumption of pump should be less than 0.25 kW.

— High Temperature

... Low Temperature

⊘ Shut-off valve

(M/F) Magnetic Filter (Mandatory)

⊠ Room Thermostat(Field supply)

⊙ 2way valve  
(Field supply)

⊙ By-pass valve(Field supply)

⊠ Remote controller

⊙ 3way valve  
(Field supply)

⊙ Pump(Field supply)

CASE 4: Connecting 2<sup>nd</sup> Circuit

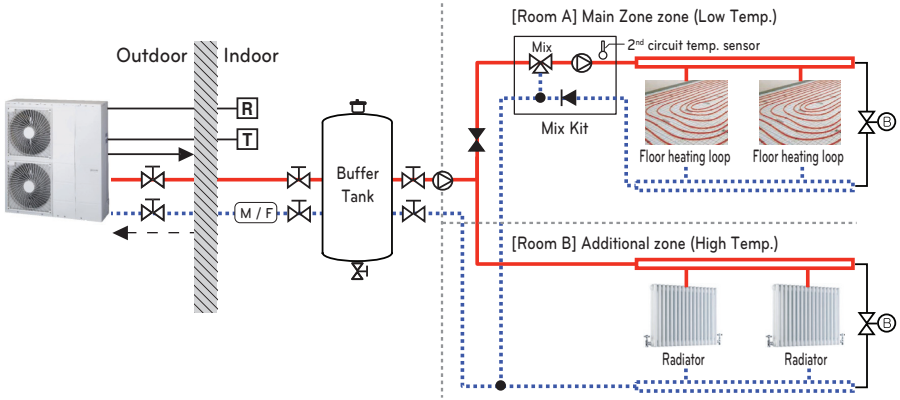

NOTE

- Mix Kit
  - You can install it when you want to set the temperature of two rooms individually
  - When heating, Main Zone can not be higher than Add Zone.
  - When cooling, Main Zone can not be lower than Add Zone.
  - The types and specifications of the Mix Kit are to comply with Chapters 4 and 7 of the **THERMAV** Installation Manual.

|  |  |  |                                |  |                             |
|--|--|--|--------------------------------|--|-----------------------------|
|  | High Temperature                         |  | Room Thermostat (Field supply) |  | 3way valve (Field supply)   |
|  | Low Temperature                          |  | 2way valve (Field supply)      |  | By-pass valve(Field supply) |
|  | Shut-off valve                           |  | By-pass valve(Field supply)    |  | Pump(Field supply)          |
|  | Magnetic Filter (Mandatory)              |  | Air vent (Field supply)        |  | Mix Kit (Field supply)      |
|  | Pressure Regulation valve (Field supply) |  |                                |  |                             |

### CASE 5: Connecting 3<sup>rd</sup> Party

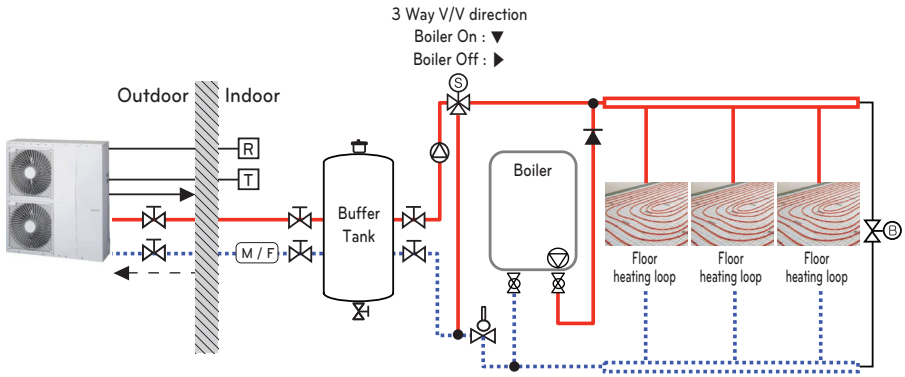

#### NOTE

- DHW tank
  - 3rd Party Boiler
  - You can control the boiler automatically and manually by comparing the outside temperature and the set temperature.
- 3way valve
  - It is a valve for DHW use.
  - Not installed when installing Buffer Tank
  - Type of 3way valve and specification should be complied with chapter 4 and chapter 7 of installation manual.

|  |                             |  |                               |  |                           |
|--|-----------------------------|--|-------------------------------|--|---------------------------|
|  | High Temperature            |  | Room Thermostat(Field supply) |  | 3way valve (Field supply) |
|  | Low Temperature             |  | 2way valve (Field supply)     |  | Pump(Field supply)        |
|  | Shut-off valve              |  | By-pass valve(Field supply)   |  | AquaStat V/V              |
|  | Magnetic Filter (Mandatory) |  | Air vent (Field supply)       |  |                           |
|  | Reverse check valve         |  |                               |  |                           |

**CASE 6 : Connecting backup heater**

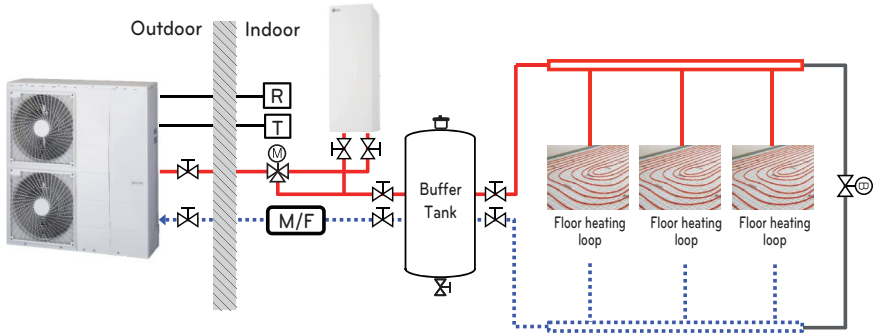

**NOTE**

- Backup heater(Accessory)
  - You can retain sufficient capacity even though ambient temperature will be decreased in winter.

— High Temperature

..... Low Temperature

**M/F** Magnetic Filter (Mandatory)

**T** Room Thermostat (Field supply)

**M** 3way valve (Field supply)

**R** Remote controller

**⊗** Shut-off valve

**⊕** By-pass valve (Field supply)



UN60A (1Ø : 9 kW)

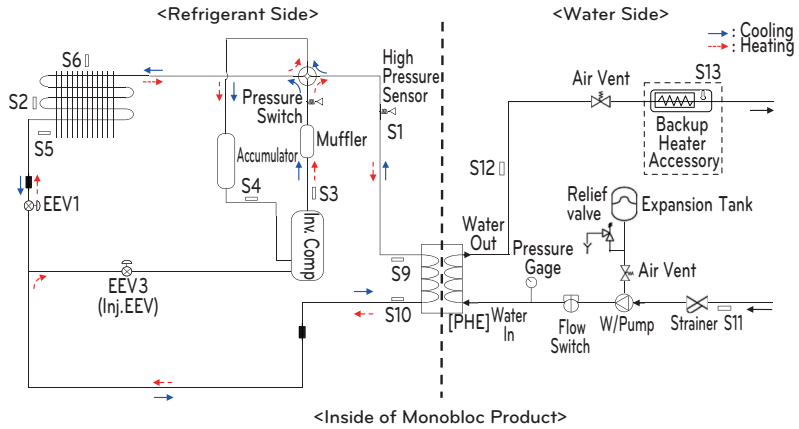

Description

| Category    | Symbol | Meaning                                       | PCB Connector |
|-------------|--------|---|---------------|
| Indoor Unit | S1     | High pressure sensor                          | CN_H_PRESS    |
|             | S2     | Condenser middle temperature sensor           | CN_MID        |
|             | S3     | Compressor-discharge pipe temperature sensor  | CN_DISCHA     |
|             | S4     | Compressor-suction pipe temperature sensor    | CN_SUCTION    |
|             | S5     | Condenser temperature sensor                  | CN_C_PIPE     |
|             | S6     | Outdoor air temperature sensor                | CN_AIR        |
|             | S7     | Inlet IHEX temperature sensor                 | CN_VI_IN      |
|             | S8     | Outlet IHEX temperature sensor                | CN_VI_OUT     |
|             | S9     | PHEX gas temp. sensor                         | CN_PIPE_OUT   |
|             | S10    | PHEX liquid temp. sensor                      | CN_PIPE_IN    |
| Water Side  | S11    | Entering water temperature sensor             | CN_TH3        |
|             | S12    | Leaving water temperature sensor              |               |
|             | S13    | Electric backup heater outlet (Accessory kit) |               |

-S9, S10, S5 : Description is expressed based on Cooling mode.

- For 4 Series

UN36A (5, 7, 9 kW)

UN60A (12, 14, 16 kW)

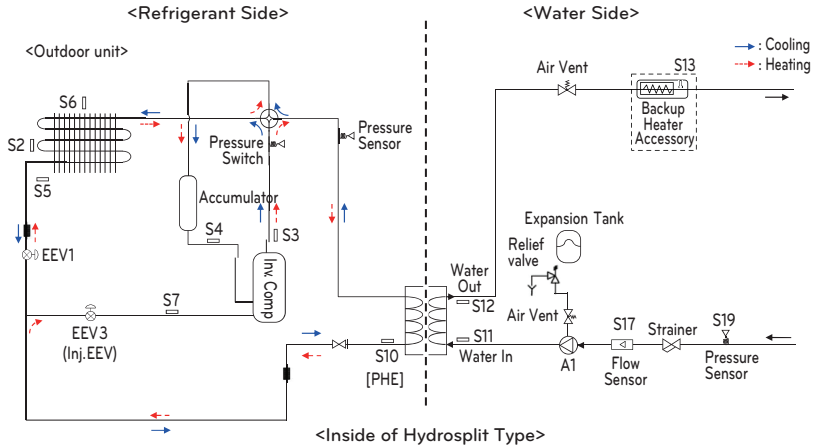

Description

| Category         | Symbol   | Meaning  | PCB Connector           |
|------------------|--|--|-------------------------|
| Refrigerant side | S1   | PHEX liquid temperature sensor                 | CN_PIPE_IN              |
|                  | S2   | Outdoor-HEX middle temperature sensor          | CN_MID                  |
|                  | S3   | Compressor-discharge pipe temperature sensor   | CN_DISCHARGE            |
|                  | S4   | Compressor-suction pipe temperature sensor     | CN_SUCTION              |
|                  | S5   | Outdoor-HEX temperature sensor                 | CN_C_PIPE               |
|                  | S6   | Outdoor air temperature sensor                 | CN_AIR                  |
|                  | S7   | Compressor-injection pipe temperature sensor   | CN_VI_IN                |
|                  | EEV1   | Electronic Expansion Valve (Heating/Cooling)   | CN_EEV1                 |
|                  | EEV2   | Electronic Expansion Valve (Injection)         | CN_EEV_MAIN             |
| Water Side       | S12  | Outlet water temperature sensor                | CN_WATER_OUT            |
|                  | S11  | Inlet water temperature sensor                 | CN_WATER_IN             |
|                  | S13  | Backup heater outlet sensor                    | CN_TH3                  |
|                  | S17  | Flow sensor                                    | CN_F_SENSOR             |
|                  | S19  | Water pressure sensor                          | CN_H2O_PRESS            |
|                  | A1   | Main Water Pump                                | CN_PUMP_A1<br>CN_MOTOR1 |
|                  | A8   | Electric backup heater(1Ø, Optional accessory) | CN_HEATER_PCB           |
| A9               | Electric backup heater(3Ø, Optional accessory) | HEATER1  |                         |

# Water cycle

- For 3 Series

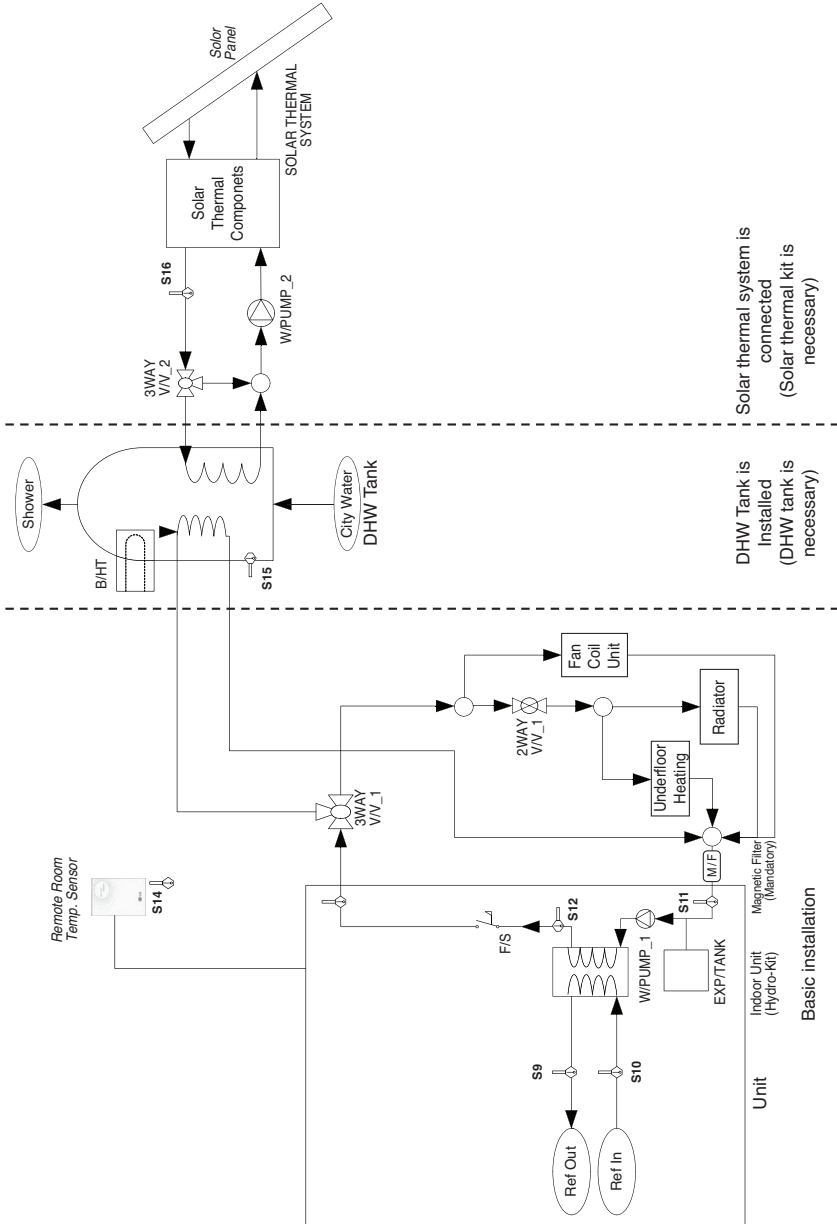

Solar thermal system is connected (Solar thermal kit is necessary)

DHW Tank is installed (DHW tank is necessary)

- For 4 Series

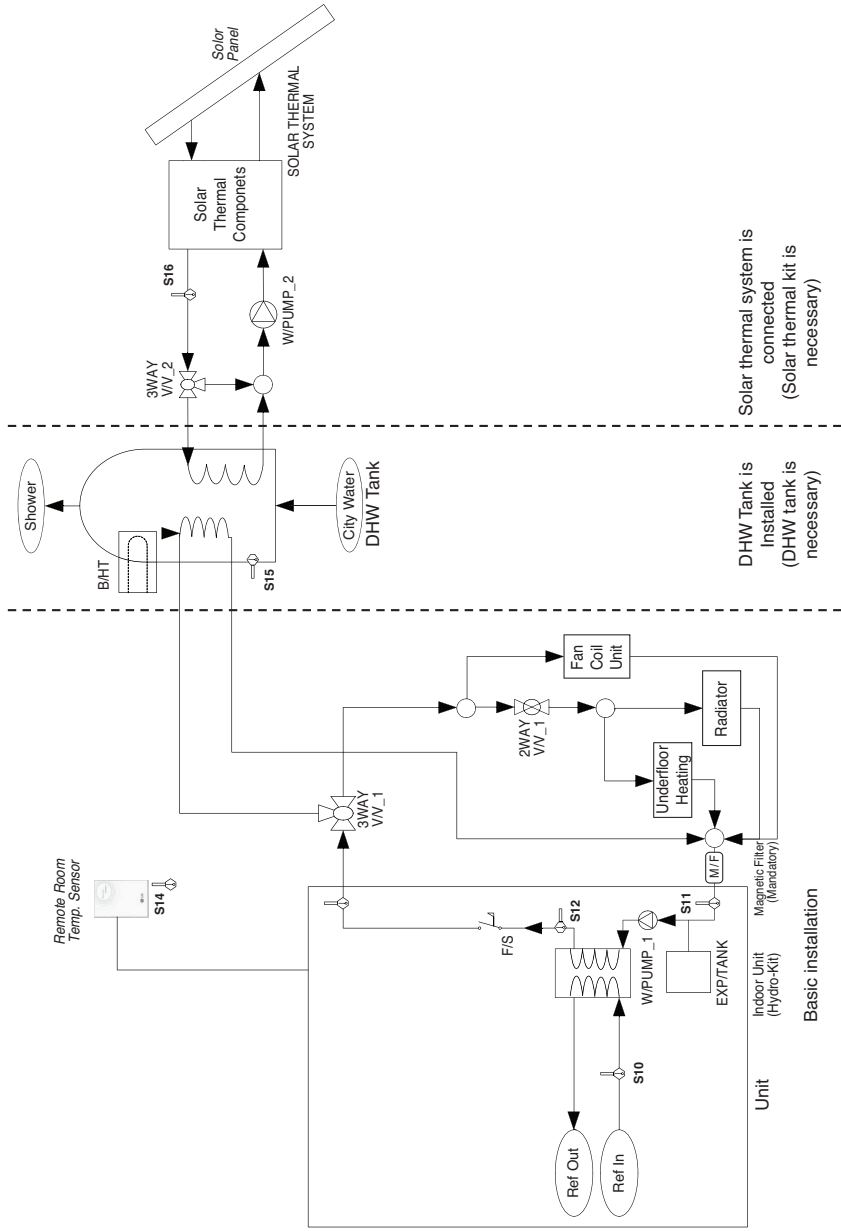

Solar thermal system is connected (Solar thermal kit is necessary)

DHW Tank is installed (DHW tank is necessary)

Basic installation

## Description

| Category             | Symbol  | Meaning  | PCB Connector  | Remarks  |
|----------------------|---|--|--|--|
| Unit                 | S9  | Refrigerant temperature sensor (Gas side)  | CN_PIPE_OUT  | - Meaning is expressed based on Cooling mode.  |
|                      | S10   | Refrigerant temperature sensor (Liquid side)   | CN_PIPE_IN   |  |
|                      | S11   | Water temperature sensor (Water In)  | Water_IN   |  |
|                      | S12   | Water temperature sensor (Water Out)   | Water_OUT  |  |
|                      | F/S   | Flow Switch  | CN_FLOW1   |  |
|                      | E/HT  | Electric Heater  | CN_E/HEAT(A)<br>CN_E/HEAT(B)   | - Optional accessory (sold separately)<br>- Model : HA**1A E1<br>- Heating capacity is divided into two level : partial capacity by E/HEAT(A) and full capacity by E/HEAT(A) + E/HEAT(B).<br>- Operating power(220-240 V~ 50 Hz) of E/HEAT(A) and E/HEAT(B) are supplied by external power source via relay connector and ELB. |
|                      | W_PUMP1   | Internal Water Pump  | CN_MOTOR1  | - Water Pump is connected at CN_MOTOR1   |
|                      | EXP/TANK  | Expansion Tank   | (no connector)   | - Absorb volume change of heated water,  |
|                      | S14   | Remote Air temperature sensor  | CN_ROOM  | - Optional accessory (sold separately)<br>- Model : PQRSTA0  |
|                      | CTR/PNL   | Remote Controller  | CN_REMO  |  |
| Water Heating        | 2WAY V/V_1  | To control water flow for Fan Coil Unit  | CN_2WAY(A)   | - 3 <sup>rd</sup> party accessory and Field installation (sold separately)<br>- 2 wire NO or NC type 2way valve is supported.  |
|                      | M / F   | Magnetic Filter  | (No connector)   | - 3 <sup>rd</sup> party accessory and Field installation (sold separately)<br>- It is Mandatory to install an additional filter on the heating water circuit.  |
|                      | W/TANK  | DHW Tank   | (no connector)   | - 3 <sup>rd</sup> party accessory and Field installation (sold separately)<br>- Generating and storing DHW by AWHP or built-in electric heater   |
|                      | B/HT  | Booster heater(in DHW tank)  | CN_B/HEAT(A)   | - 3 <sup>rd</sup> party accessory and Field installation (usually built-in at W/TANK)<br>- Supplying additional water heating capacity.  |
|                      | 3WAY V/V_1  | - Flow direction for water which is leaving from unit.<br>- Flow direction switching between underfloor and water tank                                 | CN_3WAY(A)   | - 3 <sup>rd</sup> party accessory and Field installation (sold separately)<br>- SPDT type 3way valve is supported.   |
|                      | CITY WATER  | Water to be heated by Indoor unit and B/HT of W/TANK   | (no connector)   | - Field installation   |
| Solar Heating        | SHOWER  | Water supplied to end-user   | (no connector)   | - Field installation   |
|                      | S15   | W/TANK water temperature sensor  | CN_TH4   | - S15 and S16 are connected at 4 pin type connector CN_TH4.<br>- S15 is a part of DHW tank kit.(Model : PHLTB)<br>- S16 is a part of solar thermal kit (Model:PHLLA)   |
|                      | S16   | Solar-heated water temperature sensor  |  |  |
|                      | 3WAY V/V_2  | - Flow control for water which is heated and circulated by SOLAR THERMAL SYSTEM.<br>- Flow direction switching between SOLAR THERMAL SYSTEM and W/TANK | CN_3WAY(B)   | - 3 <sup>rd</sup> party accessory and Field installation (sold separately)<br>- SPDT type 3way valve is supported.   |
|                      | W_PUMP/2  | External Water Pump  | CN_W/PUMP(B)   | - 3 <sup>rd</sup> party accessory and Field installation (sold separately)<br>- If water pump of SOLAR THERMAL SYSTEM is incapable of circulation,external water pump can be used.   |
| SOLAR THERMAL SYSTEM | - This system can include following components : Solar panel, Sensors, Thermostats, Interim heat exchanger, Water pump, etc.<br>- To utilized hot water heated by SOLAR THERMAL SYSTEM, end-user must by LG AWHP Solar-Kit. | (no connector)   | - 3 <sup>rd</sup> party accessory and Field installation (sold separately) |  |

# INSTALLATION

## Transporting the Unit

- When carrying the suspended unit, pass the ropes between legs of base panel under the unit.
- Always lift the unit with ropes attached at four points so that impact is not applied to the unit.
- Attach the ropes to the unit at an angle  $\text{\textcircled{A}}$  of  $40^\circ$  or less.
- Use only accessories and parts which are of the designated specification when installing.
- Forklift trucks are not available without a palette.
- Be careful not to damage the product when moving the forklift.

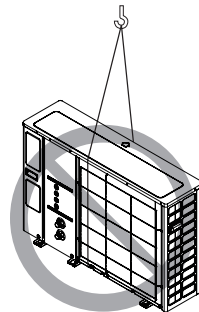
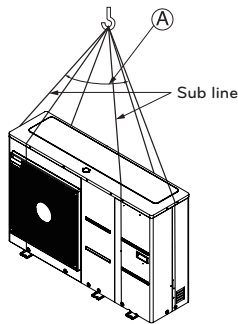

$\text{\textcircled{A}}$   $40^\circ$  or less

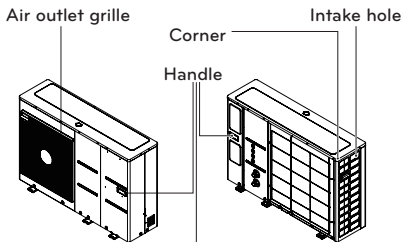

Always hold the unit by the corners, as holding it by the side intake holes on the casing may cause them to deform.

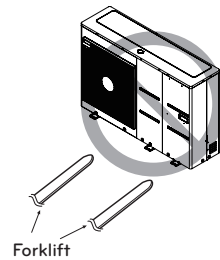

## Installation places

- If an awning is built over the unit to prevent direct sunlight or rain exposure, make sure that heat radiation from the condenser is not restricted.
- Ensure that the spaces indicated by arrows around front, back and side of the unit.
- Do not place animals and plants in the path of the warm air.
- Take the Unit weight into account and select a place where noise and vibration are minimum.
- Select a place so that the warm air and noise from the air conditioner do not disturb neighbors.
- Place that can sufficiently endure the weight and vibration of the outdoor unit and where even installation is possible
- Place that has no direct influence of snow or rain
- Place with no danger of snowfall or icicle drop
- Place without weak floor or base such as decrepit part of the building or with a lot of snow accumulation

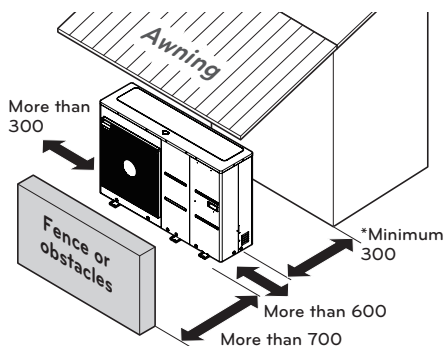

\* : Please secure the space to Maintain the shut-off valve and strainer.

Unit : mm

## CAUTION

Be very careful while carrying the product.

- Do not have only one person carry product if it is more than 20 kg.
- PP bands are used to pack some products. Do not use them as a mean for transportation because they are dangerous.
- Do not touch heat exchanger fins with your bare hands. Otherwise you may get a cut in your hands.
- Tear plastic packaging bag and scrap it so that children cannot play with it. Otherwise plastic packaging bag may suffocate children to death.
- When carrying in Unit, be sure to support it at four points. Carrying in and lifting with 3-point support may make Outdoor Unit unstable, resulting in a fall.
- Use 2 belts of at least 8 m long.
- Place extra cloth or boards in the locations where the casing comes in contact with the sling to prevent damage.
- Hoist the unit making sure it is being lifted at its center of gravity.

## Installation at Seaside

### ⚠ CAUTION

- Unit should not be installed in areas where corrosive gases, such as acid or alkaline gas, are produced.
- Do not install the unit where it could be exposed to sea wind (salty wind) directly. It can result corrosion on the unit. Corrosion, particularly on the condenser and evaporator fins, could cause unit malfunction or inefficient performance.
- If unit is installed close to the seaside, it should avoid direct exposure to the sea wind. Otherwise it needs additional anticorrosion treatment on the heat exchanger.

### Selecting the location

- If the unit is to be installed close to the seaside, direct exposure to the sea wind should be avoided. Install the unit on the opposite side of the sea wind direction.

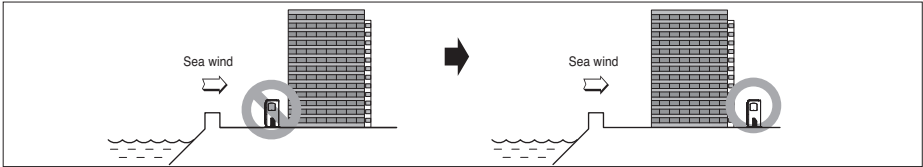

- In case, to install the unit on the seaside, set up a windbreak not to be exposed to the sea wind.

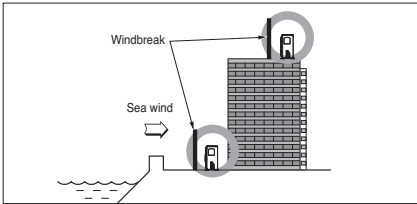

- It should be strong enough like concrete to prevent the sea wind from the sea.
- The height and width should be more than 150 % of the unit.
- It should be keep more than 700 mm of space between unit and the windbreak for easy air flow.

- Select a well-drained place.

- If you can't meet above guide line in the seaside installation, please contact your supplier for the additional anticorrosion treatment.
- Periodic ( more than once/year ) cleaning of the dust or salt particles stuck on the heat exchanger by using water

## Seasonal Wind and Cautions in Winter

- Sufficient measures are required in a snow area or severe cold area in winter so that unit can be operated well.
- Get ready for seasonal wind or snow in winter even in other areas.
- Install a suction and discharge duct not to let in snow or rain.
- Install the unit not to come in contact with snow directly. If snow piles up and freezes on the air suction hole, the system may malfunction. If it is installed at snowy area, attach the hood to the system.
- Install the unit at the higher installation console by 500 mm than the average snowfall (annual average snowfall) if it is installed at the area with much snowfall.
- Where snow accumulated on the upper part of the unit by more than 100 mm, always remove snow for operation.
  - The height of H frame must be more than 2 times the snowfall and its width shall not exceed the width of the unit. (If width of the frame is wider than that of the unit, snow may accumulate.)
  - Don't install the suction hole and discharge hole of the unit facing the seasonal wind.

## Foundation for Installation

- Check the strength and level of the installation ground so that the unit will not cause any operating vibration or noise after installation.
- Fix the unit securely by means of the foundation bolts. (Prepare 6sets of M12 foundation bolts, nuts and washers each which are available on the market.)
- It is best to screw in the foundation bolts until their length are 20 mm from the foundation surface.
- When installing the unit on the ground, install a separate pedestal with enough height to install the drain nipple.

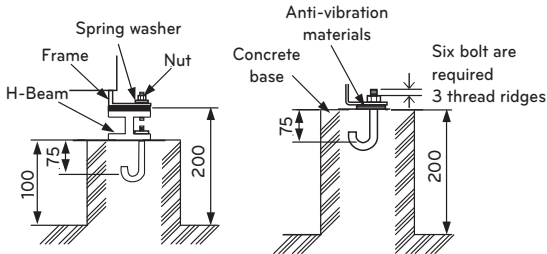
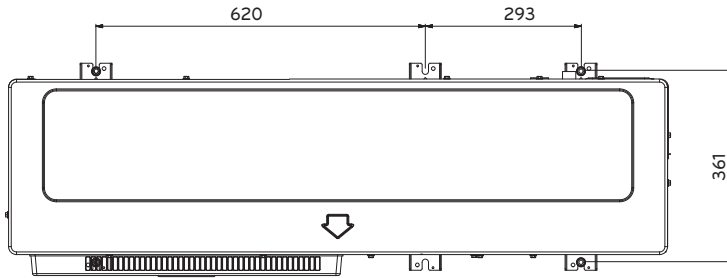

[Unit:mm]

Foundation bolt executing method

## ! WARNING

- Be sure to remove the Pallet(Wood Support) of the bottom side of the unit Base Pan before fixing the bolt. It may cause the unstable state of the unit settlement, and may cause freezing of the heat exchanger resulting in abnormal operations.
- Be sure to remove the Pallet(Wood Support) of the bottom side of the unit before welding. Not removing Pallet(Wood Support) causes hazard of fire during welding.

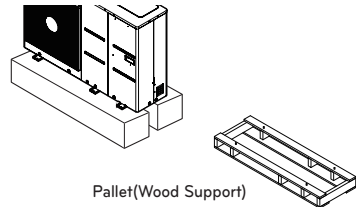

Pallet(Wood Support)  
- Remove before Installation

## Electrical Wiring

- Follow ordinance of your governmental organization for technical standard related to electrical equipment, wiring regulations and guidance of each electric power company.

### WARNING

- Be sure to have authorized electrical engineers do the electric work using special circuits in accordance with regulations and this installation manual. If power supply circuit has a lack of capacity or electric work deficiency, it may cause an electric shock or fire.
- Install the Unit transmission line away from the power source wiring so that it is not affected by electric noise from the power source. (Do not run it through the same conduit.)
- Be sure to provide designated grounding work to Unit.

### CAUTION

- Be sure to correct the unit to earth. Do not connect earth line to any gas pipe, liquid pipe, lightning rod or telephone earth line. If earth is incomplete, it may cause an electric shock.
- Give some allowance to wiring for electrical part box of Units, because the box is sometimes removed at the time of service work.
- Never connect the main power source to terminal block of transmission line. If connected, electrical parts will be burnt out.
- Only the transmission line specified should be connected to the terminal block for Unit transmission.

### CAUTION

- This product have reversed phase protection detector that only works when the power is turned on. If there exists black out or the power goes on and off which the product is operating, attach a reversed phase protection circuit locally. running the product in reversed phase may break the compressor and other parts.
- Use the 2-core shield cables for communication lines. Never use them together with power lines.
- The conductive shielding layer of cable should be grounded to the metal part of both units.
- Never use multi-core cable
- As this unit is equipped with an inverter, to install a phase leading capacitor not only will deteriorate power factor improvement effect, but also may cause capacitor abnormal heating. Therefore, never install a phase leading capacitor.
- Make sure that the power unbalance ratio is not greater than 2 %. If it is greater, the unit's lifespan will be reduced.
- Introducing with a missing N-phase or with a mistaken N-phase will break the equipment

## ! CAUTION

The power cable connected to the unit should be complied with IEC 60245 or HD 22.4 S4 (This equipment shall be provided with a cable set complying with the national regulation. Pipes and wires should be purchased separately for installation of the product.)

Select a circuit breaker and power cable suitable for the current specification.

| Factory Model Name | Buyer Model Name | Phase[Ø] | Capacity [kW] | ELCB |
|--------------------|------------------|----------|---------------|------|
| ZHBW056A0          | HM051M U43       | 1        | 5             | 16 A |
| ZHBW076A0          | HM071M U43       |          | 7             | 20 A |
| ZHBW096A0          | HM091M U43       |          | 9             | 25 A |
| ZHBW096S0          | HM091MRS U33     | 1        | 9             | 16 A |
| ZHBW126A0          | HM121M U33       |          | 12            | 40 A |
| ZHBW146A0          | HM141M U33       |          | 14            | 40 A |
| ZHBW166A0          | HM161M U33       |          | 16            | 40 A |
| ZHBW128A0          | HM123M U33       | 3        | 12            | 16 A |
| ZHBW148A0          | HM143M U33       |          | 14            | 16 A |
| ZHBW168A0          | HM163M U33       |          | 16            | 16 A |
| ZHBW056A1          | HM051MR U44      | 1        | 5             | 16 A |
| ZHBW076A1          | HM071MR U44      |          | 7             | 20 A |
| ZHBW096A1          | HM091MR U44      |          | 9             | 25 A |
| ZHBW126A1          | HM121MR U34      | 1        | 12            | 40 A |
| ZHBW146A1          | HM141MR U34      |          | 14            | 40 A |
| ZHBW166A1          | HM161MR U34      |          | 16            | 40 A |
| ZHBW128A1          | HM123MR U34      |          | 12            | 16 A |
| ZHBW148A1          | HM143MR U34      | 3        | 14            | 16 A |
| ZHBW168A1          | HM163MR U34      |          | 16            | 16 A |

| Power cable<br>(Type : H07RNF) |                          |
|--------------------------------|--------------------------|
| Current [A]                    | Area [mm <sup>2</sup> ]  |
| [A] ≤ 0.2                      | Tinsel cord <sup>a</sup> |
| 0.2 < [A] ≤ 3                  | 0.5 <sup>a</sup>         |
| 3 < [A] ≤ 6                    | 0.75                     |
| 6 < [A] ≤ 10                   | 1.0 (0.75) <sup>b</sup>  |
| 10 < [A] ≤ 16                  | 1.5 (1.0) <sup>b</sup>   |
| 16 < [A] ≤ 25                  | 2.5                      |
| 25 < [A] ≤ 32                  | 4                        |
| 32 < [A] ≤ 40                  | 6                        |
| 40 < [A] ≤ 63                  | 10                       |

a These cords may only be used if their length does not exceed 2 m between the point where the cord or cord guard enters the appliance and the entry to the plug.

b Cords having the cross-sectional areas indicated in the parentheses may be used for portable appliances if their length does not exceed 2 m.

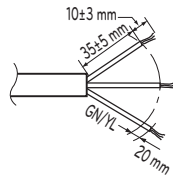

For the 1-Phase

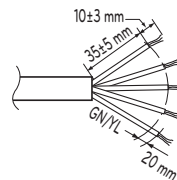

For the 3-Phase

**Precautions when laying power wiring**

Use round pressure terminals for connections to the power terminal block.

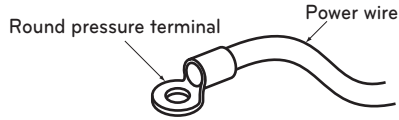

When none are available, follow the instructions below.

- Do not connect wiring of different thicknesses to the power terminal block. (Slack in the power wiring may cause abnormal heat.)
- When connecting wiring which is the same thickness, do as shown in the figure below.

Connect same thickness wiring to both sides.

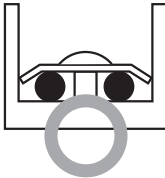

It is forbidden to connect two to one side.

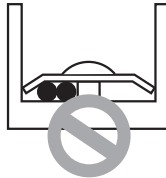

It is forbidden to connect wiring of different thicknesses.



- For wiring, use the designated power wire and connect firmly, then secure to prevent outside pressure being exerted on the terminal block.
- Use an appropriate screwdriver for tightening the terminal screws. A screwdriver with a small head will strip the head and make proper tightening impossible.
- Over-tightening the terminal screws may break them.

**⚠ WARNING**

- Make sure that the screws of the terminal are free from looseness.

**Point for attention regarding quality of the public electric power supply (For 3 Series)**

- European/International Technical Standard setting the limits for voltage changes, voltage fluctuations and flicker in public low-voltage supply systems for equipment with rated current  $\leq 75$  A.
- European/International Technical Standard setting the limits for harmonic currents produced by equipment connected to public low-voltage systems with input current  $\leq 16$  A or  $> 75$  A per phase.

**For 1 Phase (12, 14, 16 kW)**

- This equipment complies with IEC (EN) 61000-3-12 in harmonic currents emission limits corresponding  $R_{sce} = 33$ .
- This equipment complies with reference impedance for IEC (EN) 61000-3-3.

**For 3 Phase (12, 14, 16 kW)**

- This equipment complies with IEC (EN) 61000-3-12 provided that the short-circuit power  $S_{sc}$  is greater than or equal to 2067 kVA at the interface point between the user's supply and the public system. It is the responsibility of the installer or user of the equipment to ensure, by consultation with the distribution network operator if necessary, that the equipment is connected only to a supply with a short-circuit power  $S_{sc}$  greater than or equal to 2067 kVA.
- This equipment complies with IEC (EN) 61000-3-3.

**For 1 Phase (5,7, 9 kW)**

- This equipment complies with IEC (EN) 61000-3-12 in harmonic currents emission limits corresponding  $R_{sce} = 33$ .
- This equipment complies with IEC (EN) 61000-3-3.

---

### **Point for attention regarding quality of the public electric power supply (For 4 Series)**

- European/International Technical Standard setting the limits for voltage changes, voltage fluctuations and flicker in public low-voltage supply systems for equipment with rated current  $\leq 75$  A.
- European/International Technical Standard setting the limits for harmonic currents produced by equipment connected to public low-voltage systems with input current  $\leq 16$  A or  $> 75$  A per phase.

### **For 1 Phase (12, 14, 16 kW)**

- This equipment complies with IEC (EN) 61000-3-12 in harmonic currents emission limits corresponding  $R_{sce} = 33$ .
- This equipment complies with reference impedance for IEC (EN) 61000-3-11.

---

### **For 3 Phase (12, 14, 16 kW)**

- This equipment complies with IEC (EN) 61000-3-12 provided that the short-circuit power  $S_{sc}$  is greater than or equal to 2672 kVA at the interface point between the user's supply and the public system. It is the responsibility of the installer or user of the equipment to ensure, by consultation with the distribution network operator if necessary, that the equipment is connected only to a supply with a short-circuit power  $S_{sc}$  greater than or equal to 2672 kVA.
- This equipment complies with IEC (EN) 61000-3-3.

---

### **For 1 Phase (5,7 kW)**

- This equipment complies with IEC (EN) 61000-3-2.
- This equipment complies with IEC (EN) 61000-3-3.

### **For 1 Phase (9 kW)**

- This equipment complies with IEC (EN) 61000-3-12 in harmonic currents emission limits corresponding  $R_{sce} = 33$ .
  - This equipment complies with IEC (EN) 61000-3-3.
-

## Circuit Breaker Specification

Perform the electrical wiring work according to the electrical wiring connection.

- All wiring must comply with local requirements.
- Select a power source that is capable of supplying the current required by the appliance.
- Use a recognized ELCB(Electric Leakage Circuit Breaker) between the power source and the unit. A disconnection device to adequately disconnect all supply lines must be fitted.
- Model of circuit breaker recommended by authorized personnel Only.
- Select a circuit breaker suitable for the current specification.

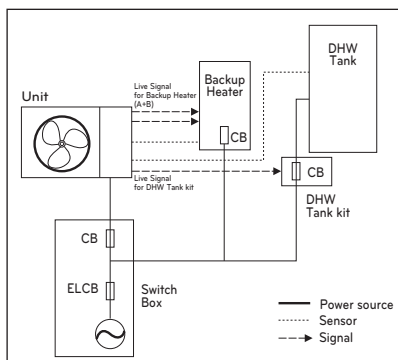

\*CB : Circuit Breaker

\*ELCB : Electric Leakage Circuit Breaker

## Wiring procedure for power cable

This cable is generally connected between external power source (such as main electric power distribution panel of user's house) and the unit. Before starting wiring, check if wire specification is suitable and read following directions and cautions VERY carefully.

### ⚠ CAUTION

**After checking and confirming following conditions, start wiring work.**

- Secure dedicated power source for the Air-to-Water heat pump. The wiring diagram (attached inside the control box of the unit) is presenting related information.
- Provide a circuit breaker switch between power source and the outdoor unit.
- Although it is very rare case, sometimes the screws used to fasten internal wires can be loosen due to the vibration while product transportation. Check these screws and make it sure if they are all fastened tightly. If not tightened, burn-out of the wire can be occurred.
- Check the specification of power source such as phase, voltage, frequency, etc.
- Confirm that electrical capacity is sufficient.
- Be sure that the starting voltage is maintained at more than 90 percent of the rated voltage marked on the name plate.
- Confirm that the cable thickness is as specified in the power sources specification. (Particularly note the relation between cable length and thickness.)
- Provide an ELB(electric leakage breaker) when the installation place is wet or moist.
- The following troubles would be caused by abnormal voltage supply such as sudden voltage increasing or voltage drop-down.
  - Chattering of a magnetic switch (frequent on and off operation)
  - Physical damage of parts where magnetic switch is contacted
  - Break of fuse
  - Malfunction of overload protection parts or related control algorithms.
  - Failure of compressor start up
  - Ground wire to ground outdoor unit to prevent electrical shock.

**Step 1.** Disassemble side panel and front panel from the unit by loosening screws.

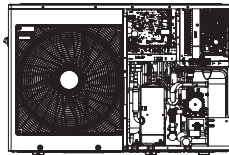

UN36A (5, 7, 9 kW)

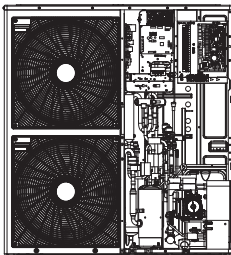

UN60A(1Ø : 9, 12, 14, 16 kW)

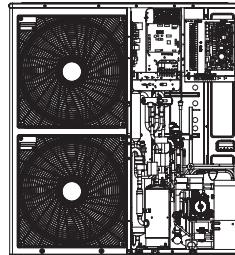

UN60A(3Ø : 12, 14, 16 kW)

\* The feature may vary according to the type of model.

**Step 2.** Connect power cable to main power terminal

See below figure for detailed information. When connecting earth cable, the diameter of cable should refer to the below table. The earth cable is connected to the Control box case where earth symbol is  $\oplus$  marked.

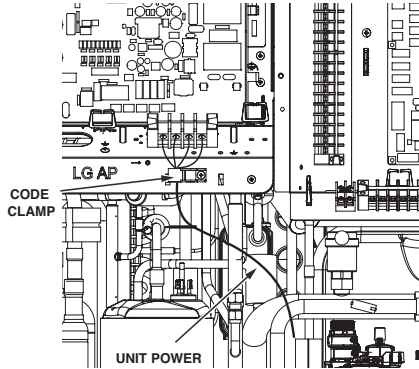
**Step 3.** Use cable clamps (or cord clamps) to prevent unintended move of power cable.**Step 4.** Reassemble the side panel to the unit by fastening screws.

UN36A (5, 7, 9 kW)

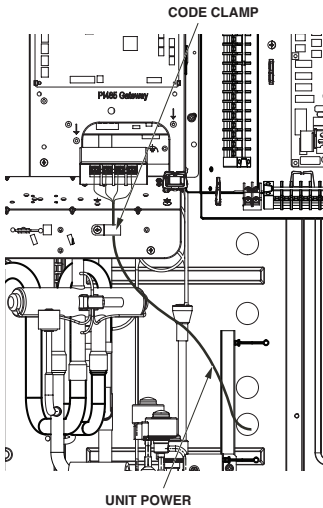

UN60A(1Ø : 9, 12, 14, 16 kW)

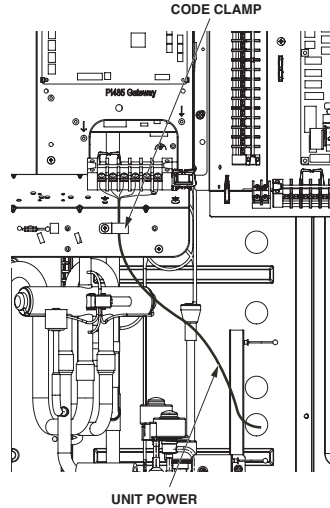

UN60A(3Ø : 12, 14, 16 kW)

Failure to do these instruction can result in fire, electric shock or death.

- Make sure the power cable do not touch to copper tube.
- Make sure to fix [cord clamp] firmly to sustain the connection of terminal.
- Make sure to connect unit power & heater power separately.

\* The feature may be vary according to the type of model.

## Terminal Block Information

### - For 3 Series

Symbols used below pictures are as follows :

- L, L1, L2 : Live (220-240 V~)
- N : Neutral (220-240 V~)
- BR : Brown, WH : White, BL : Blue, BK : Black

### Case 1

#### Terminal Block 1

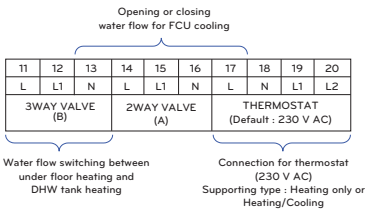
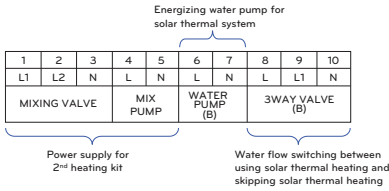

### Case 2

#### Terminal Block 1

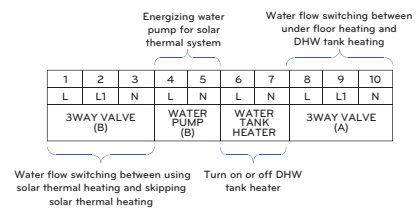

#### Terminal Block 2

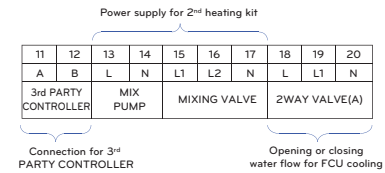

#### Terminal Block 2



#### Terminal Block 3

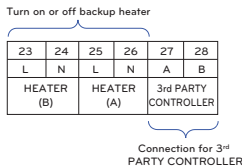

#### Terminal Block 3

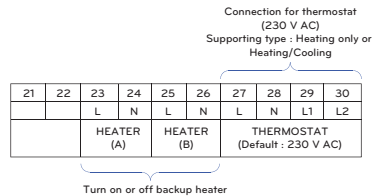

#### Terminal Block 4

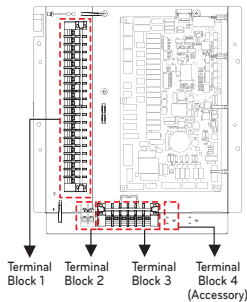
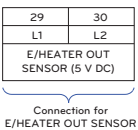

#### Terminal Block 4

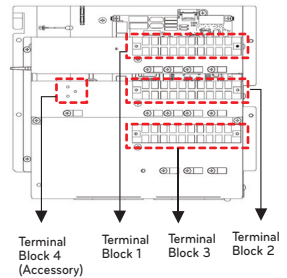
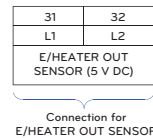

\* Refer to Terminal Block Information according to the C/Box shape.

- For 4 Series

Symbols used below pictures are as follows :

- L, L1, L2 : Live (220-240 V~)
- N : Neutral (220-240 V~)
- BR : Brown, WH : White, BL : Blue, BK : Black

Terminal Block 1

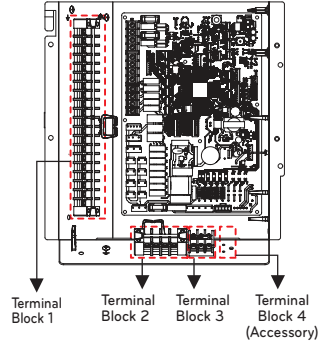
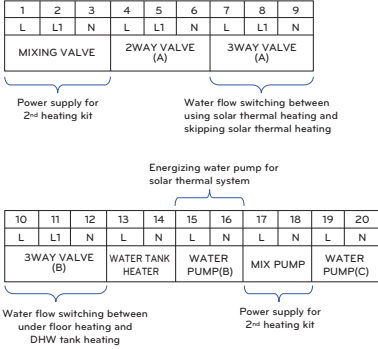

Terminal Block 2

Terminal Block 3

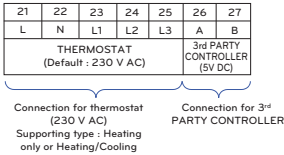

Terminal Block 4

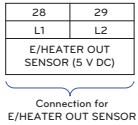

\* Refer to Terminal Block Information according to the C/Box shape.

## Wiring of main power supply and equipment capacity

1. Use a separate unit power and heater power.
2. Bear in mind ambient conditions (ambient temperature, direct sunlight, rain water, etc.) when proceeding with the wiring and connections.
3. The wire size is the minimum value for metal conduit wiring. The power cord size should be 1 rank thicker taking into account the line voltage drops. Make sure the power-supply voltage does not drop more than 10 %.
4. Specific wiring requirements should adhere to the wiring regulations of the region.
5. Power supply cords of parts of appliances for unit use should not be lighter than polychloroprene sheathed flexible cord.
6. Don't install an individual switch or electrical outlet to disconnect each of unit separately from the power supply.

### WARNING

- Follow ordinance of your governmental organization for technical standard related to electrical equipment, wiring regulations and guidance of each electric power company.
- Make sure to use specified wires for connections so that no external force is imparted to terminal connections. If connections are not fixed firmly, it may cause heating or fire.
- Make sure to use the appropriate type of overcurrent protection switch. Note that generated overcurrent may include some amount of direct current.

### CAUTION

- Some installation site may require attachment of an earth leakage breaker. If no earth leakage breaker is installed, it may cause an electric shock.
- Do not use anything other than breaker and fuse with correct capacity. Using fuse and wire or copper wire with too large capacity may cause a malfunction of unit or fire.

## Water Piping and Water Circuit Connection

### CAUTION

Followings are should be considered before beginning water circuit connection.

- Service space should be secured.
- Water pipes and connections should be cleaned using water.
- Space for installing external water pump should be provided if internal water pump capacity is not enough for installation field.
- Never connect electric power while proceeding water charging.

Definition of terms are as follow :

- Water piping : Installing pipes where water is flowing inside the pipe.
- Water circuit connecting : Making connection between the unit and water pipes or between pipes and pipes. Connecting valves or elbows are, for example, in this category.

Configuration of water circuit is shown in "Installation Scenes". All connections should be complied with presented diagram.

While installing water pipes, followings should be considered :

- While inserting or putting water pipes, close the end of the pipe with pipe cap to avoid dust entering.
- When cutting or welding the pipe, always be careful that inner section of the pipe should not be defective. For example, no weldments or no burrs are found inside the pipe.
- Drain piping should be provided in case of water discharge by the operation of the safety valve. This situation can be happened when the internal pressure is over 3.0 bar and water inside the unit will be discharged to drain hose.
- Pipe fittings (e.g. L-shape elbow, T-shape tee, diameter reducer, etc) should be tightened strongly to be free from water leakage.
- Connected sections should be leakage-proof treatment by applying tefron tape, rubber bushing, sealant solution, etc.
- Appropriate tools and tooling methods should be applied to prevent mechanical breakage of the connections.
- Operation time of flow valve(e.g. 3way valve or 2way valve) should be less than 90 seconds.
- While supplying water, pressure of supplying water should be 2.0 bar approximately.
- Pipe is insulated to prevent heat loss to external environment and to prevent dew generation on the surface of the pipe in cooling operation.
- Maximum allowable Torque at the water piping connection is 50 N·m

When the water pipes are connected. It must be tightened the nut with two wrench. Otherwise pipes can be deformed.

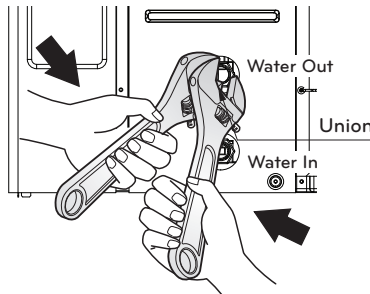

\* The feature may vary according to the type of model.

## ⚠ WARNING

### Installing shut-off valve

- While assembling two shut-off valves, pop sound will be heard when valve is open or close by rotating handles. It is normal condition because the sound is due to leakage of charged nitrogen gas inside the valve. The nitrogen gas is applied to secure quality assurance.
- Before starting water charging, these two shut-off valves should be assembled with water inlet and outlet pipe of the unit.

### Water condensation on the floor

While cooling operation, it is very important to keep leaving water temperature higher than 16 °C. Otherwise, dew condensation can be occurred on the floor.

If floor is in humid environment, do not set leaving water temperature below 18 °C.

### Water condensation on the radiator

While cooling operation, cold water may not flow to the radiator. If cold water enters to the radiator, dew generation on the surface of the radiator can be occurred.

### Water Pipe Insulation

Purpose of water pipe insulation is :

To prevent heat loss to external environment.

To prevent dew generation on the surface of the pipe in cooling operation.

To prevent pipe breakage by freeze at winter season,

※ Must be insulation at exterior water pipe between product and building.

## Water Charging

For water charging, please follow below procedures.

**Step 1.** Open all valves of whole water circuit. Supplied water should be charged not only inside the unit, but also in the under floor water circuit, DHW water tank circuit, FCU water circuit, and any other water circuits controlled by the product.

**Step 2.** Connect supply water into drain valve and fill valve located at the side of the shut-off valve.

### CAUTION

No water-leakage permitted at the drain and fill valve. Leakage-proof treatment which is described in previous section should be applied.

**Step 3.** Start to supply water. While supplying water, following should be kept.

- Pressure of supplying water should be 2.0 bar approximately.
- For supplying water pressure, time to be taken from 0 bar to 2.0 bar should be more than 1 minute. Sudden water supply can yield water drain through safety valve.
- Fully open the cap of air vent to assure air purging. If air is exist inside the water circuit, then performance degrade, noise at the water pipe, mechanical damage at the surface of electric heater coil.
- Open both the air vent in the water pipe and the air vent in the pump.

**Step 4.** Stop water supplying when the pressure gage located in front of the control panel indicates 2.0 bar.

**Step 5.** Close drain valve and fill valve. Then wait for 20~30 seconds to observe water pressure being stabilized.

**Step 6.** If following conditions are satisfactory, then go to Next process(Pipe Insulation). Otherwise, go to step 3.

- Pressure gage indicates 2.0 bar. Note that sometimes pressure in decreased after step 5 due to water charging inside expansion vessel.
- No air purging sound is heard or no water drop are popping out from air vent.

### CAUTION

Keep the air vent of the water pipe open and keep the air vent of the pump closed. Otherwise, the pump may make noise.

## Pipe Insulation

Purpose of water pipe insulation is :

- To prevent heat loss to external environment
- To prevent dew generation on the surface of the pipe in cooling operation

## Water pump Capacity

The water pump is variable type which is capable to change flow rate, so it may be required to change default water pump capacity in case of noise by water flow. In most case, however, it is strongly recommended to set capacity as Maximum.

### NOTE

- To secure enough water flow rate, do not set water pump capacity as Minimum. It can lead unexpected flow rate error CH14.

## Pressure Drop

### NOTE

When installing the product, install additional pump in consideration of the pressure loss and pump performance. If flow rate is low, overloading of product can occur

#### (For GRUNDFOS Water Pump)

| Capacity [kW] | Rated flow-rate [LPM(m <sup>3</sup> /h)] | Pump Head [m] (At rated flow rate) | Product pressure drop [m] (Plate heat exchanger) | Serviceable Head [m] |
|---------------|--|------------------------------------|--|----------------------|
| 16            | 46.0 (2.8)                               | 8.3                                | 1.4  | 6.9                  |
| 14            | 40.25 (2.4)                              | 9.3                                | 1.1  | 8.2                  |
| 12            | 34.5 (2.1)                               | 9.8                                | 0.8  | 9.0                  |
| 9             | 25.87 (1.5)                              | 6.1                                | 0.4  | 5.7                  |
| 7             | 20.12 (1.2)                              | 7.3                                | 0.3  | 7.0                  |
| 5             | 15.8 (0.9)                               | 7.5                                | 0.2  | 7.3                  |

#### (For OH SUNG Water Pump)

| Capacity [kW] | Rated flow-rate [LPM(m <sup>3</sup> /h)] | Pump Head [m] (At rated flow rate) | Product pressure drop [m] (Plate heat exchanger) | Serviceable Head [m] |
|---------------|--|------------------------------------|--|----------------------|
| 16            | 46.0 (2.8)                               | 8.5                                | 1.4  | 7.1                  |
| 14            | 40.3 (2.4)                               | 9.1                                | 1.1  | 8.0                  |
| 12            | 34.5 (2.1)                               | 9.7                                | 0.8  | 8.9                  |
| 9             | 25.9 (1.5)                               | 10.3                               | 0.4  | 9.9                  |
| 7             | 20.1 (1.2)                               | 10.7                               | 0.3  | 10.4                 |
| 5             | 15.8 (0.9)                               | 10.9                               | 0.2  | 10.7                 |

### Performance curve

GRUNDFOS Water Pump : UPML GEO 20 – 105 CHBL  
UN60A (12, 14, 16 kW)

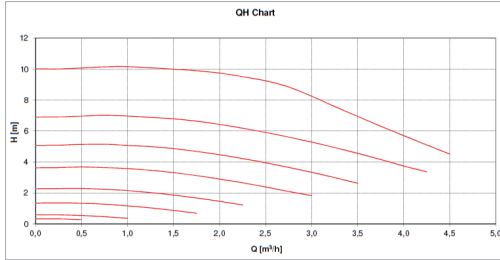

GRUNDFOS Water Pump : UPM3K GEO 20 – 75 CHBL  
UN36A (5, 7, 9 kW), UN60A (9 kW)

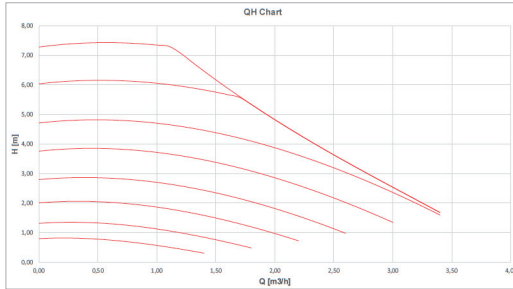

OH SUNG Water Pump : ODM-061P  
UN60A (12, 14, 16 kW), UN36A (5, 7, 9 kW)

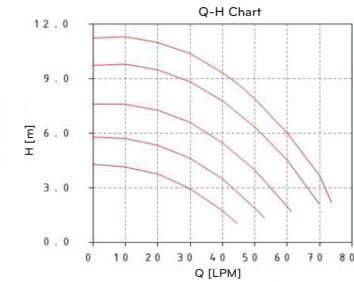

Performance test based on standard ISO 9906 with pre-pressure 2.0 bar and liquid temperature 20 °C.

### WARNING

- Selecting a water flowrate outside the curves can cause damage to or malfunction of the unit.

## Water Quality

Water quality should be complied with EN 98/83 EC Directives.  
Detailed water quality condition can be found in EN 98/83 EC Directives.

### CAUTION

- If the product is installed at existing hydraulic water loop, it is important to clean hydraulic pipes to remove sludge and scale.
- Installing sludge strainer in the water loop is very important to prevent performance degrade.
- Chemical treatment to prevent rust should be performed by installer.
- It is strongly recommended to install an additional filter on the heating water circuit. Especially to remove metallic particles from the heating piping, it is advised to use a magnetic or cyclone filter, which can remove small particles. Small particles may damage the unit and will NOT be removed by the standard filter of the heat pump system.

## Frost protection by antifreeze

In areas of the country where entering water temperatures drop below 0 °C, the water pipe must be protected by using an approved antifreeze solution. Consult your AWHP unit supplier for locally approved solutions in your area. Calculate the approximate volume of water in the system. (Except the AWHP unit.) And add six liters to this total volume to allow for the water contained in AWHP unit.

| Antifreeze type  | Antifreeze mixing ratio |       |        |        |        |        |
|------------------|-------------------------|-------|--------|--------|--------|--------|
|                  | 0 °C                    | -5 °C | -10 °C | -15 °C | -20 °C | -25 °C |
| Ethylene glycol  | 0 %                     | 12 %  | 20 %   | 30 %   | -      | -      |
| Propylene glycol | 0 %                     | 17 %  | 25 %   | 33 %   | -      | -      |
| Methanol         | 0 %                     | 6 %   | 12 %   | 16 %   | 24 %   | 30 %   |

If you use frost protection function, change DIP switch setting and input the temperature condition in Installation mode of remote controller. Refer to 'CONFIGURATION > DIP Switch Setting > DIP Switch Information > Option Switch 3' and 'INSTALLER SETTING > Antifreezing Temperature'.

### CAUTION

- Use only one of the above antifreeze.
- If a antifreeze is used, pressure drop and capability degradation of the system can be occurred.
- If one of antifreezes is used, corrosion can be occurred. So please add corrosion inhibitor.
- Please check the concentration of the antifreeze periodically to keep same concentration.
- When the antifreeze is used (for installation or operation), take care to ensure that antifreeze must not be touched.
- Ensure to respect all laws and norms of your country about Anti-freeze usage.

## Frost protection by antifreeze valve

### About antifreeze valve

This is a valve to prevent freeze in winter. When no antifreeze is added to the water, you can use antifreeze valves at all lowest points of the field piping to drain the water from the system before it can freeze.

### To install antifreeze valve

To protect the field piping against freezing, install the following parts:

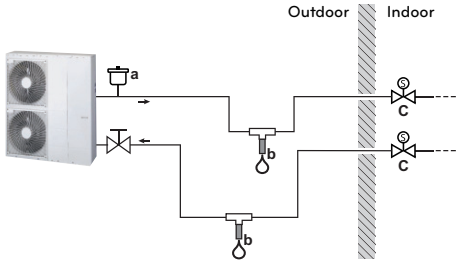

- a Automatic air intake
- b Antifreeze valve (Optional – field supply)
- c Normally closed valves (recommended – field supply)

| Part | Description   |
|------|---|
|      | An automatic air intake (for air supply) should be installed at the highest point. For example, an automatic air purge.   |
|      | Protection for the field piping. The antifreeze valve must be installed: <ul style="list-style-type: none"> <li>• Vertically to allow water to flow out properly and free from obstructions.</li> <li>• At all lowest points of the field piping.</li> <li>• In the coldest part and away from heat sources.</li> </ul>   |
|      | Isolation of water inside the house when there is a power interruption. Normally closed valves (located indoors near the piping entry/exit points) can prevent that all water from indoor piping is drained when the antifreeze valve open. <ul style="list-style-type: none"> <li>• <b>When there is a power interruption:</b> The normally closed valves close and isolate the water inside the house. If the antifreeze valve open, only the water outside the house is drained.</li> <li>• <b>In other circumstances</b> (example: when there is a pump failure): The normally closed valves remain open. If the antifreeze valve open, the water from inside the house is also drained.</li> </ul> |

**NOTE**

- Do not make any trap connections. If the shape of the connection pipe has the potential to create a trap effect, part of the pipe will not be able to drain and frost protection will no longer be guaranteed.
- Leave at least 15 cm clearance from the ground to prevent ice from blocking the water exit.
- Keep a distance of at least 10 cm between the antifreeze valves.
- The valve must be free of insulation for the system to work properly.
- When antifreeze valves are installed, do NOT select a minimum cooling setpoint lower than 7 °C. If lower, antifreeze valves can open during cooling operation.
- When installed outdoors, the antifreeze valve must be protected from rain, snow and direct sunlight.

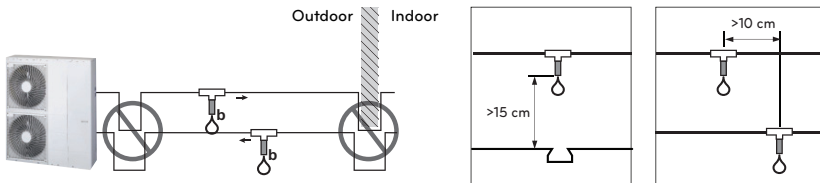

## Water Volume and Expansion Vessel Pressure

Inside expansion vessel is included which is 8 liter capacity with 1 bar pre-pressure. That means, according to the volume-pressure graph, total water volume of 230 liter is supported as default. If total water volume is changed because of installation condition, the pre-pressure should be adjusted to secure proper operation.

- Minimum total water volume is 20 liter.
- Pre-pressure is adjusted by the total water volume. If the indoor is located at the highest position of the water circuit, adjustment is not required.
- To adjust pre-pressure, use nitrogen gas by certificated installer.

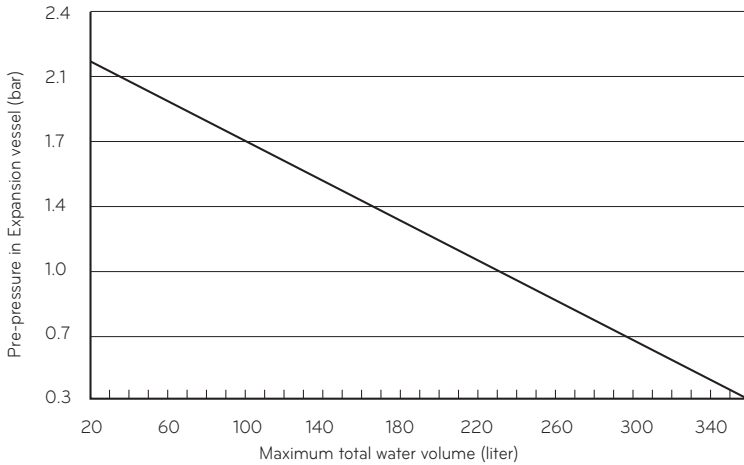

Adjusting pre-pressure of expansion vessel is as following :

**Step 1.** Refer "Volume-Height" table.

If installation scene is belong to Case A, go to Step 2.

Otherwise, if it is Case B, do nothing. (pre-pressure adjustment is not required.)

Otherwise, if it is Case C, go to Step 3.

**Step 2.** Adjust pre-pressure by following equation.

$$\text{Pre-pressure [bar]} = (0.1 \times H + 0.3) \text{ [bar]}$$

where H : difference between unit and the highest water pipe

0.3 : minimum water pressure to secure product operation

**Step 3.** Volume of expansion vessel is less than installation scene.

Please install additional expansion vessel at the external water circuit.

Volume-Height Table

|         | V < 230 liter | V ≥ 230 liter |
|---------|---------------|---------------|
| H < 7 m | Case B        | Case A        |
| H ≥ 7 m | Case A        | Case C        |

H : difference between unit and the highest water pipe

V : total water volume of installation scene

# ACCESSORIES INSTALLATION

**THERMAV.** can interface to various accessories to extend its functionality and to improve user convenience. In this chapter, specifications about supported 3rd party accessories and how to connect to **THERMAV.** is introduced.

It is noted that this chapter only deal with 3rd party accessories. For accessories supported by LG Electronics, please refer to installation manual of each accessories.

## Accessories supported by LG Electronics

| Item                       | Purpose   | Model   |
|----------------------------|---|---|
| DHW Tank Install Kit       | To operate with DHW tank  | PHLTB   |
| Thermistor for DHW Tank    | To control hot water temperature of DHW tank                                  | PHRSTAO   |
| Remote Temperature Sensor  | To control by air temperature   | PQRSTAO   |
| Dry Contact                | To receive on & off external signal   | PDRYCB000   |
|                            | Dry Contact For Thermostat  | PDRYCB300   |
| Solar thermal Kit          | To operate with solar heating system  | PHLLA(Limit temperature : 96 °C)  |
| Meter Interface            | To measure production / consumption power                                     | PENKTH000   |
| Central Controller         | Multiple installed products into one central control                          | AC EZ Touch (PACEZA000)<br>AC Smart IV (PACS4B000)<br>AC Smart 5 (PACS5A000)<br>ACP 5 (PACP5A000)<br>AC Manager 5 (PACM5A000) |
| Backup heater              | To supplement insufficient capacity   | HA031M E1 / HA061M E1 / HA063M E1   |
| Wi-Fi Modem                | To enable remote system operation from smartphone                             | PWFMD200  |
| Thermistor for 2nd Circuit | To interlock with 2nd circuit operation and control temperature of main zone. | PRSTAT5K10  |
| Extension wire             | To connect remote controller with Indoor PCB for communication                | PZCWRC1   |
| PI485                      | To communicate and control through the central controller                     | For 3 Series: PMNFP14A1<br>For 4 Series: PP485A00T  |
| ESS                        | To control the operation mode according to the energy storage state           | HOME 8 (PCS) : D008KE1N211<br>HOME10(PCS) : D010KE1N211<br>HB7H(Battery) : BLGRESU7H<br>HB10H(Battery) : BLGRESU10H           |

| Item                                   | Purpose   | Model  |
|--|---|--|
| DHW Tank                               | To generate and store hot water   | OSHW-200F : 200 L, Single Heating Coil, 1Ø 230 V 50 Hz 2.4 kW Booster heater<br>OSHW-300F : 300 L, Single Heating Coil, 1Ø 230 V 50 Hz 2.4 kW Booster heater<br>OSHW-500F : 500 L, Single Heating Coil, 1Ø 230 V 50 Hz 2.4 kW Booster heater<br>OSHW-300F : 300 L, Double Heating Coil, 1Ø 230 V 50 Hz 2.4 kW Booster heater |
| Cloud Gateway                          | To use Becon cloud  | PWFMDB200  |
| Wi-Fi Modem                            | To enable remote system operation from smartphone   | PWFMD200   |
| Extension cable for Wi-Fi Modem        | To connect with Wi-Fi modem to the USB cable  | PWYREW000  |
| Thermistor for 2nd Circuit or E/Heater | To interlock with 2nd circuit operation and control temperature of main zone or To interlock with 3rd party E/Heater and control temperature of water out 3rd party E/Heater. | PRSTAT5K10   |
| RS3 remote controller                  | To control unit with 2 remote controllers   | PREMTW101  |
| 2-Remo Control Wire                    | The wire for 2 remo control   | PZCWRC2  |

## Accessories supported by 3<sup>rd</sup> party Companies

| Item                                | Purpose   | Specification  |
|-------------------------------------|---|--|
| Solar Heating System                | To generate auxiliary heating energy for water tank   | <ul style="list-style-type: none"> <li>• Solar collector</li> <li>• 3way valve(B)</li> </ul> |
| Mix Kit                             | To use 2nd Circuit  | <ul style="list-style-type: none"> <li>• Mixing valve</li> <li>• Mix pump</li> </ul>         |
| 3rd Party Boiler                    | To use auxiliary boiler.  |  |
| 3rd Party Controller                | To connect external controller using modbus protocol  |  |
| Thermostat                          | To control by air temperature   | Heating-Only type (230 V AC)<br>Cooling/Heating type (230 V AC with Mode selection switch)   |
| 3way valve and actuator             | (A) : To control water flow for hot water heating or floor heating /<br>To control water flow when installing 3rd party boiler<br>(B) : To control close/open mode of solar circuit | 3 wire, SPDT<br>(Single Pole Double Throw) type, 230 V AC                                    |
| 2way valve and actuator             | To control water flow for Fan Coil Unit / To serve as 3way valve when installing backup heater  | 2 wire, SPST<br>(Single Pole Sing Throw) type, 230 V AC                                      |
| External Pump                       | To retain sufficient capacity using additional pump   |  |
| Smart Grid                          | To control operation mode depending on input signal from provider   |  |
| 3 <sup>rd</sup> Party ESS           | To control the operation mode according to the energy storage state   | (For 4 Series)   |
| 3 <sup>rd</sup> party Backup heater | To supplement in sufficient capacity  | (For 4 Series)   |
| Antifreeze valve                    | To protect the pipes against freezing   |  |
| DHW Recirculation Pump              | To control the water flow of DHW recirculation pump   | (For 4 Series)   |

## Before Installation

### ! WARNING

Followings should be kept before installation

- Main power must be turned off during installing 3rd party accessories.
- 3rd party accessories should be comply with supported specification.
- Proper tools should be chosen for installation.
- Never do installation with wet hands.

## Thermostat

Thermostat is generally used to control the product by air temperature. When thermostat is connected to the product, the product operation is controlled by the thermostat.

### Installation condition

### ! CAUTION

- USE 220-240 V~ Thermostat
- Some electro-mechanical type thermostat has internal delay time to protect compressor. In that case, mode change can takes time more than user's expectation. Please read thermostat manual carefully if the unit does not response quickly.
- Setting temperature range by thermostat can be different with that of the unit. The heating or cooling set temperature should be chosen within the setting temperature range of the unit.
- It is highly recommended that the thermostat should be installed where space heating is mainly applied.

Following location should be avoid to secure proper operation :

- Height from floor is approximately 1.5 m.
- Thermostat can not be located where the area may be hidden when door is open.
- Thermostat can not be located where external thermal influence may be applied. (such as above heating radiator or open window)

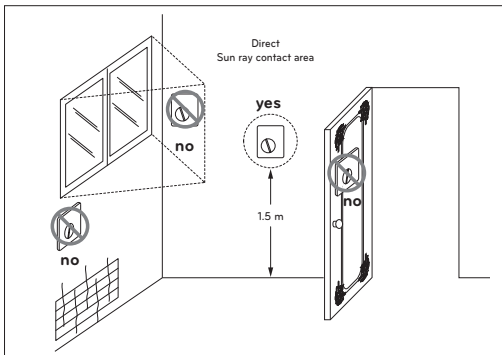

## General Information

The Heat Pump supports following thermostats.

| Type              | Power  | Operating Mode                      | Supported |
|-------------------|--------|-------------------------------------|-----------|
| Mechanical<br>(1) | 230 V~ | Heating Only (3)                    | Yes       |
|                   |        | Heating / Cooling (4)               | Yes       |
|                   |        | Heating / Cooling / DHW Heating (5) | Yes       |
| Electrical<br>(2) | 230 V~ | Heating Only (3)                    | Yes       |
|                   |        | Heating / Cooling (4)               | Yes       |
|                   |        | Heating / Cooling / DHW Heating (5) | Yes       |

- (1) There is no electric circuit inside the thermostat and electric power supply to the thermostat is not required.
- (2) Electric circuit such as display, LED, buzzer, etc is included in the thermostat and electric power supply is required.
- (3) Thermostat generates "Heating ON or Heating OFF" signal according to user's heating target temperature.
- (4) Thermostat generates both "Heating ON or Heating OFF" and "Cooling ON or Cooling OFF" signal according to user's heating and cooling target temperature.
- (5) Thermostat generates "Heating ON or Heating OFF", "Cooling ON or Cooling OFF", "DHW Heating ON or DHW Heating OFF" signal according to user's heating, cooling and DHW heating target temperature. (For Split Indoor unit 5 Series, For Hydrosplit)



## CAUTION

Choosing heating / cooling thermostat

- Heating / cooling thermostat must have "Mode Selection" feature to distinguish operation mode.
- Heating / cooling thermostat must be able to assign heating target temperature and cooling target temperature differently.
- If above conditions are not kept, the unit can not operation properly.
- Heating / cooling thermostat must send cooling or heating signal immediately when temperature condition is satisfied. No delay time while sending cooling or heating signal is permitted.

## How to wire thermostat

Follow below procedures Step 1 ~ Step 5.

**Step 1.** Uncover front cover of the unit and open the control box.

**Step 2.** Identify the power specification of the thermostat. If it is 220-240 V~, go to Step 3.

**Step 3.** If it is Heating only thermostat, go to step 4. Otherwise, if it is Heating / cooling thermostat, go to step 5.

**Step 4.** Find terminal block and connect wire as below.

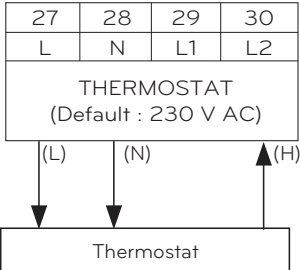

### ! WARNING

Mechanical type thermostat

Do not connect wire (N) as mechanical type thermostat does not require electric power supply.

### ! CAUTION

Do not connect external electric loads.

Wire (L) and (N) should be used only for operation electric type thermostat.

Never connect external electric loads such as valves, fan coil units, etc. If connected, Main PCB (Heater) can be seriously damaged.

(L) : Live signal from PCB to thermostat

(N) : Neutral signal from PCB to thermostat

(H) : Heating signal from thermostat to PCB

※ The terminal block connection number may differ depending on the model. Refer to the "Wiring Diagram" in the SVC Manual.

**Step 5.** Find terminal block and connect wire as below.

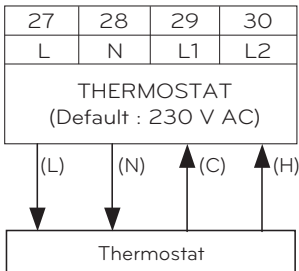

### ! WARNING

Mechanical type thermostat

Do not connect wire (N) as mechanical type thermostat does not require electric power supply.

### ! CAUTION

Do not connect external electric loads.

Wire (L) and (N) should be used only for operation Electric type thermostat.

Never connect external electric loads such as valves, fan coil units, etc. If connected, Main PCB (Heater) can be seriously damaged.

(L) : Live signal from PCB to thermostat

(N) : Neutral signal from PCB to thermostat

(C) : Cooling signal from thermostat to PCB

(H) : Heating signal from thermostat to PCB

## How to wire Heating / Cooling / DHW Heating thermostat (For 4 Series)

Follow below procedures Step 1 ~ Step 3.

**Step 1.** Uncover front cover of the unit and open the control box.

**Step 2.** Identify the power specification of the thermostat. If it is 220-240 V~, go to Step 3.

**Step 3.** Find terminal block and connect wire as below.

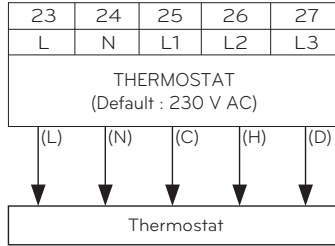

### ! WARNING

Mechanical type thermostat.

Do not connect wire (N) as mechanical type thermostat does not require electric power supply.

### ! CAUTION

Do not connect external electric loads.

Wire (L) and (N) should be used only for operation electric type thermostat.

Never connect external electric loads such as valves, fan coil units, etc. If connected, Main PCB (Heater) can be seriously damaged.

(L) : Live signal from PCB to thermostat

(N) : Neutral signal from PCB to thermostat

(C) : Cooling signal from thermostat to PCB

(H) : Heating signal from thermostat to PCB

(D) : DHW Heating signal from thermostat to PCB

## Final check

- DIP switch setting :  
Set DIP switch No. 8 to 'ON'. Otherwise, the unit can not recognize the thermostat.
- Remote Controller :
  - 'Thermostat' text is displayed on the remote controller.
  - Button input is prohibited.
  - In case of Heating / Cooling / DHW Heating thermostat, select 'Heat&Cool / DHW' as the Thermostat Control Type in the remote controller installer settings.

## 2<sup>nd</sup> Circuit

The 2nd circuit is generally used to control the temperature of 2 rooms differently. To use the 2nd Circuit, you need to prepare a separate Mix Kit. The mix kit must be installed in the main zone.

- Main Zone : zone where the water temperature is lowest when heating.
- Add. Zone : The other zone

### - For 3 Series

#### [Install Guide 2<sup>nd</sup> Circuit Heating]

| Main Zone<br>Add. Zone    | Floor (35 °C) | Convector<br>(FCU, 45 °C) | Radiator (45 °C) | Radiator (55 °C) |
|---------------------------|---------------|---------------------------|------------------|------------------|
| Floor (35 °C)             | ○             | X                         | X                | X                |
| Convector<br>(FCU, 45 °C) | ○             | ○                         | ○                | X                |
| Radiator (45 °C)          | ○             | ○                         | ○                | ○                |
| Radiator (55 °C)          | ○             | ○                         | ○                | ○                |

#### [Install Guide 2<sup>nd</sup> Circuit Cooling]

| Main Zone<br>Add. Zone | Floor (18 °C) | Radiator(18 °C) | Convector<br>(FCU, 5 °C) |
|------------------------|---------------|-----------------|--------------------------|
| Floor (18 °C)          | ○             | ○               | X                        |
| Radiator(18 °C)        | ○             | ○               | X                        |
| Convector (FCU, 5 °C)  | X             | X               | ○                        |

※ To use a floor combination during cooling operation, the flow through the floor of the flow must be blocked by the 2 way valve.

**- For 4 Series****[Install Guide 2<sup>nd</sup> Circuit Heating]**

| Circuit 1 \ Circuit 2  | Floor (35°C) | Convector (FCU, 45 °C) | Radiator (45 °C) | Radiator (55 °C) |
|------------------------|--------------|------------------------|------------------|------------------|
| Floor (35 °C)          | ○            | ○                      | ○                | ○                |
| Convector (FCU, 45 °C) | ○            | ○                      | ○                | ○                |
| Radiator (45 °C)       | ○            | ○                      | ○                | ○                |
| Radiator (55 °C)       | ○            | ○                      | ○                | ○                |

**[Install Guide 2<sup>nd</sup> Circuit Cooling]**

| Circuit 1 \ Circuit 2 | Floor (18 °C) | Convector (FCU, 5 °C) |
|-----------------------|---------------|-----------------------|
| Floor (18 °C)         | ○             | ○                     |
| Convector (FCU, 5 °C) | ○             | ○                     |

\* To use a floor combination during cooling operation, the flow through the floor of the flow must be blocked by the 2 way valve.

**NOTE**

Circuit 1 = Direct circuit : Zone where the water temperature is lowest when heating

Circuit 2 = Mixing circuit : The other zone

## How to Wire 2nd Circuit

### - For 3 Series

Follow below procedures Step 1 ~ Step 3.

**Step 1.** Uncover front cover of the unit.

**Step 2.** Find terminal block and connect wire as below

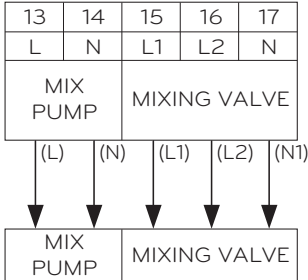

(L) : Live signal from PCB to mix pump

(N) : Neutral signal from PCB to mix pump

(L1) : Live signal (for Normal\* Closed type) from PCB to mixing valve

(L2) : Live signal (for Normal Open type) from PCB to mixing valve

(N1) : Neutral signal from PCB to mixing valve

\*Closed = NOT Mixed

※ The terminal block connection number may differ depending on the model. Refer to the "Wiring Diagram" in the SVC Manual.

**Step 3.** Insert the temperature sensor to 'CN\_MIX\_OUT' (Brown) of the main PCB as shown below. The sensor should be mounted correctly to outlet pipe of mix kit water pump as shown below.

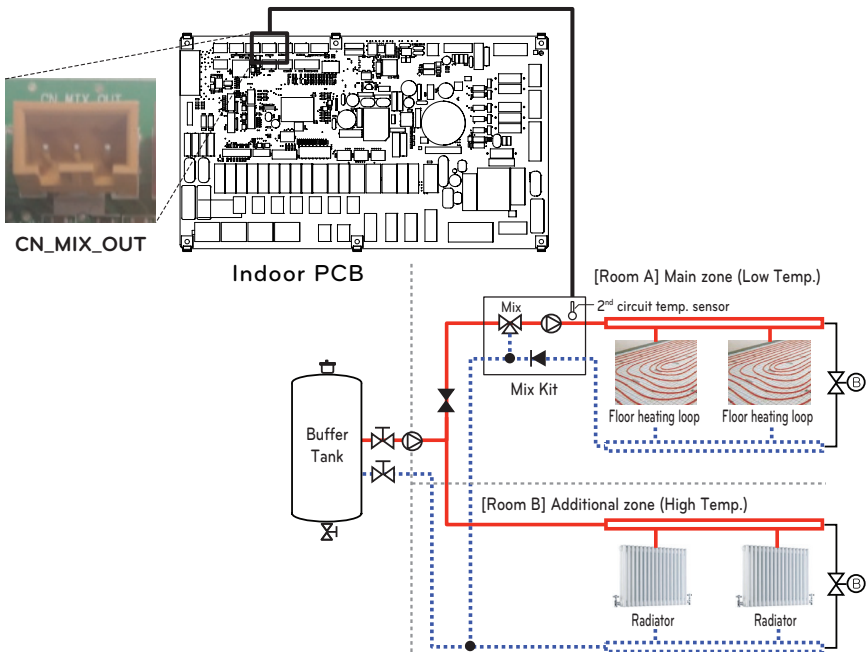

## How to Wire Mix Pump, Mixing Valve and Thermistor for 2nd Circuit

### - For 4 Series

Follow below procedures Step 1 ~ Step 3.

**Step 1.** Uncover front cover of the unit.

**Step 2.** Find terminal block and connect wire as below

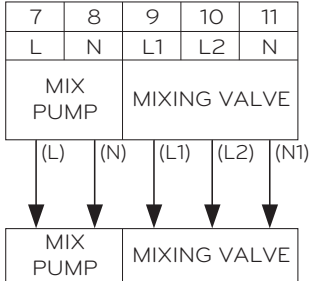

- (L) : Live signal from PCB to mix pump
- (N) : Neutral signal from PCB to mix pump
- (L1) : Live signal (for Normal\* Closed type) from PCB to mixing valve
- (L2) : Live signal (for Normal Open type) from PCB to mixing valve
- (N1) : Neutral signal from PCB to mixing valve

\*Closed = NOT Mixed

**Step3.** Insert the temperature sensor to 'CN\_MIX\_OUT' (Brown) of the main PCB as shown below. The sensor should be mounted correctly to outlet pipe of mix kit water pump as shown below.

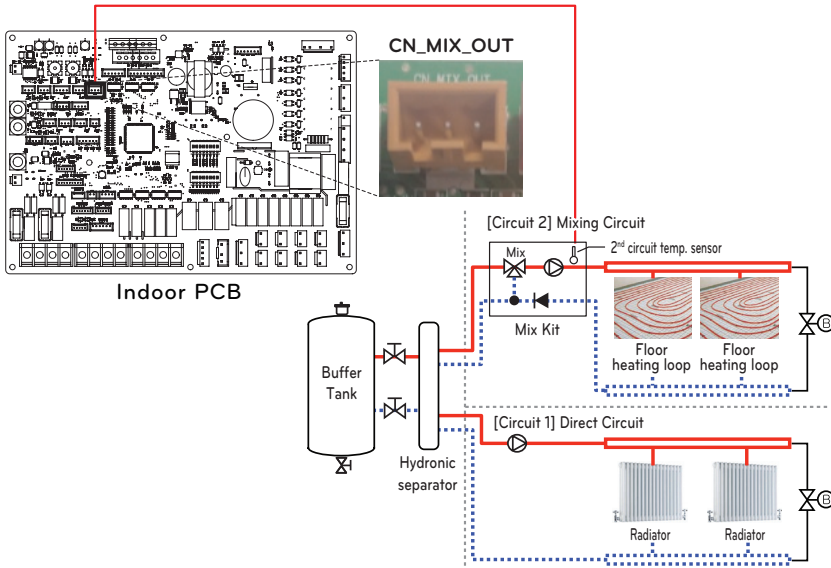

### NOTE

Temperature sensor specification:

Type : Thermistor,NTC

Resistance at 25 °C : 5 kΩ

Minimum operating temperature range : -30 °C~100 °C

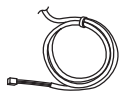
[Thermistor for 2<sup>nd</sup> circuit]

Sensor



Sensor Holder



Sensor Connector

Follow below procedures step 1 ~ step 4.

**Step 1.** Install sensor connector to outlet pipe of mix kit water pump.

(Welding must be performed to connect the sensor connector to the pipe.)

**Step 2.** Check if the power of the unit is turned off.

**Step 3.** Fasten the sensor connector to the sensor holder as shown in the figure below.

**Step 4.** Insert harness into PCB(CN\_TH4) fully and fix the thermal sensor into tube connector as shown below.

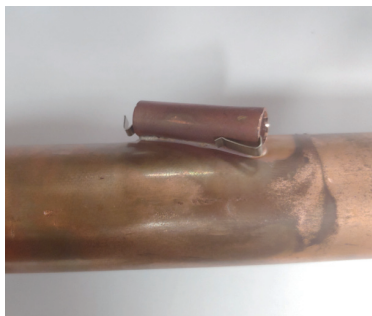

## 3rd Party Boiler

The product can be used by connecting an Auxiliary boiler. You can control the boiler automatically and manually by comparing the outside temperature and the set temperature.

### How to install 3rd party boiler

Follow below procedures step 1 ~ step 3.

**Step 1.** Check if the power of the unit is turned off.

**Step 2.** Disassemble front panels and Distinguish terminal block in Indoor PCB.

**Step 3.** Connect Power cable to terminal block (TB\_BOILER) fully.

- For 3 Series

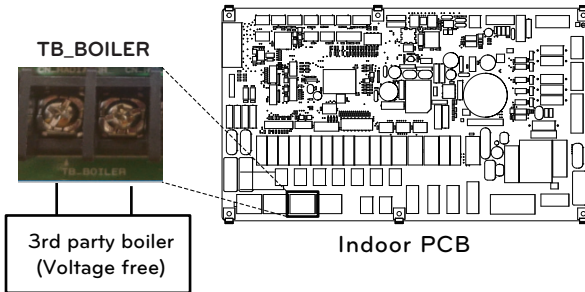

- For 4 Series

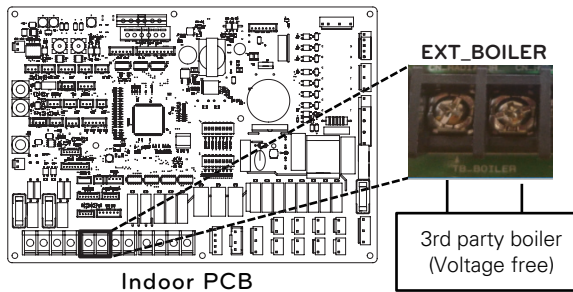

## 3rd Party Controller

The product can also be linked to 3rd party controller. You can connect external controllers using Modbus protocol except for LG controller. If 3rd party controller is used, LG controller is not applied to AWHP simultaneously.

### How to install 3<sup>rd</sup> party controller

Follow below procedures step 1 ~ step 4.

- Step 1.** Check if the power of the unit is turned off.
- Step 2.** Disassemble front panels and distinguish control box(Indoor) of the unit.
- Step 3.** Check if the harness(White) is inserted fully to the indoor unit PCB (CN\_COM).
- Step 4.** Connect the 3rd party controller to terminal block 2(1/1/2) completely. (including Meter interface module)

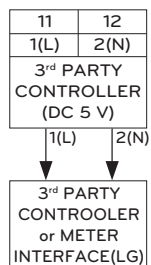

- For 3 Series

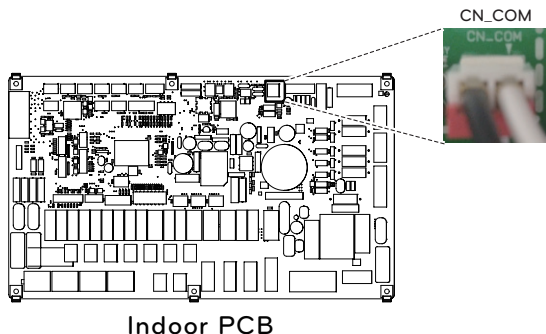

- For 4 Series

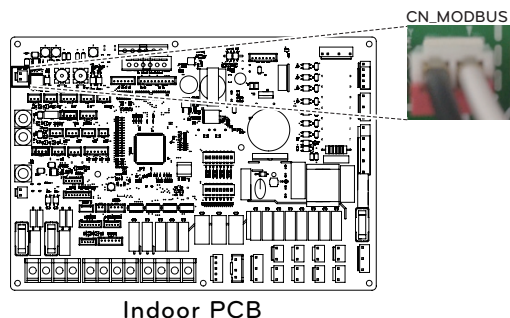

## Meter Interface

This product can be used by connecting the meter interface module supplied in the field. The meter interface module can communicate with the wired remote controller. The meter interface module lets you know the amount of power generated by the product.

### How to install Meter Interface

#### [Parts of Meter interface]

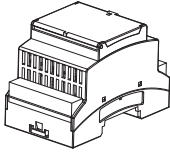

Meter interface body

Follow below procedures step 1 ~ step 4.

**Step 1.** Check if the power of the unit is turned off.

**Step 2.** Disassemble front panels and Distinguish control box(Indoor) of the unit.

**Step 3.** Check if the harness(White) is inserted fully to the indoor unit PCB (CN\_COM).

**Step 4.** Connect the external pump to terminal block 2(11/12).

#### - For 3 Series

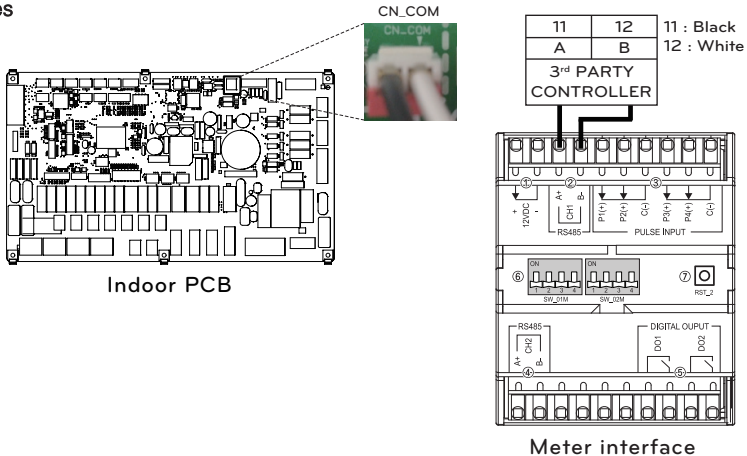

#### - For 4 Series

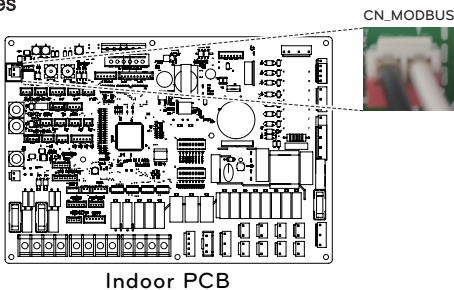

## Central Controller

The product can communicate and control through the central controller. The following functions can be controlled in the central control linked state (Operation/Stop, Desired temperature, Hot water operation / stop, Warm water temperature, Full lock, Etc)

### How to Install Central Controller

To use central controller, you need to establish an environment for mutual communication between central controller and the THERMA V and register the corresponding devices through the functions of central controller. To use central controller, it shall be installed in the following order.

**Step 1.** Installation environment inspection and device address setting

Before installing central controller, check the network for any interfacing devices and assign non overlapping addresses to the connected devices.

**Step 2.** PI485 setting

Install PI485 and set the DIP switch accordingly.

**Step 3.** Connections

Connect PI485 and central controller through RS-485 cable.

**Step 4.** Access and Device Registration

Log in to central controller and register device with address set.

Consult a qualified engineer/ technician for the installation of central controller. If you have any installation queries, contact the LG service center or LG Electronics.

### How to Installation PI485

Fix the PI485 PCB as shown in below images.

For detailed installation method refer to PI485 Installation Manual

UN60A (9, 12, 14, 16 kW)

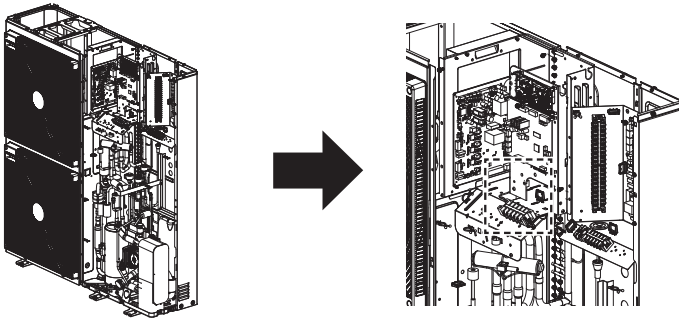

UN36A (5, 7, 9 kW)

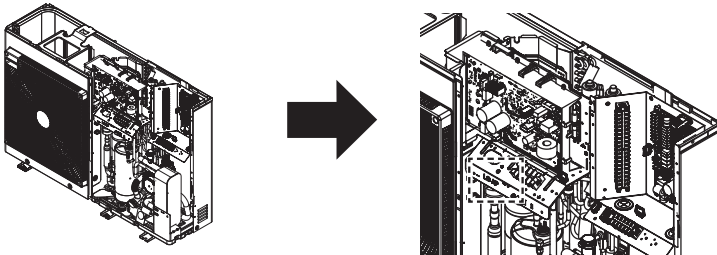

- For detailed installation instructions, refer to the manual included in the accessories.
- The shape may differ depending on the model.

## Remote Controller

### Installation of Remote Controller

- After fixing the remote controller installation plate on the desired location, fix it firmly with the provided screws.
  - If the installation plate is not flat on the surface, it may result in the controller being twisted and cause a defect.
  - If there is a mounting box, install the remote controller installation plate using the fixings holes which suit, as in the below diagrams.
  - Do not leave a gap with the wall or product loose after the installation.

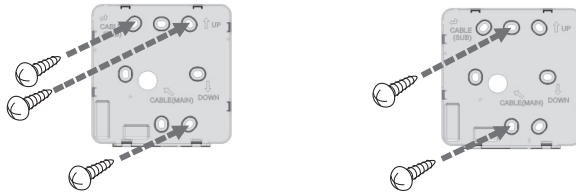

- The wired remote controller cable can be installed in 3 directions. Install to the suitable direction according to the installation environment.
  - Installation direction: Rear entry, top side, right side
  - When you install the remote controller cable at the top side and right side, remove the remote controller cable guide hole before the installation.
    - ※ Use a long nose pliers to remove the guide hole.
- After removing the hole, trim the cut surface neatly.

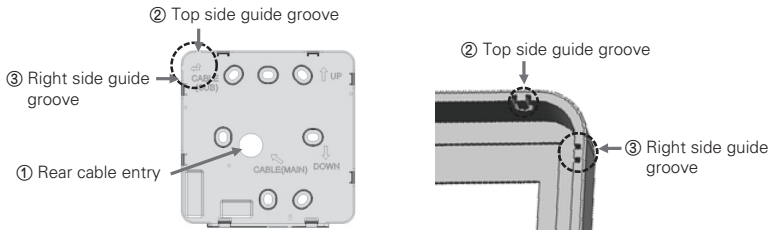

- After fixing the remote controller top side on the installation plate attached to the wall as in the following figure, press the bottom side to combine with the installation plate.
  - Do not leave a gap in the top, bottom, left, and right side of the remote controller and the installation plate after combining them.
  - Before combining with the installation plate, arrange the cables to avoid interference with the circuit parts.

#### <Order of Combining>

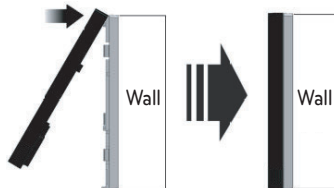

- When you remove the remote controller from the installation plate, insert a small flat head screwdriver into the bottom side separation hole and turn clockwise to separate the remote controller.
  - There are 2 separation holes at the bottom part. Slowly separate one by one.
  - Be careful not to damage the internal parts during the removal.

### <Order of Separation>

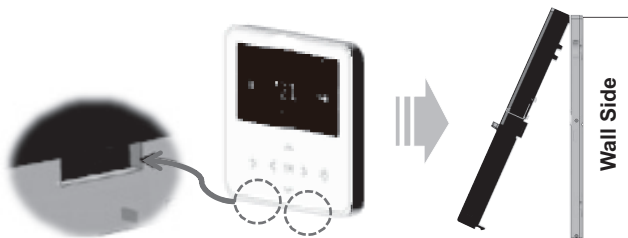

- Use the connection cables to connect the indoor unit with the remote controller.

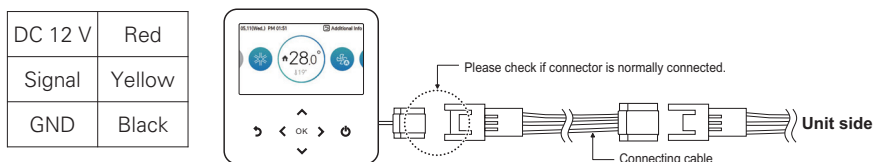

- For the following cases, separately purchase and use the cables suitable for the situation.
  - Do not install the cable over 50 m. (It may cause communication issues.)
  - If the distance between the wired remote controller and the unit is 10 m or more : 10 m extension cable (model name: PZCWRC1)

### NOTE

During the wired remote controller installation, do not bury it in the wall. (It may cause temperature sensor failure.)

Do not install the cable over 50 m. (It may cause communication defect.)

When you install the extension cable, carefully check the direction of the connectors on the remote controller side and the product side before the installation.

Specification of extension cable: AWG 24, 3 conductor or above.

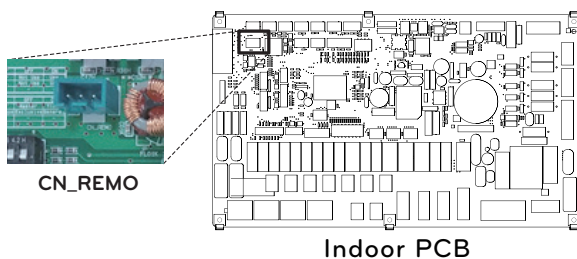

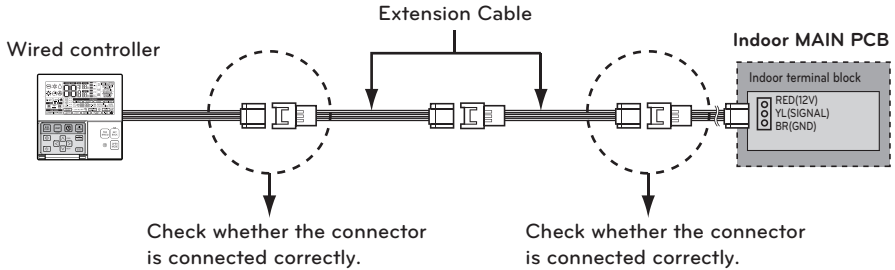

## Cable connection method to use external device

### 1) Wired remote controller-cable connection method.

- In the wired remote controller, connect the part marked in the following figure (J02C, DO-Port) to the cable.
- According to the installation environment, there are 3 directions (Rear entry, top side, and right side) for the installation.

### 2) Cable extension connection method

- Among the cables connected to the wired remote controller, cut the remaining connectors on the other side, and then extend and connect the cables
- Extension cable specification: 24~26 AWG.

## ! CAUTION

For the External device connection, use the cable insulated with sheath for the extension connection.

Before combining with the installation plate, arrange the cables to avoid interference with the internal parts.

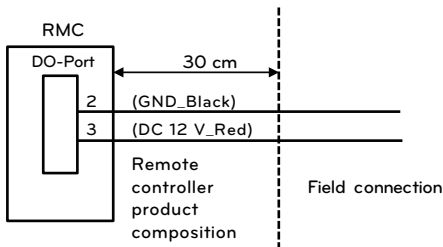

- Output specification
  - Voltage : DC 11~12 V
  - Current : 5 mA

## DHW Tank

To establish DHW circuit, 3way valve and DHW tank kit is required. If solar thermal system is pre-installed at the installation field, solar thermal kit is required to interface solar thermal system – to – DHW tank – to – **THERMAV.**

### Installation condition

Installing DHW water tank requires following considerations :

- DHW water tank should be located at the flat place.
- Water quality should be complied with EN 98/83 EC directives.
- As this water tank is DHW water tank (indirect heat exchange), do not use anti water-freezing treatment like ethylene glycol.
- It is highly recommend to wash out inside of the DHW water tank after installation. It ensures generating clean hot water.
- Near the DHW water tank there should be water supply and water drain to easy access and maintenance.
- Set the maximum value of the temperature control device of DHW tank.

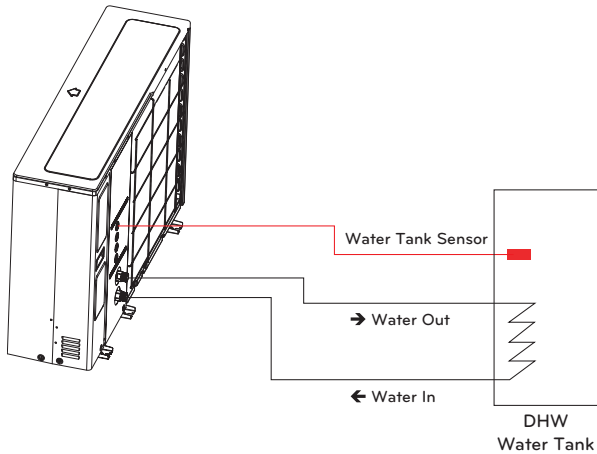

### General Information

**THERMAV.** supports following 3way valve.

| Type                      | Power    | Operating Mode   | Supported |
|---------------------------|----------|--|-----------|
| SPDT <sup>1)</sup> 3-wire | 230 V AC | Selecting Flow A <sup>2)</sup> between Flow A and Flow B | Yes       |
|                           |          | Selecting Flow B <sup>3)</sup> between Flow A and Flow B | Yes       |

1. SPDT = Single Pole Double Throw. Three wires consist of Live1 (for selecting Flow A), Live 2 (for selecting Flow B), and Neutral (for common).
2. Flow A means water flow from the unit to under floor water circuit.
3. Flow B means water flow from the unit to DHW tank.

## Installing recirculation pump

### - For 3 Series

When **THERMAV** is used with DHW tank, it is **STRONGLY** recommended to install recirculation pump to prevent flooding out cold water at the end of hot water supply and to stabilize the water temperature inside DHW tank

- The recirculation pump should be operated when DHW demand is not required. Therefore, external time scheduler to determine when the recirculation pump should turn on and turn off is required.

- The operating duration time of the recirculation pump is calculated as follow :

$$\text{Duration time [minute]} = k \times V \times R$$

k : 1.2 ~ 1.5 is recommended. (If distance between pump and tank is far, then choose high number)

V : Volume of DHW water tank [liter]

R : Water flow rate of pump [liter per minute], which is determined by pump performance curve

- The pump operating start time should be prior to the DHW water demand.

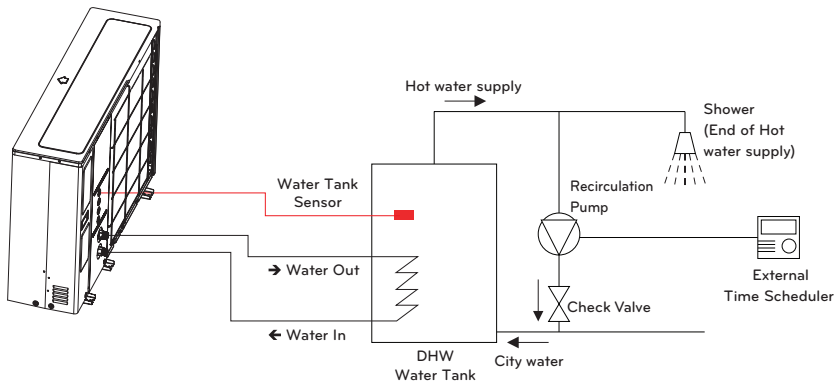

\* Water In / Water Out installation scene may vary depending on the model.

## Installing recirculation pump

### - For 4 Series

When **THERMAV** is used with DHW tank, it is **STRONGLY** recommended to install recirculation pump to prevent flooding out cold water at the end of hot water supply and to stabilize the water temperature inside DHW tank

- The recirculation pump should be operated when DHW demand is not required. Therefore, external time scheduler to determine when the recirculation pump should turn on and turn off is required.

- The operating duration time of the recirculation pump is calculated as follow :

$$\text{Duration time [minute]} = k \times V \times R$$

k : 1.2 ~ 1.5 is recommended. (If distance between pump and tank is far, then choose high number)

V : Volume of DHW tank [liter]

R : Water flow rate of pump [liter per minute], which is determined by pump performance curve.

- The pump operating start time should be prior to the DHW demand.

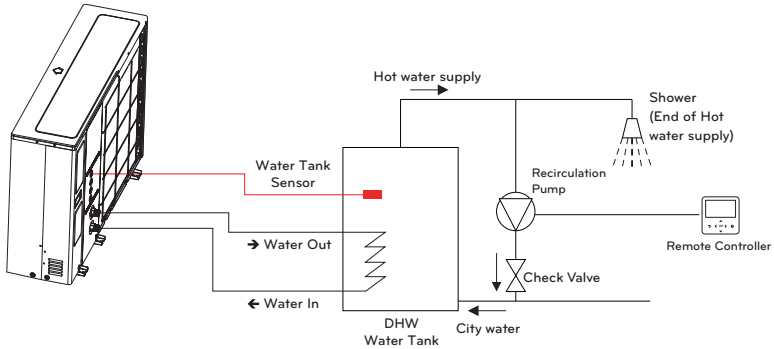

\* Water In / Water Out installation scene may vary depending on the model.

### NOTE

- For more information about recirculation pump, Please refer chapter 8 and chapter 9 of **THERMAV** installation manual and owners manual.

### How to wire recirculation pump

Follow below procedures step 1 ~ step 4.

**Step 1.** Check if the power of the unit is turned off.

**Step 2.** Disassemble front panels and distinguish control box(Indoor) of the unit.

**Step 3.** Check if the harness(Violet) is inserted fully to the indoor unit PCB (CN\_PUMP\_A15).

**Step 4.** Connect the DHW recirculation pump to terminal block 1(3/4).

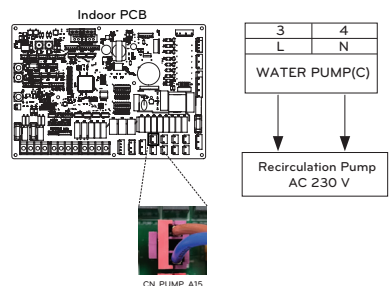

## How to Wire Booster Heater

**Step 1.** Uncover heater cover of the DHW tank. It is located side of the tank.

**Step 2.** Find terminal block and connect wires as below. Wires are field-supplied item.

(L) : Live signal from PCB to Heater.

(N) : Neutral signal from PCB to Heater.

### ⚠ WARNING

Wire specification

- Cross-sectional area of the wire should be 6 mm<sup>2</sup>.

Adjusting thermostat temperature

- To guarantee proper operation, it is recommended to set temperature of thermostat to maximum temperature (symbol **A** at the picture).
- 1Ø Backup Heater Model and 3Ø Backup Heater Model are set by same method as below.

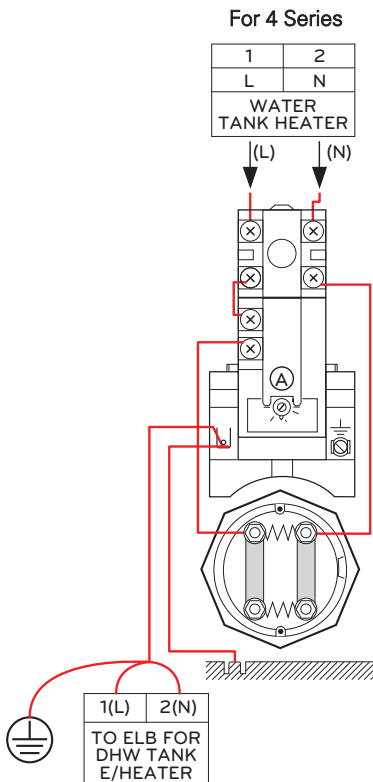

## How to Wire DHW Tank Heater

**Step 1.** Uncover heater cover of the DHW tank. It is located side of the tank.

**Step 2.** Find terminal block and connect wires as below. Wires are field-supplied item.

(L) : Live signal from PCB to Heater

(N) : Neutral signal from PCB to Heater

### ! WARNING

Wire specification

- Cross-sectional area of the wire should be 6 mm<sup>2</sup>.

Adjusting thermostat temperature

- To guarantee proper operation, it is recommended to set temperature of thermostat to maximum temperature (symbol at the picture).
- 1Ø Electric Heater Model and 3Ø Electric Heater Model are set by same method as below.

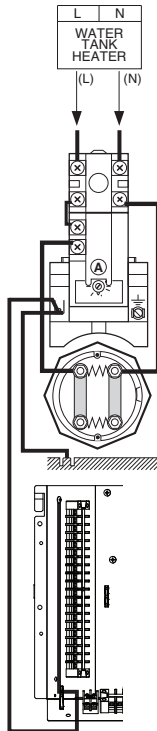

## DHW Tank Kit

This product can be used by connecting the DHW tank kit in the field. It can be utilized hot water heated by booster heater in DHW tank.

### How to install DHW tank kit

#### [Parts of DHW Tank Kit]



Temperature sensor for DHW tank is used to control hot water temperature of DHW tank. If sensor will be defective, you can purchase it separately. (Model name : PHRSTA0)

Follow below procedures step 1 ~ step 4.

**Step 1.** Uncover DHW tank kit and locate it on the wall.

**Step 2.** Connect Harness (Violet) of Main PCB assembly (TB1 (6/7)) to 'CN\_B\_Heat\_A' of the Main PCB like following fig. 1.

**Step 3.** Insert DHW tank sensor to 'CN\_TH4' (Red) of the Main PCB refer as below.

**Step 4.** Connect power supply to the DHW tank kit as shown fig. 1.

\* The sensor should be mounted correctly to the sensor hole of DHW water tank like below fig. 2.

#### - For 3 Series

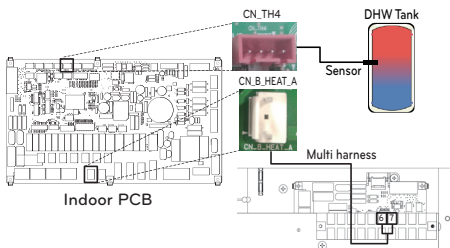

Fig. 1

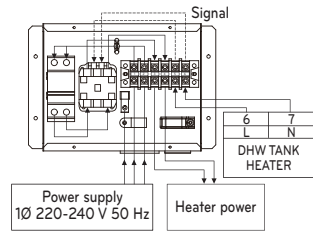
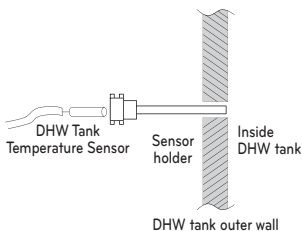

Fig. 3



Insert sensor until the cable tie as shown below.

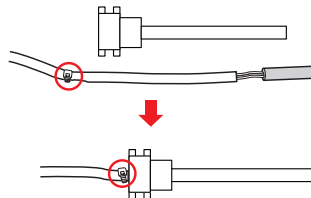
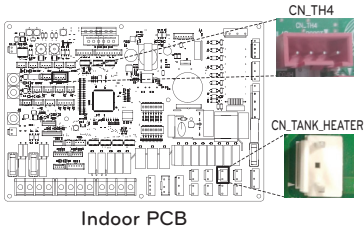

Fig. 2

\* The terminal block connection number may differ depending on the model. Refer to the "Wiring Diagram" in the SVC Manual.

- For 4 Series



Indoor PCB

Fig. 1

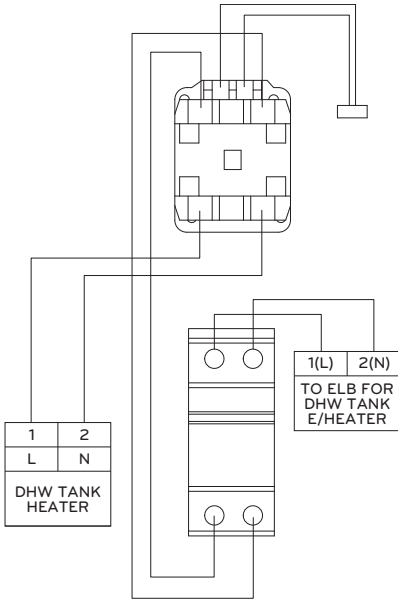

## Solar Thermal Kit

This product can be used by connecting the solar thermal kit in the field. It can be utilized hot water heated by solar thermal system. End-user must be LG AWHP solar thermal kit.

### How to Install Solar Thermal Kit

#### [Parts of Solar Thermal Kit]



Holder sensor

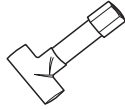

Tube Connector



Solar Thermal Sensor  
12 m(1 EA)

Follow below procedures step 1 ~ step 4.

**Step 1.** Install tube connector(it is necessary to reduce or extend diameter of pipe.) the pipe and solar thermal kit.

**Step 2.** Check if the power of the unit is turned off.

**Step 3.** Disassemble front panels and distinguish control box(Indoor) of the unit.

**Step 4.** Insert harness into PCB(CN\_TH4) fully and fix the thermal sensor into tube connector as shown below.

\* If the DHW tank sensor is connected, disconnect the sensor from PCB first.

#### - For 3 Series

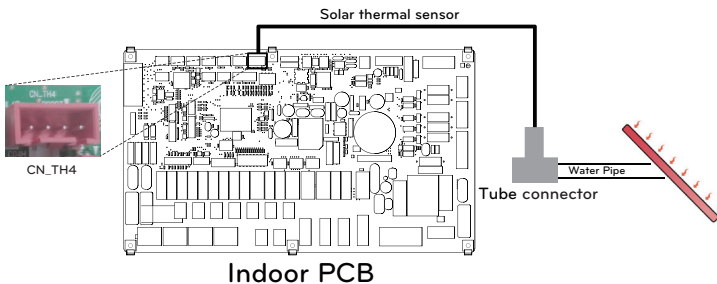

#### - For 4 Series

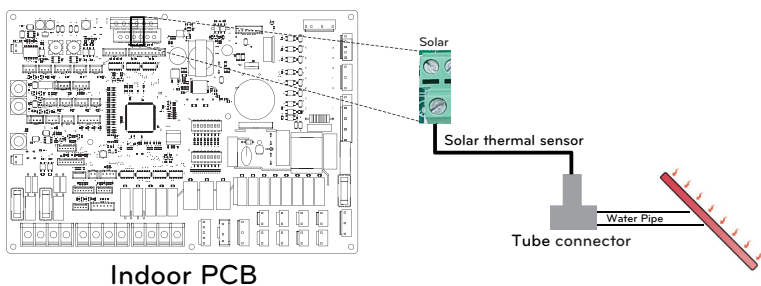

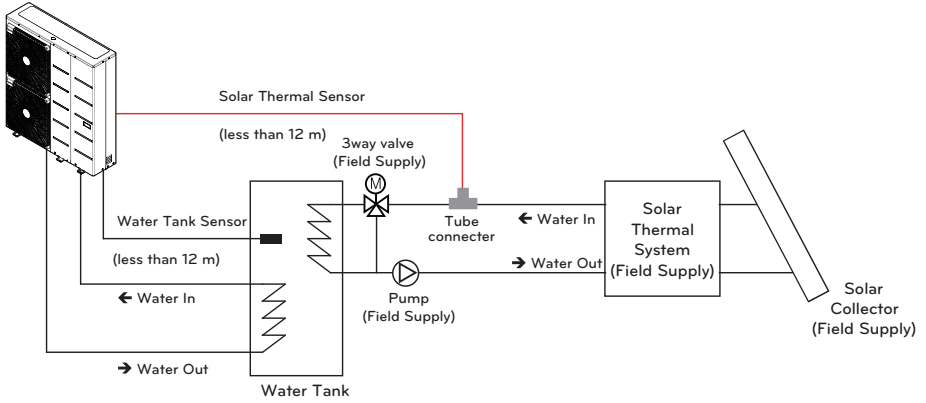

※ Water In / Water Out installation scene may vary depending on the model.

- Insert sensor until the cable tie as shown below.



## CAUTION

Sensor mounting

Insert sensor into sensor socket and bolt it tightly.

## Dry Contact

Dry Contact is a solution for automatic control of HVAC system at the owner's best. In simple words, it's a switch which can be used to turn the unit On/Off after getting the signal from external sources.

### How to install dry contact

#### [Parts of Dry contact]

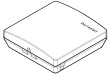

Dry Contact body



Cable(for connecting with IDU)

Follow below procedures step 1 ~ step 4.

**Step 1.** Check if the power of the unit is turned off.

**Step 2.** Disassemble front panels and distinguish terminal block in Indoor PCB.

**Step 3.** Connect cable to the unit PCB(CN\_CC) fully.

**Step 4.** Then, Insert harness to the dry contact PCB(CN\_INDOOR) firmly as shown below.

#### - For 3 Series

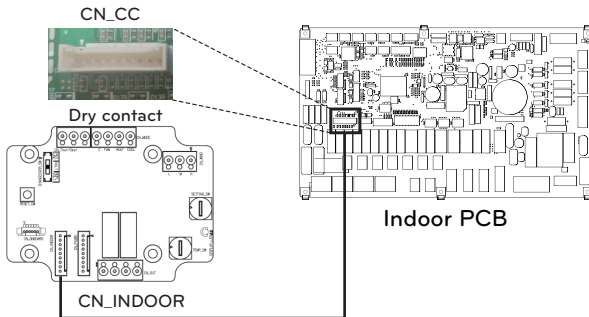

#### - For 4 Series

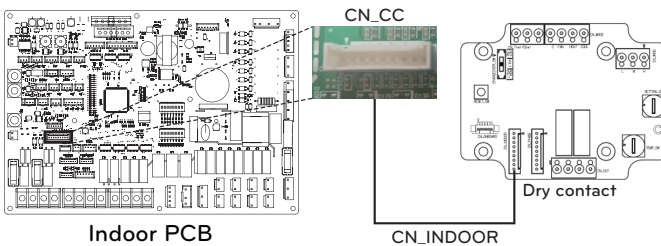

### NOTE

- For more information about installing Dry Contact, Please refer installation manual provided with Dry Contact.
- For system set-up, please read chapter 8 (Accessory Installation) and chapter 9 (DIP Switch setting).

[Setting of Contact Signal Input]

- For input contact closure only (No power input)

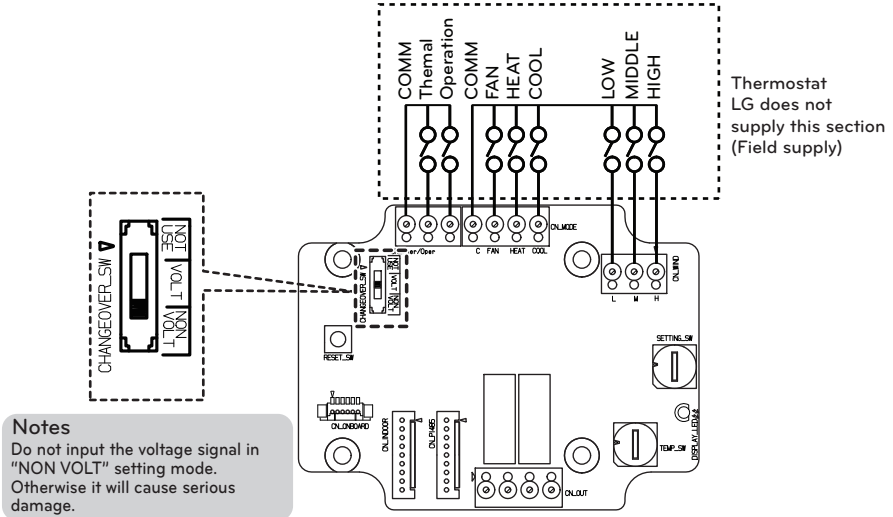

- For input contact voltage : DC 12 V, 24 V~

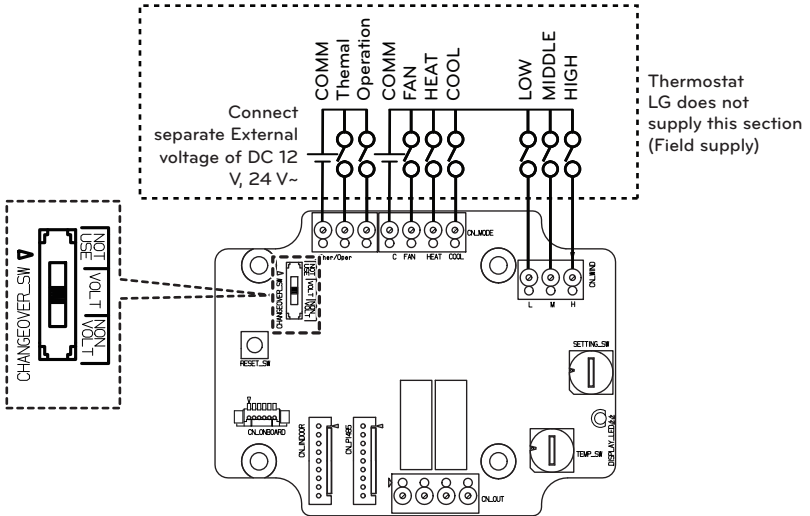

## External Controller - Setting up programmable digital input operation

If you require to operate control depending on external digital input(ON/OFF), connect cable to indoor PCB(CN\_EXT).

Follow below procedures step 1 ~ step 4.

**Step 1.** Check if the power of the unit is turned off.

**Step 2.** Disassemble front panels and distinguish control box(Indoor) of the unit

**Step 3.** Connect the external controller to PCB(CN\_EXT) completely.

**Step 4.** Connect the cable and field installation part.

- For 3 Series

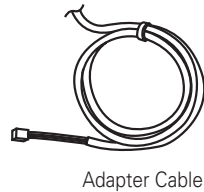
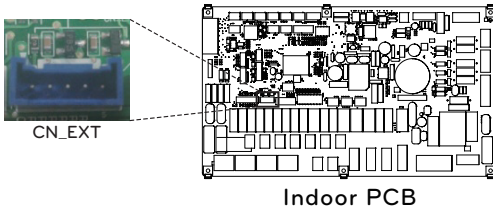

- For 4 Series

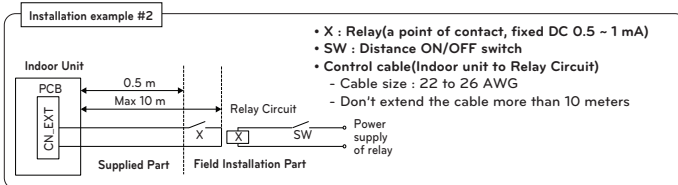
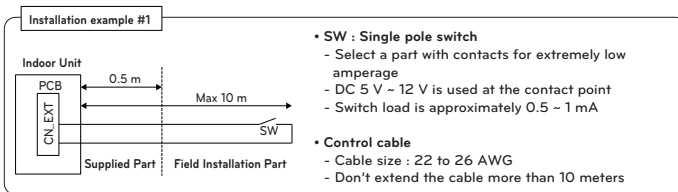
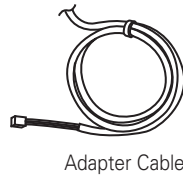
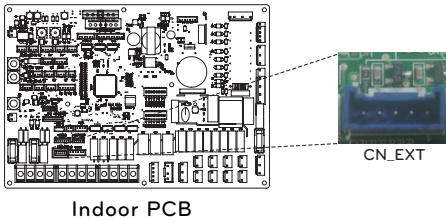

Determining the purpose of CN\_EXT  
Setting value: 0 ~ 5 step Indoor CN-EXT port setting

- 0: default
- 1: Simple operation on / off
- 2: Dry contact (simple contact)

- 3: Emergency stop only for indoor unit
- 4: Reattachment / absence
- 5: Emergency stop of all indoor units (It can be set only when indoor unit has emergency stop function)

## Remote Temperature Sensor

Remote temperature sensor can be installed any place a user wants to detect the temperature.

### Installation condition

Role and constraint while installation of remote air temperature sensor is very similar to that of thermostat.

- Distance between the unit and the remote air temperature sensor should be less than 15 m due to length of the connection cable of remote air temperature sensor.
- For other constraints, please refer to previous page where constraints about thermostat is described

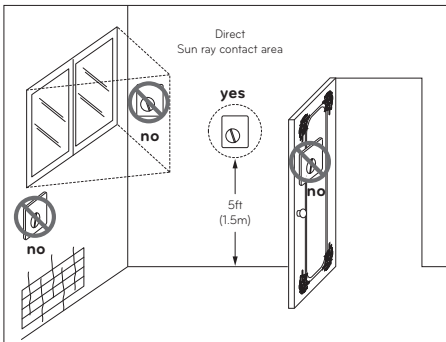

Thermostat

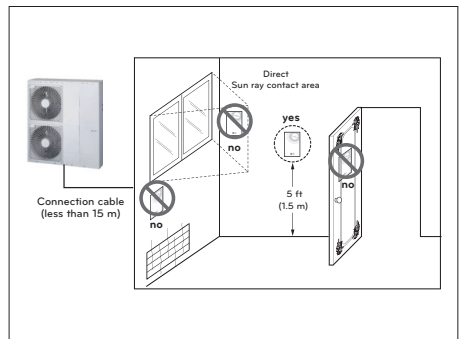

Remote Air Temperature Sensor

## How to Install Remote Temperature Sensor

### [Parts of Remote Temperature Sensor]



Sensor



Screw(to fix remote sensor)

Follow below procedures step 1 ~ step 5.

**Step 1.** Decide where the remote temperature sensor is installed. Then, Determine the location and height of the fixing screws in fig. 1 (Interval between the screws : 60 mm)

**Step 2.** Check if the power of the unit is turned off.

**Step 3.** Disassemble front panels and distinguish control box(Indoor) of the unit.

**Step 4.** Insert temperature sensor into PCB(CN\_ROOM) and fix the sensor firmly in fig. 2.

**Step 5.** The Connection wire does not matter if you change the color of the wire because of nonpolar.

#### - For 3 Series

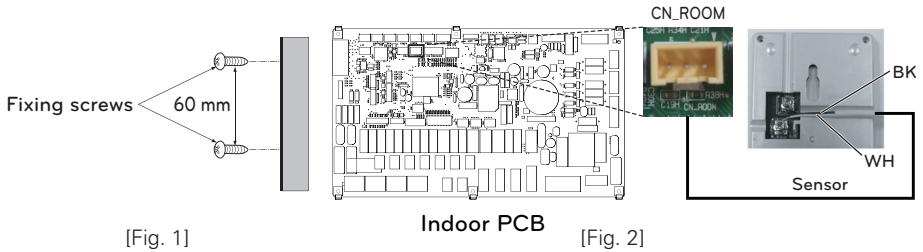

#### - For 4 Series

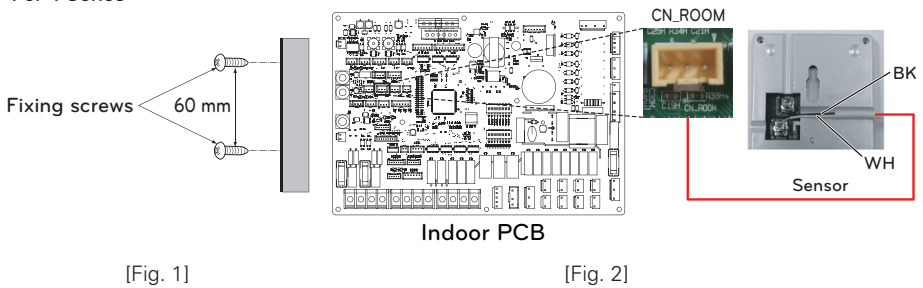

**Step 6.** Integrate the remote temperature sensor with the screws as the order of arrows.

Fixing the Remote Sensor

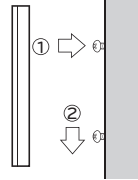

### ! CAUTION

- Choose the place where the average temperature can be measured for the unit operates.
- Avoid direct sunlight.
- Choose the place where the cooling/heating devices do not affect the remote sensor.
- Choose the place where the outlet of the cooling fan do not affect the remote sensor.
- Choose the place where the remote sensor isn't affected when door is open.

### NOTE

- For more information about installing Remote Temperature Sensor, Please refer installation manual provided with Remote Temperature Sensor.
- For system set-up, please read chapter 8.(Especially function code No.3)

## Solar pump

Solar pump can be required to energize water flow when solar thermal system is installed.

### How to install solar pump

Follow below procedures step 1 ~ step 4.

**Step 1.** Check if the power of the unit is turned off.

**Step 2.** Disassemble front panels and distinguish control box(Indoor) of the unit.

**Step 3.** Check if the harness(Black) is inserted fully to the indoor unit PCB (CN\_W\_PUMP\_B).

**Step 4.** Connect the external pump to terminal block 1(4/5).

※ It is possible to un-use solar pump depending on installation environment.

- For 3 Series

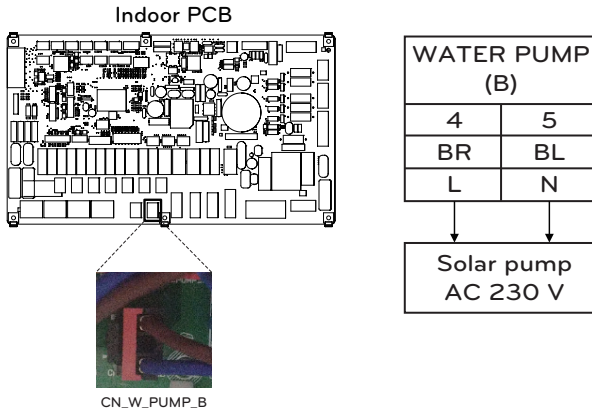

- For 4 Series

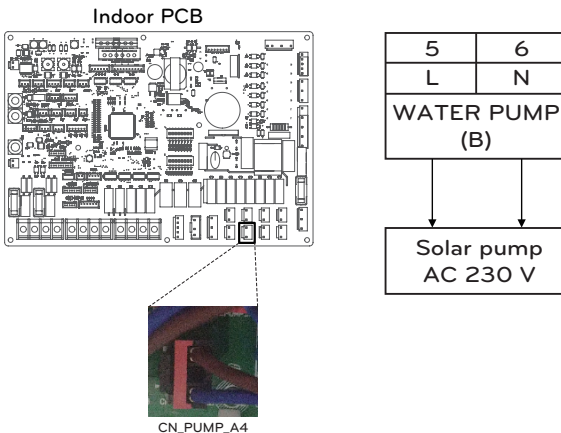

※ The terminal block connection number may differ depending on the model. Refer to the "Wiring Diagram" in the SVC Manual.

## External pump

External pump can be required when the room to take floor heating is too large or not well-insulated.(potential free) Also, External pump is installed with buffer tank to retain sufficient capacity.

### How to install external pump

Follow below procedures step 1 ~ step 3.

**Step 1.** Check if the power of the unit is turned off.

**Step 2.** Disassemble front panels and distinguish terminal block in Indoor PCB.

**Step 3.** Connect signal cable to terminal block (TB\_W\_PUMP\_C) fully.

- For 3 Series

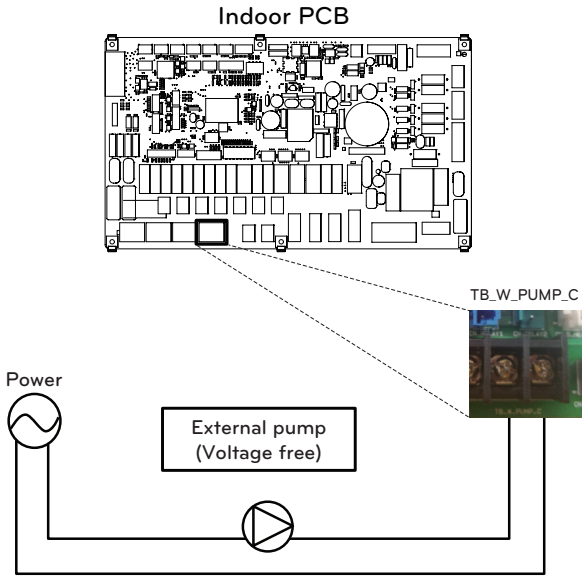

- For 4 Series

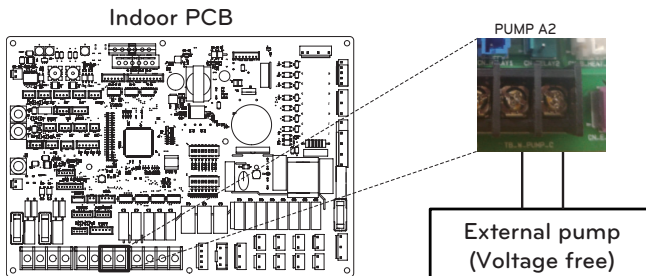

## Wi-fi Modem

Wi-fi modem enables remote system operation from smartphone. Available functions include selection of on/off, operation mode, DHW heating, temperature setup and weekly scheduling etc.

### How to install Wi-fi Modem

[Parts of Wi-fi modem]



Wi-fi modem body

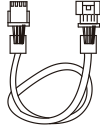

USB Cable

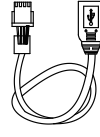

Extension Cable

Follow below procedures step 1 ~ step 5.

**Step 1.** Check if the power of the unit is turned off.

**Step 2.** Disassemble front panels and distinguish control box(Indoor) of the unit.

**Step 3.** Connect the USB cable to the indoor unit PCB (CN\_WF ; Blue) until it clicks into place.

**Step 4.** Connect the Wi-Fi modem to the USB cable fully.

**Step 5.** Refer to the image below to install the Wi-Fi modem in the marked position.

- For 3 Series

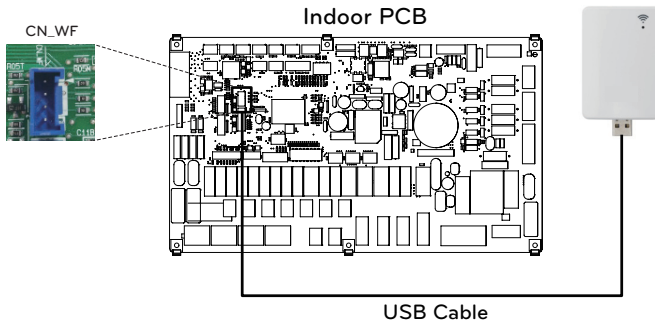

- For 4 Series

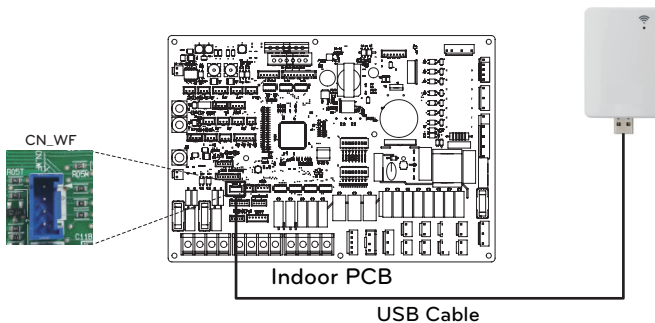

In case of using the extension wire (PWYREW000), fasten the core of extension wire to clamp of the indoor control box.

## Energy State

This product provides energy states that enable customers to use as much as possible of their own renewable energy. It can shift setpoints depending on input signal from Energy Storage System (ESS) or from any other third-party device using Modbus RTU or Digital 230V inputs.

### Available Energy States

There are 8 energy states available. 4 fixed and 4 customizable - each with the possibility to enhance selfconsumption of renewable energy.

| Energy state | Command                      | Battery State of charge | Operation (standard setting)          |                      |                                  |                      |                                       |                       |
|--------------|------------------------------|-------------------------|---------------------------------------|----------------------|----------------------------------|----------------------|---------------------------------------|-----------------------|
|              |                              |                         | Heating                               |                      | Cooling                          |                      | Domestic Hot Water                    |                       |
|              |                              |                         | Setting                               | Range                | Setting                          | Range                | Setting                               | Range                 |
| 1            | Operation Off (Utility lock) | Low                     | Forced internal operation off         | Fixed                | Forced internal operation off    | Fixed                | Forced internal operation off         | Fixed                 |
| 2            | Normal Operation             | Normal                  | Maintain operation status             | Fixed                | Maintain operation status        | Fixed                | Maintain operation status             | Fixed                 |
| 3            | Operation On Recommend       | High                    | Increase 2 °C from target temperature | Fixed                | Maintain operation Status        | Fixed                | Increase 5 °C from target temperature | Fixed                 |
| 4            | Operation On Recommend       | Very High               | Maintain operation status             | Fixed                | Maintain operation status        | Fixed                | DHW Target 80 °C                      | Fixed                 |
| 5            | Operation On Command         | Very High               | Increase from target temperature      | 0/+30 (Default : +5) | Decrease from target temperature | 0/-30 (Default : -5) | Increase from target temperature      | 0/+50 (Default : +30) |
| 6            | Operation On Recommend       | High                    | Increase from target temperature      | 0/+30 (Default : +2) | Decrease from target temperature | 0/-30 (Default : -2) | Increase from target temperature      | 0/+50 (Default : +10) |
| 7            | Operation Save               | Low                     | Decrease from target temperature      | 0/-30 (Default : -2) | Increase from target temperature | 0/+30 (Default : +2) | Decrease from Target Temperature      | 0/-50 (Default : 0)   |
| 8            | Operation Super Save         | Very Low                | Decrease from target temperature      | 0/-30 (Default : -5) | Increase from target temperature | 0/+30 (Default : +5) | Decrease from Target Temperature      | 0/-50 (Default : 0)   |

## Digital Input for energy saving (ESS, Smart Grid)

This product provides two digital inputs (TB\_SG1 / TB\_SG2) that can be used to switch between energy states when not using Modbus RTU (CN-COM).

### Available Energy States

There are 8 energy states available in total. Four different states can be triggered using the 230V-inputs – by default Energy states 1-4.

With the digital input assignment in the menu 'Energy state/Digital input assignment' of the control pane, different Energy states can be selected for Signals 0:1 and 1:1.

0:0 is always linked with ES2 (Normal operation) and 1:0 is always linked with ES1 (Operation off/Utility lock).

### How to set Digital input signal

Follow below procedures step 1 ~ step 3.

**Step 1.** Check if the power of the unit is turned off.

**Step 2.** Disassemble front panels and distinguish terminal block in Indoor PCB.

**Step 3.** Connect signal cable to terminal block in PCB (TB\_SG2, TB\_SG1) fully as shown below.

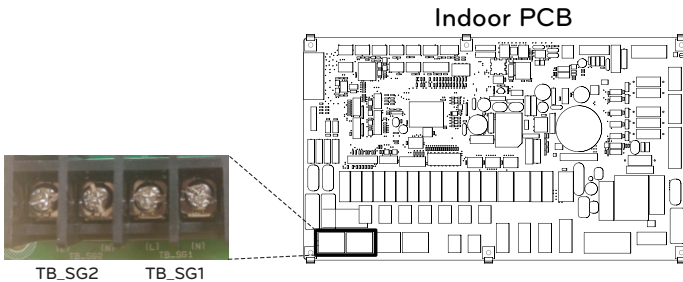

### Energy state depending on input signal (TB\_SG1/TB\_SG2)

| Input Signal |        | Output state |         |
|--------------|--------|--------------|---------|
| TB_SG1       | TB_SG2 | Default      | Range   |
| 0            | 0      | ES2          | fixed   |
| 1            | 0      | ES1          |         |
| 0            | 1      | ES3          | ES3-ES8 |
| 1            | 1      | ES4          |         |

## 2Way Valve

2way valve is required to control water flow while cooling operation. Role of 2way valve is to cut off water flow into under floor loop in cooling mode when fan coil unit is equipped for cooling operation.

### General Information

**THERMAV.** supports following 2way valve.

| Type                    | Power    | Operating Mode     | Supported |
|-------------------------|----------|--------------------|-----------|
| NO 2-wire <sup>1)</sup> | 230 V AC | Closing water flow | Yes       |
|                         |          | Opening water flow |           |
| NC 2-wire <sup>2)</sup> | 230 V AC | Closing water flow | Yes       |
|                         |          | Opening water flow |           |

1. Normal Open type. When electric power is NOT supplied, the valve is open. (When electric power is supplied, the valve is closed.)
2. Normal Closed type. When electric power is NOT supplied, the valve is closed. (When electric power is supplied, the valve is open.)

### How to Wire 2Way Valve

Follow below procedures Step 1 ~ Step 2.

**Step 1.** Uncover front cover of the unit.

**Step 2.** Find terminal block and connect wire as below.

- For 3 Series

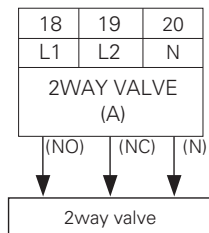

- For 4 Series

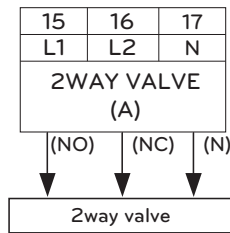

### CAUTION

Dew Condensation

- Wrong wiring can yield dew condensation on the floor. If radiator is connected at the under floor water loop, dew condensation can be occurred on the surface of the radiator.

### WARNING

Wiring

- Normal Open type should be connected to wire (NO) and wire (N) for valve opening in cooling mode.
- Normal closed type should be connected to wire (NC) and wire (N) for valve closing in cooling mode.

(NO) : Live signal (for Normal Open type) from PCB to 2way valve  
(NC) : Live signal (for Normal Closed type) from PCB to 2way valve  
(N) : Neutral signal from PCB to 2way valve

※ The terminal block connection number may differ depending on the model. Refer to the "Wiring Diagram" in the SVC Manual.

### Final Check

- Flow direction :
  - Water should not flow into under floor loop in cooling mode.
  - To verify the flow direction, check temperature at the water inlet of the under floor loop.
  - If correctly wired, this temperatures should not be approached to 6 °C in cooling mode.

## 3Way Valve(A)

3Way Valve(A) is required to operate DHW water tank. Role of 3way valve is flow switching between under floor heating loop and water tank heating loop. Plus, it is required to operate 3<sup>rd</sup> party boiler.

### General Information

**THERMAV.** supports following 3way valve.

| Type                         | Power      | Operating Mode  | Supported |
|------------------------------|------------|---|-----------|
| SPDT<br>3-wire <sup>1)</sup> | 220-240 V~ | Selecting Flow A <sup>2)</sup> between<br>Flow A and Flow B | Yes       |
|                              |            | Selecting Flow B <sup>3)</sup> between<br>Flow A and Flow B | Yes       |

1. SPDT = Single Pole Double Throw. Three wires consist of Live1 (for selecting Flow A), Live 2 (for selecting Flow B), and Neutral (for common).
2. Flow A means 'water flow from the unit to under floor water circuit.'
3. Flow B means 'water flow from the unit to DHW water tank.'

### How to wire 3way valve(A)

Follow below procedures Step 1 ~ Step 2.

Step 1. Uncover front cover of the unit.

Step 2. Find terminal block and connect wire as below.

- For 3 Series

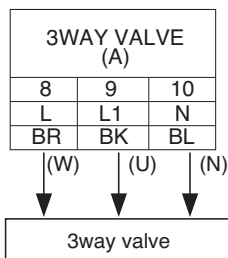

- For 4 Series

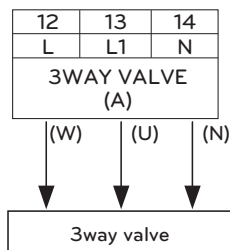

### ⚠ WARNING

- 3way valve should select water tank loop when electric power is supplied to wire (W) and wire (N).
- 3way valve should select under floor loop when electric power is supplied to wire (U) and wire (N).

(W) : Live signal (Water tank heating) from PCB to 3way valve

(U) : Live signal (Under floor heating) from PCB to 3way valve

(N) : Neutral signal from PCB to 3way valve

※ The terminal block connection number may differ depending on the model. Refer to the "Wiring Diagram" in the SVC Manual.

## 3Way Valve(B)

3way valve(B) is required to operate Solar thermal system. Role of 3way valve is flow switching between open and close mode of the solar circuit.

### General Information

**THERMA V.** supports following 3way valve.

| Type                         | Power      | Operating Mode  | Supported |
|------------------------------|------------|---|-----------|
| SPDT<br>3-wire <sup>1)</sup> | 220-240 V~ | Selecting Flow A <sup>2)</sup> between<br>Flow A and Flow B | Yes       |
|                              |            | Selecting Flow B <sup>3)</sup> between<br>Flow A and Flow B | Yes       |

1. SPDT = Single Pole Double Throw. Three wires consist of Live1 (for selecting Flow A), Live 2(for selecting Flow B), and Neutral (for common).
2. Flow B means 'heat source toward solar panel repeatedly'. (close mode of circuit)
3. Flow A means 'heat source flow from solar panel to DHW tank in solar circuit'. (open mode of circuit)

### How to wire 3way valve(B)

Follow below procedures Step 1 ~ Step 2.

Step 1. Uncover front cover of the unit.

Step 2. Find terminal block and connect wire as below.

#### - For 3 Series

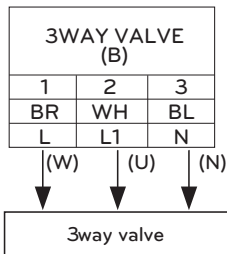

#### - For 4 Series

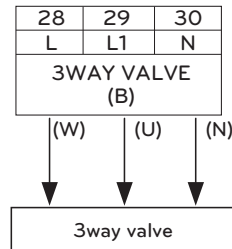

## ! WARNING

- 3way valve should select "close solar circuit" when electric power is supplied to wire (W) and wire (N).
- 3way valve should select "open solar circuit" when electric power is supplied to wire (U) and wire (N).

(W) : Live signal (close solar circuit) from PCB to 3way valve

(U) : Live signal (open solar circuit) from PCB to 3way valve

(N) : Neutral signal from PCB to 3way valve

\* The terminal block connection number may differ depending on the model. Refer to the "Wiring Diagram" in the SVC Manual.

## Electric Heater

### How to Pipe Electric Heater

Follow below procedures Step 1 ~ Step 4.

**Step 1.** Uncover the electric heater accessory.

**Step 2.** Check the diameter of pre-installed pipes of unit.

**Step 3.** If the diameter of pre-installed pipes is different from diameter of electric heater accessory kit, it is necessary to reduce or expand pipe's diameter.

**Step 4.** Connect the pipes. The inlet pipe of electric heater accessory must be connected to outlet of the unit.

### WARNING

Followings should be kept before installation

- The unit should be stop before the piping work.
- Never connect electric power while piping electric heater.
- Before the piping working, water in the part(or to heating loop) installed with electric heater should be drained. After working, water should be charged.

### CAUTION

- Electric Heater should be installed with enough space for installation and service.
- Water pipes and connections should be cleaned using water.
- Methods to prevent leakage in plumbing connections must be applied.
- Heater must not be impacted.
- Do not let dirty particle be dropped inside tank to avoid possibility of degrade.
- After installation, make it sure that no leakage is appeared in the connection.

## Terminal Block Information

Symbols used below pictures are as follows :

- L, L1, L2 : Live (220-240 V~)
- N : Neutral (220-240 V~)
- BR : Brown, WH : White, BL : Blue, BK : Black

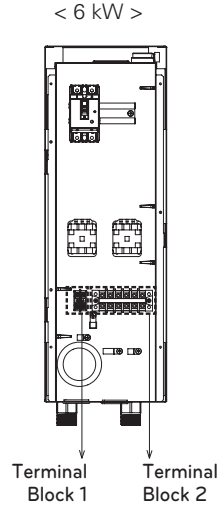
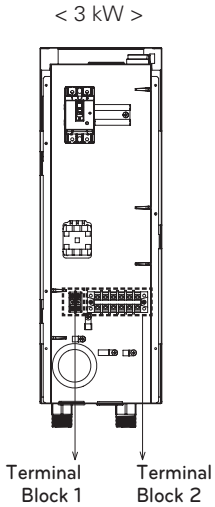

## How to Wire Electric Heater

### - For 3 Series

Follow below procedures Step 1 ~ Step 4.

**Step 1.** Uncover the electric heater accessory.

**Step 2.** Find the terminal block and connect wires. Refer to the installation manual of the electric heater. (Wires are field-supplied item.)

**Step 3.** Connect terminal block ports unit and electric heater accessory.

- HAETER(A) : Signal to activate 1st step

- HEATER(B) : Signal to activate 2nd step

#### (3 kW) Terminal Block 2 (In Backup Heater)

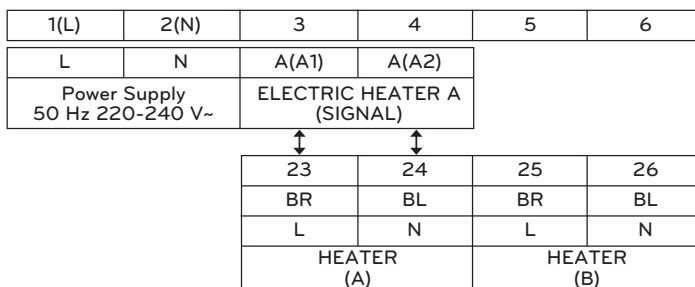

Terminal Block 3 (In Unit)

#### (6 kW) Terminal Block 2 (In Backup Heater)

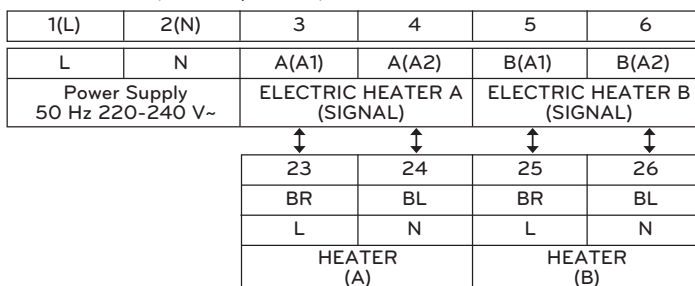

Terminal Block 3 (In Unit)

**Step 4.** Connect power supply cable to terminal block 2.

When Tightening the power cable on terminal block, Be careful to prevent a shock or injury. (AC 220-240 V signal)

#### Terminal Block 2 (In Backup Heater)

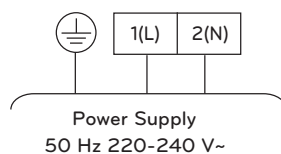

• For more information about installing Electric Heater, Please refer installation Manual provided with Electric Heater

※ The terminal block connection number may differ depending on the model. Refer to the "Wiring Diagram" in the SVC Manual.

**- For 4 Series**

Follow below procedures Step 1 ~ Step 4.

**Step 1.** Uncover the electric heater accessory.

**Step 2.** Find the terminal block and connect wires. (Wires are field-supplied item.)

**Step 3.** Connect terminal block ports of unit and electric heater accessory.

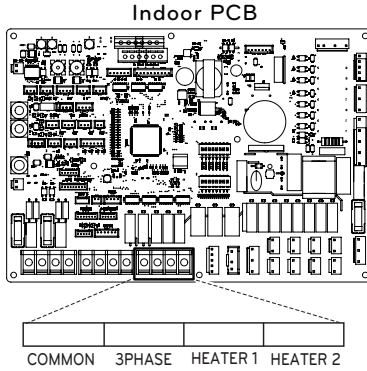
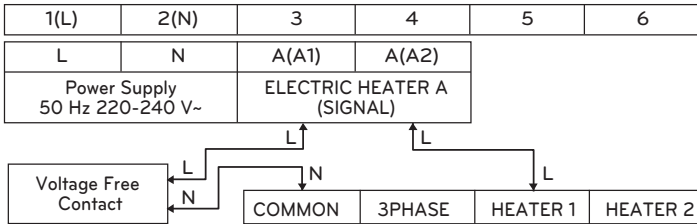
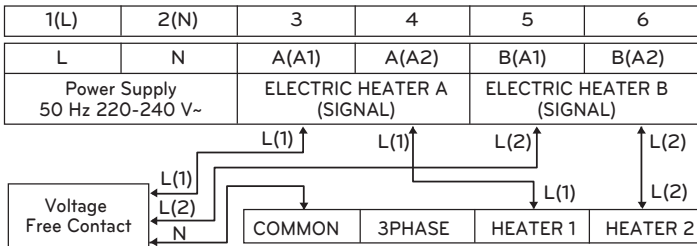
**(1Ø 3 kW) Terminal Block 2 (In Backup Heater)****(1Ø 6 kW) Terminal Block 2 (In Backup Heater)**

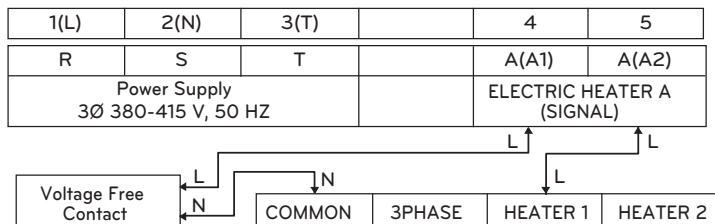
**(3Ø 6 kW) Terminal Block 2 (In Backup Heater)**

**Step 4.** Connect power supply cable to terminal block 2.

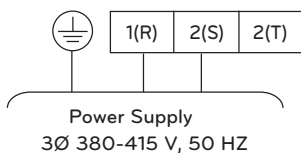
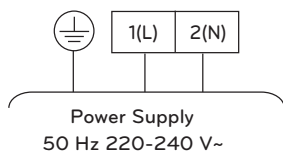

## How to Install 3way Valve for Backup Heater Bypass

Follow below procedures Step 1 ~ Step 2.

Step 1. Uncover front cover of the unit.

Step 2. Find terminal block and connect wire as below.

When Tightening the connect wire on terminal block, Be careful to prevent a shock or injury. (230 VAC)

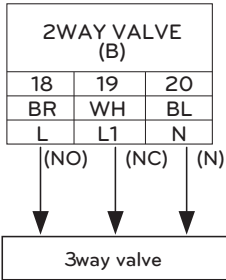

### WARNING

- When type of 2way valve is NO type, 3way valve should select Flow A(bypass). Electric power is supplied to wire(NO) and wire(N).
- When type of 2way valve is NC type, 3way valve should select Flow B(heating In Backup heater). Electric power is supplied to wire(NC) and wire(N).

### CAUTION

- 3way valve should be connected together with 2way valve in terminal block.
- Keep the distance between 3way valve and Backup Heater more than 0.5m.
- To prevent reverse flow, It is important to use one way valve(check valve) to Backup Heater water outlet.

## How to Connect Backup Heater Sensor to Unit

Follow below procedures Step 1 – Step 5.

- ① Find backup heater terminal block Kit(Fig. 1).
- ② Assemble the terminal block kit using screw on unit.
- ③ Plug it to 'E/Heater Out' (White Connector) of CN\_TH3 in the Main PCB (Unit) as shown Fig.2.
- ④ Connect harness between the unit and the Backup Heater until it clicks into place.(Fig. 3).
- ⑤ Use the cord clammer to fix the cable through low voltage hole.

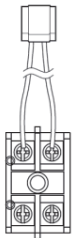

Fig.1

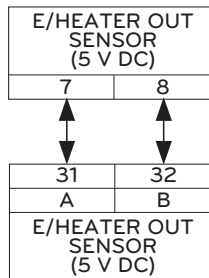

Fig.2



Fig.3

\* The terminal block connection number may differ depending on the model. Refer to the "Wiring Diagram" in the SVC Manual.

## Final check

| No. | Check point                               | Description   |
|-----|---|---|
| 1   | Connection of Water Inlet/Outlet          | <ul style="list-style-type: none"> <li>- Check if the shut-off valves should be assembled with Water inlet and outlet pipe of the unit</li> <li>- Check the location of the water inlet/outlet water pipe</li> </ul>  |
| 2   | Hydraulic pressure                        | <ul style="list-style-type: none"> <li>- Check the pressure of supplying water by using pressure gage inside the unit</li> <li>- Pressure of Supplying water should be Under 3.0 bar approximately</li> </ul>   |
| 3   | Water pump capacity                       | <ul style="list-style-type: none"> <li>- To secure enough water flow rate, do not set water pump capacity as Minimum.</li> <li>- It can lead unexpected flow rate error CH14. (Refer to Chapter 4 'Water Piping and Water Circuit Connection')</li> </ul>   |
| 4   | Transmission line and power source wiring | <ul style="list-style-type: none"> <li>- Check if Transmission line and power source wiring are separated from each other.</li> <li>- If it is not, electronic noise may occur from the power source.</li> </ul>  |
| 5   | The power cord specifications             | <ul style="list-style-type: none"> <li>- Check the power cord specifications (Refer to Chapter 4 'Connecting Cables')</li> </ul>  |
| 6   | 3Way Valve                                | <ul style="list-style-type: none"> <li>- Water should flow from Water outlet of the unit to DHW tank Water inlet when DHW tank heating is selected.</li> <li>- To verify the flow direction, Make sure that the water outlet temperature of the unit and water inlet temperature of DHW Water tank are similar</li> </ul>   |
| 7   | 2Way Valve                                | <ul style="list-style-type: none"> <li>- Water should not flow into under floor loop in cooling mode.</li> <li>- To verify the flow direction, check temperature at the water inlet of the under floor loop.</li> <li>- If correctly wired, this temperatures should not be approached to 6 °C in cooling mode.</li> </ul>  |
| 8   | Air Vent                                  | <ul style="list-style-type: none"> <li>- Air-vent must be located highest level of Water pipe system</li> <li>- It should be installed at the point which is easy to service.</li> <li>- It takes some times to remove air in the water system if air purge is not performed sufficiently it may occur CH14 error. (Refer to Chapter 4 'Water Charging')</li> </ul> |

# CONFIGURATION

As **THERMAV** is designed to satisfy various installation environment, it is important to set up system correctly. If not configured correctly, improper operation or degrade of performance can be expected.

- For 3 Series

## DIP Switch Setting

### ⚠ CAUTION

- Turn off electric power supply before setting DIP switch
- Whenever adjusting DIP switch, turn off electric power supply to avoid electric shock.





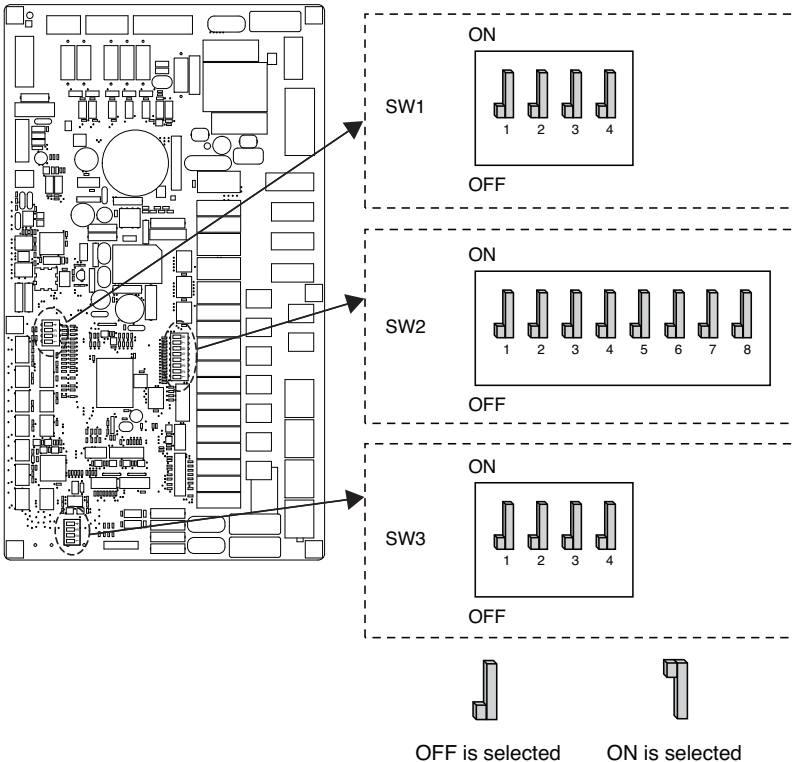



















### General Information

#### Indoor PCB









## DIP Switch Information







## Option Switch 2

| Description                              | Setting   |  | Default  |
|--|---|--|--|
| Role when central controller is equipped | 1    | As Master  | 1   |
|  | 1    | As Slave   |  |
| Accessory installation information       |  2  3     | Unit + Outdoor unit is installed                                   | 2 <br>3  |
|  |  2  3     | Unit + Outdoor unit + DHW tank is installed                        |  |
|  |  2  3     | Unit + Outdoor unit + DHW tank + Solar thermal system is installed |  |
| Cycle                                    | 4    | Heating Only   | 4   |
|  | 4    | Heating & Cooling  |  |
| Selecting electric heater capacity       |  6  7     | Electric heater is not used  | 6 <br>7  |
|  |  6  7     | Half capacity is used only for HA061M(AEH066A)                     |  |
|  |  6  7 | Full capacity is used  |  |
| Thermostat installation information      | 8    | Thermostat is NOT installed  | 8   |
|  | 8    | Thermostat is installed  |  |

## Option Switch 1

| Description     | Setting   |                              | Default   |
|-----------------|---|------------------------------|---|
| MODBUS          | 1  | As Master                    | 1  |
|                 | 1  | As Slave                     |   |
| MODBUS Function | 2  | Common 3 <sup>rd</sup> party | 2  |
|                 | 2  | SIEMENS                      |   |

## Option Switch 3

| Description       | Setting   |                                      | Default   |
|-------------------|---|--------------------------------------|---|
| Remote Air Sensor | 1  | Remote sensor is not installed       | 1  |
|                   | 1  | Remote sensor is installed           |   |
| ANTIFREEZE        | 2  | Antifreezing solution not using mode | 2  |
|                   | 2  | Antifreezing solution using mode     |   |

## Outdoor PCB General Information

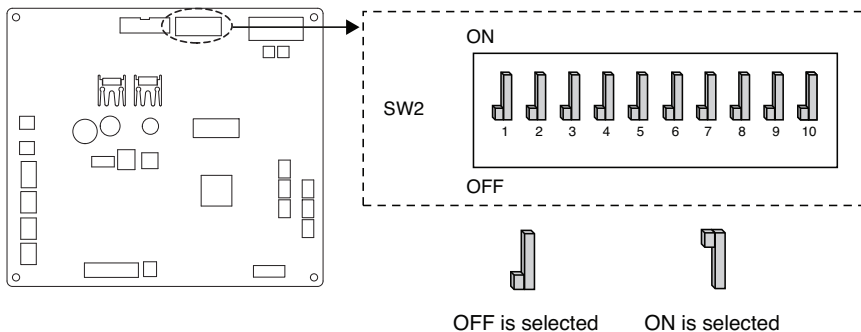

## DIP Switch Information

| Description    | Setting |  | Default |
|----------------|---------|--|---------|
| Low Noise Mode |         | Normal Low Noise Mode                                  |         |
|                |         | Limited Low Noise Mode                                 |         |
| Peak Control   |         | Max Mode   |         |
|                |         | Peak Control : To limit maximum current (Power saving) |         |

※ Only DIP Switch no. 2 and no.3 has a function. Others have no function.

※ When setting the limited low noise mode, Mode can be exited to secure capacity after operating for a certain time.

### NOTE

\* Input current value can be limited by DIP Switch operation.

| Model Name |           |               |         | Max. Mode Running Current (A) | Peak Control Mode Running Current (A) |
|------------|-----------|---------------|---------|-------------------------------|---------------------------------------|
| Chassis    | Phase (Ø) | Capacity (kW) | Mode    |                               |                                       |
| UN36A      | 1         | 5, 7, 9       | Cooling | 23                            | 17                                    |
|            |           |               | Heating | 23                            | 17                                    |
| UN60A      | 1         | 9             | Cooling | 15                            | 14                                    |
|            |           |               | Heating | 15                            | 14                                    |
|            |           | 12, 14, 16    | Cooling | 35                            | 25                                    |
|            |           |               | Heating | 35                            | 27                                    |
|            | 3         | 12, 14, 16    | Cooling | 15                            | 10                                    |
|            |           |               | Heating | 15                            | 12                                    |

- For 4 Series

## DIP Switch Setting

### CAUTION

Turn off electric power supply before setting DIP switch

- Whenever adjusting DIP switch, turn off electric power supply to avoid electric shock.





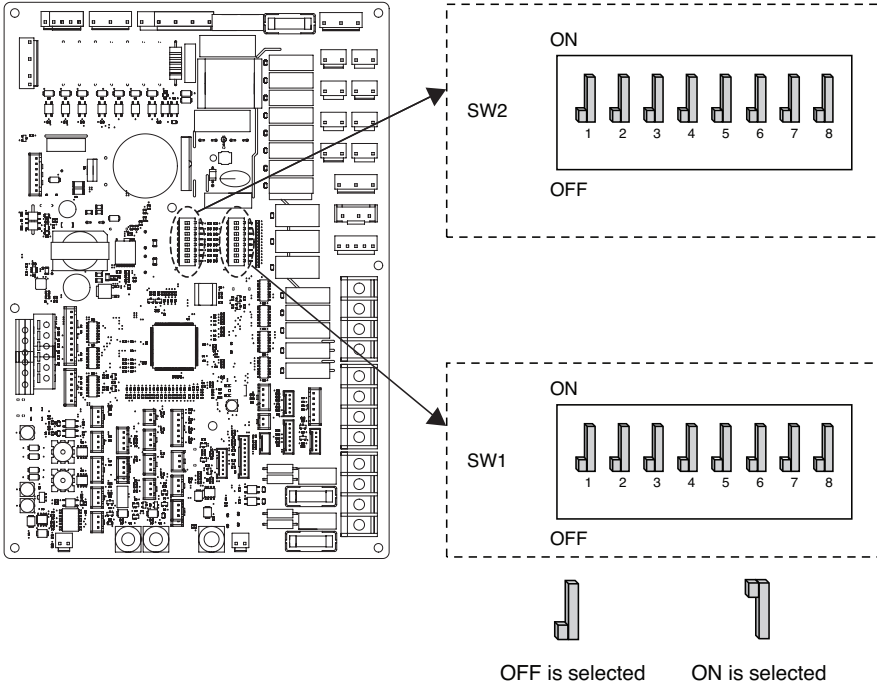























### General Information

#### Indoor PCB











## DIP Switch Information

## Option Switch 2

| Description                         | Setting  |  | Default  |
|-------------------------------------|--|--|--|
| Group Control                       | 1   | As Master  | 1   |
|                                     | 1   | As Slave   |  |
| Accessory installation information  |  <br>2 3     | Heat pump is installed (Heating(Cooling) circuit only)   | <br>   |
|                                     |  <br>2 3     | Heat pump + DHW tank is installed                        |  |
|                                     |  <br>2 3     | Heat pump + DHW tank + Solar thermal system is installed |  |
| Cycle                               | 4   | Heating Only   | 4   |
|                                     | 4   | Heating & Cooling  |  |
| Room Air Sensor                     | 5   | Room Air Sensor is not installed                         | 5   |
|                                     | 5   | Room Air Sensor is installed                             |  |
| Selecting electric heater capacity  |  <br>6 7     | Electric heater is not used                              | <br> |
|                                     |  <br>6 7     | Half capacity is used only for HA061M(AHEH066A)          |  |
|                                     |  <br>6 7 | Full capacity is used                                    |  |
| Thermostat installation information | 8   | Thermostat is NOT installed                              | 8   |
|                                     | 8   | Thermostat is installed                                  |  |

Option Switch 1



| Description               | Setting   |                                  | Default   |
|---------------------------|---|----------------------------------|---|
| MODBUS Communication Type | 1  | As Master (LG extension modules) | 1  |
|                           | 1  | As Slave (3rd party controller)  |   |
| MODBUS Function           | 2  | REGINE                           | 2  |
|                           | 2  | Unified Open Protocol            |   |
| Antifreeze Agent          | 8  | Antifreeze agent is not used     | 8  |
|                           | 8  | Antifreeze agent is used *       |   |

\* Possibility to allow colder water temperature by setting. Bridge at CN\_ANTI\_SW must be dis-connected to enable setting.

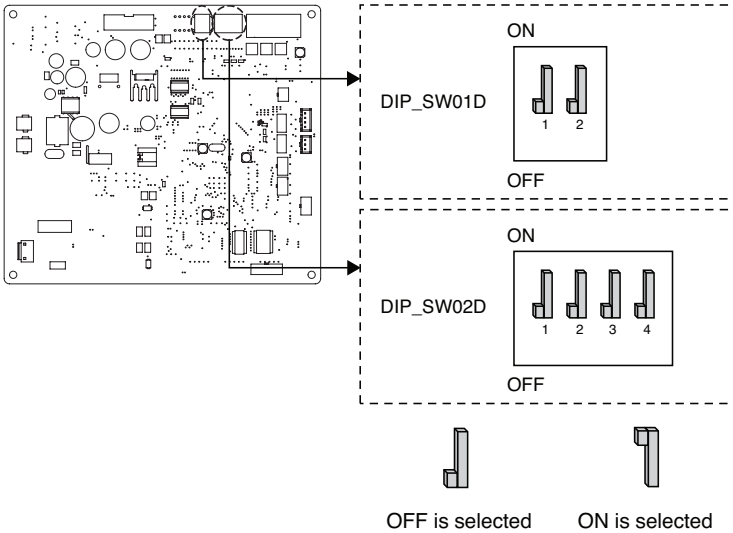







Outdoor PCB (12, 14, 16 kW)



## Option Switch 1

| Description    | Setting   |   | Default   |
|----------------|---|---|---|
| Low Noise Mode | 2  | Always Mode<br>- Maintain low noise mode for target temperature       | 2  |
|                | 2  | ON/OFF Partial mode<br>- Escape low noise mode for target temperature |   |

## Option Switch 2

| Description  | Setting   |  | Default  |
|--------------|---|--|--|
| Peak Control |  1  2 | Max Mode   | 1 <br>2  |
|              |  1  2 | Peak Control Step 1<br>- To limit maximum current (Power saving) |  |
|              |  1  2 | Peak Control Step 2<br>- To limit maximum current (Power saving) |  |

\* Only the switch in the table has a function. Others have no function.

\* When setting the on/off partial mode, Mode can be exited to secure capacity after operating for a certain time.

## NOTE

\* Input current value can be limited by DIP Switch operation.

| Capacity          | Mode    | Max Mode Running Current(A) | Peak Control Mode Running Current(A) |        |
|-------------------|---------|-----------------------------|--------------------------------------|--------|
|                   |         |                             | Step 1                               | Step 2 |
| 1Ø<br>12,14,16 kW | Cooling | 35                          | 25                                   | 22     |
|                   | Heating | 35                          | 25                                   | 22     |
| 3Ø<br>12,14,16 kW | Cooling | 15                          | 10                                   | 8      |
|                   | Heating | 15                          | 10                                   | 8      |

**NOTE****Emergency Operation****• Definition of terms**

- Trouble : a problem which can stop system operation, and can be resumed temporarily under limited operation without certificated professional's assist.
- Error : problem which can stop system operation, and can be resumed only after certificated professional's check.
- Emergency mode : temporary heating operation while system met Trouble.

**• Objective of introducing 'Trouble'**

- Not like airconditioning product, Air-to-Water heat pump is generally operation in whole winter season without any system stopping.
- If system found some problem, which is not critical to system operating for yielding heating energy, the system can temporarily continue in emergency mode operation with end user's decision.

**• Classified Trouble**

- Trouble is classified two levels according to the seriousness of the problem : Slight Trouble and Heavy trouble
- Slight Trouble : a problem is found inside the unit. In most case, this trouble is concerned with sensor problems. The outdoor unit is operating under emergency mode operation condition which is configured by DIP switch No. 4 of the unit PCB.
- Heavy trouble : a problem is found inside the outdoor unit. As the outdoor unit has problem, the emergency mode operation is performed by electric heater located in the unit.
- Option Trouble : a problem is found for option operation such as water tank heating. In this trouble, the troubled option is assumed as if it is not installed at the system.

**• When the AWHP has any trouble,**

(1) If there is not a function to judge possibility of operation :

Once an error occurs mainly in indoor unit, AWHP stops. On the other hand, Remocon allows the product to activate On/ Off operation.(On : emergency operation)

- Slight / Heavy trouble : Heating Operable only
- Critical trouble : Full stop
- Treatment priority : Critical>Heavy>Slight

(2) If there is a function to judge possibility of operation :

Depending on the status of slight / heavy / critical trouble, pop-up phrase is guided separately on display.

- Slight trouble : Heating/Cooling Operable
- Heavy trouble : Heating Operable only
- Critical trouble : Service center request

AWHP operates when user pressed OK button on pop-up window.

**NOTE****• Duplicated trouble : Option trouble with slight or heavy trouble**

- If option trouble is occurred with slight (or heavy) trouble at the same time, the system puts higher priority to slight (or heavy) trouble and operates as if slight (or heavy) trouble is occurred.
- Therefore, sometimes DHW heating can be impossible in emergency operation mode. When DHW is not warming up while emergency operation, please check if DHW sensor and related wiring are all OK.

**• Emergency operation is not automatically restarted after main electricity power is reset.**

- In normal condition, the product operating information is restored and automatically restarted after main electricity power is reset.
- But in emergency operation, automatic re-start is prohibited to protect the product.
- Therefore, user must restart the product after power reset when emergency operation has been running.

# SERVICE SETTING

## How to enter service setting

To enter the menu displayed at the bottom, you need to enter the service setting menu as follows.

- In the menu screen, press [←,→(left/right)] button to select the setting category, and press [OK] button to move to the setting list.
- In the setting list, select the service setting category, and press [OK] button to move to the service setting list.

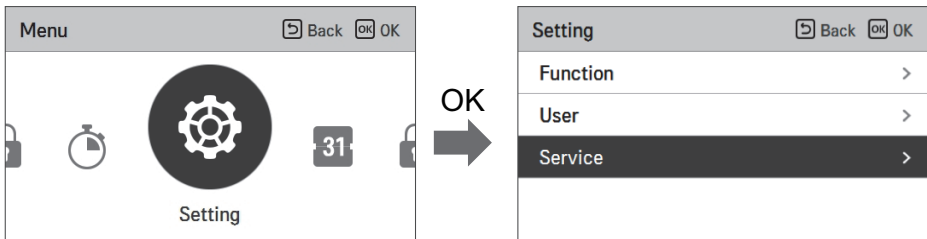

## Service setting

- You can set the product service functions.
- Some functions may not be displayed/operated in some product types.

| Menu                    | Description  |
|-------------------------|--|
| Service contact         | Check and input the service center phone number that you can call when there is service issue. |
| Model information       | View product and capacity information  |
| RMC Version Information | Check the remote controller model name and software version.                                   |
| Open Source License     | View the remote controller's open source license.  |

## Service Contact

Check and input the service center phone number that you can call when there is service issue.

- In the service setting list, select the service contact point and press [OK] button to move to the detail screen.
- While “edit” button is selected, press [OK] button to move to the edit screen, change it, and press [OK] button to change the service contact point.

| Service                 | Back | OK |
|-------------------------|------|----|
| Service Contact         | >    |    |
| Model Information       | >    |    |
| RMC Version Information | >    |    |
| Open Source License     | >    |    |



OK

| Service Contact                | Back | OK |
|--------------------------------|------|----|
| Telephone<br><b>+1544-7777</b> |      |    |
| <b>Edit</b>                    |      |    |



OK

| Service Contact | Back | OK |
|-----------------|------|----|
| Telephone       |      |    |
| + 1 5 4 4 - 7 7 |      |    |
| 7 7             |      |    |

## Model Information

Check product and capacity information to which the remote controller is connected.

- In the service setting list, select model information category, and press [OK] button to move to the detail screen.
- The unit capacity
  - $1 \text{ kWh} = 1 \text{ kBtu} * 0.29307$
  - kWh is the result calculated based on Btu, There may be a small difference between calculated and actual capacity.
  - Ex) If the unit capacity is 18 kBtu, it is displayed as 5 kWh.

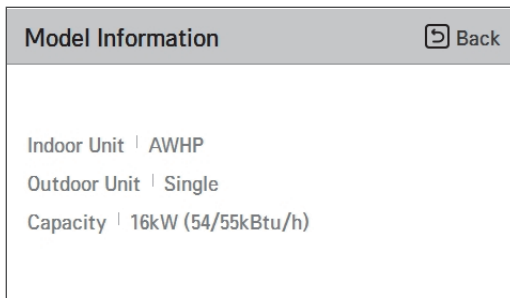
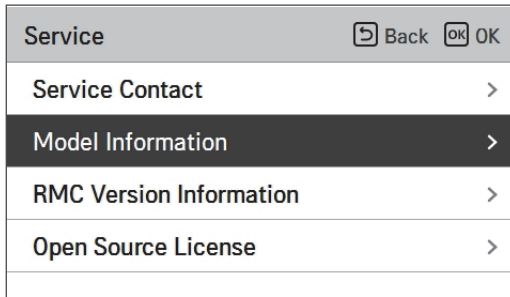

## RMC Version Information

View the remote controller software version.

- In the service setting list, select the RMC version information and press [OK] button to move to the detail screen

| Service                        | Back | OK |
|--------------------------------|------|----|
| Service Contact                | >    |    |
| Model Information              | >    |    |
| <b>RMC Version Information</b> | >    |    |
| Open Source License            | >    |    |



| RMC Version Information | Back |
|-------------------------|------|
| SW Version   3.03.1a    |      |

## Open Source License

View the remote controller's open source license.

- In the service setting list, select the open source license category, and press [OK] button to move to the detail screen.

| Service                    | ⏪ Back | OK |
|----------------------------|--------|----|
| Service Contact            |        | >  |
| Model Information          |        | >  |
| RMC Version Information    |        | >  |
| <b>Open Source License</b> |        | >  |



| Open Source License  |                             | ⏪ Back |
|--|-----------------------------|--------|
| <b>LGE Open Source Software Notice</b>   |                             |        |
| Product Type   | HVAC WIRED REMOTE CONTR     |        |
| Model Number/Range   | RS3 Wired Remote Controller | 1/401  |
| Those products identified by the Product Type and Model Range above from LG Electronics, Inc. ("LGE") contain the open source software detailed below. Please refer to the |                             |        |

# INSTALLER SETTING

## How to enter installer setting

### CAUTION

The installer setting mode is the mode to set the remote controller's detail function. If the installer setting mode is incorrectly set, it may cause product failure, user's injury, or property damage. It must be set by the installation specialist with the installation license, and if it is installed or changed without installation license, all problems caused will be the responsibility of the installer, and may void the LG warranty.

- In the menu screen, press [,<,>(left/right)] button to select the setting category, and press [^ (up)] button for 3 seconds to enter the password input screen for the installer setting.
- Input the password and press [OK] button to move to the installer setting list.

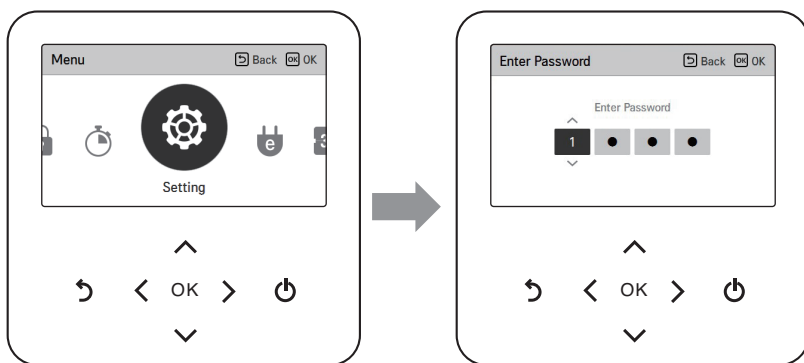

※ Installer setting password

Main screen → menu → setting → service → RMC version information → SW Version

Example) SW version : 1.00.1 a

In the above case, the password is 1001.

### NOTE

Some categories of the installer setting menu may not be available depending on the product function or the menu name may be different.

## Installer setting (For 3 Series)

- You can set the product user functions.
- Some functions may not be displayed/operated in some product types.

| Function                              | Description   |
|---------------------------------------|---|
| 3 Minutes Delay                       | Factory use only  |
| Select Temperature Sensor             | Selection for setting temperature as air temperature or leaving water temperature or air+leaving water temperature  |
| Dry Contact Mode                      | Dry contact function is the function that can be used only when the dry contact devices is separately purchased and installed.  |
| Central Control address               | When connecting the central control, set the central control address of the unit.   |
| Pump Test run                         | Water pump test run   |
| Air cooling set temp.                 | Adjusting range of 'Setting Air Temperature' in cooling mode  |
| Water cooling set temp.               | Adjusting range of 'Setting Leaving Water Temperature' in cooling mode  |
| Air heating set temp.                 | Adjusting range of 'Setting Air Temperature' in heating mode  |
| Water heating set temp.               | Adjusting range of 'Setting Heating Flow Temperature' in heating mode   |
| DHW Set Temp.                         | Setting DHW set temperature   |
| Screed drying                         | Setting for using Step 1 or 2 capacity of electric  |
| Heater on temperature                 | Setting outdoor air temperature where half capacity of electric heater starts operation.  |
| Water supply off temp. during cooling | Determine leaving water temperature when the unit is turned off. This function is used for preventing condensation on the floor in cooling mode                               |
| Tank disinfection setting 1, 2        | Setting start/maintain time for pasteurisation<br>Setting pasteurisation temperature  |
| Tank setting 1                        | Setting start temperature for operation   |
| Tank setting 2                        | Setting maintain temperature for operation  |
| Heater priority                       | Determine electric heater and water heater on and off   |
| DHW time setting                      | Determine follow time duration : operation time of domestic hot water tank heating, stop time of domestic hot water tank heating, and delay time of DHW tank heater operating |
| TH on/off Variable, heating air       | Heating air temperature TH On / Off Type setting  |
| TH on/off Variable, heating Water     | Heating Water Outlet Temperature TH On / Off Type   |

| Function                          | Description   |
|-----------------------------------|---|
| TH on/off Variable, cooling air   | Cooling air temperature TH On / Off Type setting  |
| TH on/off Variable, cooling Water | Cooling Water Outlet Temperature TH On / Off Type   |
| Heating temp. setting             | At the leaving water control in heating mode, the control reference water temperature position setting  |
| Cooling temp. setting             | At the leaving water control in cooling mode, the control reference water temperature position setting  |
| Pump setting in heating           | Set water pump on / off delay option in heating mode  |
| Pump setting in cooling           | Set water pump on / off delay option in cooling mode  |
| Forced operation                  | Water pump off After 20 consecutive hours, disable / enable the logic that drives the water pump by itself  |
| CN_CC                             | It is the function to set whether to install (use) Dry Contact. (It is not a function for Dry Contact installation, but it is a function to set the usage of the unit's CN_CC port.)                        |
| Pump Capacity                     | Function to change Water Pump Capacity  |
| Seasonal auto temp                | Set the operating temperature in Seasonal Auto mode   |
| Modbus Address                    | It is function to set the address of the Modbus device that is externally linked to the product. Modbus address setting function is available from indoor unit.   |
| CN_EXT                            | Function to set external input and output control according to DI / DO set by customer using dry contact port of indoor unit. Determine the use of the contact port (CN_EXT) mounted on the indoor unit PCB |
| Anti-freezing Temperature         | This function prevents the product from freezing.   |
| Add Zone                          | Install additional valve in product to control additional operation area  |
| Use External Pump                 | Set up to control an external water pump  |
| 3rd Party Boiler                  | Configuration to control 3rd party boiler   |
| Meter Interface                   | When installing the meter interface to measure energy / calorie in the product, set unit spec for each port   |
| Pump Prerun/Overrun               | Set to reach the optimum flow rate by circulating the heating water with the water pump before heat exchange. After the operation stop, additional water pump is activated to circulate the heating water.  |
| Solar Thermal System              | Function to set operation reference value in Solar Thermal System.  |
| Energy state                      | This function is to control the product according to the energy state. ESS USE TYPE can be selected and product operation can be changed according to energy state.   |
| Data logging                      | Display error history of connected unit   |
| Password Initialization           | It is the function to initialize (0000) the password when you forgot the password set in the remote controller.   |

## 3 Minutes Delay

Temporarily eliminates the 3-minute delay function of the outdoor unit Comp

- Factory use only

- In the installer setting list, select 3 Minutes Delay category, and press [OK] button to move to the detail screen.

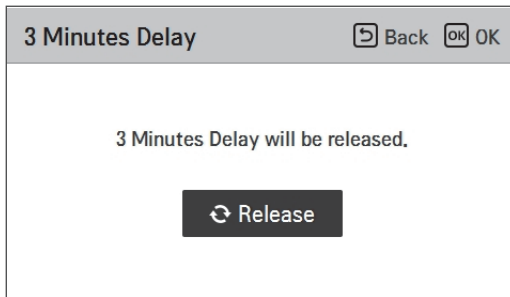
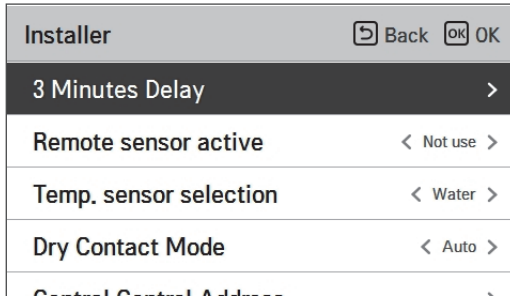

## Select Temperature Sensor

The product can be operated according to air temperature or leaving water temperature. The selection for setting temperature as air temperature or leaving water temperature is determined.

- In the installer setting list, Select Temperature Sensor category, and press [OK] button to move to the detail screen.

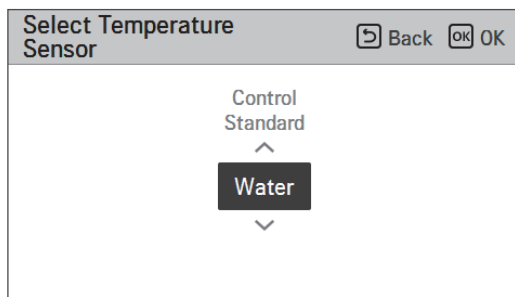
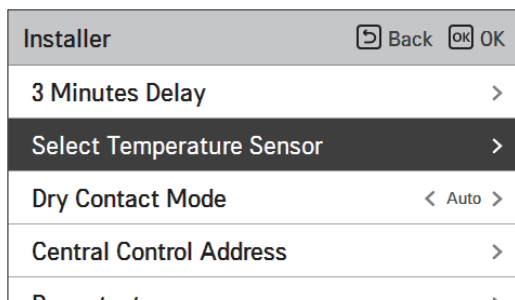

| Value |     |           |
|-------|-----|-----------|
| Water | Air | Air+Water |



### NOTE

Air temperature as setting temperature is ONLY available when Remote Air Sensor Connection is enabled and Remote Air Sensor Connection is set as 02.

## Dry Contact Mode

Dry contact function is the function that can be used only when the dry contact devices is separately purchased and installed.

- Change setting values using [**<**,**>**(left/right)] button.

|                         |   |
|-------------------------|---|
| Installer               |  Back  OK |
| 3 Minutes Delay         | >   |
| Remote sensor active    | < Not use >   |
| Temp. sensor selection  | < Water >   |
| Dry Contact Mode        | < Auto >  |
| Control Control Address | >   |

| Value  |
|--------|
| Auto   |
| manual |

### NOTE

For dry contact mode related detail functions, refer to the individual dry contact manual.

What is dry contact?

It means the contact point signal input when the hotel card key, human body detection sensor, etc. are interfacing with the air conditioner.

Added system functionality by using external inputs (dry contacts and wet contacts).

## Central Control Address

When connecting the central control, set the central control address of the unit.

- In the installer setting list, select Central Control Address category, and press [OK] button to move to the detail screen.

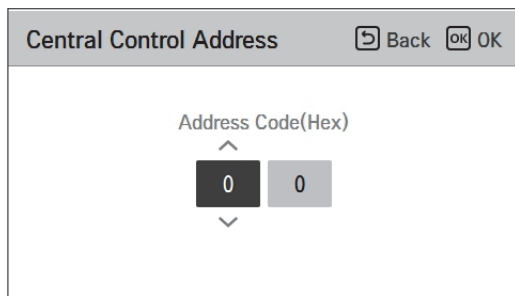
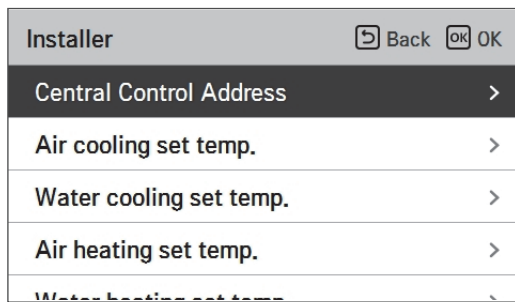

### NOTE

Enter address code as hexadecimal value  
 Front: Central Control Gr. No.  
 Back side: Central control indoor the number

### NOTE

This function is not available for monobloc

## Pump test run

The pump test run is the function to test run by operating the water pump. This function can be used for air vents / flow sensors and others.

- In the installer setting list, Pump Test run category, and press [OK] button to move to the detail screen.

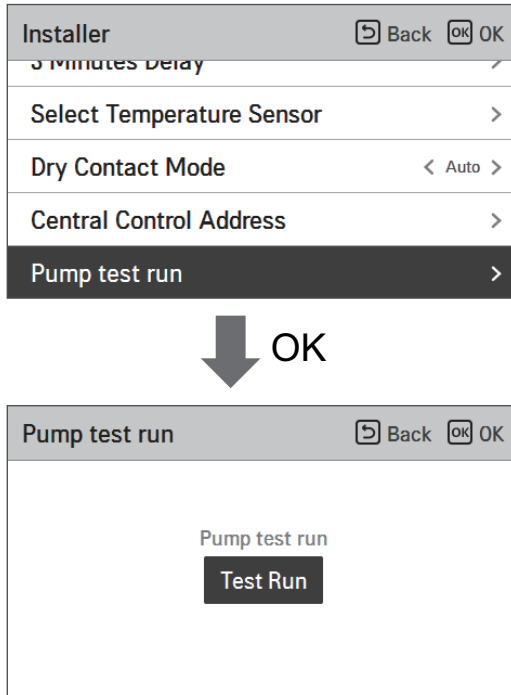

## Air cooling set temp

Determine cooling setting temperature range when air temperature is selected as setting temperature.

- In the installer setting list, select Air cooling set temp category, and press [OK] button to move to the detail screen.

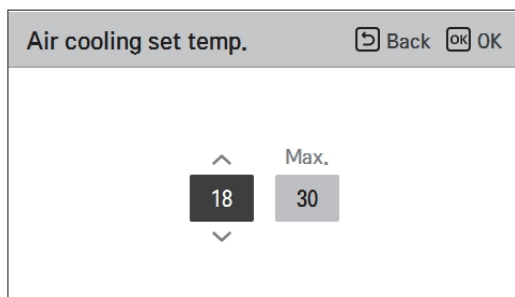
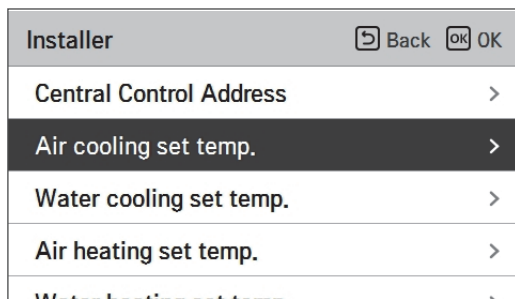

| Value | Default | Range |
|-------|---------|-------|
| Max.  | 30      | 30~24 |
| Min.  | 18      | 22~16 |

\* Upper / lower limit / default value is in °C

### NOTE

Only available when remote air temperature sensor is connected.

- Accessory PQRSTA0 should be installed.
- Also, Remote air sensor connection should be set properly.

## Water cooling set temp

Determine cooling setting temperature range when leaving water temperature is selected as setting temperature.

- In the installer setting list, select water cooling set temp category, and press [OK] button to move to the detail screen.

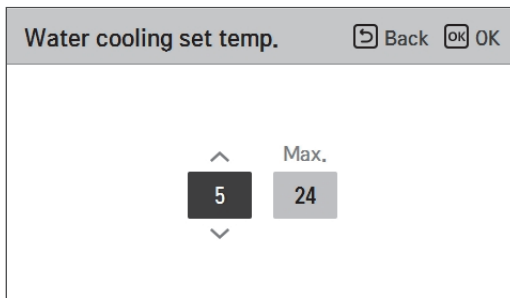
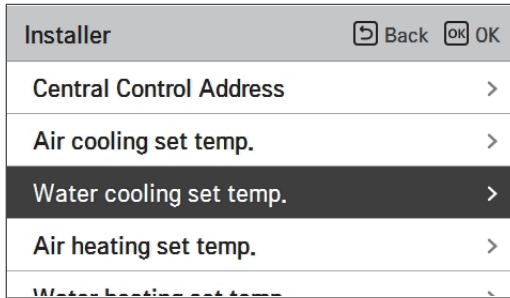

| Value | Default | Range |
|-------|---------|-------|
| Max.  | 24      | 27~22 |
| Min.  | 18      | 20~5  |

\* Upper / lower limit / default value is in °C

### NOTE

Water condensation on the floor

- While cooling operation, it is very important to keep leaving water temperature higher than 16 °C. Otherwise, dew condensation can be occurred on the floor.
- If floor is in humid environment, do not set leaving water temperature below 18 °C.

### NOTE

Water condensation on the radiator

- While cooling operation, cold water may not flow to the radiator. If cold water enters to the radiator, dew generation on the surface of the radiator can be occurred.

## Air heating set temp

Determine heating setting temperature range when air temperature is selected as setting temperature

- In the installer setting list, select Air heating set temp. category, and press [OK] button to move to the detail screen.

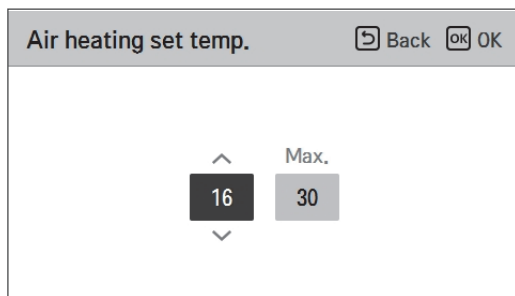
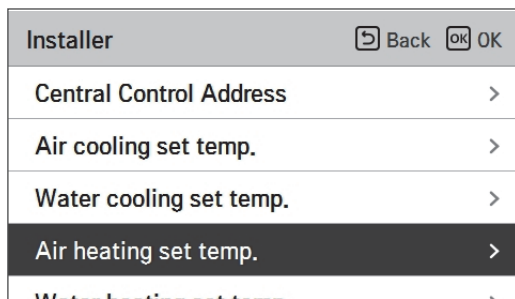

| Value | Default | Range |
|-------|---------|-------|
| Max.  | 30      | 30~24 |
| Min.  | 16      | 22~16 |

\* Upper / lower limit / default value is in °C

### CAUTION

Only available when remote air temperature sensor is connected.

- Accessory PQRSTA0 should be installed.
- Also, Remote air sensor connection should be set properly.

## Water heating set temp

Determine heating setting temperature range when leaving water temperature is selected as setting temperature

- In the installer setting list, select Water heating set temp. category, and press [OK] button to move to the detail screen.

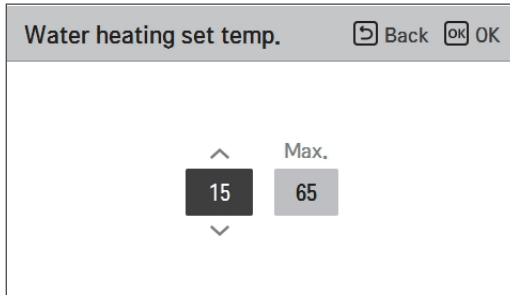
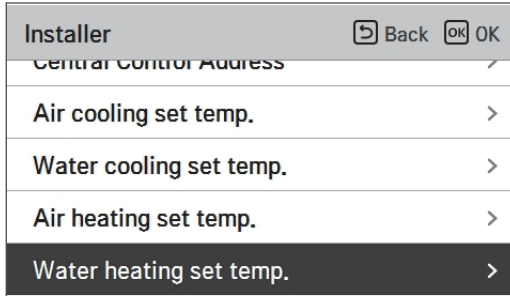

| Value | Default | Range |
|-------|---------|-------|
| Max.  | 65      | 65~35 |
| Min.  | 15      | 34~15 |

\* Upper / lower limit / default value is in °C

### NOTE

- When the E/heater is not used, the minimum temperature of the water temperature can be set from 34 °C to 20 °C

## DHW set temp

Determine heating setting temperature range when DHW temperature is selected as setting temperature

- In the installer setting list, select DHW set temp. category, and press [OK] button to move to the detail screen.

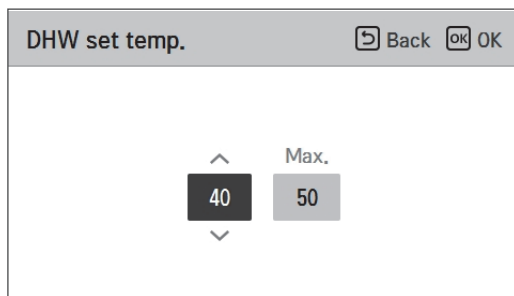
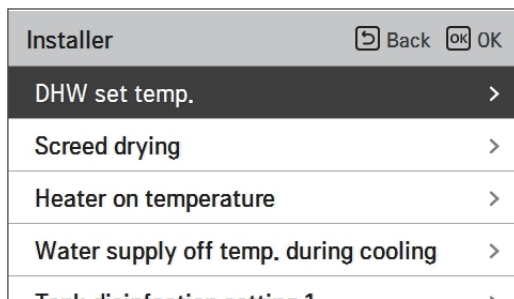

| Value | Range |
|-------|-------|
| Max.  | 80~50 |
| Min.  | 40~30 |

\* Upper / lower limit / default value is in °C

## Screed drying

This function is a unique feature of AWHP that, when AWHP is installed in a new concrete structure, controls the specific temperature floor heating out temperature for a certain period of time to cure the floor cement.

- In the installer setting list, select Screed drying category, and press [OK] button to move to the detail screen.

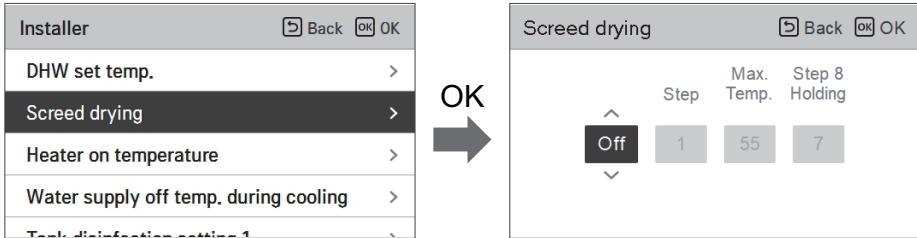

### How to display

Main Screen - Displays 'Screed drying' on the desired temperature display. The step in progress at the bottom of the display is displayed.

### Setting value

- Start-up step: 1 ~ 11
- Maximum temperature : 35 °C ~ 55 °C
- Step 8 Holding time : 1 days ~ 30 days

### Function operation

- It is performed by the following procedure from the selected starting step.
- After all steps are completed, turn off the cement curing operation.

| Step                                  | 1  | 2     | 3   | 4  | 5  | 6  | 7     | 8            | 9  | 10 | 11 |
|---------------------------------------|----|-------|-----|----|----|----|-------|--------------|----|----|----|
| Leaving Water target temperature[ °C] | 25 | Max.T | Off | 25 | 35 | 45 | Max.T | Max.T        | 45 | 35 | 25 |
| Duration [hours]                      | 72 | 96    | 72  | 24 | 24 | 24 | 24    | Holding time | 72 | 72 | 72 |

- ※ If the upper limit setting value of the heating LW temperature is 55 °C or lower, it is set to 55 °C forcibly.
- If the lower limit setting value of the heating LW temperature is 25 °C or higher, it is set to 25 °C forcibly.

## NOTE

- During Screed drying operation, button input except for installer function and temperature display is restricted.
- When the power is applied again after a power outage during product operation, the product operation state before power failure is remembered and the product is automatically operated.
- Screed drying operation stops when an error occurs / When error is cleared, restart cement Screed drying. (However, if the wired remote control is reset to the error occurrence state, it is compensated in the unit of one day)
- Upon releasing after an error, Screed drying operation may take up to 1 minute of waiting time after boot up. (The Screed drying operation status is judged as 1 minute cycle.)
- During Screed drying operation, installer function Screed drying operation is selectable.
- During Screed drying operation, starting operation, low noise mode off, low noise time setting off, hot water off, solar heat off.
- During Screed drying operation, simple, sleep, on, off, weekly, holiday, heater does not execute reservation operation.

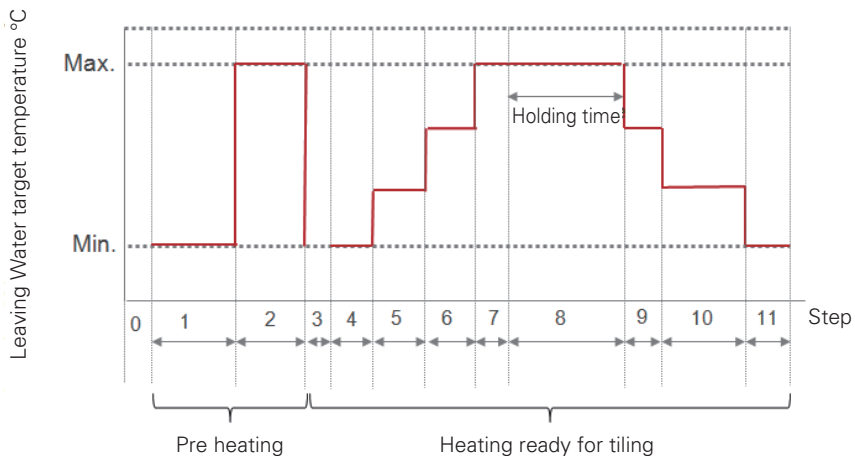

## Heater on temperature

Depending on local climatic conditions, it is necessary to change the temperature condition in which electric heater turns on / off.

- In the installer setting list, Heater on temperature category, and press [OK] button to move to the detail screen.

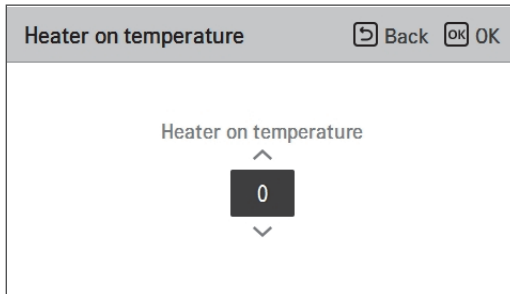
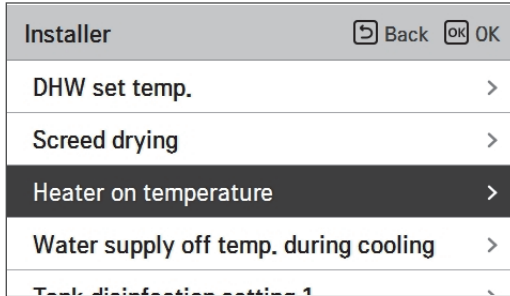

|       | Default | Range  |
|-------|---------|--------|
| Split | -5      | 18~-15 |
| Mono  | -5      | 18~-25 |

\* Upper / lower limit / default value is in °C

**NOTE****• Heater on temperature**

Using Half capacity of electric heater : when DIP Switch No. 6 and 7 is set as 'OFF-ON' :

- Example : If Heater on temperature is set as '-1' and DIP switch No 6. and 7 is set as 'OFF-ON', then half capacity of electric heater will start operation when outdoor air temperature is below -1 °C and current leaving water temperature or room air temperature is much below than target leaving water temperature or target room air temperature.

Using Full capacity of electric heater : when DIP Switch No. 6 and 7 is set as 'OFF-OFF' :

- Example : If Heater on temperature is set as '-1' and DIP switch No 6. and 7 is set as 'OFF-OFF', then full capacity of electric heater will start operation when outdoor air temperature is below -1 °C and current leaving water temperature or room air temperature is much below than target leaving water temperature or target room air temperature.

## Water supply off temp. during cooling

Determine leaving water temperature when the unit is turned off. This function is used for preventing condensation on the floor in cooling mode

- In the installer setting list, select Water supply off temp. during cooling category, and press [OK] button to move to the detail screen.

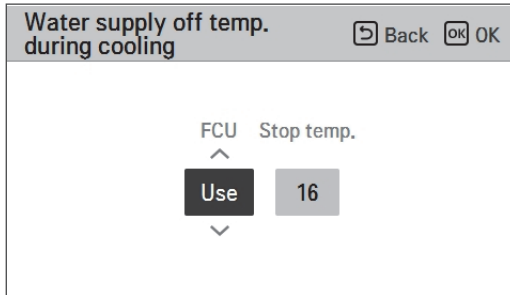
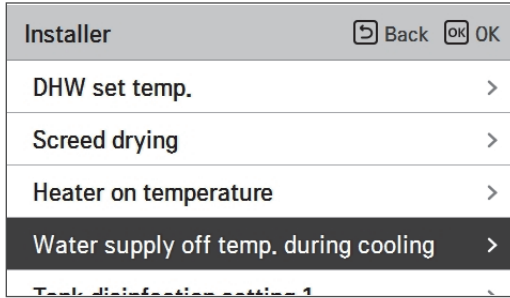

| Function                  | Value                        | Default | Setting Rang  |
|---------------------------|------------------------------|---------|---------------|
| cooling water temperature | Water supply off temperature | 16      | 25~16         |
|                           | FCU Use/ not use             | use     | Use / Not Use |

- Stop temp. : cut-off temperature. Stop temp. is valid when FCU is installed.
- FCU : determines if FCU is installed or not.
- Example : If Stop temp. is set as '10' and FCU is 'Use' and actually FCU is NOT installed in the water loop, the unit stop operation in cooling mode when the leaving water temperature is below 10 °C.
- Example : If Stop temp. is set as '10' and FCU is 'Not use' and actually FCU is installed in the water loop, the Stop temp. is not used and the unit do NOT stop operation in cooling mode when the leaving water temperature is below 10 °C.



## CAUTION

### FCU Installation

- If FCU is used, related 2way valve should be installed and connected to the unit PCB.
- If FCU is set as 'Not use' but FCU or 2way valve is NOT installed, the unit can do abnormal operation.

## Tank disinfection setting 1, 2

- Disinfection operation is special DHW tank operation mode to kill and to prevent growth of legionella inside the tank.
  - Disinfection active : Selecting enable or disable of disinfection operation.
  - Start date : Determining the date when the disinfection mode is running.
  - Start time : Determining the time when the disinfection mode is running.
  - Max temp. : Target temperature of disinfection mode.
  - Duration time : Duration of disinfection mode.

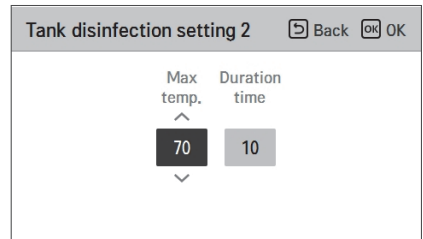
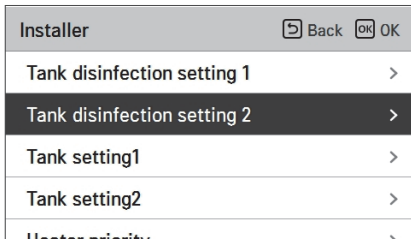
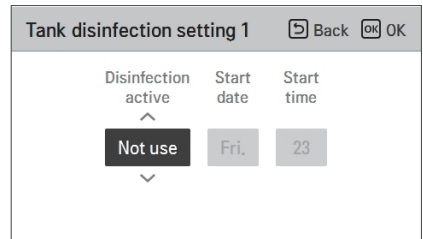
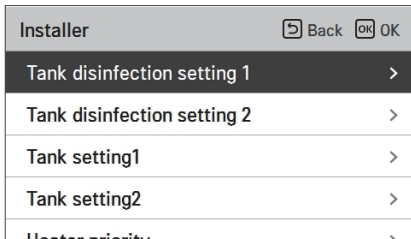
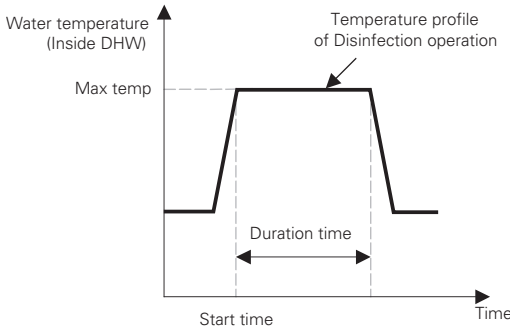

### NOTE

DHW heating should be enable

- If Disinfection active is set as 'Not use', that is 'disable disinfection mode', Start date and Start time is not used.

## Tank setting 1

- In the installer setting list, select tank setting 1 category, and press [OK] button to move to the detail screen.

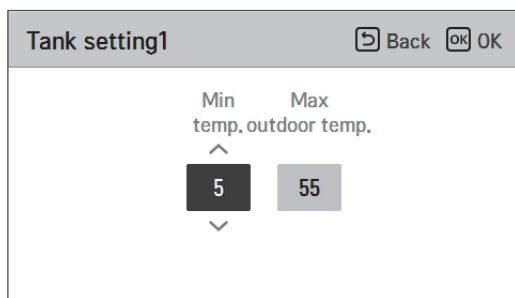
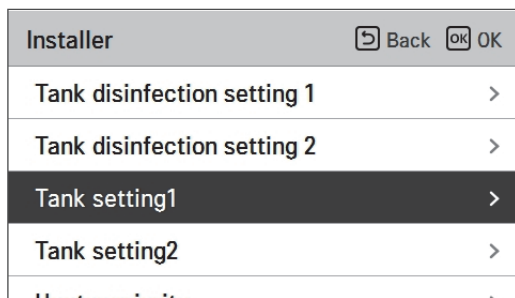

| Value            | Range |
|------------------|-------|
| Max outdoor temp | 58~40 |
| Min temp         | 30~1  |

## Tank setting 2

- In the installer setting list, select tank setting 2 category, and press [OK] button to move to the detail screen.

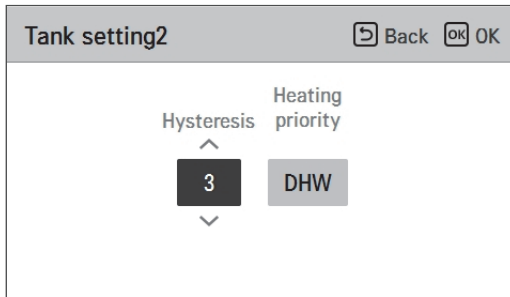
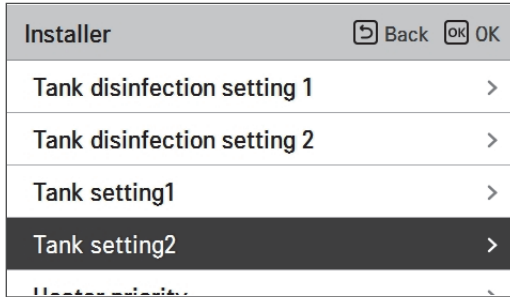

| Value            | Range               |
|------------------|---------------------|
| Hysteresis       | 4~2                 |
| Heating priority | Floor heating / DHW |

### • Tank setting 1, 2

Descriptions for each parameters are as following.

- Min temp. : temperature gap from Max outdoor temp.
- Max outdoor temp. : maximum temperature generated by AWHP compressor cycle.
- Example : If Min temp. is set as '5' and Max outdoor temp. is set as '48', then Session A (see the graph) will be started when the water tank temperature is below 45 °C.... If temperature is above 48 °C..., then Session B will be started.
- Hysteresis : temperature gap from target DHW temperature. This value is required to frequent On and Off of water tank heater.
- Heating priority : Determining heating demand priority between DHW tank heating and under floor heating.
- Example : If user's target temperature is set as '70' and Hysteresis is set as '3', then the water tank heater will be turned off when the water temperature is above 73 °C. The water tank heater will be turned on when the water temperature is below 70 °C.
- Example : If Heating priority is set as 'DHW', that means heating priority is on DHW heating, DHW is heated by AWHP compressor cycle and water heater. In this case the under floor can not be heated while DHW heating. On the other hand, if the Heating priority is set as 'Floor heating', that means heating priority is on under floor heating, DHW tank is ONLY heated by water heater. In this case the under floor heating is not stopped while DHW is heated.

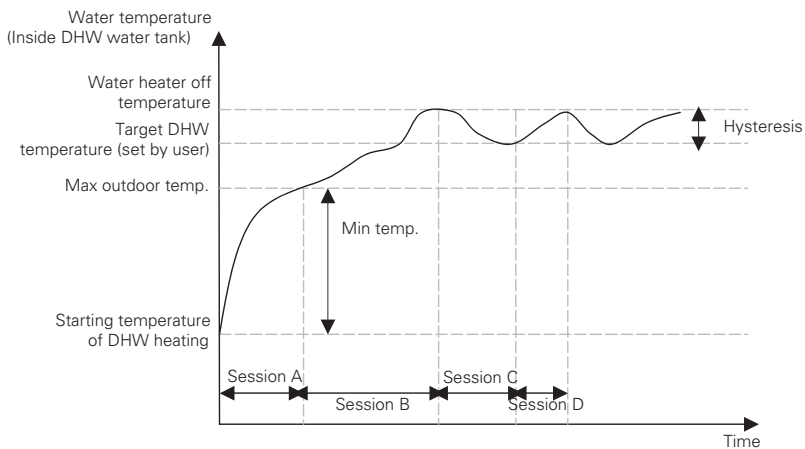

Session A : Heating by AWHP compressor cycle and water heater

Session B : Heating by water heater

Session C : No heating (Water heater is Off)

Session D : Heating by water heater

### NOTE

DHW heating does not operate when it is disabled.

## Heater priority

- Heater priority : determine electric heater and DHW tank heater on and off.
- Example : If Heater priority is set as 'Main+Boost heater ON', then electric heater and DHW tank heater are on and off according to control logic. If Heater priority is set as 'Boost heater only ON', then electric heater is never turned on and only DHW tank heater is on and off according to control logic.
- In the installer setting list, heater priority category, and press [OK] button to move to the detail screen.

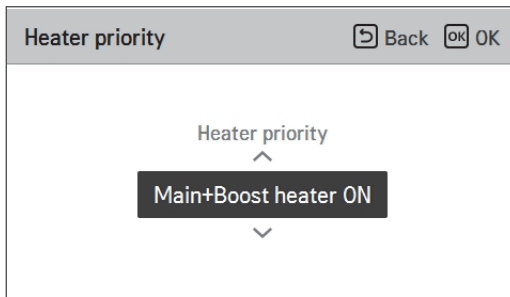
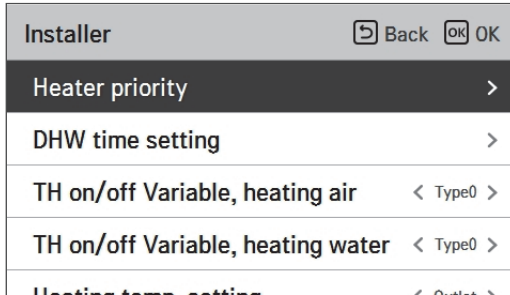

| Value                |                      |
|----------------------|----------------------|
| Boost heater only ON | Main+Boost heater ON |

## DHW time setting

Determine following time duration : operation time of DHW tank heating, stop time of DHW tank heating, and delay time of DHW tank heater operating.

- Active time : This time duration defines how long time DHW tank heating can be continued.
- Stop time : This time duration defines how long time DHW tank heating can be stopped. It is also regarded as time gap between DHW tank heating cycle.
- Boost heater delay time : This time duration defines how long time DHW tank heater will not be turned on in DHW heating operation.
- Example of timing chart :

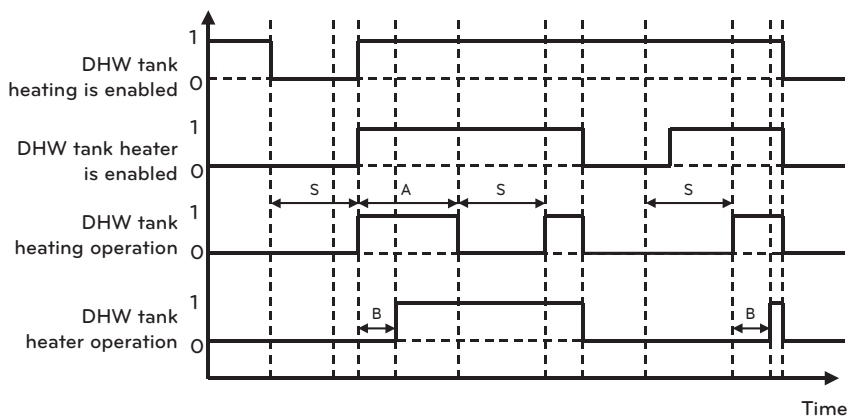

- \* 1=active / 0=not active
- \* A = Active time
- \* S = Stop time
- \* B = Boost heater delay time

| Installer                         |           | Back | OK |
|-----------------------------------|-----------|------|----|
| Heater priority                   | >         |      |    |
| <b>DHW time setting</b>           | >         |      |    |
| TH on/off Variable, heating air   | < Type0 > |      |    |
| TH on/off Variable, heating water | < Type0 > |      |    |
| Heating temp. setting             | < Out >   |      |    |

OK



| DHW time setting |           |                         |  | Back | OK |
|------------------|-----------|-------------------------|--|------|----|
| Active time      | Stop time | Boost heater delay time |  |      |    |
| 30               | 180       | 20                      |  |      |    |

## TH on/off Variable, heating air

It is a function to adjust the heating air temperature Thermal On / Off temperature according to the field environment in preparation for heating or heating claim.

- You can set the following setting values using [<,>(left/right)] button.

|                                   |         |      |
|-----------------------------------|---------|------|
| Installer                         | ⏪ Back  | OK ⏩ |
| Heater priority                   |         | >    |
| DHW time setting                  |         | >    |
| TH on/off Variable, heating air   | < Type0 | >    |
| TH on/off Variable, heating water | < Type0 | >    |
| Heating temp. setting             | < Type0 | >    |

| Value | Description |        |
|-------|-------------|--------|
|       | TH On       | TH Off |
| Type0 | -0.5 °C     | 1.5 °C |
| Type1 | -1 °C       | 2 °C   |
| Type2 | -2 °C       | 3 °C   |
| Type3 | -3 °C       | 4 °C   |

## TH on/off Variable, heating water

It is a function to adjust the heating water temperature Thermal On / Off temperature according to the field environment in preparation for heating or heating claim.

- You can set the following setting values using [**<**,**>**(left/right)] button.

|  |         |    |
|--|---------|----|
| Installer                                | Back    | OK |
| Heater priority                          |         | >  |
| DHW time setting                         |         | >  |
| TH on/off Variable, heating air          | < Type0 | >  |
| <b>TH on/off Variable, heating water</b> | < Type0 | >  |
| Heating temp. setting                    |         | >  |

| Value | Description |        |
|-------|-------------|--------|
|       | TH On       | TH Off |
| Type0 | -2 °C       | 2 °C   |
| Type1 | -3 °C       | 3 °C   |
| Type2 | -4 °C       | 4 °C   |
| Type3 | -1 °C       | 1 °C   |



## TH on/off Variable, cooling water

It is a function to adjust the cooling water temperature Thermal On / Off temperature according to the field environment in preparation for cooling or cooling claim.

- You can set the following setting values using [<, >(left/right)] button.

|                                   |      |         |
|-----------------------------------|------|---------|
| Installer                         | Back | OK      |
| TH on/off Variable, heating air   | <    | Type0 > |
| TH on/off Variable, heating water | <    | Type0 > |
| TH on/off Variable, cooling air   | <    | Type0 > |
| TH on/off Variable, cooling water | <    | Type0 > |
| Pump setting in heating           |      |         |

| Value | Description |         |
|-------|-------------|---------|
|       | TH On       | TH Off  |
| Type0 | 0.5 °C      | -0.5 °C |
| Type1 | 1 °C        | -1 °C   |
| Type2 | 2 °C        | -2 °C   |
| Type3 | 3 °C        | -3 °C   |

## Heating temp. setting

- At the leaving water control in heating mode, the control reference water temperature position setting
- If the air / leaving water temperature selection setting is set to leaving water temperature
- Change setting values using [ $\leftarrow$ , $\rightarrow$ ](left/right) button

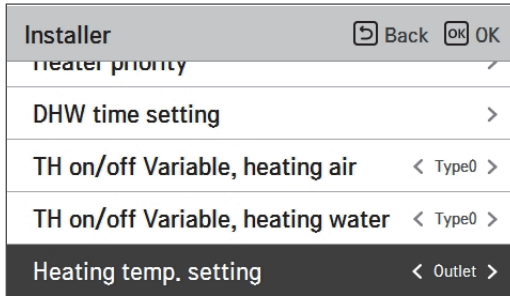

| Value            |       |
|------------------|-------|
| Outlet (Default) | Inlet |

## Cooling temp. setting

- At the leaving water control in cooling mode, the control reference water temperature position setting
- If the air / leaving water temperature selection setting is set to leaving water temperature
- Change setting values using [**<**,**>**(left/right)] button

| Installer                         |   | Back   | OK |
|-----------------------------------|---|--------|----|
| Drw time setting                  |   |        |    |
| TH on/off Variable, heating air   | < | Type0  | >  |
| TH on/off Variable, heating water | < | Type0  | >  |
| Heating temp. setting             | < | Outlet | >  |
| Cooling temp. setting             | < | Outlet | >  |

| Value            |       |
|------------------|-------|
| Outlet (Default) | Inlet |

## Pump setting in heating

- It is a function to help the water pump's mechanical life by putting the water pump's rest time
- Installer setting function to set water pump operation / delay time option in heating mode
- In the installer setting list, select Pump setting in heating category, and press [OK] button to move to the detail screen.

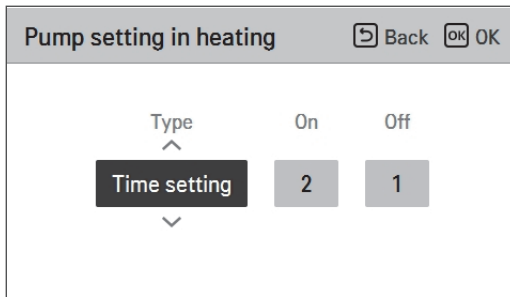
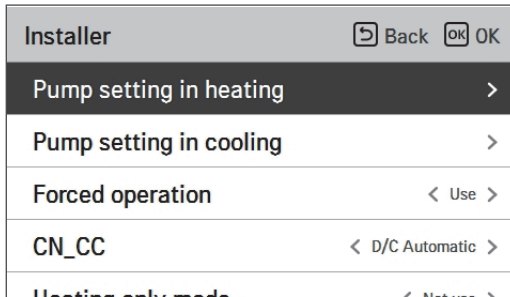

| Type | Time setting          | Operation continue |
|------|-----------------------|--------------------|
| On   | 1 Minute ~ 60 minutes | -                  |
| Off  | 1 Minute ~ 60 minutes | -                  |

## Pump setting. in cooling

- It is a function to help the water pump's mechanical life by putting the water pump's rest time
- installer setting function to set water pump operation / delay time option in cooling mode
- In the installer setting list, select Pump setting in cooling category, and press [OK] button to move to the detail screen.

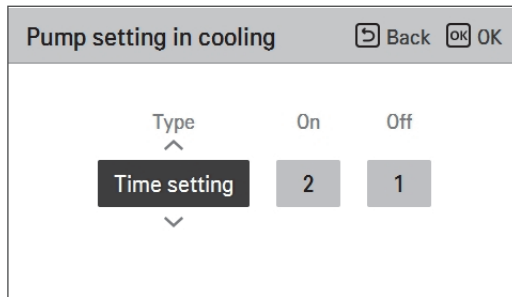
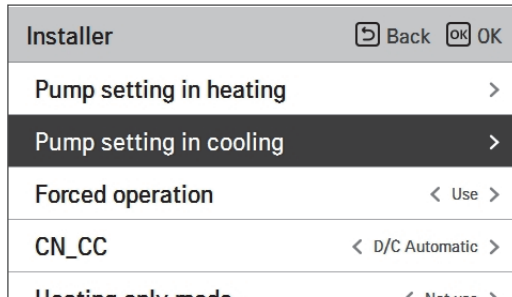

| Type | Time setting          | Operation continue |
|------|-----------------------|--------------------|
| On   | 1 Minute ~ 60 minutes | -                  |
| Off  | 1 Minute ~ 60 minutes | -                  |

## Forced operation

- If the product is not used for a long time, the product will be forced to operate to prevent pump failure and PHEX freezing
- Water pump off After 20 consecutive hours, disable / enable the logic that drives the water pump by itself
- In the installer setting list, select Forced operation category, and press [OK] button to move to the detail screen

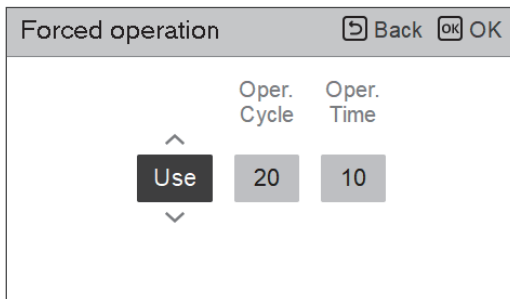
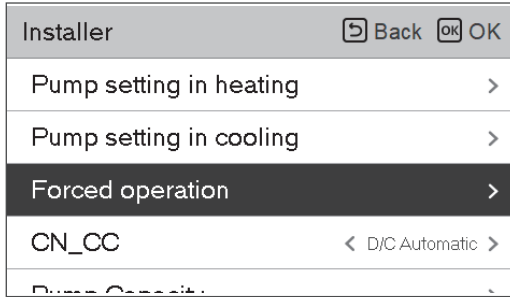

| Type        | Use                     | Not use |
|-------------|-------------------------|---------|
| Oper. Cycle | 20 minutes ~ 60 minutes | -       |
| Oper. Time  | 1 Minute ~ 60 minutes   | -       |

## CN\_CC

It is the function to set the usage of the unit's CN\_CC port.

- Change setting values using [<,>(left/right)] button

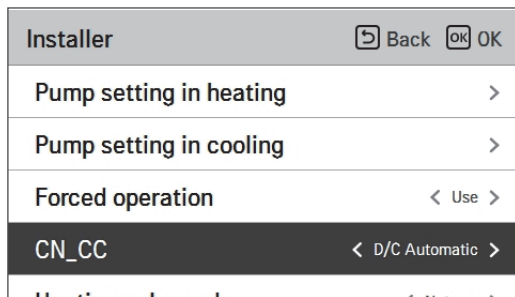

| Value             | Description  |
|-------------------|--|
| D/C Automatic     | When power is applied to the product, the unit when the contact point is on in Dry Contact installed state recognizes Dry Contact installation |
| D/C Not Installed | Do not use (install) Dry Contact   |
| D/C Installed     | Use (install) Dry Contact  |

### NOTE

CN\_CC is the device connected to the unit to recognize and control the external contact point.

## Pump Capacity

It is a function to enable installer to control Pump capacity application model.

- In the installer setting list, select Pump Capacity category, and press [OK] button to move to the detail screen.
- $\Delta T$  Control
  - This function automatically adjusts the pump capacity during heating operation. Automatically adjusts between the pump set volume and the minimum pump volume.
  - Minimum pump capacity will change from 40 % (Default) to suit the installation environment.

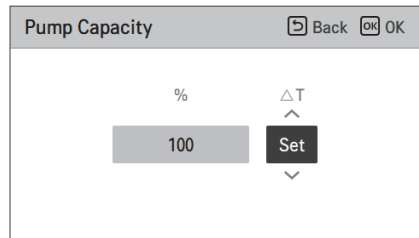
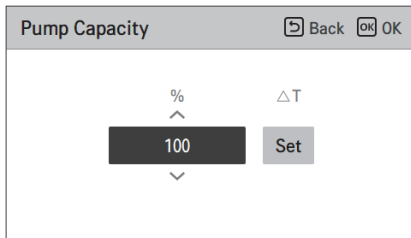
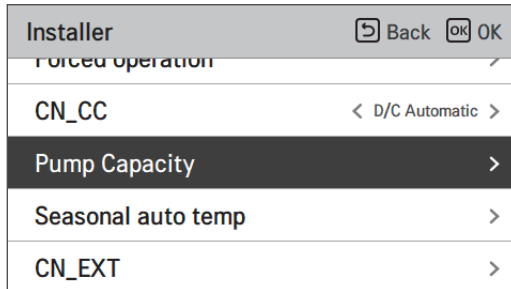

| Value         | Description                  |
|---------------|------------------------------|
| 100 (Default) | 10~100 : %<br>Change unit: 5 |

## Seasonal auto temp

It is the function to set the operation reference value in Seasonal Auto mode.

- In the installer setting list, select Seasonal auto temp category, and press [OK] button to move to the detail screen.

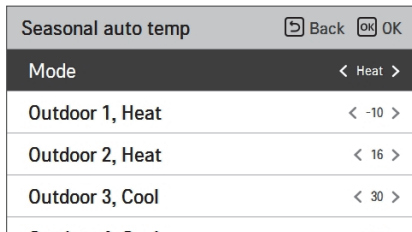
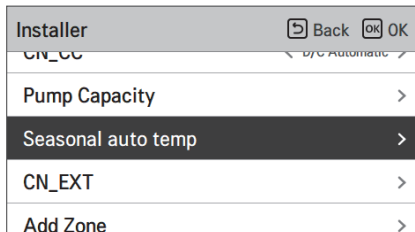

| Function             | Description                 | Range   |             | Default | Boundary                         |
|----------------------|-----------------------------|---|-------------|---------|----------------------------------|
|                      |                             | For R410A   | For R32     |         |                                  |
| Outdoor1,Heat (Out1) | Heating lower ambient temp  | -25 ~ 35 °C   | -15 ~ 24 °C | -10 °C  | Out1 ≤ Out2-1                    |
| Outdoor2,Heat (Out2) | Heating higher ambient temp |   |             | 16 °C   | Out2 ≥ Out1 +1<br>Out2 ≤ Out3 -5 |
| Outdoor3,Cool (Out3) | Cooling lower ambient temp  | 10 ~ 46 °C  | 10 ~ 43 °C  | 30 °C   | Out3 ≥ Out2 +5<br>Out3 ≤ Out4 -1 |
| Outdoor4,Cool (Out4) | Cooling higher ambient temp |   |             | 40 °C   | Out4 ≥ Out3 +1                   |
| Water1,Heat (LW1)    | Heating higher water temp   | Use heater :<br>LW STD : 15~65 °C<br>EW STD : 15~55 °C<br>Not use heater :<br>LW STD : 20~65 °C<br>EW STD : 20~55 °C  | 15 ~ 57 °C  | 35 °C   | LW1 ≤ LW2                        |
| Water 2,Heat (LW2)   | Heating lower water temp    |   |             | 28 °C   | LW2 ≤ LW1                        |
| Water3,Cool (LW3)    | Cooling higher water temp   | Use FCU & 5 °C<br>IDU :<br>LW STD : 5~27 °C<br>EW STD : 10~27 °C<br>Use FCU & 6 °C<br>IDU :<br>LW STD : 6~27 °C<br>EW STD : 11~27 °C<br>Not use FCU :<br>LW STD : 16~27 °C<br>EW STD : 20~27 °C | 5 ~ 25 °C   | 20 °C   | LW3 ≤ LW4                        |
| Water4,Cool (LW4)    | Cooling lower water temp    |   |             | 16 °C   | LW4 ≤ LW3                        |
| Air 1, Heat (RA1)    | Heating higher air temp     | 16 ~ 30 °C  | 16 ~ 30 °C  | 30 °C   | RA1 ≤ RA2                        |
| Air 2, Heat (RA2)    | Heating lower air temp      |   |             | 26 °C   | RA2 ≤ RA1                        |
| Air 3, Cool (RA3)    | Cooling higher air temp     | 18 ~ 30 °C  | 18 ~ 30 °C  | 22 °C   | RA3 ≤ RA4                        |
| Air 4, Cool (RA4)    | Cooling lower air temp      |   |             | 18 °C   | RA4 ≤ RA3                        |

- Setting range: Celsius
- Seasonal Auto Driving mode: Heating, Heating & Cooling, Air-conditioning
- \* If heating mode is selected, heating & cooling or cooling can not be selected.
- Depending on the air / outflow control selection value, the water / air related setting value is displayed on the screen.

In this mode, setting temperature will follow outdoor temperature automatically. This mode adds the cooling season function to the conventional weather dependent operation mode.

|         | Auto-Adjustable Target Temp. | Room Air Temp.( °C) | Leaving Water Temp. | Outdoor Air Temp. |           |
|---------|------------------------------|---------------------|---------------------|-------------------|-----------|
| Heating | Set point 1                  | 30~20               | 57~39               | Set point 5       | -20 ~ -10 |
|         | Set point 2                  | 19~16               | 38~20               | Set point 6       | -5 ~ 5    |
| Cooling | Set point 3                  | 30~24               | 25~17               | Set point 7       | 10 ~ 18   |
|         | Set point 4                  | 23~18               | 16~6                | Set point 8       | 22 ~ 30   |

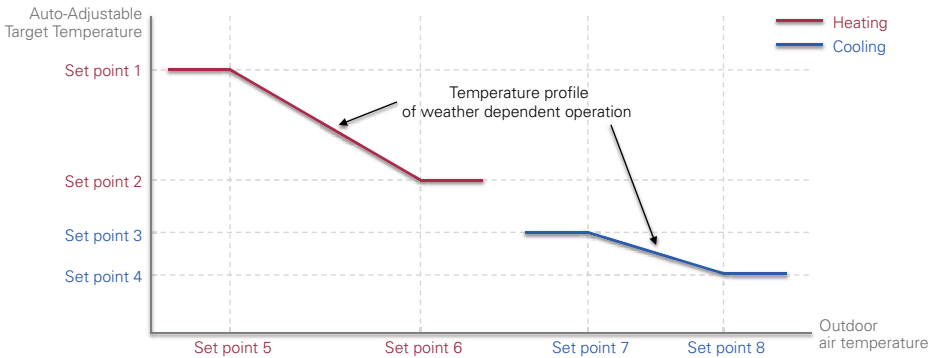

## Modbus Address

It is function to set the address of the Modbus device that is externally linked to the product. Modbus address setting function is available from indoor unit.

- In the installer setting list, select Modbus Address , and press [OK] button to move to the detail screen.

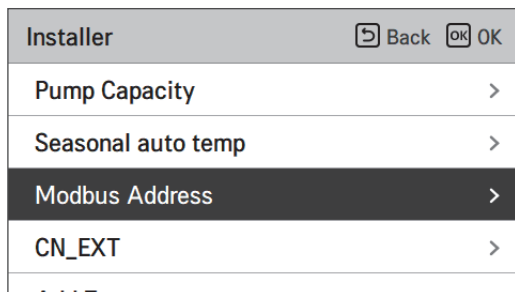

### NOTE

To use this function, switch No.1 of option switch 1 must be turned ON.

## CN\_EXT

It is a function to control external input and output according to DI type set by customer using CN-EXT Port.

- In the installer setting list, select CN-EXT Port category, and press [OK] button to move to the detail screen.

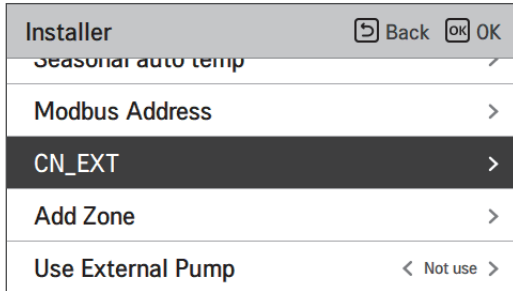

| Value   |                  |                    |                       |
|---------|------------------|--------------------|-----------------------|
| Not use | Simple Operation | Simple Dry Contact | Single emergency stop |

## Anti-freezing Temperature

Anti-freeze temperature setting is available in installer mode. It prevents frostbite from happening in the range of -25 to -5 degree celsius.

- Change setting values using [

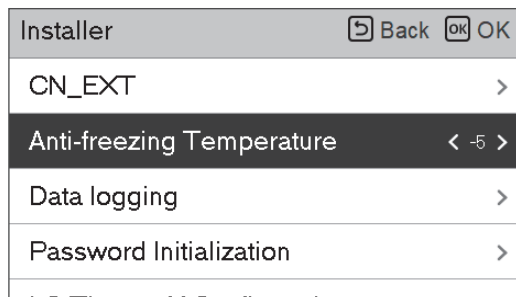

### NOTE

To use this function, the antifreeze short pin (CN\_FLOW2, Black) of indoor PCB must be removed and switch No.2 in option SW 3 must be on.

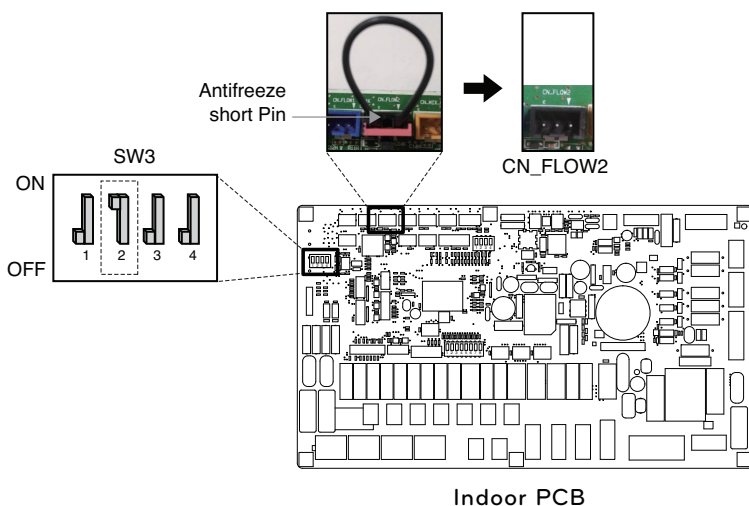

## Add Zone

Function to set whether or not to use an installed 2nd circuit function using mixing kit.

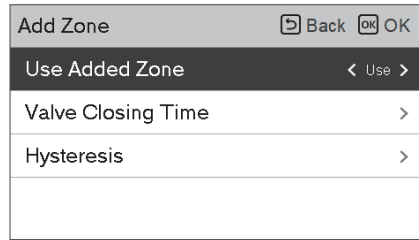
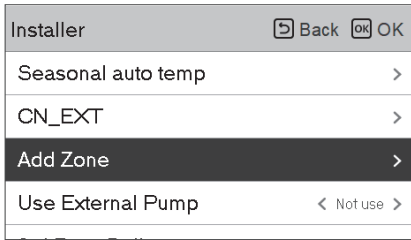

You can set valve closing time[seconds] and hysteresis temperature[ °C] on screen by yourself.

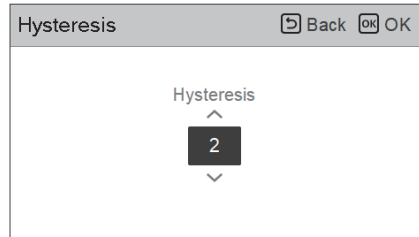
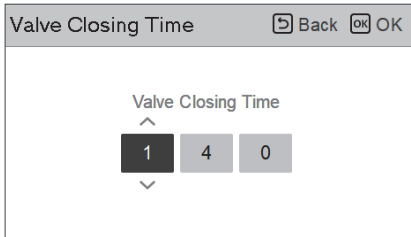

Activating this function, It allows 2 zones(Room1, Room2) temperature to be controlled, separately.

- In case of heating, the temperature of Room1 can not be set higher than Room2 temperature.
- In case of cooling, the temperature of Room1 can not be set lower than Room2 temperature.

### Setting range

- Add Zone (2nd Circuit function setting) : Use / Not Use
- Value Closing Time : 60 ~ 999 seconds (Default: 240)
- Hysteresis (Thermal On / Off) : 1 ~ 5 °C (Default: 2)

## Use External Pump

This function can be set to control the external water pump.

- In the installer setting list, select Use External Pump category, and press [OK] button to move to the detail screen.
- Heating/Cooling  
You can use this feature when you have installed a 3 Way valve to switch the water flow between the underfloor and the water tank. The external pump operates only in the direction of water flow in the underfloor.

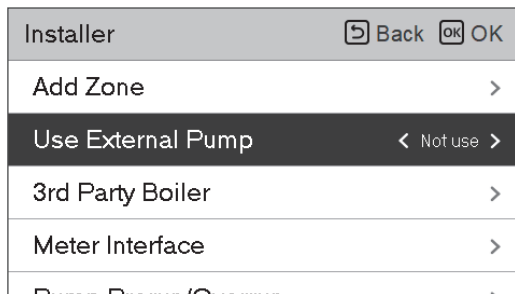

| Value   |     |                 |
|---------|-----|-----------------|
| Not use | Use | Heating/Cooling |

### 3rd Party Boiler

This function is to configure the 3rd party boiler to be controlled.

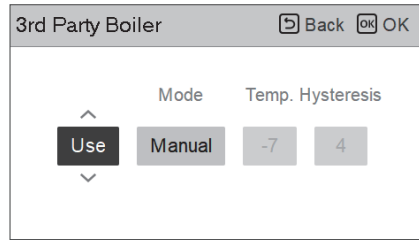
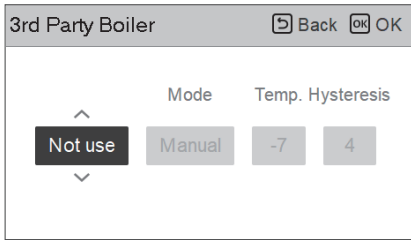

If the status of this function is "Use", you can choose control mode of boiler, Auto or Manual.

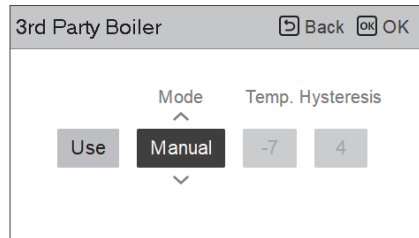
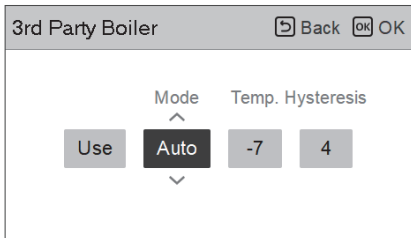

If the mode of this function is set to "Manual", you can set temperature of the boiler and hysteresis, respectively.

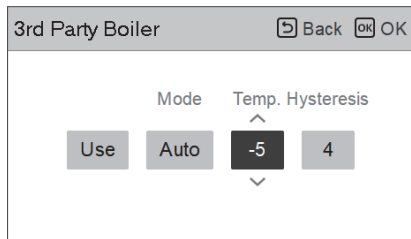

External boiler ON condition :

- If outdoor temperature  $\leq$  external boiler operation temperature value (installer setting), turn off the indoor unit and operate the external boiler.

External boiler OFF condition :

- If External air temperature  $\geq$  external boiler operation temperature value (installer setting) + Hysteresis (installer setting), turn off external boiler operation and operate indoor unit

## Meter Interface

It is the function that can check the status of energy and power on screen. It collects and calculates power or calorie data to create data for energy monitoring and energy warning alarm pop-ups. This function can be activated in installer mode.

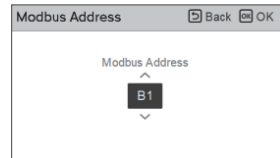
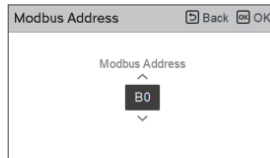
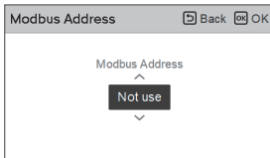
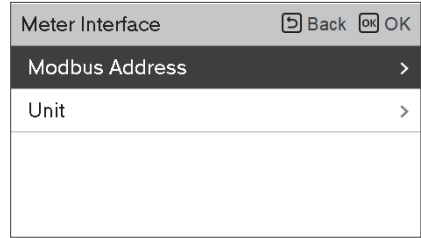
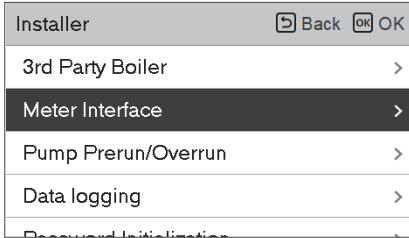

There are 2 options, modbus address and unit, in this function. Activating the modbus address option, you choose one address(B0 or B1) or don't use. Then, you set the port and specification in range of 0000.0~9999.9 [pulse/ kWh] as shown in the figure below.

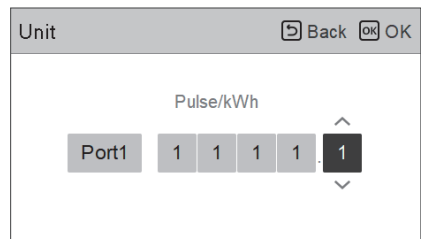
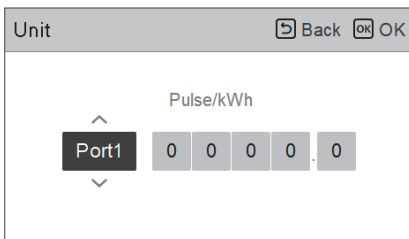

## Pump Prerun/Overrun

Pump Prerun operates to ensure sufficient flow before the compressor is operated. This is a function that allows heat exchange to work smoothly.

Pump Overrun is a function to prevent water pump failure and to help mechanical life. If the water pump has been off for 20 hours, Water pump will operate for the set time

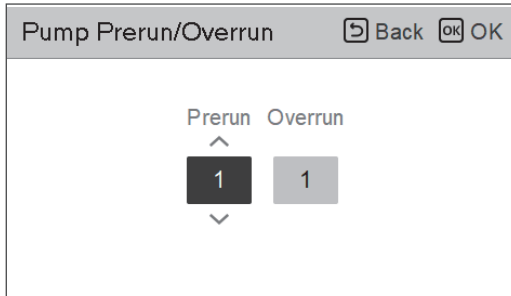
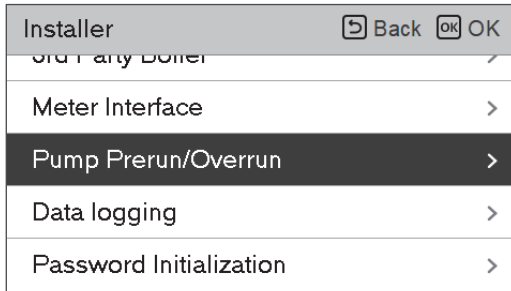

| Value   | Default | Setting Range |
|---------|---------|---------------|
| Prerun  | 1 min   | 1~10 min      |
| Overrun | 10 min  | 1~10 min      |

## Solar Thermal System

It is function to set operation reference value in Solar Thermal System.

In the installer setting list, select Solar thermal system category, and press [OK] button to move to the detail screen.

Installer [Back] [OK]

- IDU operation time >
- Solar Thermal System >**
- Data logging >
- Password Initialization >
- LC Thermal Configuration >

Solar Thermal System [Back] [OK]

- Solar collector set temp >**
- DHW set temp. >
- TH on/off Variable, solar >
- Boost Heater >
- Solar pump flush schedule >

Solar collector set temp [Back] [OK]

Min. Max.

10 95

DHW set temp. [Back] [OK]

Max.

80

TH on/off Variable, solar [Back] [OK]

Temp OnTemp Off

8 2

Boost Heater [Back] [OK]

Boost Heater

Enable

Solar pump flush schedule [Back] [OK]

| Control | Start Hour | Start Minute | End Hour | End Minute |
|---------|------------|--------------|----------|------------|
| On      | 06         | 00           | 18       | 00         |

Solar pump flush setting [Back] [OK]

| Oper. Cycle | Oper. Time |
|-------------|------------|
| 60          | 1          |

Solar pump test run [Back] [OK]

Solar pump test run

Stop

### NOTE

To use this function, switch No.2 of option switch 2 must be turned ON and No.3 of option switch 2 must be turned OFF.

**Descriptions for each parameters are as following.**

- Solar collector set temp
  - Min temp : It is the minimum solar collector temperature at which the solar thermal system can operate.
  - Max temp : It is the maximum solar collector temperature at which the solar thermal system can operate
- TH on/off Variable, solar
  - Temp on : It is the temperature difference between the current solar thermal temperature and DHW tank temperature at which the solar thermal system operates.
  - Temp off : It is the temperature difference between the current solar thermal temperature and DHW tank temperature at which the solar thermal system stops.
  - Example : If the current solar collector temperature is 80 °C and Temp on is set to 8 °C, the solar thermal system operates when the DHW tank temperature is less than 72 °C. In the same case, if Temp off is set to 2 °C, Solar Thermal System stops when DHW temperature is 78 °C.
- DHW Set Temp
  - Max : It is maximum temperature of DHW that can be reached by solar thermal system.
- Boost Heater
  - Enable : DHW tank heater can be used when operating the Solar Thermal system.
  - Disable : DHW tank heater cannot be used when operating the Solar Thermal system.
- Solar pump flush schedule
  - It is the function to circulate the solar water pump intermittently for solar collector temperature detection when the solar water pump does not operate for a long time. Turn on to use this function.
- Solar Pump flush setting
  - Oper.Cycle : When using the solar pump flush function, the solar water pump operates at the set time.
  - Oper.Time : When using the solar pump flush function, the solar water pump operates during the set time.

| Function                  | Value                    | Range            | Default |
|---------------------------|--------------------------|------------------|---------|
| Solar collector set temp  | Min                      | 5 °C ~ 50 °C     | 10 °C   |
|                           | Max                      | 60 °C~105 °C     | 95 °C   |
| DHW set temp              | Max                      | 20 °C~90 °C      | 80 °C   |
| TH on/off Variable, solar | Temp On                  | 3 °C ~ 40 °C     | 8 °C    |
|                           | Temp Off                 | 1 °C ~ 20 °C     | 2 °C    |
| Boost Heater              | Boost Heater             | Enable/Disable   | Enable  |
| Solar pump flush schedule | On/OFF                   | On/Off           | On      |
|                           | Start Hour, Start Minute | 00:00 ~ 24:00    | 6:00    |
|                           | End Hour, End Minute     | 00:00 ~ 24:00    | 18:00   |
| Solar pump test run       | Pump test Run            | Start/Stop       | Stop    |
| Solar pump flush setting  | Oper.Cycle               | 30 min ~ 120 min | 60 min  |
|                           | Oper.Time                | 1 min ~ 10 min   | 1 min   |

## Energy state

This function is to control the product according to the energy state. When the charged state of ESS is transmitted, it changes the target temperature of heating, cooling and DHW by setting value according to energy state.

Select either Signal Mode or Modbus Mode according to the connection type between the product and the ESS.

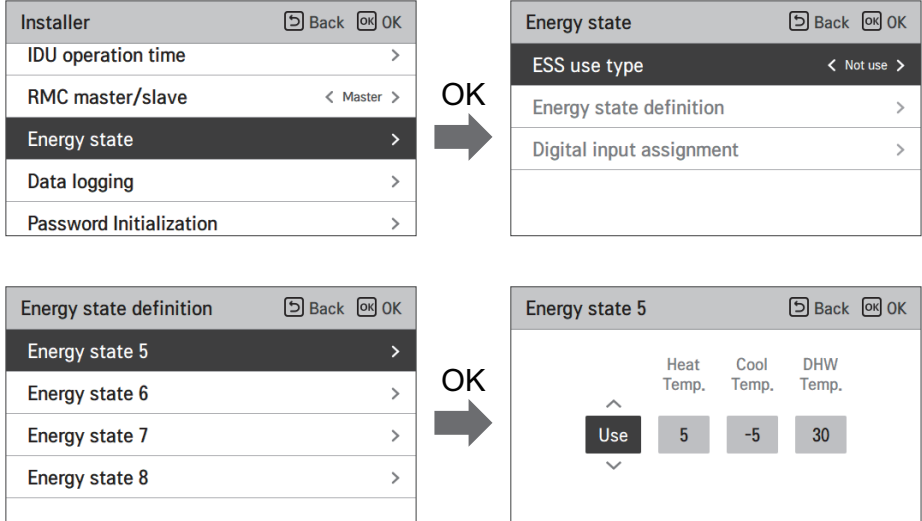

When Signal Mode of EES use type is selected, press the Digital Input Assignment button to set the energy state according to the input signal.

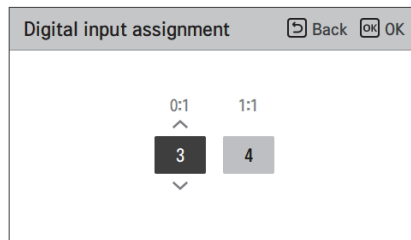

| Value | Input Signal |        | Output state |         |
|-------|--------------|--------|--------------|---------|
|       | TB_SG1       | TB_SG2 | Default      | Range   |
| X     | 0            | 0      | ES2          | fixed   |
| X     | 1            | 0      | ES1          | fixed   |
| 0:1   | 0            | 1      | ES3          | ES3-ES8 |
| 1:1   | 1            | 1      | ES4          |         |

## Data logging

It is the function to set the operation reference value in Seasonal Auto mode.

- In the installer setting list, select Data logging category, and press [OK] button to move to the detail screen.

| Installer                   |   | Back | OK |
|-----------------------------|---|------|----|
| Heating only mode           |   |      |    |
| Pump frequency setting(PWM) | > |      |    |
| Smart Grid(SG)              | > |      |    |
| Seasonal auto temp          | > |      |    |
| <b>Data logging</b>         | > |      |    |



| Data logging |       | Back  |         |           |
|--------------|-------|-------|---------|-----------|
| Date         | Time  | Oper. | Settemp | In/Out    |
| 1970.01.01   | 00:10 | Off   | -       | 24° / 25° |
| 1970.01.01   | 00:09 | Off   | -       | 24° / 25° |
| 1970.01.01   | 00:09 | Off   | -       | 24° / 25° |
| 1970.01.01   | 00:09 | Off   | -       | 24° / 25° |
| 1970.01.01   | 00:09 | Off   | -       | 24° / 25° |

### NOTE

Error history lookup range: 50

Error history information

Item: date, time, mode (including Off), set temperature, incoming temperature, outgoing temperature, room temperature, Hot water operation / stop, Hot water set temperature, Hot water temperature, Outdoor unit On / Off, Error code

Number of Display: Within 50

- Save criteria ▾

- ▾ Error occurred, released
- ON / OFF of outdoor unit operation

## Password Initialization

It is the function to initialize (0000) when you forgot the password set in the remote controller.

- In the installer setting list, select the password initialization setting category, and press [OK] button to move to the detail screen.
- When you press “initialization” button, a popup screen appears, and when you press “check” button, password initialization starts, and the user password is changed to 0000.

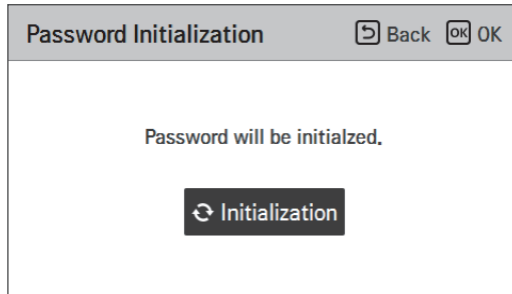
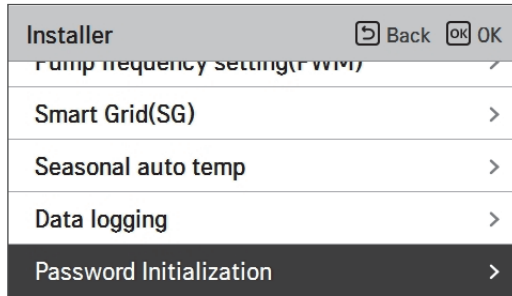

# Overview settings (For 3 Series)

## Menu Structure

|      |                                       |          |
|------|---------------------------------------|----------|
| Menu |                                       |          |
|      | Sub function                          |          |
|      | Service Contact                       | .....124 |
|      | Model information                     | .....125 |
|      | RMC Version Information               | .....126 |
|      | Open Source License                   | .....127 |
|      | Installer                             |          |
|      | 3 Minutes Delay                       | .....131 |
|      | Select Temperature Sensor             | .....132 |
|      | Dry Contact Mode                      | .....133 |
|      | Central Control Address               | .....134 |
|      | Pump test run                         | .....135 |
|      | Air cooling set temp.                 | .....136 |
|      | Water cooling set temp                | .....137 |
|      | Air heating set temp.                 | .....138 |
|      | Water heating set temp                | .....139 |
|      | DHW set temp                          | .....140 |
|      | Screed drying                         | .....141 |
|      | Heater on temperature                 | .....143 |
|      | Water supply off temp. during cooling | .....145 |
|      | Tank disinfection setting 1, 2        | .....147 |
|      | Tank setting 1                        | .....148 |
|      | Tank setting 2                        | .....149 |
|      | Heater priority                       | .....151 |
|      | DHW time setting                      | .....152 |
|      | TH on/off Variable, heating air       | .....153 |
|      | TH on/off Variable, heating water     | .....154 |

|   |                                   |       |     |
|---|-----------------------------------|-------|-----|
| → | TH on/off Variable, cooling air   | ..... | 155 |
| → | TH on/off Variable, cooling water | ..... | 156 |
| → | Heating temp. setting             | ..... | 157 |
| → | Cooling temp. setting             | ..... | 158 |
| → | Pump setting in heating           | ..... | 159 |
| → | Pump setting. in cooling          | ..... | 160 |
| → | Forced operation                  | ..... | 161 |
| → | CN_CC                             | ..... | 162 |
| → | Pump Capacity                     | ..... | 163 |
| → | Seasonal auto temp                | ..... | 164 |
| → | Modbus Address                    | ..... | 166 |
| → | CN_EXT                            | ..... | 167 |
| → | Anti-freezing Temperature         | ..... | 168 |
| → | Add Zone                          | ..... | 169 |
| → | Use External Pump                 | ..... | 170 |
| → | 3rd Party Boiler                  | ..... | 171 |
| → | Meter Interface                   | ..... | 172 |
| → | Pump Prerun/Overrun               | ..... | 173 |
| → | Solar Thermal System              | ..... | 174 |
| → | Energy state                      | ..... | 176 |
| → | Data logging                      | ..... | 177 |
| → | Password Initialization           | ..... | 178 |
| → | Overview settings                 | ..... | 179 |

## Installer setting (For 4 Series)

- You can set the product user functions.
- Some functions may not be displayed/operated in some product types.

| Segmentation     | Functions                     | Description  |
|------------------|-------------------------------|--|
| Configuration    | Select Temperature Sensor     | Selection for setting temperature as air temperature or leaving water temperature or air + leaving water temperature   |
|                  | Use Heating Tank Heater       | Set up to control booster heater   |
|                  | Mixing Circuit                | This function is to use mixing circuit function. Set enable/disable mixing circuit function and valve closing time and hysteresis.   |
|                  | Use External Pump             | Set up to control an external water pump   |
|                  | RMC master/slave              | Function to use 2 remote control environment   |
|                  | LG Therma V Configuration     | Function to save the environment settings of the product for use in LG Therma V Configurator through SD Card.  |
| General settings | Forced operation              | Water pump off After 20 consecutive hours, disable / enable the logic that drives the water pump by itself   |
|                  | Pump Prerun/Overrun           | Set to reach the optimum flow rate by circulating the heating water with the water pump before heat exchange. After the operation stop, additional water pump is activated to circulate the heating water. |
|                  | Water Flow Control            | Set water pump to control the water flow   |
|                  | Energy Monitoring             | Set up to use energy monitoring function of unit   |
|                  | Anti-Freezing Operation       | This function is to turn on/off the freeze prevention operation of the pump when the remote control is off.  |
|                  | Password Reset                | It is the function to initialize (0000) the password when you forgot the password set in the remote controller.  |
| Room Heating     | Heating temp. setting         | At the water control in heating mode, the control reference water temperature position setting   |
|                  | Air heating set temp.         | Adjusting range of 'Setting Air Temperature' in heating mode   |
|                  | Water heating set temp.       | Adjusting range of 'Setting Heating Flow Temperature' in heating mode  |
|                  | Hysteresis Heating Water      | Heating Water Outlet Temperature Hysteresis range setting  |
|                  | Hysteresis Room Air (Heating) | Heating air temperature Hysteresis range setting   |
|                  | Pump setting in heating       | Set water pump on/off interval option during thermo off condition in heating mode  |
|                  | Heater on temperature         | Setting outdoor air temperature where half capacity of backup heater starts operation.   |
|                  | Screed drying                 | This function controls floor heating to a specific temperature for a certain period of time to cure floor cement   |

| Segmentation       | Functions                             | Description  |
|--------------------|---------------------------------------|--|
| Room Cooling       | Cooling temp. setting                 | At the water control in cooling mode, the control reference water temperature position setting   |
|                    | Air cooling set temp.                 | Adjusting range of 'Setting Air Temperature' in cooling mode   |
|                    | Water cooling set temp.               | Adjusting range of 'Setting Leaving Water Temperature' in cooling mode   |
|                    | Water supply off temp. during cooling | Determine the leaving water temperature which blocks the flow into underfloor coil in cooling mode. This function is used for preventing condensation on the floor in cooling mode |
|                    | Hysteresis Cooling Water              | Cooling Water Outlet Temperature Hysteresis range setting  |
|                    | Hysteresis Room Air (Cooling)         | Cooling air temperature Hysteresis range setting   |
|                    | Pump setting in cooling               | Set water pump on/off interval option during thermo off condition in cooling mode  |
| Auto mode          | Seasonal auto temp                    | Set the operating temperature in Seasonal Auto mode  |
| Domestic hot water | DHW set temp.                         | Setting DHW set temperature  |
|                    | Tank disinfection setting 1           | Setting start/maintain time for disinfection   |
|                    | Tank disinfection setting 2           | Setting disinfection temperature   |
|                    | Tank setting 1                        | Setting minimum and maximum temperature using heat pump cycle for DHW heating  |
|                    | Tank setting 2                        | Setting temperature hysteresis and heating priority (DHW heating or floor heating)   |
|                    | Heater priority                       | Determine usage of backup heater and booster heater  |
|                    | DHW time setting                      | Determine follow time duration : operation time of domestic hot water tank heating, stop time of domestic hot water tank heating, and delay time of DHW tank heater operating      |
|                    | Recirculation time                    | Whether to use the recirculation function and set the water pump on/off interval option  |
| Solar thermal      | Solar Thermal System                  | Function to set operation reference value in Solar Thermal System.   |
| Service            | Pump test run                         | Water pump test run  |
|                    | Frost Protection Temp.                | This function is to apply an offset to the freezing temperature of the freeze protection logic when using antifreeze mode  |

| Segmentation | Functions               | Description   |
|--------------|-------------------------|---|
| Connectivity | Dry Contact Mode        | Dry contact function is the function that can be used only when the dry contact devices is separately purchased and installed.  |
|              | Central Control Address | When connecting the central control, set the central control address of the unit.   |
|              | CN_CC                   | It is the function to set whether to install (use) Dry Contact. (It is not a function for Dry Contact installation, but it is a function to set the usage of the unit's CN_CC port.)                        |
|              | CN_EXT                  | Function to set external input and output control according to DI / DO set by customer using dry contact port of indoor unit. Determine the use of the contact port (CN_EXT) mounted on the indoor unit PCB |
|              | 3rd Party Boiler        | Configuration to control 3rd party boiler   |
|              | Meter Interface         | When installing the meter interface to measure energy / calorie in the product, set unit spec for each port   |
|              | Energy state            | Select whether to use or not use the SG Mode function of the product, set the operation option value in SG1 step.   |
|              | Thermostat control type | Setting Thermostat control type   |
|              | Modbus Address          | It is function to set the address of the Modbus device that is externally linked to the product. Modbus address setting function is available from indoor unit.   |
| Info         | Pump operation time     | Display water pump's operation time   |
|              | IDU operation time      | Display Indoor Unit's operation time  |
|              | Current Flow Rate       | Function to check the current flow rate.  |
|              | Data logging            | Display error and operation history of connected unit   |

## Select Temperature Sensor

The product can be operated according to air temperature or water temperature. The selection for setting temperature as air temperature or water temperature is determined.

- In the installer setting list, Select Temperature Sensor category, and press [OK] button to move to the detail screen.

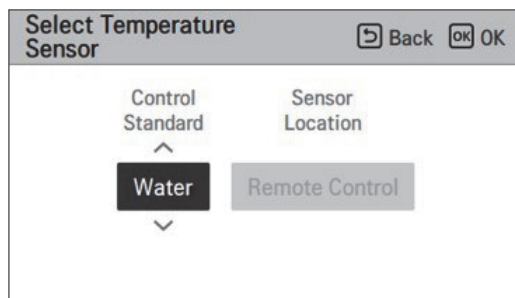
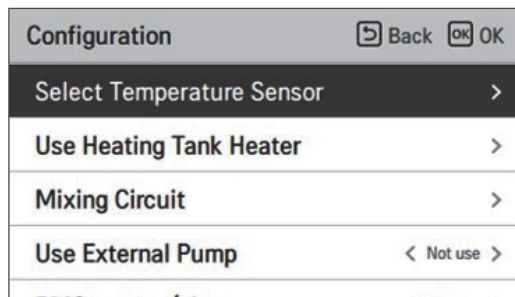

| Type            | Value          |             |
|-----------------|----------------|-------------|
| Water (Default) | Remote Control |             |
| Air             | Remote Control | Indoor Unit |
| Air+Water       | Remote Control | Indoor Unit |

### NOTE

Air temperature as setting temperature is ONLY available when Remote Air Sensor Connection is enabled and Remote Air Sensor Connection is set as 02.

## Use Heating Tank Heater

This is a function to change the set value for the operation of the hot water tank heater, such as heating tank heater use /not use and heater delay time.

- In the installer setting list, Select Configuration category, and press [OK] button to move to the detail screen.

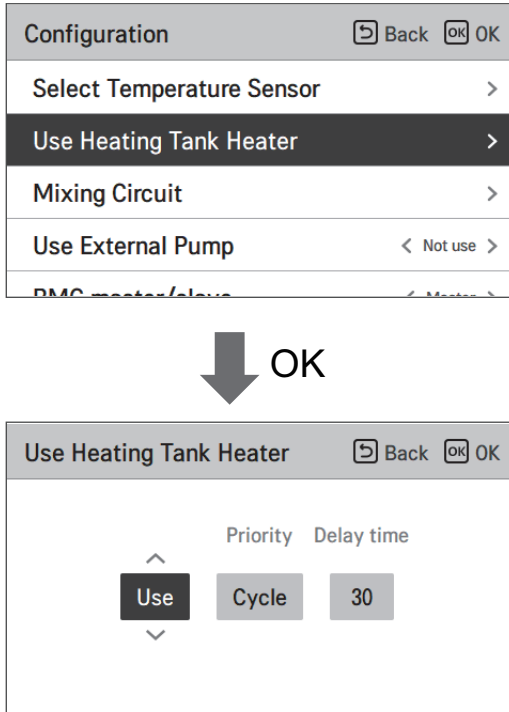

### Setting value

- Functions : Use, Not use, Use disinfect (Default : Use)
- Priority : Cycle, Heater/Cycle (Default : Cycle)
- Delay time : 10/20/30/40/50/60/90/120/1440 minute (Default : 30)

## Mixing Circuit

Function to set whether or not to use a installed mixing circuit function using mixing kit.

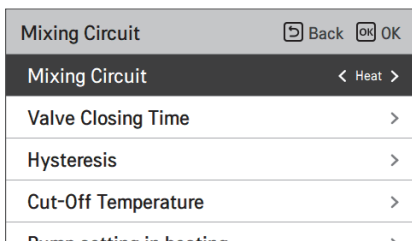
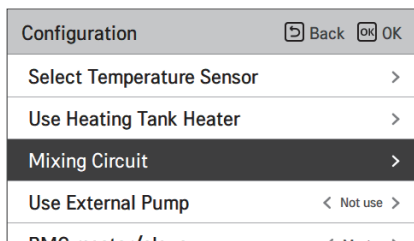

You can set valve closing time[s] and hysteresis temperature[°C] on screen by yourself. Setting the cut-off temperature protects the water from flowing over the cut-off temperature in the mixing circuit during heating operation.

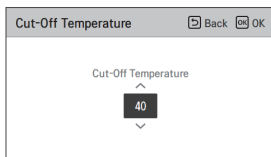
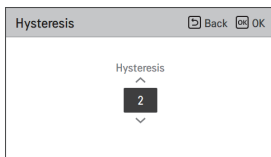
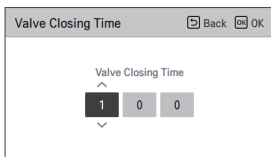

Installer setting function to set water mixing pump operation / delay time option in heating/cooling mode

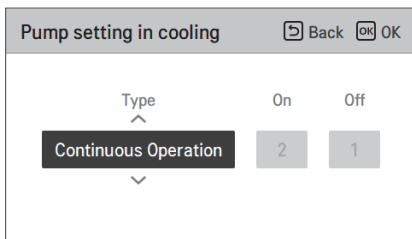
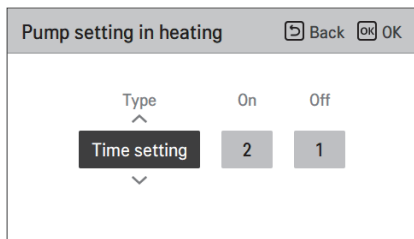

Activating this function, It allows 2 zones(Room1, Room2) temperature to be controlled, separately.

Setting range

- Mixing Circuit (2nd Circuit function setting) : Not Use / Heat / Heat & Cool
- Value Closing Time : 60 ~ 999 s (Default: 240)
- Hysteresis (Thermal On / Off) : 1~3 °C (Default: 2)

### NOTE

When using the Mixing Circuit function, the external pump setting must be changed to 'Circuit 1'.

## Use External Pump

This function can be set to control the external water pump.

- In the installer setting list, select Use External Pump category, and press [OK] button to move to the detail screen.
- Heating/Cooling  
You can use this feature when you have installed a 3 Way valve to switch the water flow between the underfloor and the water tank. The external pump operates only in the direction of water flow in the underfloor.
- Circuit1  
This function controls the external pump when operating the mixing circuit. The external pump should be controlled according to Th/on and Th/off in Circuit1(Direct circuit). Therefore, when using the mixing circuit, be sure to set the external pump to 'Circuit1'.

|                           |             |
|---------------------------|-------------|
| <b>Configuration</b>      | Back OK     |
| Use heating tank heater   | >           |
| Mixing Circuit            | >           |
| <b>Use External Pump</b>  | < Not use > |
| RMC master/slave          | < Master >  |
| LG Therma V Configuration | >           |

| Value             |     |             |          |
|-------------------|-----|-------------|----------|
| Not use (Default) | Use | Heat & Cool | Circuit1 |

## RMC master/slave

This function can be select Master/Slave on remote controller to use 2 Remote Control environment

- In the Installer setting list, and select RMC master/slave setting category, and press [<,>(left/right)] button to following setting values.

| Configuration             |             | Back | OK |
|---------------------------|-------------|------|----|
| Use heating tank heater   |             |      | >  |
| Mixing Circuit            |             |      | >  |
| Use External Pump         | < Not use > |      |    |
| <b>RMC master/slave</b>   | < Master >  |      |    |
| LG Therma V Configuration |             |      | >  |

| Value            |       |
|------------------|-------|
| Master (Default) | Slave |

## LG Therma V Configuration

This function can be set to save the environment settings of the product for use in LG Therma V Configurator through SD Card.

- In the Installer setting list, and select LG Therma V Configuration setting category, and press [OK] button to move to the detail screen.

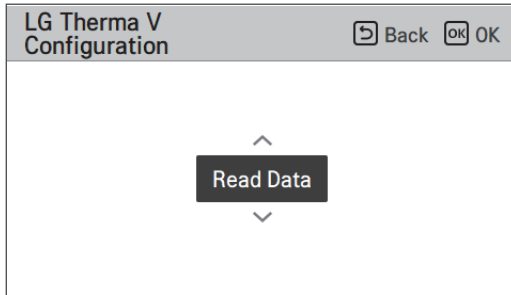
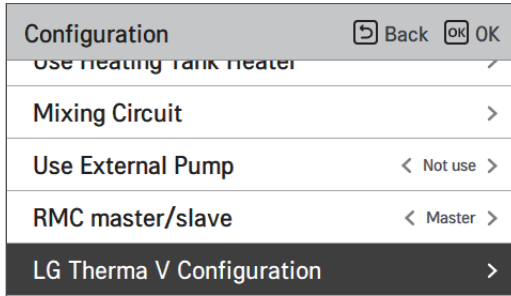

| Value               |           |
|---------------------|-----------|
| Read Data (Default) | Save Data |

### NOTE

When saving the environment setting of the product in the SD card, be sure to save the file name as 'RS3\_AWHP\_DATA'.

## Forced operation

- If the product is not used for a long time, the main water pump will be forced to operate for preventing pump failure and PHEX freezing.
- Water pump off After 20 consecutive hours, disable / enable the logic that drives the water pump by itself
- In the installer setting list, select Forced operation category, and press [OK] button to move to the detail screen

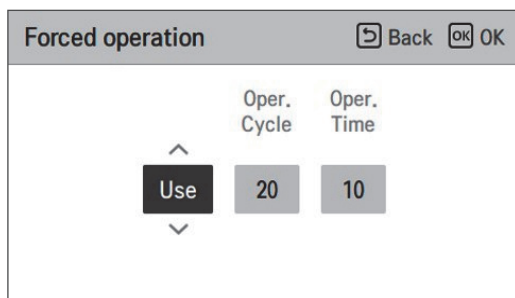
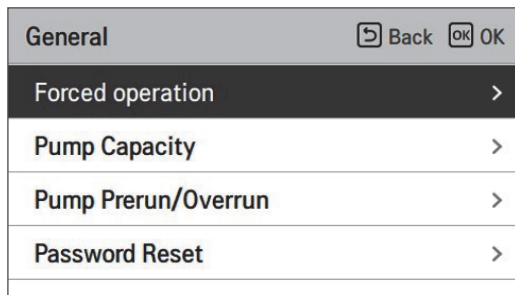

| Type        | Use (Default)                       | Not use |
|-------------|-------------------------------------|---------|
| Oper. Cycle | 20 ~ 180 hours (Default : 20 hours) | -       |
| Oper. Time  | 1 ~ 10 min (Default : 10 min)       | -       |

## Pump Prerun/Overrun

Pump Prerun operates to ensure sufficient flow before the compressor is operated. This is a function that allows heat exchange to work smoothly.

Pump Overrun is a function to prevent water pump failure and to help mechanical life.

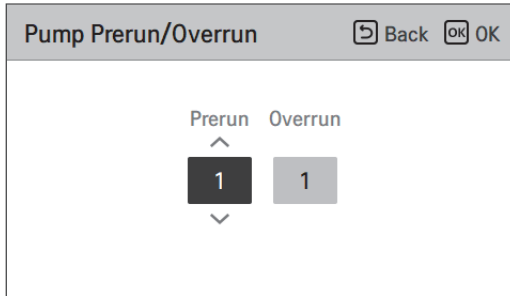
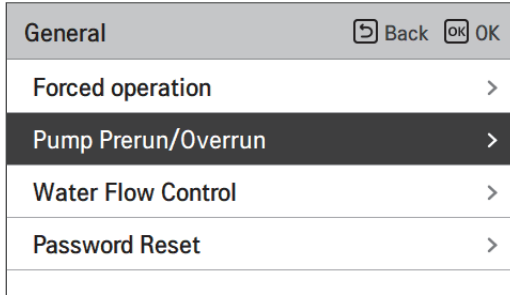

| Value   | Default | Setting Range |
|---------|---------|---------------|
| Prerun  | 1 min   | 1~10 min      |
| Overrun | 1 min   | 1~10 min      |

## Water Flow Control

This function controls the water flow by controlling the water pump. Select the way to control the water pump and set the target value

- In the installer setting list, select Configuration category, and press [OK] button to move to the detail screen.

- Optimal Flow Rate

The water pump is automatically controlled at the optimum flow rate required according to the desired temperature of the Main screen.

- Pump Capacity

It operates with the capacity set for the water pump.

- Fixed Flow Rate

The water pump is automatically controlled to maintain the set flow rate.

- Fixed  $\Delta T$

Set the target  $\Delta T$  (\* $\Delta T$  = temperature difference between inlet and outlet water temperature)

The water pump is automatically controlled to maintain the set  $\Delta T$ .

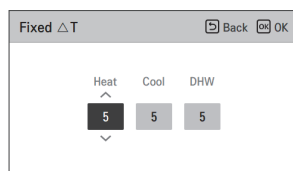
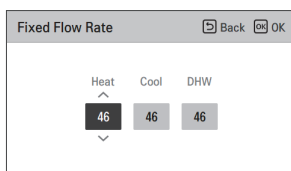
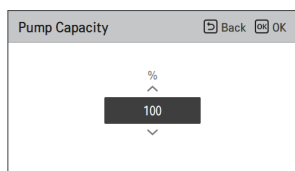
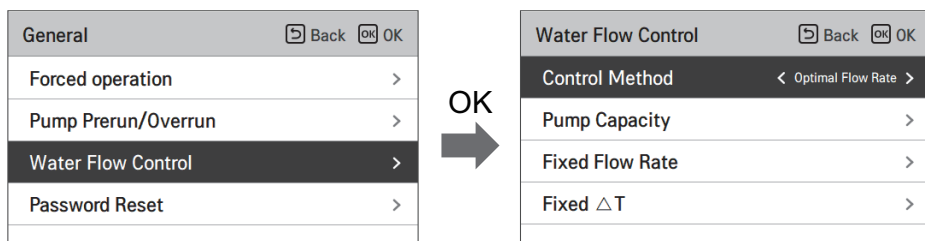

| Flow Control Method            |               |                 |                  |
|--------------------------------|---------------|-----------------|------------------|
| Optimal Flow Rate<br>(Default) | Pump Capacity | Fixed Flow Rate | Fixed $\Delta T$ |

## Energy Monitoring

This function can be set to use energy monitoring function of unit.

- Change setting values using [**<**,**>**(left/right)] button.

|   |   |
|---|---|
| General <span>Back</span> <span>OK</span> |   |
| Forced operation                          | ✓ |
| Pump Prerun/Overrun                       | > |
| Water Flow Control                        | > |
| <b>Energy Monitoring</b>                  | > |
| Password Reset                            | > |



|   |         |
|---|---------|
| Energy Monitoring <span>Back</span> <span>OK</span> |         |
| <b>Energy Monitoring</b>                            | < Use > |
| Electrical Heater Setting                           | >       |

|   |         |
|---|---------|
| Energy Monitoring <span>Back</span> <span>OK</span> |         |
| Energy Monitoring                                   | < Use > |
| <b>Electrical Heater Setting</b>                    | >       |



|   |          |
|---|----------|
| Electrical Heater Setting <span>Back</span> <span>OK</span> |          |
| Type  | Capacity |
| LG 1 Φ  | 6 kW     |

| Value                   |                 | Range                    | Default |
|-------------------------|-----------------|--------------------------|---------|
| Energy Monitoring       |                 | Use/Not Use              | Use     |
| Electric Heater Setting | Type            | LG 1Ø / LG 3Ø / EXTERNAL | LG 1Ø   |
|                         | Heater Capacity | 1 kW ~ 10 kW             | 6 kW    |

## Anti-Freezing Option 1 (For 4 Series)

This function is to select whether to use Type1 or Type2 to prevent freezing when the remote control is turned off.

- Change setting values using [,>(left/right)] button.

| General                |  | Back      | OK |
|------------------------|--|-----------|----|
| Pump Priority/Overrun  |  |           |    |
| Water Flow Control     |  | >         |    |
| Energy Monitoring      |  | >         |    |
| Anti-Freezing Option 1 |  | < Type1 > |    |
| Password Reset         |  | >         |    |

| Value          |       |
|----------------|-------|
| Type1(Default) | Type2 |

### CAUTION

If the function is set to Type 2, there is a risk of freezing.

| Function | Detection            | Case   | Operation              |
|----------|----------------------|--|------------------------|
| Type 1   | Type 2 + Inlet Temp. | Air Temp. < Certain Level<br>Inlet Temp. < Certain Level | Pump always ON         |
|          |                      | Air Temp. < Certain Level<br>Inlet Temp. > Certain Level | Pump intermittently On |
|          |                      | Air Temp. > Certain Level<br>Inlet Temp. > Certain Level | Pump always OFF        |
| Type 2   | Air Temp.            | Air Temp. < Certain Level                                | Pump intermittently On |
|          |                      | Air Temp. > Certain Level                                | Pump always OFF        |

## Password Reset

It is the function to initialize (0000) when you forgot the password set in the remote controller.

- In the installer setting list, select the password Reset setting category, and press [OK] button to move to the detail screen.
- When you press "Reset" button, a popup screen appears, and when you press "check" button, password initialization starts, and the user password is changed to 0000.

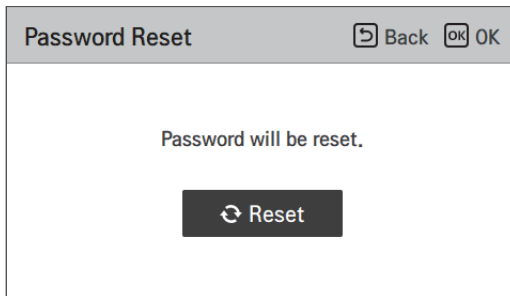
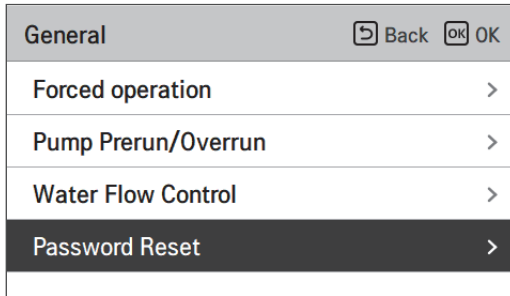

## Screed drying

This function is a unique feature of AWHP that, when AWHP is installed in a new concrete structure, controls the specific temperature floor heating out temperature for a certain period of time to cure the floor cement.

- In the installer setting list, select Screed drying category, and press [OK] button to move to the detail screen.

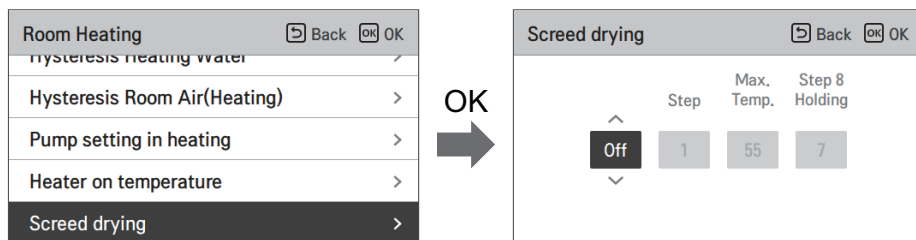

### How to display

Main Screen - Displays 'Screed drying' on the desired temperature display. The step in progress at the bottom of the display is displayed.

### Setting value

- Start-up step: 1 ~ 11
- Maximum temperature : 35 °C ~ 55 °C (Default : 55 °C)
- Step 8 Holding time : 1 days ~ 30 days (Default : 7 days)

### Function operation

- It is performed by the following procedure from the selected starting step.
- After all steps are completed, turn off the cement curing operation.

| Step                                 | 1  | 2     | 3   | 4  | 5  | 6  | 7     | 8            | 9  | 10 | 11 |
|--------------------------------------|----|-------|-----|----|----|----|-------|--------------|----|----|----|
| Leaving Water target temperature[°C] | 25 | Max.T | Off | 25 | 35 | 45 | Max.T | Max.T        | 45 | 35 | 25 |
| Duration [hours]                     | 72 | 96    | 72  | 24 | 24 | 24 | 24    | Holding time | 72 | 72 | 72 |

- ※ If the upper limit setting value of the heating LW temperature is 55 °C or lower, it is set to 55 °C forcibly.

**NOTE**

- During Screed drying operation, button input except for installer function and temperature display is restricted.
- When the power is applied again after a power outage during product operation, the product operation state before power failure is remembered and the product is automatically operated.
- Screed drying operation stops when an error occurs / When error is cleared, restart cement Screed drying. (However, if the wired remote control is reset to the error occurrence state, it is compensated in the unit of one day)
- Upon releasing after an error, Screed drying operation may take up to 1 minute of waiting time after boot up. (The Screed drying operation status is judged as 1 minute cycle.)
- During Screed drying operation, installer function Screed drying operation is selectable.
- During Screed drying operation, starting operation, low noise mode off, low noise time setting off, hot water off, solar heat off.
- During Screed drying operation, simple, sleep, on, off, weekly, holiday, heater does not execute reservation operation.

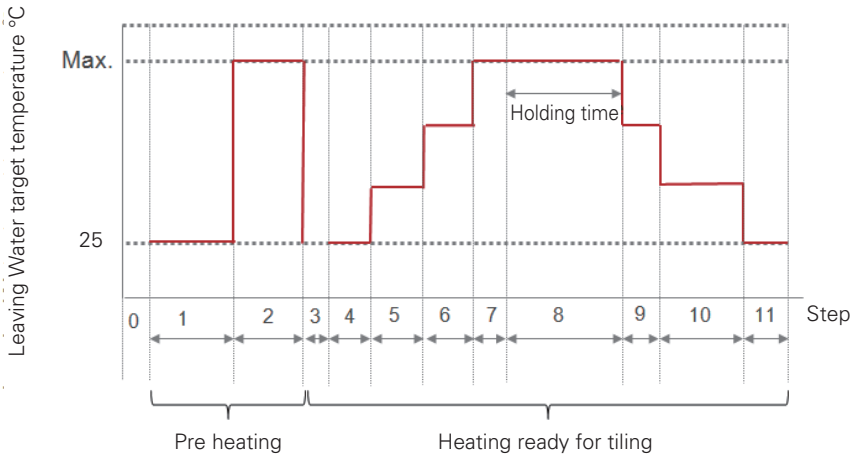

## Heater on temperature

Depending on local climatic conditions, it is necessary to change the temperature condition in which backup heater turns on / off.

- In the installer setting list, Heater on temperature category, and press [OK] button to move to the detail screen.

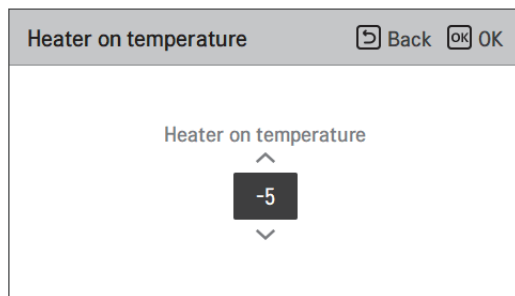
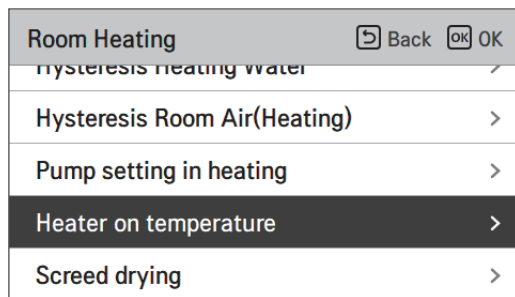

| Default (°C) | Range (°C) |
|--------------|------------|
| -5           | 18 ~ -25   |

**NOTE****• Heater on temperature**

Using Half capacity of backup heater (For Split Indoor unit 5 Series) : when DIP Switch No. 6 and 7 is set as 'ON-OFF' :

- Example : If Heater on temperature is set as '-1' and DIP switch No 6. and 7 is set as 'ON-OFF', then half capacity of electric heater will start operation when outdoor air temperature is below -1 °C and current leaving water temperature or room air temperature is much below than target leaving water temperature or target room air temperature.

Using Full capacity of backup heater : when DIP Switch No. 6 and 7 is set as 'ON-ON' :

- Example : If Heater on temperature is set as '-1' and DIP switch No 6. and 7 is set as 'ON-ON', then full capacity of electric heater will start operation when outdoor air temperature is below -1 °C and current leaving water temperature or room air temperature is much below than target leaving water temperature or target room air temperature.

## Air heating set temp.

Determine heating setting temperature range when air temperature is selected as setting temperature

- In the installer setting list, select Air heating set temp. category, and press [OK] button to move to the detail screen.

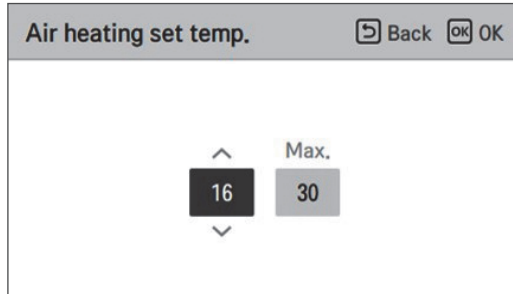
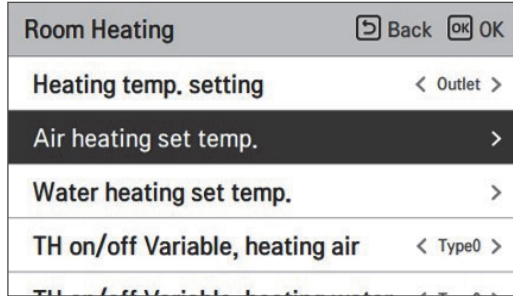

| Value | Default (°C) | Range (°C) |
|-------|--------------|------------|
| Max.  | 30           | 30~24      |
| Min.  | 16           | 22~16      |

### ! CAUTION

It is possible to control the unit based on room air temperature by using either remote air temperature sensor or wired remote controller (RS3).

- Remote room air sensor is an accessory (PQRSTA0) and sold separately.
- DIP switch setting should be set properly in order to control the unit based on room air temperature.

## Water heating set temp.

Determine heating setting temperature range when water temperature is selected as setting temperature.

- In the installer setting list, select Water heating set temp. category, and press [OK] button to move to the detail screen.

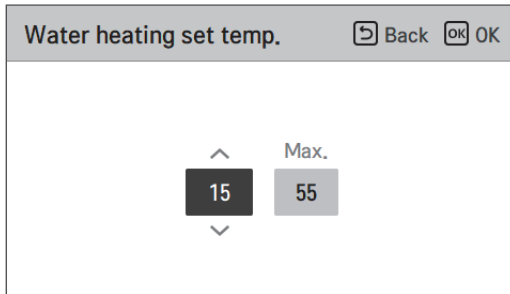
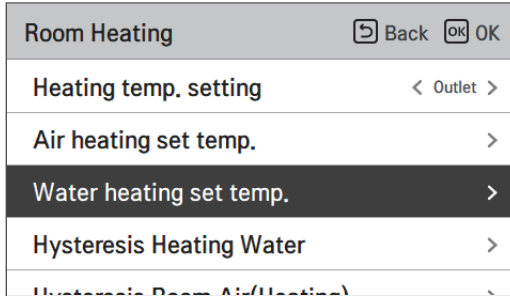

| Value | Default (°C) | Range (°C) |
|-------|--------------|------------|
| Max.  | 55           | 65 ~ 35    |
| Min.  | 15           | 34 ~ 15    |

### NOTE

- When the backup heater is not used, the minimum temperature of the water temperature can be set from 34 °C to 20 °C. (Default : 20 °C)

## Hysteresis Room Air(Heating)

It is a function to adjust the heating air temperature Thermal On / Off temperature according to the field environment in order to offer optimized heating operation.

- In the Installer setting list, and select Hysteresis Room Air(Heating) category, and press [OK] button to move to the detail screen.

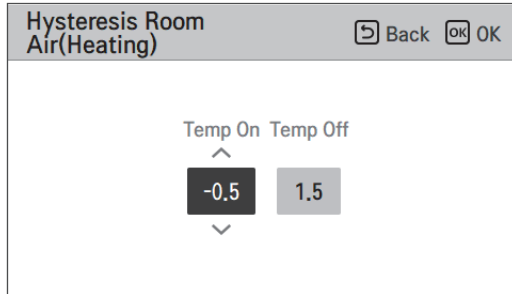
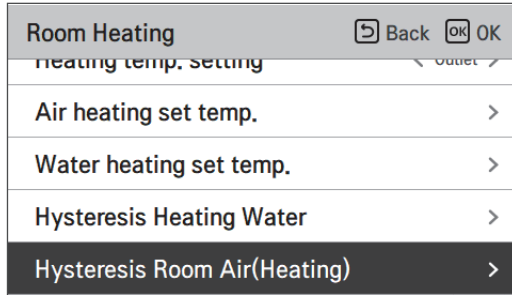

| Type     | Default (°C) | Range (°C) |
|----------|--------------|------------|
| Temp On  | -0.5         | 0 ~ -3     |
| Temp Off | 1.5          | 4 ~ 0      |

## Hysteresis Heating Water

It is a function to adjust the heating water temperature Thermal On / Off temperature according to the field environment in order to offer optimized DHW heating operation.

- In the Installer setting list, and select Hysteresis Heating Water category, and press [OK] button to move to the detail screen.

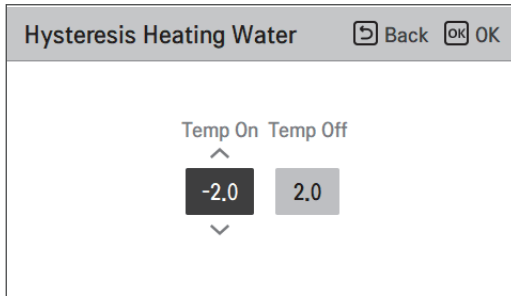
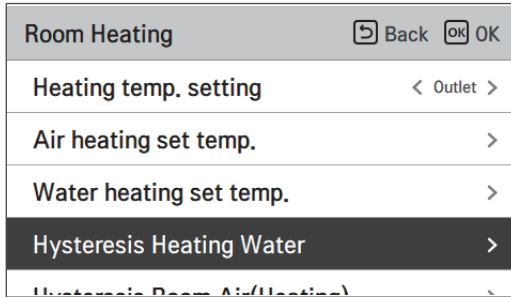

| Type     | Default (°C) | Range (°C) |
|----------|--------------|------------|
| Temp On  | -2           | 0 ~ -9     |
| Temp Off | 2            | 4 ~ 0      |

## Heating temp. setting

- At the water control in heating mode, the control reference water temperature position setting
- If the air / leaving water temperature selection setting is set to leaving water temperature
- Change setting values using [**<**,**>**(left/right)] button
- The function is not available for some products.

| Room Heating                 |   | Back       | OK |
|------------------------------|---|------------|----|
| Heating temp. setting        |   | < Outlet > |    |
| Air heating set temp.        | > |            |    |
| Water heating set temp.      | > |            |    |
| Hysteresis Heating Water     | > |            |    |
| Hysteresis Room Air(Heating) | > |            |    |

| Value            |       |
|------------------|-------|
| Outlet (Default) | Inlet |

## Pump setting in heating

- It is a function to help the water pump's mechanical life by putting the water pump's rest time
- Installer setting function to set water pump on/off interval option during thermo off condition in heating mode.
- In the installer setting list, select Pump setting in heating category, and press [OK] button to move to the detail screen.

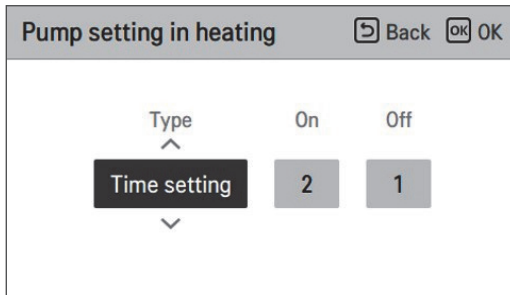
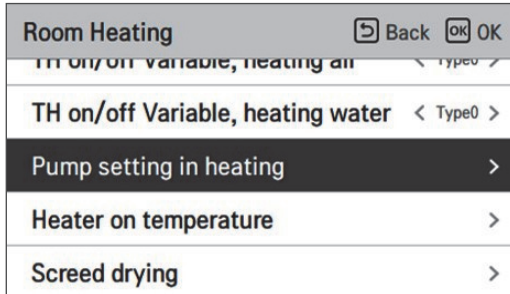

| Type                      | On                              | Off                             |
|---------------------------|---------------------------------|---------------------------------|
| Time setting<br>(Default) | 1 ~ 60 min<br>(Default : 2 min) | 1 ~ 60 min<br>(Default : 1 min) |
| Operation continue        | -                               | -                               |

## Air cooling set temp.

Determine cooling setting temperature range when air temperature is selected as setting temperature.

- In the installer setting list, select Air cooling set temp category, and press [OK] button to move to the detail screen.

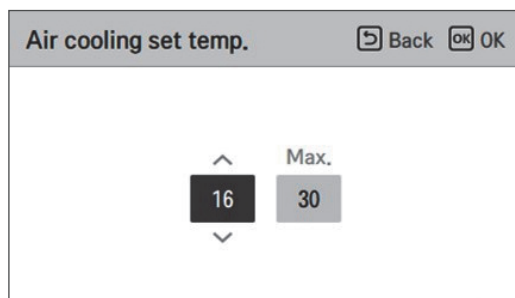
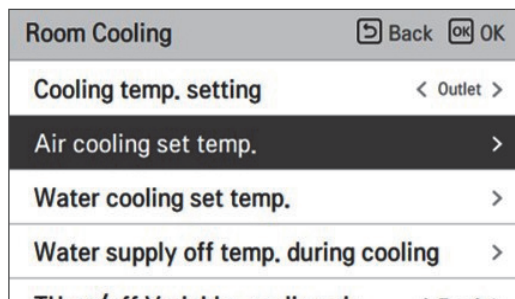

| Value | Default (°C) | Range (°C) |
|-------|--------------|------------|
| Max.  | 30           | 30~24      |
| Min.  | 18           | 22~16      |

### NOTE

It is possible to control the unit based on room air temperature by using either remote air temperature sensor or wired remote controller (RS3).

- Remote room air sensor is an accessory (PQRSTA0) and sold separately.
- DIP switch setting should be set properly in order to control the unit based on room air temperature.

## Water cooling set temp.

Determine cooling setting temperature range when water temperature is selected as setting temperature.

- In the installer setting list, select water cooling set temp category, and press [OK] button to move to the detail screen.

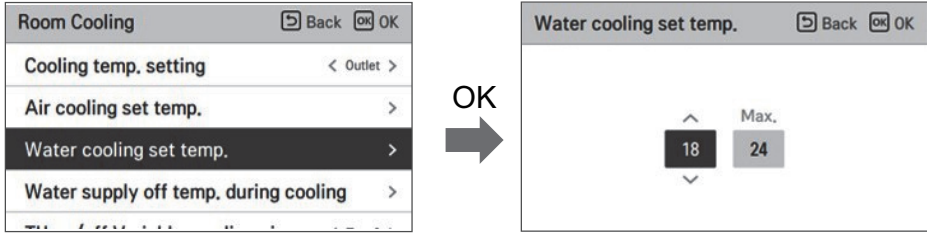

| Value | Default (°C) | Range (°C)   | Cooling temp. setting |              |
|-------|--------------|--------------|-----------------------|--------------|
| Max.  | 24           | 27~22        | All                   |              |
| Min.  | 18           | 5~20         | Outlet                | FCU use      |
|       |              | 16~20        |                       | FCU not used |
|       |              | 10~20        | Inlet                 | FCU use      |
|       | 20           | FCU not used |                       |              |

### NOTE

Water condensation on the floor

- While cooling operation, it is very important to keep leaving water temperature higher than 16 °C. Otherwise, dew condensation can be occurred on the floor.
- If floor is in humid environment, do not set leaving water temperature below 18 °C.

### NOTE

Water condensation on the radiator

- While cooling operation, cold water may not flow to the radiator. If cold water enters to the radiator, dew generation on the surface of the radiator can be occurred.

## Water supply off temp. during cooling

Determine the leaving water temperature which blocks the flow into underfloor coil in cooling mode. This function is used for preventing condensation on the floor in cooling mode

- In the installer setting list, select Water supply off temp. during cooling category, and press [OK] button to move to the detail screen.

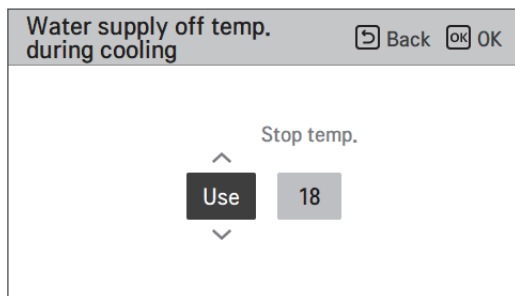
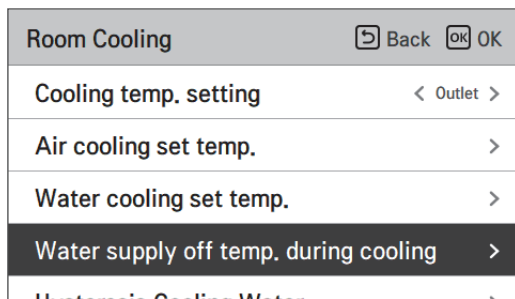

| Value   | Default | Range   |
|---------|---------|---------|
| Use     | 18      | 25 ~ 16 |
| Not use | -       | -       |

- Stop temp. : cut-off temperature. Stop temp. is valid when FCU is installed.
- FCU : determines if FCU is installed or not.
- Example : If FCU is set as 'Use', Stop temp. setting is disabled. However, if actually FCU is NOT installed in the water loop, the unit operates continuously in cooling mode until water temperature meets desired temperature. In this case, a condensed water may form on the floor caused by cold water in the underfloor coil.
- Example : If Stop temp. is set as '20' and FCU is set as 'Not use' and actually FCU is installed in the water loop, then the Stop temp. is used and the unit stops operation in cooling mode when the leaving water temperature is below 20 °C. As a result, the unit may not offer enough cooling since the cold water with desired temperature doesn't flow into the FCU.



## CAUTION

### FCU Installation

- If FCU is used, related 2way valve should be installed and connected to the unit PCB.
- If FCU is set as 'Use' whereas FCU or 2way valve is NOT installed, the unit can do abnormal operation.

## Hysteresis Room Air(Cooling)

It is a function to adjust the cooling air temperature Thermal On / Off temperature according to the field environment in order to offer optimized cooling operation.

- In the Installer setting list, and select Hysteresis Room Air(Cooling) setting category, and press [OK] button to move to the detail screen.

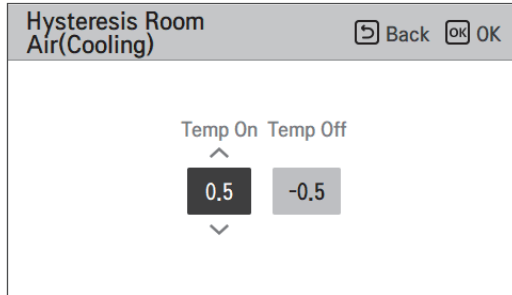
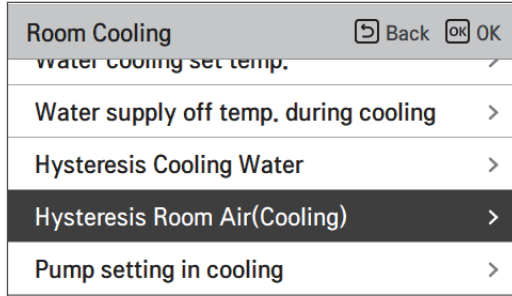

| Type     | Default (°C) | Range (°C) |
|----------|--------------|------------|
| Temp On  | 0.5          | 3 ~ 0      |
| Temp Off | -0.5         | 0 ~ -3     |

## Hysteresis Cooling Water

It is a function to adjust the cooling water temperature Thermal On / Off temperature according to the field environment in order to offer optimized cooling operation.

- In the Installer setting list, and select Hysteresis Cooling Water setting category, and press [OK] button to move to the detail screen.

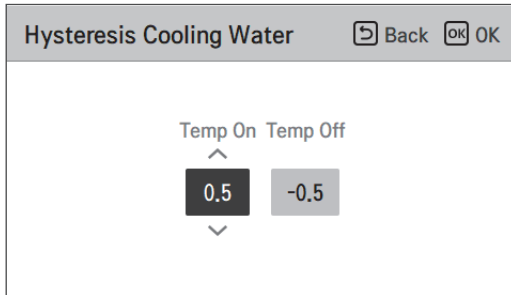
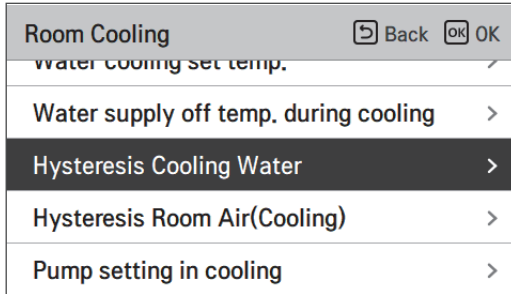

| Type     | Default (°C) | Range (°C) |
|----------|--------------|------------|
| Temp On  | 0.5          | 3 ~ 0      |
| Temp Off | -0.5         | 0 ~ -3     |

## Cooling temp. setting

- At the water control in cooling mode, the control reference water temperature position setting
- If the air / leaving water temperature selection setting is set to leaving water temperature
- Change setting values using [,<,>(left/right)] button.
- The function is not available for some products.

| Room Cooling                          |   | Back       | OK |
|---------------------------------------|---|------------|----|
| Cooling temp. setting                 |   | < Outlet > |    |
| Air cooling set temp.                 | > |            |    |
| Water cooling set temp.               | > |            |    |
| Water supply off temp. during cooling | > |            |    |
| Water in Cooling Water                | > |            |    |

| Value            |       |
|------------------|-------|
| Outlet (Default) | Inlet |

## Pump setting in cooling

- It is a function to help the water pump's mechanical life by putting the water pump's rest time
- Installer setting function to set water pump on/off interval option during thermo off condition in cooling mode.
- In the installer setting list, select Pump setting in cooling category, and press [OK] button to move to the detail screen.

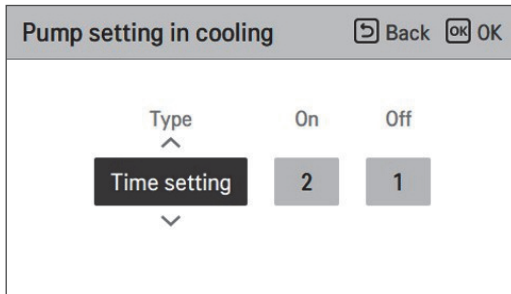
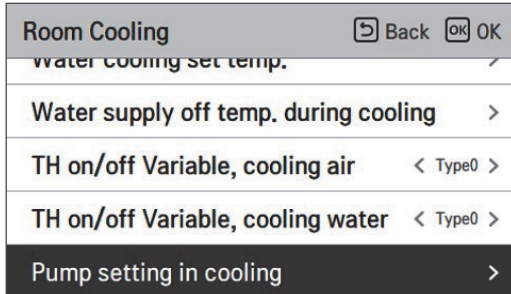

| Type                      | On                              | Off                             |
|---------------------------|---------------------------------|---------------------------------|
| Time setting<br>(Default) | 1 ~ 60 min<br>(Default : 2 min) | 1 ~ 60 min<br>(Default : 1 min) |
| Operation continue        | -                               | -                               |

## Seasonal auto temp.

It is the function to set the operation reference value in Seasonal Auto mode.

- In the installer setting list, select Seasonal auto temp category, and press [OK] button to move to the detail screen.

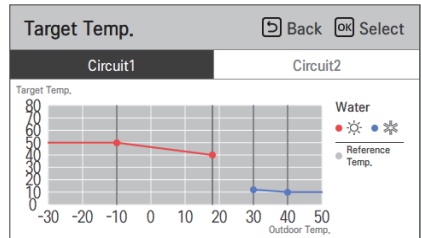
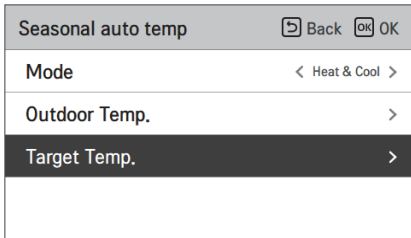
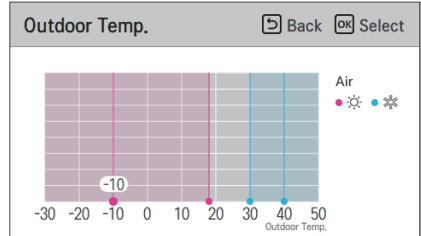
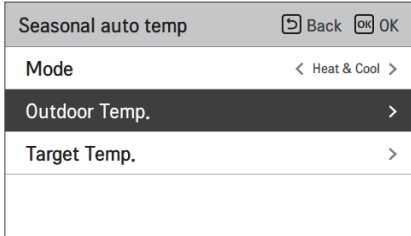
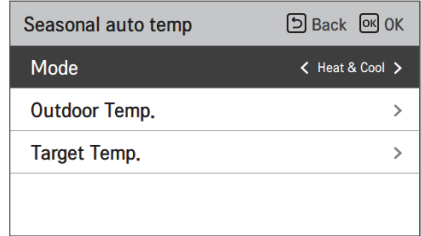
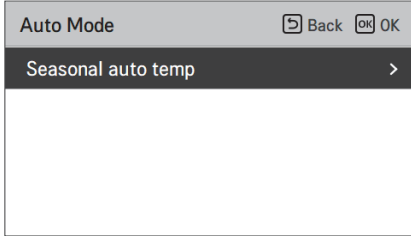

| Function             | Description                 | Range   | Default (Circuit1) | Default (Circuit2) | Boundary                         |
|----------------------|-----------------------------|---|--------------------|--------------------|----------------------------------|
| Outdoor1,Heat (Out1) | Heating lower ambient temp  | -25 ~ 35 °C   | -10 °C             |                    | Out1 ≤ Out2-1                    |
| Outdoor2,Heat (Out2) | Heating higher ambient temp |   | 18 °C              |                    | Out2 ≥ Out1 +1<br>Out2 ≤ Out3 -5 |
| Outdoor3,Cool (Out3) | Cooling lower ambient temp  | 10 ~ 46 °C  | 30 °C              |                    | Out3 ≥ Out2 +5<br>Out3 ≤ Out4 -1 |
| Outdoor4,Cool (Out4) | Cooling higher ambient temp |   | 40 °C              |                    | Out4 ≥ Out3 +1                   |
| Water1,Heat (LW1)    | Heating higher water temp   | Use heater :<br>LW STD : 15~65 °C<br>EW STD : 15~55 °C<br>Not use heater :<br>LW STD : 20~65 °C<br>EW STD : 20~55 °C  | 50 °C              | 35 °C              | LW1 ≥ LW2                        |
| Water 2,Heat (LW2)   | Heating lower water temp    |   | 40 °C              | 28 °C              | LW1 ≥ LW2                        |
| Water3,Cool (LW3)    | Cooling higher water temp   | Use FCU & 5 °C<br>IDU :<br>LW STD : 5~27 °C<br>EW STD : 10~27 °C<br>Use FCU & 6 °C<br>IDU :<br>LW STD : 6~27 °C<br>EW STD : 11~27 °C<br>Not use FCU :<br>LW STD : 16~27 °C<br>EW STD : 20~27 °C | 12 °C              | 18 °C              | LW3 ≥ LW4                        |
| Water4,Cool (LW4)    | Cooling lower water temp    |   | 10 °C              | 16 °C              | LW3 ≥ LW4                        |
| Air 1, Heat (RA1)    | Heating higher air temp     | 16 ~ 30 °C  | 21 °C              |                    | RA1 ≥ RA2                        |
| Air 2, Heat (RA2)    | Heating lower air temp      |   | 19 °C              |                    | RA1 ≥ RA2                        |
| Air 3, Cool (RA3)    | Cooling higher air temp     | 18 ~ 30 °C  | 21 °C              |                    | RA3 ≥ RA4                        |
| Air 4, Cool (RA4)    | Cooling lower air temp      |   | 19 °C              |                    | RA3 ≥ RA4                        |

- Setting range: Celsius
- Seasonal Auto Driving mode: Heating, Heating & Cooling
- \* If heating mode is selected, heating & cooling or cooling can not be selected.
- Depending on the air / outflow control selection value, the water / air related setting value is displayed on the screen.

In this mode, setting temperature will follow outdoor temperature automatically. This mode adds the cooling season function to the conventional weather dependent operation mode.

|         | Auto-Adjustable Target Temp. | Room Air Temp.(°C) | Leaving Water Temp. | Outdoor Air Temp. |           |
|---------|------------------------------|--------------------|---------------------|-------------------|-----------|
| Heating | Set point 1                  | 30~20              | 57~39               | Set point 5       | -20 ~ -10 |
|         | Set point 2                  | 19~16              | 38~20               | Set point 6       | -5 ~ 5    |
| Cooling | Set point 3                  | 30~24              | 25~17               | Set point 7       | 10 ~ 18   |
|         | Set point 4                  | 23~18              | 16~6                | Set point 8       | 22 ~ 30   |

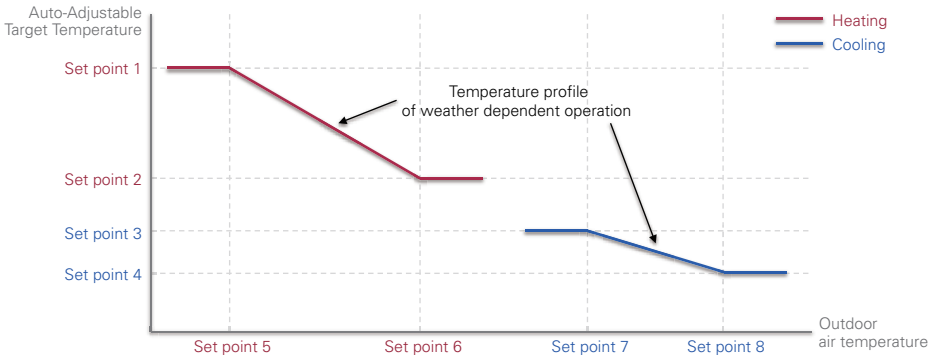

## Heater priority

- Heater priority : Determine usage of backup heater and booster heater.
- Example : If Heater priority is set as 'Main+Boost heater ON', then backup heater and booster heater are on and off according to control logic. If Heater priority is set as 'Boost heater only ON', then backup heater is never turned on and only booster heater is on and off according to control logic.
- In the installer setting list, heater priority category, and press [OK] button to move to the detail screen.

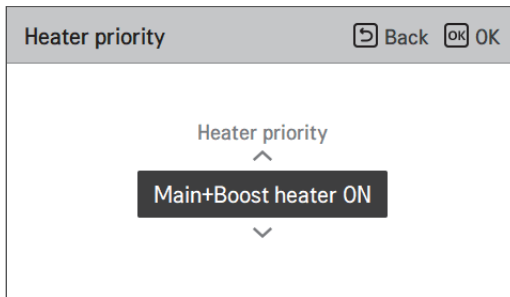
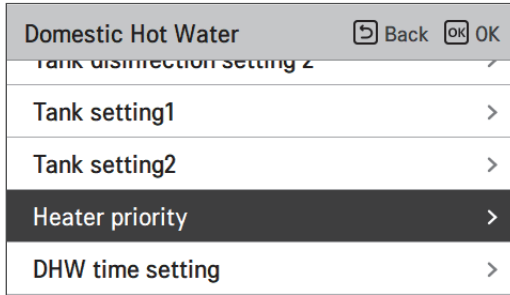

| Value                |                                   |
|----------------------|-----------------------------------|
| Boost heater only ON | Main+Boost heater ON<br>(Default) |

## DHW set temp.

Determine heating setting temperature range when DHW temperature is selected as setting temperature

- In the installer setting list, select DHW set temp. category, and press [OK] button to move to the detail screen.

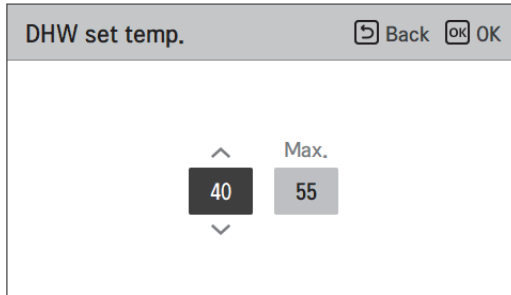
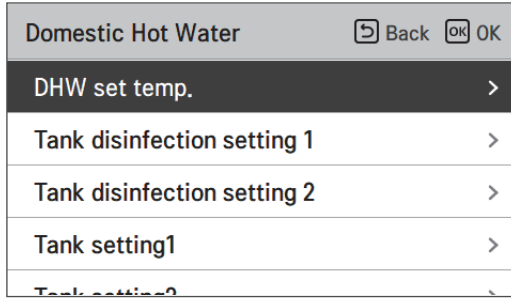

| Value | Default (°C) | Range (°C) |
|-------|--------------|------------|
| Max.  | 55           | 80 ~ 50    |
| Min.  | 40           | 40 ~ 30    |

## Tank disinfection setting 1, 2

- Disinfection operation is special DHW tank operation mode to kill and to prevent growth of legionella inside the tank.
  - Disinfection active : Selecting enable or disable of disinfection operation.
  - Start date : Determining the date when the disinfection mode is running.
  - Start time : Determining the time when the disinfection mode is running.
  - Max temp. : Target temperature of disinfection mode.
  - Duration time : Duration of disinfection mode.

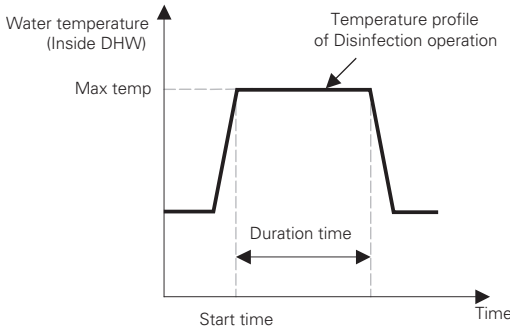

|                                    |      |    |
|------------------------------------|------|----|
| Domestic Hot Water                 | Back | OK |
| DHW set temp.                      | >    |    |
| <b>Tank disinfection setting 1</b> | >    |    |
| Tank disinfection setting 2        | >    |    |
| Tank setting1                      | >    |    |
| Tank setting2                      | >    |    |



|                             |            |            |
|-----------------------------|------------|------------|
| Tank disinfection setting 1 | Back       | OK         |
| Disinfection active         | Start date | Start time |
| Not use                     | Fri.       | 23         |

|                                    |      |    |
|------------------------------------|------|----|
| Domestic Hot Water                 | Back | OK |
| DHW set temp.                      | >    |    |
| Tank disinfection setting 1        | >    |    |
| <b>Tank disinfection setting 2</b> | >    |    |
| Tank setting1                      | >    |    |
| Tank setting2                      | >    |    |



|                             |               |                 |
|-----------------------------|---------------|-----------------|
| Tank disinfection setting 2 | Back          | OK              |
| Max temp.                   | Duration time | Forced end time |
| 70                          | 10            | 1               |

### NOTE

DHW heating should be enable

- If Disinfection active is set as ' Not use', that is 'disable disinfection mode', Start date and Start time is not used.

## Tank setting 1

- In the installer setting list, select tank setting 1 category, and press [OK] button to move to the detail screen.

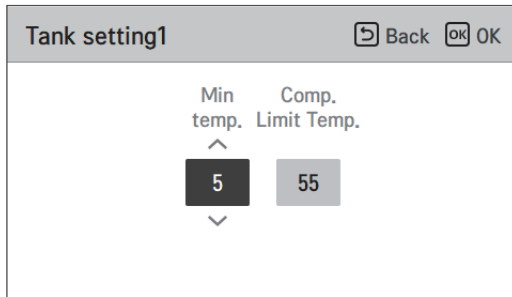
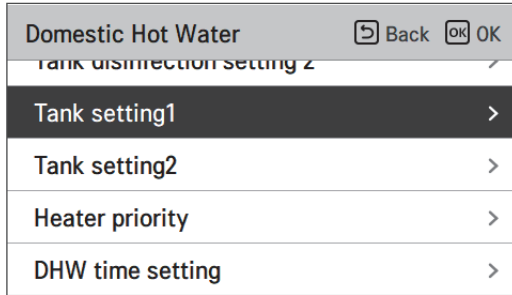

| Value             | Default (°C) | Range (°C) |
|-------------------|--------------|------------|
| Min. temp.        | 5            | 30 ~ 1     |
| Comp. Limit Temp. | 55           | 58 ~ 40    |

## Tank setting 2

- In the installer setting list, select tank setting 2 category, and press [OK] button to move to the detail screen.

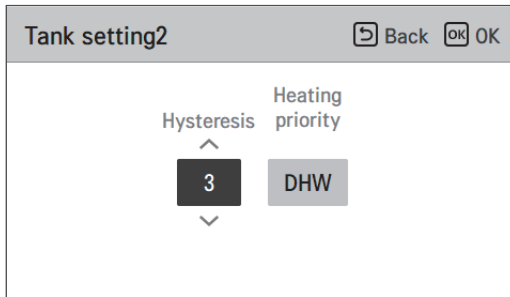
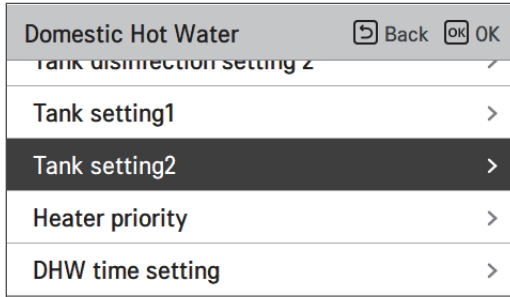

| Value            | Range               |
|------------------|---------------------|
| Hysteresis       | 4~2                 |
| Heating priority | Floor heating / DHW |

### • Tank setting 1, 2

Descriptions for each parameters are as following.

- Min temp. : temperature gap from Max outdoor temp.
- Max outdoor temp. : maximum temperature generated by AWHP compressor cycle.
- Example : If Min temp. is set as '5' and Max outdoor temp. is set as '48', then Session A (see the graph) will be started when the water tank temperature is below 43 °C.... If temperature is above 48 °C..., then Session B will be started.
- Hysteresis : temperature gap from target DHW temperature. This value is required to prevent frequent On and Off of booster heater.
- Heating priority : Determining heating demand priority between DHW tank heating and under floor heating.
- Example : If user's target temperature is set as '70' and Hysteresis is set as '3', then the booster heater will be turned off when the water temperature is above 73 °C. The booster heater will be turned on when the water temperature is below 70 °C.
- Example : If Heating priority is set as 'DHW', that means heating priority is on DHW heating, DHW is heated by AWHP compressor cycle and booster heater. In this case the under floor can not be heated while DHW heating. On the other hand, if the Heating priority is set as 'Floor heating', that means heating priority is on under floor heating, DHW tank is ONLY heated by booster heater. In this case the under floor heating is not stopped while DHW is heated.

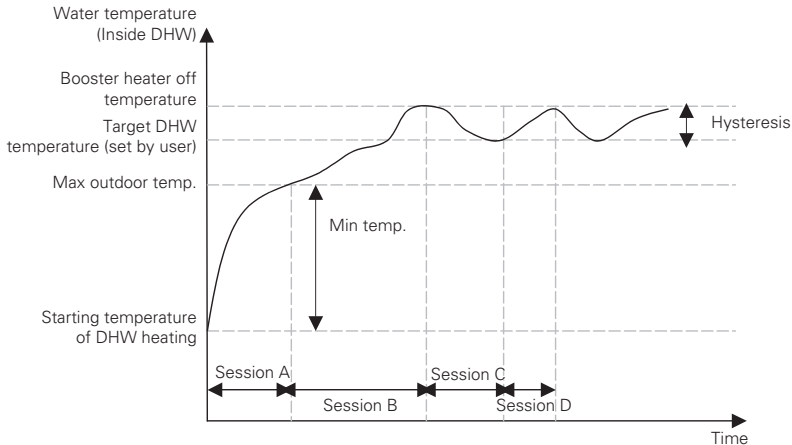

Session A : Heating by AWHP compressor cycle and booster heater

Session B : Heating by booster heater

Session C : No heating (booster heater is Off)

Session D : Heating by booster heater

### NOTE

DHW heating does not operate when it is disabled.

## DHW time setting

Determine following time duration : operation time of DHW tank heating, stop time of DHW tank heating, and delay time of DHW tank heater operating.

- Active time : This time duration defines how long time DHW tank heating can be continued.
- Stop time : This time duration defines how long time DHW tank heating can be stopped. It is also regarded as time gap between DHW tank heating cycle.
- Boost heater delay time : This time duration defines how long time DHW tank heater will not be turned on in DHW heating operation.
- Example of timing chart :

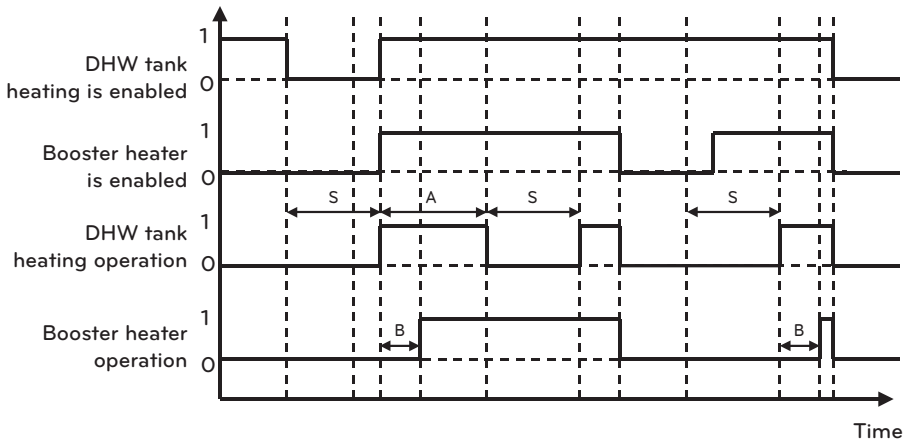

- \* 1=active / 0=not active
- \* A = Active time
- \* S = Stop time
- \* B = Boost heater delay time

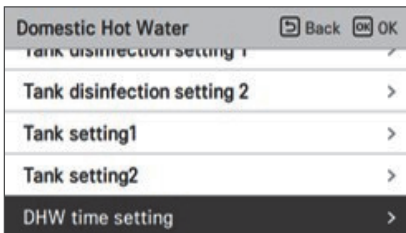

| Value       | Default | Range     |
|-------------|---------|-----------|
| Active time | 30 min  | 5~95 min  |
| Stop time   | 30 min  | 0~600 min |

## Recirculation time

- It is function to set recirculation water pump on/off interval option
- In the installer setting list, select Recirculation time category, and press [OK] button to move to the detail screen.

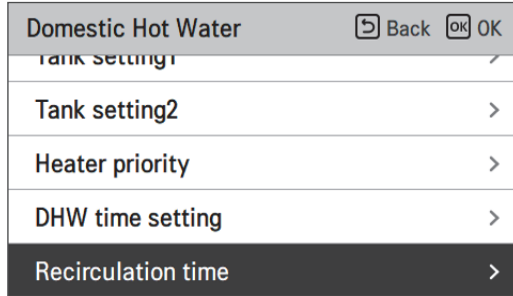

| Value             | Default | Range         |
|-------------------|---------|---------------|
| DHW recirculation | Not use | Use / Not use |
| ON Time           | 10 min  | 1 ~ 60 min    |
| OFF Time          | 20 min  | 1 ~ 60 min    |

## Solar Thermal System

It is function to set operation reference value in Solar Thermal System.

In the installer setting list, select Solar thermal system category, and press [OK] button to move to the detail screen.

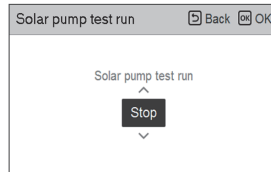
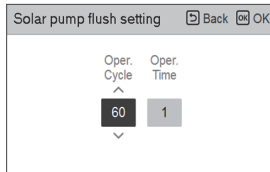
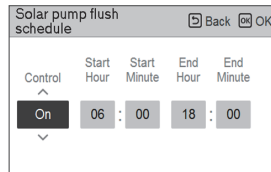
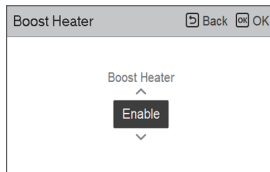
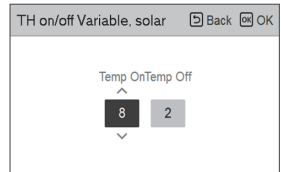
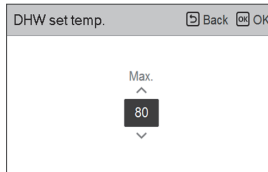
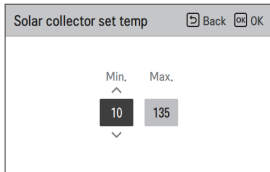
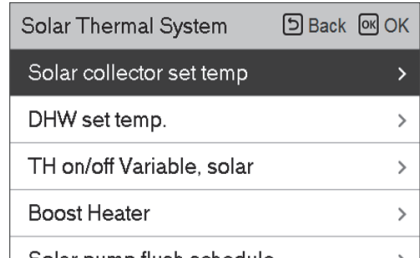
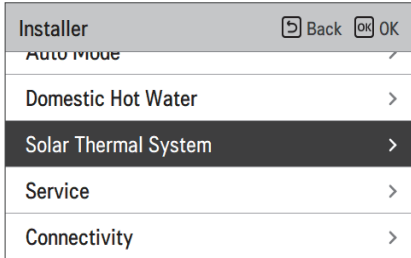

### NOTE

To use this function, switch No.2 of option switch 2 must be turned ON and No.3 of option switch 2 must be turned OFF.

**Descriptions for each parameters are as following.**

- Solar collector set temp
  - Min temp : It is the minimum solar collector temperature at which the solar thermal system can operate.
  - Max temp : It is the maximum solar collector temperature at which the solar thermal system can operate.
- TH on/off Variable, solar
  - Temp on : It is the temperature difference between the current solar thermal temperature and DHW tank temperature at which the solar thermal system operates.
  - Temp off : It is the temperature difference between the current solar thermal temperature and DHW tank temperature at which the solar thermal system stops.
  - Example : If the current solar collector temperature is 80 °C and Temp on is set to 8 °C, the solar thermal system operates when the DHW tank temperature is less than 72 °C. In the same case, if Temp off is set to 2 °C, Solar Thermal System stops when DHW temperature is 78 °C.
- DHW Set Temp
  - Max : It is maximum temperature of DHW that can be reached by solar thermal system.
- Boost Heater
  - Enable : Booster heater can be used when operating the Solar Thermal system.
  - Disable : Booster heater cannot be used when operating the Solar Thermal system.
- Solar pump flush schedule
  - It is the function to circulate the solar water pump intermittently for solar collector temperature detection when the solar water pump does not operate for a long time. Turn on to use this function.
- Solar Pump flush setting
  - Oper.Cycle : When using the solar pump flush function, the solar water pump operates at the set time.
  - Oper.Time : When using the solar pump flush function, the solar water pump operates during the set time.

| Function                  | Value                    | Range            | Default |
|---------------------------|--------------------------|------------------|---------|
| Solar collector set temp  | Min                      | 5 °C ~ 50 °C     | 10 °C   |
|                           | Max                      | 60 °C ~ 200 °C   | 95 °C   |
| DHW set temp              | Max                      | 20 °C ~ 90 °C    | 80 °C   |
| TH on/off Variable, solar | Temp On                  | 3 °C ~ 40 °C     | 8 °C    |
|                           | Temp Off                 | 1 °C ~ 20 °C     | 2 °C    |
| Boost Heater              | Boost Heater             | Enable/Disable   | Enable  |
| Solar pump flush schedule | On/OFF                   | On/Off           | On      |
|                           | Start Hour, Start Minute | 00:00 ~ 24:00    | 6:00    |
|                           | End Hour, End Minute     | 00:00 ~ 24:00    | 18:00   |
| Solar pump test run       | Pump test Run            | Start/Stop       | Stop    |
| Solar pump flush setting  | Oper.Cycle               | 30 min ~ 120 min | 60 min  |
|                           | Oper.Time                | 1 min ~ 10 min   | 1 min   |

## Pump test run

The pump test run is to test run by operating the water pump for 1 hour.

This function can be used for air purging through air vents and checking flow rate and others.

- In the installer setting list, Pump Test run category, and press [OK] button to move to the detail screen.

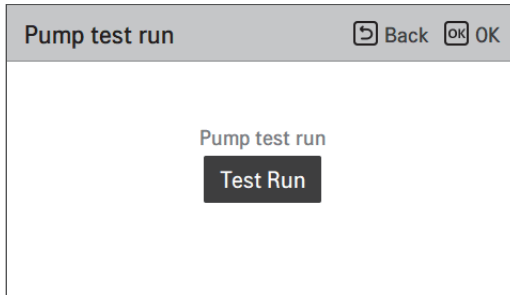
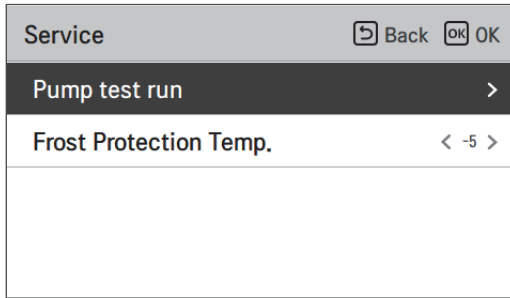

## Frost Protection Temp.

This function prevents the unit from freezing. This function sets the freeze protection temperature according to the concentration injected after injecting antifreeze.

- Change setting values using [ $\leftarrow$ ,  $\rightarrow$  (left/right)] button.
- The function is not available for some products.

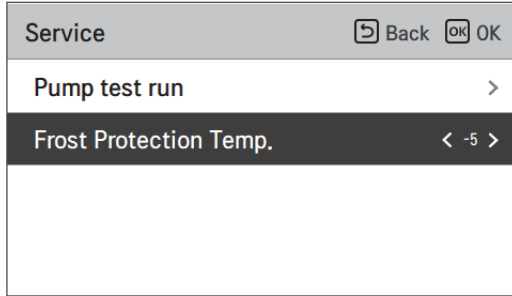

| Range (°C) | Default (°C) |
|------------|--------------|
| -25 ~ -5   | -5           |

### NOTE

To use this function, the antifreeze short pin (CN\_ANTI\_SW) must be open and switch No.8 in Option SW 1 must be on.

### Antifreeze short pin

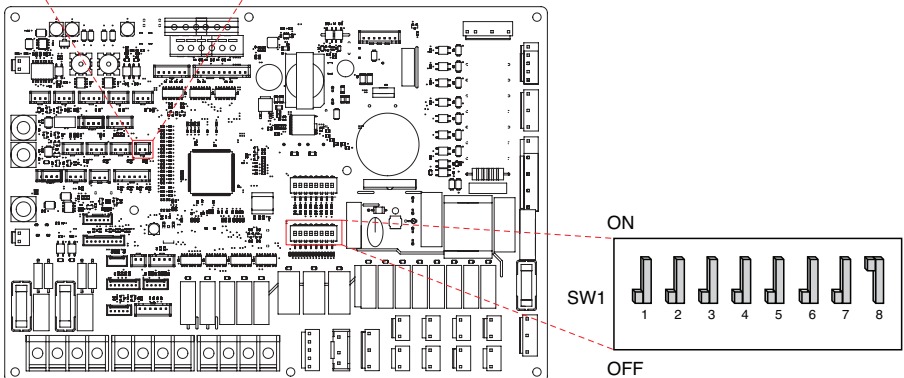
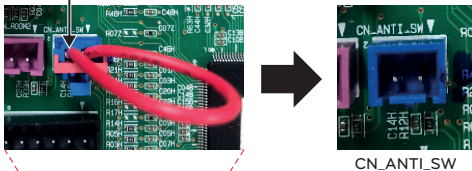

## Dry Contact Mode

Dry contact function is the function that can be used only when the dry contact devices is separately purchased and installed.

- Change setting values using [<,>(left/right)] button.

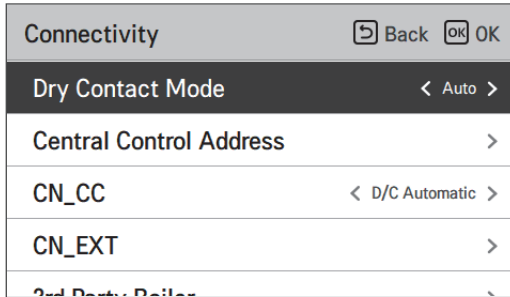

| Value          | Description                                       |
|----------------|---|
| Auto (Default) | Automatically operation ON with release hard lock |
| Manual         | Keep operation OFF with hard lock                 |

### NOTE

For dry contact mode related detail functions, refer to the individual dry contact manual.

What is dry contact?

It means the contact point signal input when the hotel card key, human body detection sensor, etc. are interfacing with the unit.

Added system functionality by using external inputs (dry contacts and wet contacts).

## Central Control Address

When connecting the central control, set the central control address of the unit.

- In the installer setting list, select Central Control Address category, and press [OK] button to move to the detail screen.

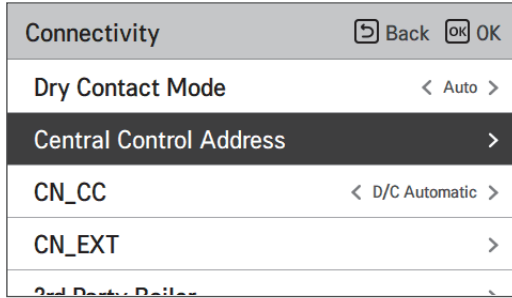

### NOTE

Enter address code as hexadecimal value  
 Front: Central Control Gr. No.  
 Back side: Central control indoor the number

### NOTE

This function is not available for monobloc

## CN\_CC

It is the function to set the usage of the unit's CN\_CC port.

- Change setting values using [<,>(left/right)] button

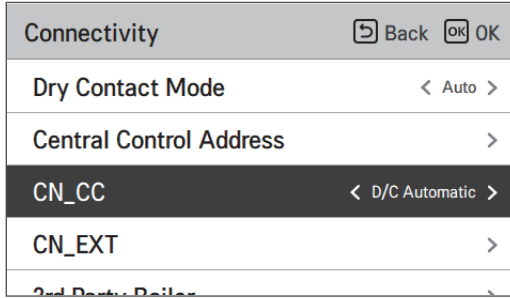

| Value                   | Description  |
|-------------------------|--|
| D/C Automatic (Default) | When power is applied to the product, the unit when the contact point is on in Dry Contact installed state recognizes Dry Contact installation |
| D/C Not Installed       | Do not use (install) Dry Contact   |
| D/C Installed           | Use (install) Dry Contact  |

### NOTE

CN\_CC is the device connected to the unit to recognize and control the external contact point.

## LG Therma V Configuration

This function can be set to save the environment settings of the product for use in LG Therma V Configurator through SD Card.

- In the Installer setting list, and select LG Therma V Configuration setting category, and press [OK] button to move to the detail screen.

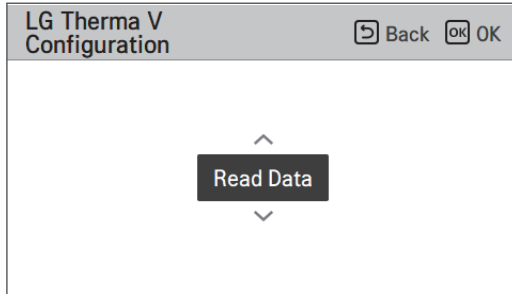
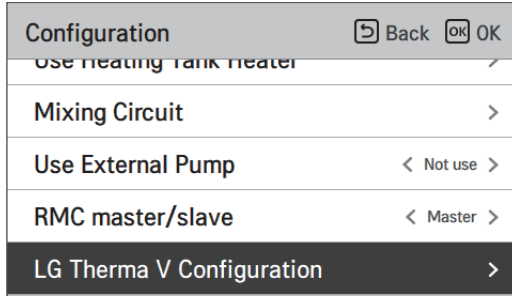

| Value     |           |
|-----------|-----------|
| Read Data | Save Data |

## Pump frequency setting (RPM)

It is a function to enable installer to control pump RPM of BLDC pump application model.

- In the installer setting list, select Pump frequency setting(RPM) category, and press [OK] button to move to the detail screen.
- The function is not available for some products.

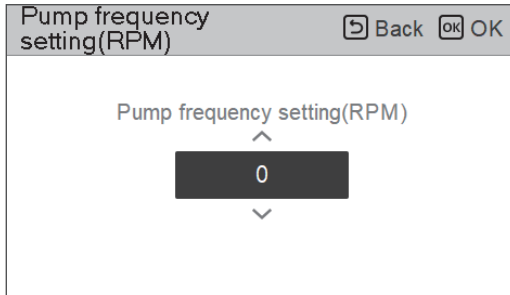
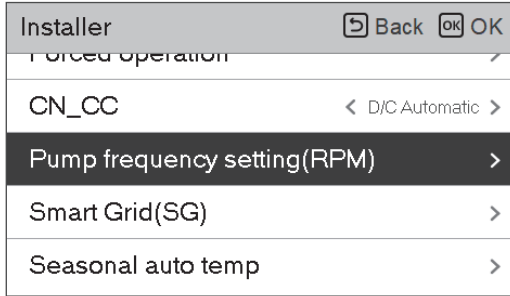

| Value | Description                         |
|-------|-------------------------------------|
| 3 500 | 500~3 700 : RPM<br>Change unit : 10 |

## Smart Grid(SG)

It is the function to enable / disable the SG Ready function and to set the reference value at SG2 step.

- In the installer setting list, select Smart Grid(SG) category, and press [OK] button to move to the detail screen.

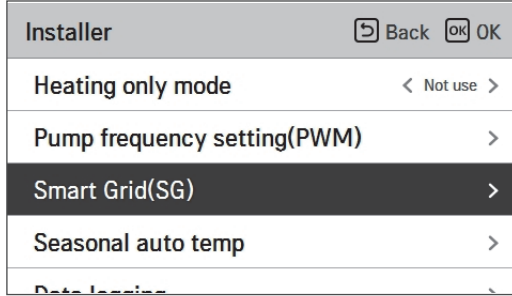

| Value             | Mode   |
|-------------------|--------|
| Not use (Default) | -      |
| Use               | Step 0 |
|                   | Step 1 |
|                   | Step 2 |

## Power Supply Blockage (Smart Grid)

The heat pump operated automatically by the power supply status signals from power supply companies. This function can respond to European countries' special tariff for heat pump using on a smart grid.

4 modes  
depending on  
power supply status

### Power Supply Status



### Operating Mode

#### 0:0 [Normal Operation]

The heat pump works at maximum efficiency.

#### 1:0 [Switch-off command, Utility lock]

Deactivates the heat pump to avoid peak load. The maximum blocking time depends on the system's thermal storage capacity, but amounts to at least 2 hours 3 times a day. (No frost protection)

#### 0:1 [Switch-on recommendation]

The switch-on recommendation and set value storage tank temperature is increased, depending on the parameter "Mode SG"

Mode SG : set temperature +  $\alpha$   
depending on the below parameter

Step 0 (DHW +5 °C)

Step 1 (H/P+2 °C, DHW +5 °C)

Step 2 (H/P+5 °C, DHW +7 °C)

#### 1:1 [Switch-on command]

The command activates the compressor. Optionally, electrical booster heaters can be activated to utilize electricity surpluses.

## Energy state

This function is to control the product according to the energy state. When the charged state of ESS is transmitted, it changes the target temperature of heating, cooling and DHW by setting value according to energy state.

Select either Signal Mode or Modbus Mode according to the connection type between the product and the ESS.

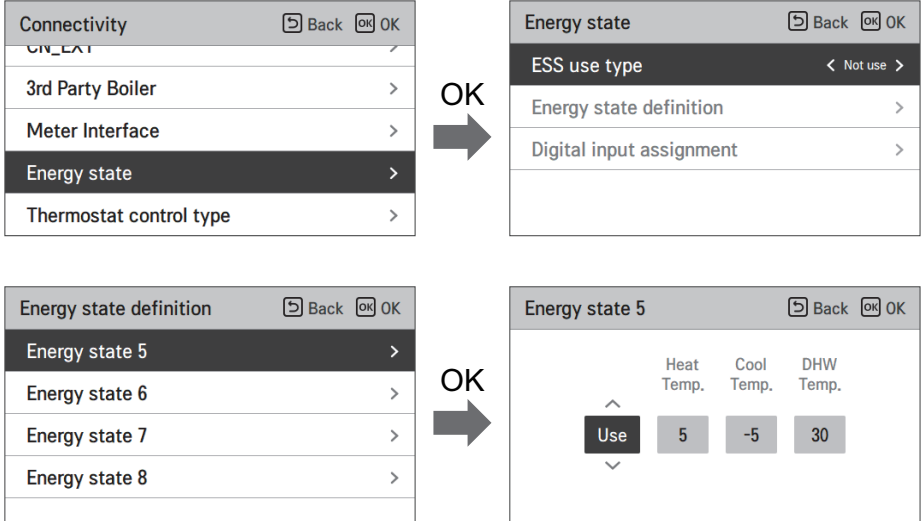

When Signal Mode of EES use type is selected, press the Digital Input Assignment button to set the energy state according to the input signal.

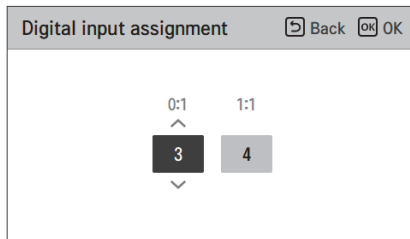

| Value | Input Signal |        | Output state |         |
|-------|--------------|--------|--------------|---------|
|       | TB_SG1       | TB_SG2 | Default      | Range   |
| X     | 0            | 0      | ES2          | fixed   |
| X     | 1            | 0      | ES1          | fixed   |
| 0:1   | 0            | 1      | ES3          | ES3-ES8 |
| 1:1   | 1            | 1      | ES4          |         |

## Thermostat control type

It is a function to enable installer to control Water Pump Options using water flow sensor.

- In the Installer setting list, and select Connectivity category, and press [OK] button to move to the detail screen.

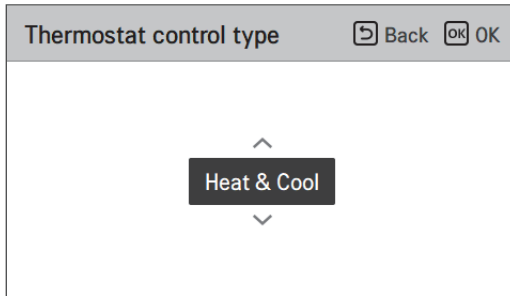
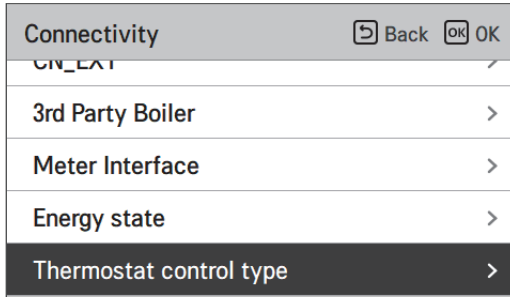

| Type                  |                   |
|-----------------------|-------------------|
| Heat & Cool (Default) | Heat & Cool / DHW |

## Pump operation time

It is a function to show the water pump's operation time for check mechanical life.

- In the Installer setting list, and select Information category, and press [OK] button to move to the detail screen.

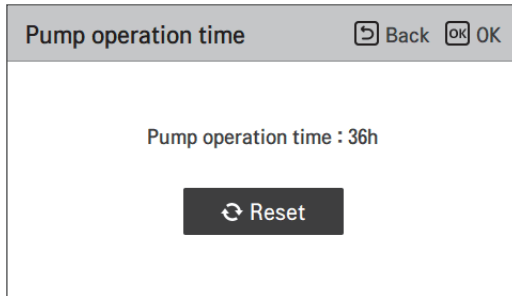
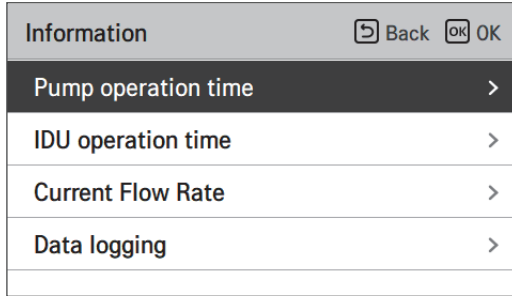

## IDU operation time

It is a function to show the Indoor Unit's operation time for check mechanical life.

- In the Installer setting list, and select Information category, and press [OK] button to move to the detail screen.

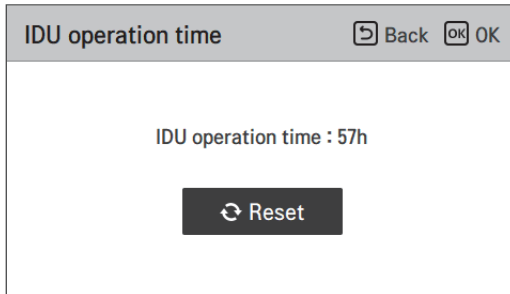
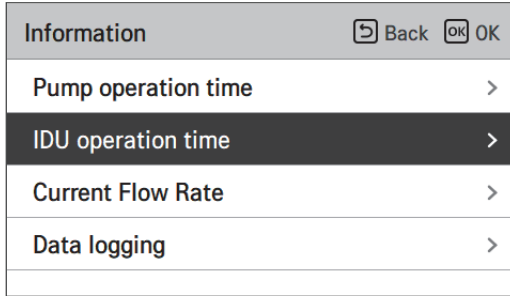

## Modbus Address

It is function to set the address of the Modbus device that is externally linked to the product. Modbus address setting function is available from indoor unit.

- In the installer setting list, select Modbus Address , and press [OK] button to move to the detail screen.

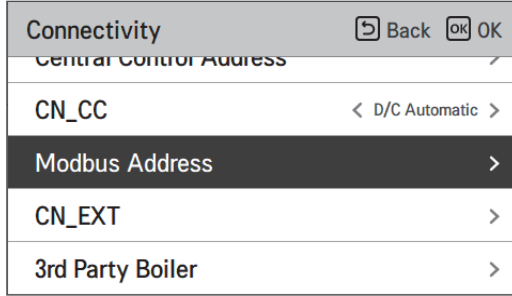

### NOTE

To use this function, switch No.1 of option switch 1 must be turned ON.

## Modbus gateway memory map

Baud Rate : 9 600 bps Stop Bit : 1 stop bit Parity : None Parity

### Coil Register (0x01)

| Register | Description                      | Value explanation                         |
|----------|----------------------------------|---|
| 00001    | Enable/Disable (Heating/Cooling) | 0 : Operation OFF / 1 : Operation ON      |
| 00002    | Enable/Disable (DHW)             | 0 : Operation OFF / 1 : Operation ON      |
| 00003    | Silent Mode Set                  | 0 : Silent mode OFF / 1 : Silent mode ON  |
| 00004    | Trigger Disinfection operation   | 0 : Keep status / 1 : Operation start     |
| 00005    | Emergency Stop                   | 0 : Normal operation / 1 : Emergency stop |
| 00006    | Trigger Emergency Operation      | 0 : Keep status / 1 : Operation Start     |

### Discrete Register (0x02)

| Register | Description  | Value explanation                                   |
|----------|--|---|
| 10001    | Water flow status  | 0 : Flow rate ok / 1 : Flow rate too low            |
| 10002    | Water Pump status  | 0 : Water Pump OFF / 1 : Water Pump ON              |
| 10003    | Ext. Water Pump status                                   | 0 : Water Pump OFF / 1 : Water Pump ON              |
| 10004    | Compressor status  | 0 : Compressor OFF / 1 : Compressor ON              |
| 10005    | Defrosting status  | 0 : Defrost OFF / 1 : Defrost ON                    |
| 10006    | DHW heating status<br>(DHW Thermal On/Off)               | 0 : DHW inactive / 1 : DHW active                   |
| 10007    | DHW Tank disinfection status                             | 0 : Disinfection inactive / 1 : Disinfection active |
| 10008    | Silent mode status                                       | 0 : Silent mode inactive / 1 : Silent mode active   |
| 10009    | Cooling status   | 0 : No cooling / 1 : Cooling operation              |
| 10010    | Solar pump status  | 0 : Solar pump OFF / 1 : Solar pump ON              |
| 10011    | Backup heater (Step 1) status                            | 0 : OFF / 1 : ON                                    |
| 10012    | Backup heater (Step 2) status                            | 0 : OFF / 1 : ON                                    |
| 10013    | DHW boost heater status                                  | 0 : OFF / 1 : ON                                    |
| 10014    | Error status   | 0 : no error / 1 : error state                      |
| 10015    | Emergency Operation Available<br>(Space heating/cooling) | 0 : Unavailable / 1 : Available                     |
| 10016    | Emergency Operation Available<br>(DHW)                   | 0 : Unavailable / 1 : Available                     |
| 10017    | Mix pump status  | 0 : Mix pump OFF / 1 : Mix pump ON                  |

## Holding Register (0x03)

| Register | Description                | Value explanation   |
|----------|----------------------------|---|
| 30001    | Error Code                 | Error Code  |
| 30002    | ODU operation Cycle        | 0 : Standby(OFF) / 1 : Cooling / 2 : Heating  |
| 30003    | Water inlet temp.          | [0.1 °C ×10]  |
| 30004    | Water outlet temp.         | [0.1 °C ×10]  |
| 30005    | Backup heater outlet temp. | [0.1 °C ×10]  |
| 30006    | DHW tank water temp.       | [0.1 °C ×10]  |
| 30007    | Solar collector temp.      | [0.1 °C ×10]  |
| 30008    | Room air temp. (Circuit 1) | [0.1 °C ×10]  |
| 30009    | Current Flow rate          | [0.1 LPM ×10]   |
| 30010    | Flow temp. (Circuit 2)     | [0.1 °C ×10]  |
| 30011    | Room air temp. (Circuit 2) | [0.1 °C ×10]  |
| 30012    | Energy State input         | 0 : Energy state 0; 1: Energy state 1....   |
| 30013    | Outdoor Air temp.          | [0.1 °C ×10]  |
| 39998    | Produc Group               | 0x8X (0x80, 0x83, 0x88, 0x89)   |
| 39999    | Product Info.              | Split : 0 / Monobloc : 3 / High Temp. : 4 /<br>Medium Temp. : 5 / System Boiler : 6 |

Input Register (0x04)

| Register | Description                                | Value explanation  |
|----------|--|--|
| 40001    | Operation Mode                             | 0 : Cooling / 4 : Heating / 3 : Auto   |
| 40002    | Control method (Circuit 1/2)               | 0 : Water outlet temp. control<br>1 : Water inlet temp. control<br>2 : Room air control  |
| 40003    | Target temp (Heating/Cooling) Circuit 1    | [0.1 °C ×10]   |
| 40004    | Room Air Temp. Circuit 1                   | [0.1 °C ×10]   |
| 40005    | Shift value(Target) in auto mode Circuit 1 | 1K   |
| 40006    | Target temp (Heating/Cooling) Circuit 2    | [0.1 °C ×10]   |
| 40007    | Room Air Temp. Circuit 2                   | [0.1 °C ×10]   |
| 40008    | Shift value(Target) in auto mode Circuit 2 | 1K   |
| 40009    | DHW Target temp.                           | [0.1 °C ×10]   |
| 40010    | Energy state input                         | 0 : Not Use<br>1 : Forced off (equal to TB_SG1=close / TB_SG2=open)<br>2 : Normal operation (equal to TB_SG1=open / TB_SG2=open)<br>3 : On-recommendation (equal to TB_SG1=open / TB_SG2=close)<br>4 : On-command (equal to TB_SG1=close / TB_SG2=close)<br>5 : On-command step 2 ( ++ Energy Consumption compared to Normal)<br>6 : On-recommendation Step 1 ( + Energy Consumption compared to Normal)<br>7 : Energy Saving mode ( - Energy Consumption compared to Normal)<br>8 : Super Energy saving mode ( – Energy Consumption compared to Normal) |

## CN\_EXT

It is a function to control external input and output according to DI type set by customer using CN-EXT Port.

- In the installer setting list, select CN-EXT Port category, and press [OK] button to move to the detail screen.

| Connectivity            |                   | Back | OK |
|-------------------------|-------------------|------|----|
| Dry Contact Mode        | < Auto >          |      |    |
| Central Control Address | >                 |      |    |
| CN_CC                   | < D/C Automatic > |      |    |
| CN_EXT                  | >                 |      |    |
| 2nd Party Boiler        | >                 |      |    |



| CN_EXT             |                       | Back | OK |
|--------------------|-----------------------|------|----|
| Not use            | Simple Operation      |      |    |
| Simple Dry Contact | Single emergency stop |      |    |

| Value                |                  |                    |                       |
|----------------------|------------------|--------------------|-----------------------|
| Not use<br>(Default) | Simple Operation | Simple Dry Contact | Single emergency stop |

### 3rd Party Boiler

This function is to configure the 3rd party boiler to be controlled.

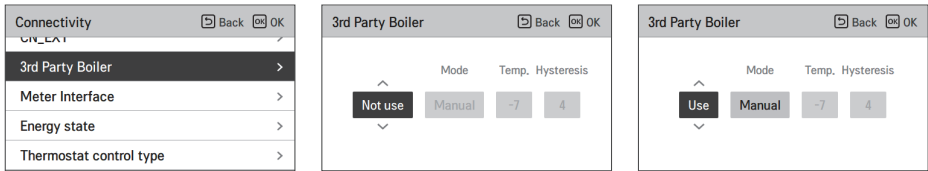

If the status of this function is "Use", you can choose control mode of boiler, Auto or Manual.

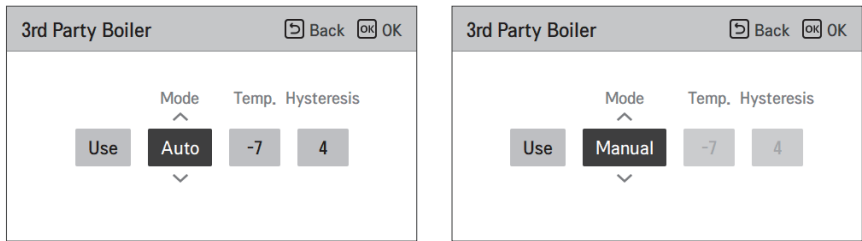

If the mode of this function is set to "Auto", you can set temperature of the boiler and hysteresis, respectively.

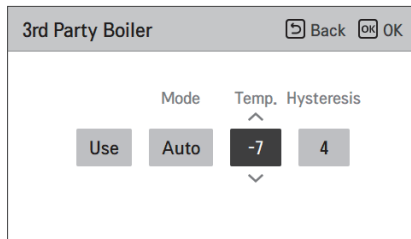

External boiler ON condition :

- If outdoor temperature  $\leq$  external boiler operation temperature value (installer setting), turn off the indoor unit and operate the external boiler.

External boiler OFF condition :

- If External air temperature  $\geq$  external boiler operation temperature value (installer setting) + Hysteresis (installer setting), turn off external boiler operation and operate indoor unit

## Meter Interface

It is the function that can check the status of energy and power on screen. It collects and calculates power or calorie data to create data for energy monitoring and energy warning alarm pop-ups. This function can be activated in installer mode.

| Connectivity            | Back | OK | OK |
|-------------------------|------|----|----|
| CONNECT                 |      |    |    |
| 3rd Party Boiler        |      |    | >  |
| <b>Meter Interface</b>  |      |    | >  |
| Energy state            |      |    | >  |
| Thermostat control type |      |    | >  |

| Meter Interface       | Back | OK | OK |
|-----------------------|------|----|----|
| <b>Modbus Address</b> |      |    | >  |
| Unit                  |      |    | >  |
|                       |      |    |    |



| Modbus Address | Back | OK | OK |
|----------------|------|----|----|
| Modbus Address |      |    |    |
| Not use        |      |    | ∨  |

| Modbus Address | Back | OK | OK |
|----------------|------|----|----|
| Modbus Address |      |    |    |
| B0             |      |    | ∨  |

| Modbus Address | Back | OK | OK |
|----------------|------|----|----|
| Modbus Address |      |    |    |
| B1             |      |    | ∨  |

There are 2 options, modbus address and unit, in this function. Activating the modbus address option, you choose one address(B0 or B1) or don't use. Then, you set the port and specification in range of 0000.0~9999.9[pulse/kWh] as shown in the figure below.

| Unit      | Back | OK | OK |
|-----------|------|----|----|
| Pulse/kWh |      |    |    |
| Port1     | 0    | 0  | 0  |
|           | 0    | 0  | 0  |
|           | .    | 0  |    |

| Unit      | Back | OK | OK |
|-----------|------|----|----|
| Pulse/kWh |      |    |    |
| Port1     | 1    | 1  | 1  |
|           | 1    | 1  | 1  |
|           | .    | 1  |    |

## Current flow rate

It is the function to check the current flow rate.

- In the installer setting list, select Current Flow Rate category, and press [OK] button to move to the detail screen. The current flow rate can be checked. (Range : 7 ~ 80 L/min)
- The function is not available for some products.

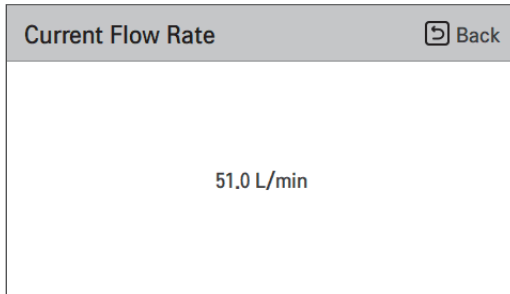
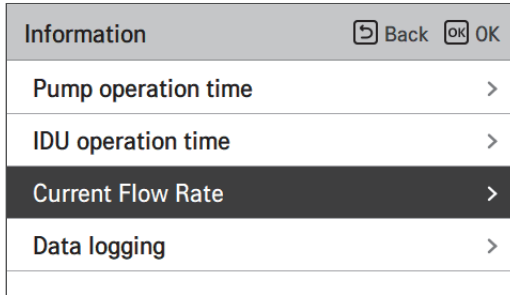

## Data logging

This function is to check the operation and error history.

- In the installer setting list, select Data logging category, and press [OK] button to move to the detail screen.

| Information         | ⏪ Back | OK |
|---------------------|--------|----|
| Pump operation time | >      |    |
| IDU operation time  | >      |    |
| Current Flow Rate   | >      |    |
| <b>Data logging</b> | >      |    |



| Data logging |       |       |         |           | ⏪ Back |
|--------------|-------|-------|---------|-----------|--------|
| Date         | Time  | Oper. | Settemp | In/Out    |        |
| 2020.07.02   | 03:01 | Cool  | 16°     | 25° / 25° |        |
| 2020.07.02   | 02:57 | Cool  | 16°     | 25° / 25° |        |
| 2020.07.02   | 02:31 | Cool  | 16°     | 25° / 25° | >      |
| 2020.07.02   | 02:27 | Cool  | 16°     | 25° / 25° |        |
| 2020.07.02   | 02:01 | Cool  | 16°     | 25° / 25° |        |

### NOTE

Error history lookup range: 50

Error history information

Item: date, time, mode (including Off), set temperature, incoming temperature, outgoing temperature, room temperature, Hot water operation / stop, Hot water set temperature, Hot water temperature, Outdoor unit On / Off, Error code

Number of Display: Within 50

- Save criteria ▾

▸ Error occurred, released ON / OFF of outdoor unit operation.

# Overview settings (For 4 Series)

## Menu Structure

|      |              |                              |     |
|------|--------------|------------------------------|-----|
| Menu |              |                              |     |
|      | Sub function |                              |     |
|      |              | Service Contact              | 124 |
|      |              | Model information            | 125 |
|      |              | RMC Version Information      | 126 |
|      |              | Open Source License          | 127 |
|      | Installer    |                              |     |
|      |              | Select Temperature Sensor    | 184 |
|      |              | Use Heating Tank Heater      | 185 |
|      |              | Mixing Circuit               | 186 |
|      |              | Use External Pump            | 187 |
|      |              | RMC master/slave             | 188 |
|      |              | LG Therma V Configuration    | 189 |
|      |              | Forced operation             | 190 |
|      |              | Pump Prerun/Overrun          | 191 |
|      |              | Water Flow Control           | 192 |
|      |              | Energy Monitoring            | 193 |
|      |              | Anti-Freezing Option 1       | 194 |
|      |              | Password Reset               | 195 |
|      |              | Screed drying                | 196 |
|      |              | Heater on temperature        | 198 |
|      |              | Air heating set temp.        | 200 |
|      |              | Water heating set temp.      | 201 |
|      |              | Hysteresis Room Air(Heating) | 202 |
|      |              | Hysteresis Heating Water     | 203 |
|      |              | Heating temp. setting        | 204 |
|      |              | Pump setting in heating      | 205 |

|   |                                       |       |     |
|---|---------------------------------------|-------|-----|
| → | Air cooling set temp.                 | ..... | 206 |
| → | Water cooling set temp.               | ..... | 207 |
| → | Water supply off temp. during cooling | ..... | 208 |
| → | Hysteresis Room Air(Cooling)          | ..... | 210 |
| → | Hysteresis Cooling Water              | ..... | 211 |
| → | Cooling temp. setting                 | ..... | 212 |
| → | Pump setting in cooling               | ..... | 213 |
| → | Seasonal auto temp.                   | ..... | 214 |
| → | Heater priority                       | ..... | 217 |
| → | DHW set temp.                         | ..... | 218 |
| → | Tank disinfection setting 1, 2        | ..... | 219 |
| → | Tank setting 1                        | ..... | 220 |
| → | Tank setting 2                        | ..... | 221 |
| → | DHW time setting                      | ..... | 223 |
| → | Recirculation time                    | ..... | 224 |
| → | Solar Thermal System                  | ..... | 225 |
| → | Pump test run                         | ..... | 227 |
| → | Frost Protection Temp.                | ..... | 228 |
| → | Dry Contact Mode                      | ..... | 229 |
| → | Central Control Address               | ..... | 230 |
| → | CN_CC                                 | ..... | 231 |
| → | LG Therma V Configuration             | ..... | 232 |
| → | Pump frequency setting (RPM)          | ..... | 233 |
| → | Smart Grid(SG)                        | ..... | 234 |
| → | Power Supply Blockage (Smart Grid)    | ..... | 235 |
| → | Energy state                          | ..... | 236 |
| → | Thermostat control type               | ..... | 237 |

|   |                           |       |     |
|---|---------------------------|-------|-----|
| → | Pump operation time       | ..... | 238 |
| → | IDU operation time        | ..... | 239 |
| → | Modbus Address            | ..... | 240 |
| → | Modbus gateway memory map | ..... | 241 |
| → | CN_EXT                    | ..... | 244 |
| → | 3rd Party Boiler          | ..... | 245 |
| → | Meter Interface           | ..... | 246 |
| → | Current flow rate         | ..... | 247 |
| → | Data logging              | ..... | 248 |
| → | Overview settings         | ..... | 249 |

# COMMISSIONING

If everything is going well until now, it is time to start the operation and to take advantages of **THERMAV.**

Before starting operation, pre-check points are described in this chapter. Some comments about maintenance and how to do troubleshooting are presented.

## Check List before Starting Operation

### CAUTION

Turn off the power before changing wiring or handling product

| No | Category             | Item                   | Check Point   |
|----|----------------------|------------------------|---|
| 1  | Electricity          | Field wiring           | <ul style="list-style-type: none"> <li>All switches having contacts for different poles should be wired tightly according to regional or national legislation.</li> <li>Only qualified person can proceed wiring.</li> <li>Wiring and local-supplied electric parts should be complied with European and regional regulations.</li> <li>Wiring should be following the wiring diagram supplied with the product.</li> </ul> |
| 2  |                      | Protective devices     | <ul style="list-style-type: none"> <li>Install ELB (earth leakage breaker) with 30 mA.</li> <li>ELB inside the control box of the unit should be turned on before starting operation.</li> </ul>  |
| 3  |                      | Earth wiring           | <ul style="list-style-type: none"> <li>Earth should be connected. Do not earth to gas or city water pipe, metallic section of a building, surge absorber, etc.</li> </ul>   |
| 4  |                      | Power supply           | <ul style="list-style-type: none"> <li>Use dedicated power line.</li> </ul>   |
| 5  |                      | Terminal block wiring  | <ul style="list-style-type: none"> <li>Connections on the terminal block (inside the control box of the unit) should be tightened.</li> </ul>   |
| 6  | Water                | Charged water pressure | <ul style="list-style-type: none"> <li>After water charging, the pressure gauge (in front of the unit) should indicate 2.0~2.5 bar. Do not exceed 3.0 bar.</li> </ul>   |
| 7  |                      | Air purge              | <ul style="list-style-type: none"> <li>During water charging, air should be taken out through the hole of the air purge.</li> <li>If water does not splash out when the tip (at the top of the hole) is pressed, then air purging is not completed yet. If well purged, the water will splash out like fountain.</li> <li>Be careful when testing air purge. Splashed water may make your dress wet.</li> </ul>             |
| 8  |                      | Shut-off valve         | <ul style="list-style-type: none"> <li>Two shut-off valves (located at the end of water inlet pipe and water outlet pipe of the unit) should be open.</li> </ul>  |
| 9  |                      | By-pass valve          | <ul style="list-style-type: none"> <li>By-pass valve should be installed and adjusted to secure enough water flow rate. If water flow rate is low, flow switch error (CH14) can be occurred.</li> </ul>   |
| 10 | Product Installation | Hang to the wall       | <ul style="list-style-type: none"> <li>As the unit is hung on the wall, vibration or noise can be heard if the unit is not fixed tightly.</li> <li>If the unit is not fixed tightly, it can fall down during operation.</li> </ul>  |
| 11 |                      | Parts inspection       | <ul style="list-style-type: none"> <li>There should be no apparently damaged parts inside the unit.</li> </ul>  |
| 12 |                      | Refrigerant leakage    | <ul style="list-style-type: none"> <li>Refrigerant leakage degrades the performance. If leakage found, contact qualified LG air conditioning installation person.</li> </ul>  |
| 13 |                      | Drainage treatment     | <ul style="list-style-type: none"> <li>While cooling operation, condensed dew can drop down to the bottom of the unit. In this case, prepare drainage treatment (for example, vessel to contain condensed dew) to avoid water drop.</li> </ul>  |

To assure best performance of **THERMAV**®, it is required to perform periodical check and maintenance. It is recommended to proceed following check list for once a year.

## CAUTION

Turn off the power before proceeding maintenance

| No | Category    | Item                    | Check Point   |
|----|-------------|-------------------------|---|
| 1  | Water       | Water pressure          | <ul style="list-style-type: none"> <li>• In normal state, the pressure gauge (in front of the unit) should indicate 2.0~2.5 bar.</li> <li>• If the pressure is less than 0.3 bar, please recharge the water.</li> </ul>       |
| 2  |             | Strainer (Water filter) | <ul style="list-style-type: none"> <li>• Close the shut-off valves and disassemble strainer. Then wash the strainer to make it clean.</li> <li>• While disassembling the strainer, be careful for water flood out.</li> </ul> |
| 3  |             | Safety valve            | <ul style="list-style-type: none"> <li>• Open the switch of the safety valve and check if water is flood out through the drain hose.</li> <li>• After checking, close the safety valve.</li> </ul>                            |
| 4  | Electricity | Terminal block wiring   | <ul style="list-style-type: none"> <li>• Look and inspect if there is loosen or defected connection on the terminal block.</li> </ul>   |

## Starting Operation

### Check before Starting Operation

|   |   |
|---|---|
| 1 | Check to see whether there is any refrigerant leakage, and check whether the power or transmission cable is connected properly.   |
| 2 | <p>Confirm that 500 V megger shows 2.0 MΩ or more between power supply terminal block and ground. Do not operate in the case of 2.0 MΩ or less.</p> <p><b>NOTE:</b><br/>Never carry out mega ohm check over terminal control board. Otherwise the control board may break.</p> <p>Immediately after mounting the unit or after leaving it turned off for an extended length of time, the resistance of the insulation between the power supply terminal board and the ground may decrease to approx. 2.0 MΩ as a result of refrigerant accumulation in the internal compressor.</p> <p>If the insulation resistance is less than 2.0 MΩ, turn on the main power supply.</p> |
| 3 | When the power is applied for the first time, operate the product after preheating for 2 hours. To protect the unit by increasing the oil temperature of the compressor.  |

## Starting Operation flow chart

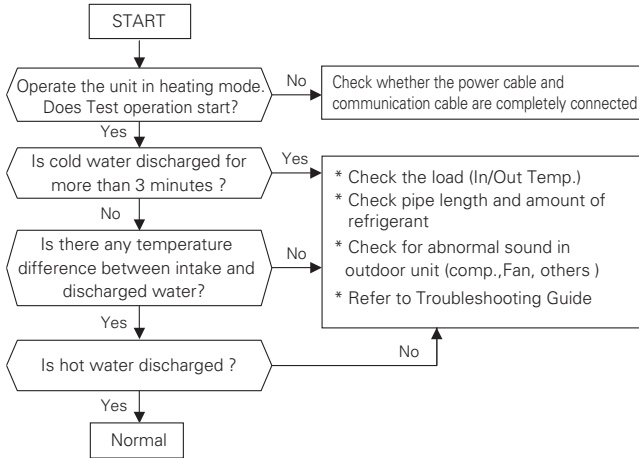

## Airborne Noise Emission

The A-weighted sound pressure emitted by this product is below 70 dB.

\*\* The noise level can vary depending on the site.

The figures quoted are emission level and are not necessarily safe working levels.

Whilst there is a correlation between the emission and exposure levels, this cannot be used reliably to determine whether or not further precautions are required.

Factor that influence the actual level of exposure of the workforce include the characteristics of the work room and the other sources of noise, i.e. the number of equipment and other adjacent processes and the length of time for which an operator exposed to the noise.

Also, the permissible exposure level can vary from country to country.

This information, however, will enable the user of the equipment to make a better evaluation of the hazard and risk.

# Vacuum & Charge of Refrigerant

By default, the product was charged of refrigerant.  
 Vacuum and refrigerant charge, If there is leak refrigerant.

## 1. Vacuum

To work of vacuum action. when the leak of refrigerant.

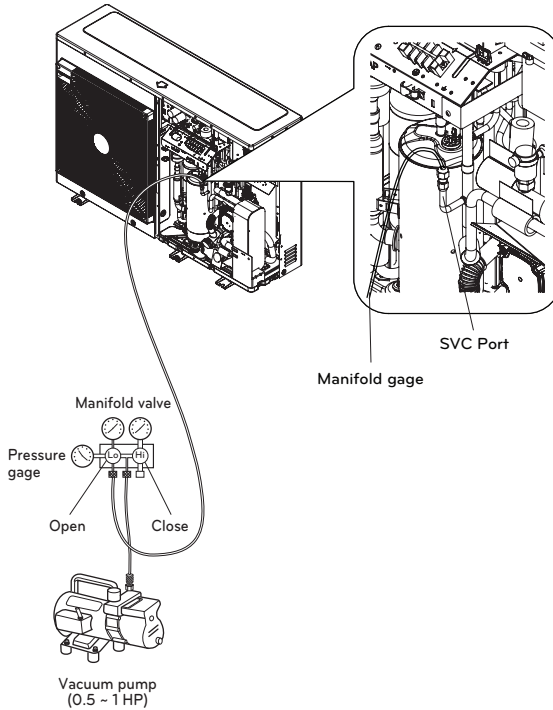

When selecting a vacuum, you should select one which is capable of achieving 0.2 Torr of ultimate vacuum.

|                   | Unit                  | Standard atmospheric pressure | Perfect vacuum |
|-------------------|-----------------------|-------------------------------|----------------|
| Gage Pressure     | Pa                    | 0                             | -1.033         |
| Absolute Pressure | kgf / cm <sup>2</sup> | 1.033                         | 0              |

※ 0 Pa(gage)=1 atm=760 Torr=760 mmHg=1 013.25 hPa

\* The feature may be vary according to the type of model.

## 2. Charge of refrigerant

You should be charged after vacuum.

You can see amount of refrigerant at quality label.

Please to charge at cooling mode when there is not full charging.

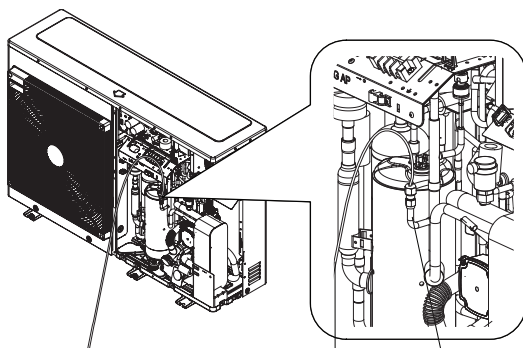

Manifold gage SVC Port

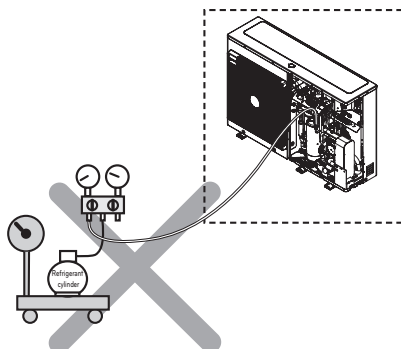
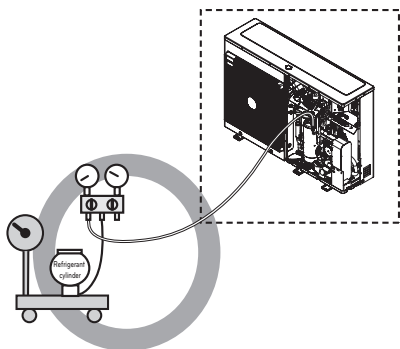
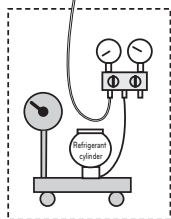

\* The feature may be vary according to the type of model.

### 3. Location of SVC port

UN36A (5, 7, 9 kW)

UN60A (9, 12, 14, 16 kW)

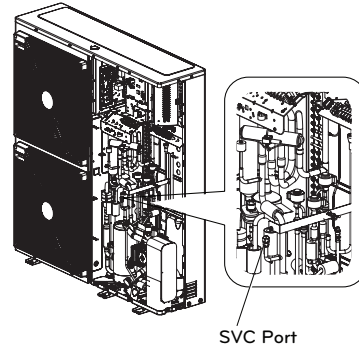
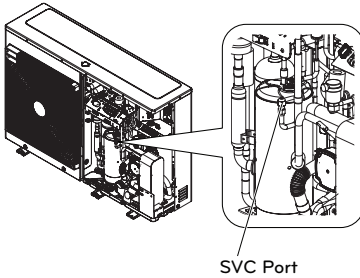

### How to drain remaining water in the product

#### ⚠ CAUTION

If the product is not used for a long period of time with remaining water, there is a risk of freezing in winter.

#### Step1

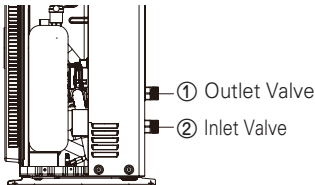

**Step1.** To drain most of the water out of the product, remove the water pipes from the inlet/outlet valve(①,②). After draining, reconnect them.

#### Step2

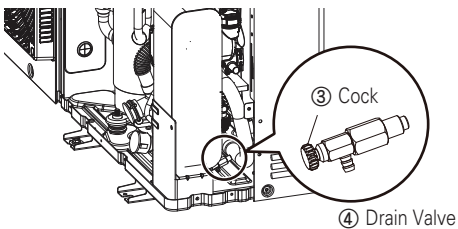

**Step2.** To drain the rest of the water out of the product, open the cock(③) of the drain valve(④) counterclockwise. After draining, lock it in the opposite direction to the end.

- To use the product again, you have to refill water in it. Refer to 'Water Charging' of 'Installation' part in this manual.

\* The feature may vary according to the type of model.

## Troubleshooting

If **THERMAV** operates not properly or it does not start operation, please check following list.

### CAUTION

Turn off the power before proceeding troubleshooting

### Troubleshooting for Problem while Operation

| No | Problem   | Reason   | Solution   |
|----|---|--|--|
| 1  | Heating or Cooling is not satisfactory.   | <ul style="list-style-type: none"> <li>Setting target temperature is not proper.</li> </ul>            | <ul style="list-style-type: none"> <li>Set target temperature correctly.</li> <li>Check if temperature is water-based or air-based. See 'Remote sensor active' and 'Temp. sensor selection' in Chapter6.</li> </ul>  |
|    |   | <ul style="list-style-type: none"> <li>Charged water is not enough.</li> </ul>                         | <ul style="list-style-type: none"> <li>Check pressure gage and charge more water until pressure gage is indication 2~2.5 Bar</li> </ul>  |
|    |   | <ul style="list-style-type: none"> <li>Water flow rate is low.</li> </ul>                              | <ul style="list-style-type: none"> <li>Check if strainer gathers too much particles. If so, strainer should be cleaned.</li> <li>Check if pressure gage indicates above 4 Bar</li> <li>Check if water pipe is getting closed due to stacked particles or lime.</li> </ul>  |
| 2  | Although electric power supply is OK (remote controller displays information), the unit does not start working. | <ul style="list-style-type: none"> <li>Water inlet temperature is too high.</li> </ul>                 | <ul style="list-style-type: none"> <li>If water inlet temperature is above 57 °C, the unit does not operated for the sake of system protection</li> </ul>  |
|    |   | <ul style="list-style-type: none"> <li>Water inlet temperature is too low.</li> </ul>                  | <ul style="list-style-type: none"> <li>If water inlet temperature is below 5 °C in cooling operation, the unit does not operated for the sake of system protection. Wait while unit warms up the water inlet temperature.</li> <li>If water inlet temperature is below 15 °C in heating operation, the unit does not operated for the sake of system protection. Wait while unit warms up to 18 °C the water inlet temperature.</li> <li>If you are not using the back up heater accessory (HA**1M E1), increase the water temperature with the external heat source (heater, boiler). If the problem persists, contact your dealer.</li> <li>If you want to use the screed drying function, be sure to purchase and install back up hater accessories (HA**1M E1).</li> </ul> |
| 3  | Water pump noise.   | <ul style="list-style-type: none"> <li>Air purging is not completely finished.</li> </ul>              | <ul style="list-style-type: none"> <li>Open the cap of air purge and charge more water until pressure gage is indicating 2~2.5 Bar</li> <li>If water does not splash out when the tip(at the top of the hole) is pressed, then air purging is not completed yet. If well purged, the water will splash out like fountain.</li> </ul>   |
|    |   | <ul style="list-style-type: none"> <li>Water pressure is low.</li> </ul>                               | <ul style="list-style-type: none"> <li>Check if pressure gage indicates above 0.3 Bar.</li> <li>Check if the expansion tank and pressure gage operates well.</li> </ul>  |
| 4  | Water is flood out through drain hose.  | <ul style="list-style-type: none"> <li>Too much water is charged.</li> </ul>                           | <ul style="list-style-type: none"> <li>Flood out water by opening the switch of the safety valve until pressure gage is indicating 2~2.5 Bar.</li> </ul>   |
|    |   | <ul style="list-style-type: none"> <li>Expansion tank is damaged.</li> </ul>                           | <ul style="list-style-type: none"> <li>Replace the expansion tank</li> </ul>   |
| 5  | DHW is not hot.   | <ul style="list-style-type: none"> <li>Thermal protector of water tank heater is activated.</li> </ul> | <ul style="list-style-type: none"> <li>Open the side panel of the DHW tank and push the reset button of the thermal protector. (for more detail information, please refer to installation manual of DHW tank.</li> </ul>   |
|    |   | <ul style="list-style-type: none"> <li>DHW Heating is disabled.</li> </ul>                             | <ul style="list-style-type: none"> <li>Select DHW Heating Operation and identify if icon is displayed on the remote controller.</li> </ul>   |

## Troubleshooting for Error Code

| Display code | Title  | Cause of error  | Check point & Normal condition   |
|--------------|--|---|--|
| 1            | Problem in remote room air sensor  | <ul style="list-style-type: none"> <li>• Incorrect connection between sensor and PCB(Heater).</li> <li>• PCB(Heater) fault</li> <li>• Sensor fault</li> </ul>   | <ul style="list-style-type: none"> <li>• Resistance: 10 kΩ at 25 centigrade (unplugged) → for Remote room air sensor</li> <li>• Resistance: 5 kΩ at 25 centigrade (unplugged) → for all sensors EXCEPT remote room air sensor</li> <li>• Voltage: 2.5 V DC at 25 centigrade (plugged) (for all sensors)</li> <li>• Refer resistance-temperature table to check in different temperature</li> </ul> |
| 2            | Problem in refrigerant (inlet side) sensor   |   |  |
| 6            | Problem in refrigerant (outlet side) sensor  |   |  |
| 8            | Problem in water tank sensor   |   |  |
| 13           | Problem in solar pipe sensor   |   |  |
| 16           | Problems in sensors  |   |  |
| 17           | Problem in water-inlet sensor  |   |  |
| 18           | Problem in water-outlet sensor   |   |  |
| 19           | Problem in electric heater outlet sensor   |   |  |
| 10           | BLDC Water pump Lock   | Restriction of BLDC Water pump  | <ul style="list-style-type: none"> <li>• BLDC Water pump defect / assembly condition abnormal</li> <li>• Fan lock by foreign material</li> </ul>   |
| 3            | Bad communication between remote controller and unit.  | <ul style="list-style-type: none"> <li>• Incorrect connection between sensor and PCB(Heater)</li> <li>• PCB(Heater) fault</li> <li>• Sensor fault</li> </ul>  | <ul style="list-style-type: none"> <li>• Wire connection between remote controller and Main PCB assembly(Heater) should be tight</li> <li>• Output voltage of PCB should be 12 V DC</li> </ul>   |
| 5            | Bad communication between Main PCB assembly(Heater) and Main PCB assembly(Inverter) of the unit. | <ul style="list-style-type: none"> <li>• The connector for transmission is disconnected</li> <li>• The connecting wires are misconnected</li> <li>• The communication line is broken</li> <li>• Main PCB assembly(Inverter) is abnormal</li> <li>• Main PCB assembly(Heater) is abnormal</li> </ul> | <ul style="list-style-type: none"> <li>• Wire connection between remote control panel and Main PCB assembly(Heater) should be tight.</li> </ul>  |
| 53           |  |   |  |
| 9            | PCB program (EEPROM) fault   | <ul style="list-style-type: none"> <li>• Electrical or mechanical damage a the EEPROM</li> </ul>  | <ul style="list-style-type: none"> <li>• This error can not be permitted</li> </ul>  |
| 14           | Problem in flow switch   | <ul style="list-style-type: none"> <li>• Flow switch is open while internal water pump is working</li> </ul>  | <ul style="list-style-type: none"> <li>• Flow switch should be closed while internal water pump is working</li> </ul>  |
| 15           | Water pipe overheated  | <ul style="list-style-type: none"> <li>• Abnormal operation of electric heater</li> <li>• Leaving water temperature is above 72 °C.</li> </ul>  | <ul style="list-style-type: none"> <li>• If there is no problem in electric heater control, possible maximum leaving water temperature is 72 °C</li> </ul>   |
| 20           | Thermal fuse is damaged  | <ul style="list-style-type: none"> <li>• Thermal fuse is cut off by abnormal overheating of internal electric heater</li> <li>• Mechanical fault at thermal fuse</li> <li>• Wire is damaged</li> </ul>  | <ul style="list-style-type: none"> <li>• This error will not be happened if temperature of electric heater tank is below 80 °C</li> </ul>  |

| Display code | Title   | Cause of error  | Check point & Normal condition   |
|--------------|---|---|--|
| 21           | DC PEAK (IPM Fault)   | <ul style="list-style-type: none"> <li>Instant over current</li> <li>Over Rated current</li> <li>Poor insulation of IPM</li> </ul>  | <ul style="list-style-type: none"> <li>An instant over current in the U,V,W phase               <ul style="list-style-type: none"> <li>- Comp lock</li> <li>- The abnormal connection of U,V,W</li> </ul> </li> <li>Over load condition               <ul style="list-style-type: none"> <li>- Overcharging of refrigerant Pipe length.</li> <li>Outdoor Fan is stop</li> </ul> </li> <li>Poor insulation of compressor</li> </ul>                             |
| 22           | Max. C/T  | Input Over Current  | <ul style="list-style-type: none"> <li>Malfunction of Compressor</li> <li>Blocking of Pipe</li> <li>Low Voltage Input</li> <li>Refrigerant, Pipe length, Blocked...</li> </ul>   |
| 23           | DC Link High / Low Volt                                       | <ul style="list-style-type: none"> <li>DC Link Voltage is above 420 V DC</li> <li>DC Link Voltage is below 140 V DC</li> </ul>  | <ul style="list-style-type: none"> <li>Check CN_(L), CN_(N) Connection</li> <li>Check Input Voltage</li> <li>Check PCB DC Link voltage sensor parts</li> </ul>   |
| 24           | Low/High Pressure Switch Perception Error                     | <ul style="list-style-type: none"> <li>Low pressure is below 0.2 kgf/cm<sup>2</sup>.</li> <li>High pressure is above 42~44 kgf/cm<sup>2</sup>.</li> <li>Pressure switch is self-defective.</li> </ul>   | <ul style="list-style-type: none"> <li>Check the low/high pressure</li> <li>Check the connection of harness</li> </ul>   |
| 26           | DC Compressor Position  | <ul style="list-style-type: none"> <li>Compressor Starting fail error</li> </ul>  | <ul style="list-style-type: none"> <li>Check the connection of comp wire "U,V,W"</li> <li>Malfunction of compressor</li> <li>Check the component of "IPM", detection parts.</li> </ul>   |
| 27           | AC Input Instant over Current Error                           | PCB(Inverter) input current is over 100 A(peak) for 2 us  | <ul style="list-style-type: none"> <li>Overload operation (Pipe clogging/Covering/EEV defect/Ref. overcharge)</li> <li>Compressor damage (Insulation damage/Motor damage)</li> <li>Input voltage abnormal (L,N)</li> <li>Power line assemble condition abnormal</li> <li>PCB assembly 1 Damage (input current sensing part)</li> </ul>   |
| 29           | Inverter compressor over current                              | (HM**1M U*3) Inverter Compressor input current is 35 Apk.<br>(HM**3M U*3) Inverter Compressor input current is 35 Apk.  | <ul style="list-style-type: none"> <li>Overload operation (Pipe clogging/Covering/EEV defect/Ref. overcharge)</li> <li>Compressor damage(Insulation damage/Motor damage)</li> <li>Input voltage low</li> <li>ODU PCB assembly 1 damage</li> </ul>  |
| 32           | High temperature in Discharge pipe of the inverter compressor | <ul style="list-style-type: none"> <li>Overload operation (Outdoor fan constraint, screened, blocked)</li> <li>Refrigerant leakage (insufficient)</li> <li>Poor INV Comp Discharge sensor</li> <li>LEV connector displaced / poor LEV assembly</li> </ul> | <ul style="list-style-type: none"> <li>Check outdoor fan constraint/ screened/ flow structure</li> <li>Check refrigerant leakage</li> <li>Check if the sensor is normal</li> <li>Check the status of EEV assembly</li> </ul>   |
| 35           | Low pressure Error  | Excessive decrease of low pressure  | <ul style="list-style-type: none"> <li>Defective low pressure sensor</li> <li>Defective unit fan</li> <li>Refrigerant shortage/leakage</li> <li>Deformation because of damage of refrigerant pipe</li> <li>Defective unit EEV</li> <li>Covering / clogging (unit covering during the cooling mode / unit filter clogging during heating mode)</li> <li>SVC valve clogging</li> <li>Defective unit PCB(Inverter)</li> <li>Defective unit pipe sensor</li> </ul> |

| Display code | Title   | Cause of error  | Check point & Normal condition   |
|--------------|---|---|--|
| 41           | Problem in D-pipe temperature sensor            | <ul style="list-style-type: none"> <li>• Open / Short</li> <li>• Soldered poorly</li> <li>• Internal circuit error</li> </ul>   | <ul style="list-style-type: none"> <li>• Bad connection of thermistor connector</li> <li>• Defect of thermistor connector (Open/Short)</li> <li>• Defect of outdoor PCB(Inverter)</li> </ul>   |
| 43           | Problem in high pressure sensor                 | Abnormal value of sensor (Open/Short)   | <ul style="list-style-type: none"> <li>• Bad connection of connector PCB(Inverter)</li> <li>• Bad connection high pressure connector</li> <li>• Defect of high pressure connector (Open/Short)</li> <li>• Defect of connector PCB(Inverter) (Open/Short)</li> <li>• Defect of PCB(Inverter)</li> </ul>   |
| 44           | Problem in outdoor air temperature sensor       | <ul style="list-style-type: none"> <li>• Open / Short</li> <li>• Soldered poorly</li> <li>• Internal circuit error</li> </ul>   | <ul style="list-style-type: none"> <li>• Bad connection of thermistor connector</li> <li>• Defect of thermistor connector (Open/Short)</li> <li>• Defect of outdoor PCB(Inverter)</li> </ul>   |
| 45           | Problem in Cond. middle pipe temperature sensor | <ul style="list-style-type: none"> <li>• Open / Short</li> <li>• Soldered poorly</li> <li>• Internal circuit error</li> </ul>   | <ul style="list-style-type: none"> <li>• Bad connection of thermistor connector</li> <li>• Defect of thermistor connector (Open/Short)</li> <li>• Defect of outdoor PCB(Inverter)</li> </ul>   |
| 46           | Problem in suction pipe temperature sensor      | <ul style="list-style-type: none"> <li>• Open / Short</li> <li>• Soldered poorly</li> <li>• Internal circuit error</li> </ul>   | <ul style="list-style-type: none"> <li>• Bad connection of thermistor connector</li> <li>• Defect of thermistor connector (Open/Short)</li> <li>• Defect of outdoor PCB(Inverter)</li> </ul>   |
| 52           | PCB Communication Error                         | Checking the communication state between Main PCB and Inverter PCB  | <ul style="list-style-type: none"> <li>• Generation of noise source interfering with communication</li> </ul>  |
| 54           | Open and Reverse Phase Error                    | Prevention of phase unbalance and prevention of reverse rotation of constant-rate compressor  | <ul style="list-style-type: none"> <li>• Main power wiring fault</li> </ul>  |
| 60           | PCB(Inverter) & Main EEPROM check sum error     | EEPROM Access error and Check SUM error   | <ul style="list-style-type: none"> <li>• EEPROM contact defect/wrong insertion</li> <li>• Different EEPROM Version</li> <li>• ODU Inverter &amp; Main PCB assembly 1 damage</li> </ul>   |
| 61           | High temperature in Cond. Pipe                  | <ul style="list-style-type: none"> <li>• Overload operation (Outdoor fan constraint, screened, blocked)</li> <li>• Unit heat exchanger contaminated</li> <li>• EEV connector displaced / poor EEV assembly</li> <li>• Poor Cond. Pipe sensor assembly / burned</li> </ul> | <ul style="list-style-type: none"> <li>• Check outdoor fan constraint / screened / flow structure</li> <li>• Check if refrigerant overcharged</li> <li>• Check the status of EEV assembly</li> <li>• Check the status of sensor assembly / burn</li> </ul>   |
| 62           | Heat sink Temp, High error                      | Heatsink temperature is greater than 110 °C.  | <ul style="list-style-type: none"> <li>• Part no. : EBR37798101-09 <ul style="list-style-type: none"> <li>- Check the heatsink sensor: 10 kΩ / at 25 °C(Unplugged)</li> <li>- Check the outdoor fan is driving rightly</li> </ul> </li> <li>• Part no. : EBR37798112-21 <ul style="list-style-type: none"> <li>- Check the soldered condition in the 22,23 pin of IPM, PFCM</li> <li>- Check the screw torque of IPM, PFCM</li> <li>- Check the spreadable condition of thermal grease on IPM, PFCM</li> <li>- Check the outdoor fan is driving rightly</li> </ul> </li> </ul> |
| 65           | Problem in Heatsink Temperature sensor          | Abnormal value of sensor (Open/Short)   | <ul style="list-style-type: none"> <li>• Check if there is defect of thermistor connector (Open/Short)</li> <li>• Check defect of outdoor PCB(Inverter)</li> </ul>   |

| Display code | Title  | Cause of error  | Check point & Normal condition  |
|--------------|--|---|---|
| 67           | Fan lock error                                       | Fan RPM is less than 10 for 5 seconds from start-up operation.<br>Fan RPM is less than 40 in operation except for start-up operation                        | <ul style="list-style-type: none"> <li>• Fan motor damage</li> <li>• Assembly condition abnormal</li> <li>• Jammed fan by surroundings</li> </ul>   |
| 114          | Problem in Vapor injection inlet temperature sensor  | <ul style="list-style-type: none"> <li>• Open (Below -48.7 °C)/ Short(Over 96.2 °C)</li> <li>• Soldered poorly</li> <li>• Internal circuit error</li> </ul> | <ul style="list-style-type: none"> <li>• Bad connection of thermistor connector</li> <li>• Defect of thermistor connector (Open/Short)</li> <li>• Defect of outdoor PCB(Outdoor)</li> </ul> |
| 115          | Problem in Vapor injection outlet temperature sensor | <ul style="list-style-type: none"> <li>• Open (Below -48.7 °C)/ Short(Over 96.2 °C)</li> <li>• Soldered poorly</li> <li>• Internal circuit error</li> </ul> | <ul style="list-style-type: none"> <li>• Bad connection of thermistor connector</li> <li>• Defect of thermistor connector (Open/Short)</li> <li>• Defect of outdoor PCB(Outdoor)</li> </ul> |



LG Electronics Inc. Single Point of Contact (EU/UK) :  
LG Electronics European Shared Service Center B.V.  
Krijgsman 1, 1186 DM Amstelveen, The Netherlands

Manufacturer :  
LG Electronics Inc.  
84, Wanam-ro, Seongsan-gu, Changwon-si, Gyeongsangnam-do, KOREA

UK Importer :  
LG Electronics U.K. Ltd  
Velocity 2, Brooklands Drive, Weybridge, KT13 0SL

**Eco design requirement**

- The information for Eco design is available on the following free access website.  
<https://www.lg.com/global/support/cedoc/cedoc>