

INSTALLATION MANUAL

AIR CONDITIONER

Please read this installation manual completely before installing the product. Installation work must be performed in accordance with the national wiring standards by authorized personnel only. Please retain this installation manual for future reference after reading it thoroughly.

Ceiling Concealed Duct



MFL67939936
Rev.06_032221

www.lg.com

Copyright © 2018 - 2021 LG Electronics Inc. All Rights Reserved.

TIPS FOR SAVING ENERGY

Here are some tips that will help you minimize the power consumption when you use the air conditioner. You can use your air conditioner more efficiently by referring to the instructions below:

- Do not cool excessively indoors. This may be harmful for your health and may consume more electricity.
- Block sunlight with blinds or curtains while you are operating the air conditioner.
- Keep doors or windows closed tightly while you are operating the air conditioner.
- Adjust the direction of the air flow vertically or horizontally to circulate indoor air.
- Speed up the fan to cool or warm indoor air quickly, in a short period of time.
- Open windows regularly for ventilation as the indoor air quality may deteriorate if the air conditioner is used for many hours.
- Clean the air filter once every 2 weeks. Dust and impurities collected in the air filter may block the air flow or weaken the cooling / dehumidifying functions.

For your records

Staple your receipt to this page in case you need it to prove the date of purchase or for warranty purposes. Write the model number and the serial number here:

Model number : _____

Serial number : _____

You can find them on a label on the side of each unit.

Dealer's name : _____

Date of purchase : _____

IMPORTANT SAFETY INSTRUCTIONS

READ ALL INSTRUCTIONS BEFORE USING THE APPLIANCE.

Always comply with the following precautions to avoid dangerous situations and ensure peak performance of your product.

WARNING

It can result in serious injury or death when the directions are ignored.

CAUTION

It can result in minor injury or product damage when the directions are ignored.

WARNING

- Installation or repairs made by unqualified persons can result in hazards to you and others.
- Installation of all field wiring and components **MUST** conform with local building codes or, in the absence of local codes, with the National Electrical Code 70 and the National Building Construction and Safety Code or Canadian Electrical code and National Building Code of Canada.
- The information contained in the manual is intended for use by a qualified service technician familiar with safety procedures and equipped with the proper tools and test instruments.
- Failure to carefully read and follow all instructions in this manual can result in equipment malfunction, property damage, personal injury and/or death.

Installation

- Always perform grounding.
 - Otherwise, it may cause electrical shock.
- For installation of the product, always contact the service center or a professional installation agency.
 - Otherwise, it may cause a fire, electrical shock, explosion or injury.
- Securely attach the electrical part cover to the indoor unit and the service panel to the outdoor unit.
 - If the electrical part cover of the indoor unit and the service panel of the outdoor unit are not attached securely, it could result in a fire or electric shock due to dust, water, etc.
- Always install an earth leakage circuit breaker and a dedicated switching board.
 - No installation may cause a fire and electrical shock.
- Do not keep or use flammable gases or combustibles near the air conditioner.
 - Otherwise, it may cause a fire or the failure of product.
- Ensure that an installation frame of the outdoor unit is not damaged due to use for a long time.
 - It may cause injury or an accident.
- Do not disassemble or repair the product randomly.
 - It will cause a fire or electrical shock.
- Do not install the product at a place that there is concern of falling down.
 - Otherwise, it may result in personal injury.
- Use caution when unpacking and installing.
 - Sharp edges may cause injury.
- Use a vacuum pump or Inert (nitrogen) gas when doing leakage test or air purge. Do not compress air or Oxygen and Do not use Flammable gases.
 - Otherwise, it may cause fire or explosion. There is the risk of death, injury, fire or explosion.
- Consult your local dealer regarding what to do in case of refrigerant leakage.

When the air conditioner is to be installed in a small room, it is necessary to take proper measures so that the amount of any leaked refrigerant does not exceed the concentration limit in the event of a leakage.

 - Otherwise, this may lead to an accident due to oxygen depletion.
- Carry out the specified installation work after taking into account earthquakes.

Failure to do so during installation work may result in the unit falling and causing accidents.

4 IMPORTANT SAFETY INSTRUCTIONS

- Make sure that a separate power supply circuit is provided for this unit and that all electrical work is carried out by qualified personnel according to local laws and regulations and this installation manual. An insufficient power supply capacity or improper electrical construction may lead to electric shocks or fire.
- Be sure to switch off the unit before touching any electrical parts.
- Make sure that all wiring is secured, the specified wires are used, and that there is no strain on the terminal connections or wires.
- If refrigerant gas leaks during installation, ventilate the area immediately.
Toxic gas may be produced if the refrigerant gas comes into contact with fire.

Operation

- Turn off the unit if strange sounds, smell, or smoke comes from it.
- Otherwise, it may cause electrical shock or a fire.
- Keep the flames away.
- Otherwise, it may cause a fire.
- Do not touch the power cable with wet hands when it taking out .
- Otherwise, it may cause a fire or electrical shock.
- Do not open the suction inlet of the indoor/outdoor unit during operation.
- Otherwise, it may electrical shock and failure.
- Do not allow water to run into electrical parts.
- Otherwise, it may cause the failure of machine or electrical shock.
- Never touch the metal parts of the unit when removing the filter.
- They are sharp and may cause injury.
- Do not step on the indoor/outdoor unit and do not put anything on it.
- It may cause an injury through dropping of the unit or falling down.
- When the product is submerged into water, always contact the service center.
- Otherwise, it may cause a fire or electrical shock.
- Take care so that children may not step on the outdoor unit.
- Otherwise, children may be seriously injured due to falling down.



CAUTION

Installation

- Install the drain hose to ensure that drain can be securely done.
- Otherwise, it may cause water leakage.
- Install the product so that the noise or hot wind from the outdoor unit may not cause any damage to the neighbors.
- Otherwise, it may cause dispute with the neighbors.
- Always inspect gas leakage after the installation and repair of product.
- Otherwise, it may cause the failure of product.
- Keep level parallel in installing the product.
- Otherwise, it may cause vibration or water leakage.
- Do not install the unit in potentially explosive atmospheres.

Operation

- Avoid excessive cooling and perform ventilation sometimes.
- Otherwise, it may do harm to your health.
- Use a soft cloth to clean. Do not use wax, thinner, or a strong detergent.
- The appearance of the air conditioner may deteriorate, change color, or develop surface flaws.
- Do not use an appliance for special purposes such as preserving animals vegetables, precision machine, or art articles.
- Otherwise, it may damage your properties.
- Do not place obstacles around the flow inlet or outlet.
- Otherwise, it may cause the failure of appliance or an accident.
- Do not turn on the breaker or power under condition that front panel, cabinet, top cover, control box cover are removed or opened.

TABLE OF CONTENTS

2 TIPS FOR SAVING ENERGY

3 IMPORTANT SAFETY INSTRUCTIONS

6 INTRODUCTION

6 Features

7 INSTALLATION OF INDOOR

7 Selection of the best location

7 Installation of Unit

10 Indoor Unit Drain Piping

10 Drain test

11 Thermal insulator

11 Wiring Connection

12 Flaring Work

15 INSTALLATION INSTRUCTION

18 Remote controller installation

19 Group control

20 Installer Setting - How to enter installer setting mode

21 Installer Setting - Test Run Mode

22 Installer Setting - Setting Address of Central Control

23 Installer Setting - E.S.P.

24 Installer Setting - Thermistor

25 Installer Setting - Ceiling Height Selection

26 Installer Setting - Static Pressure Setting

27 Installer Setting - Remote Controller Master/Slave Setup

28 Installer Setting - Auto ESP

31 OPTIONAL OPERATION

31 Installer Setting - Test Run Mode

32 Installer Setting - E.S.P.

33 Installer Setting - Thermistor

34 Installer Setting - Group Setting

35 Installer Setting - Dry Contact Mode Setting

36 Installer Setting - Static Pressure Setting

39 Installer Setting - Auto ESP

42 Installer Setting - How to enter installer setting mode

43 Installer Setting - Test Run Mode

44 Installer Setting - Setting Address of Central Control

45 Installer Setting - E.S.P.

46 Installer Setting - Thermistor

47 Installer Setting - Remote Controller Master/Slave Setup

48 Installer Setting - Celsius / Fahrenheit Switching

49 Installer Setting - Static Pressure Step Setting

50 Installer Setting - Auto ESP

53 DIP SWITCH SETTING

INTRODUCTION

Features

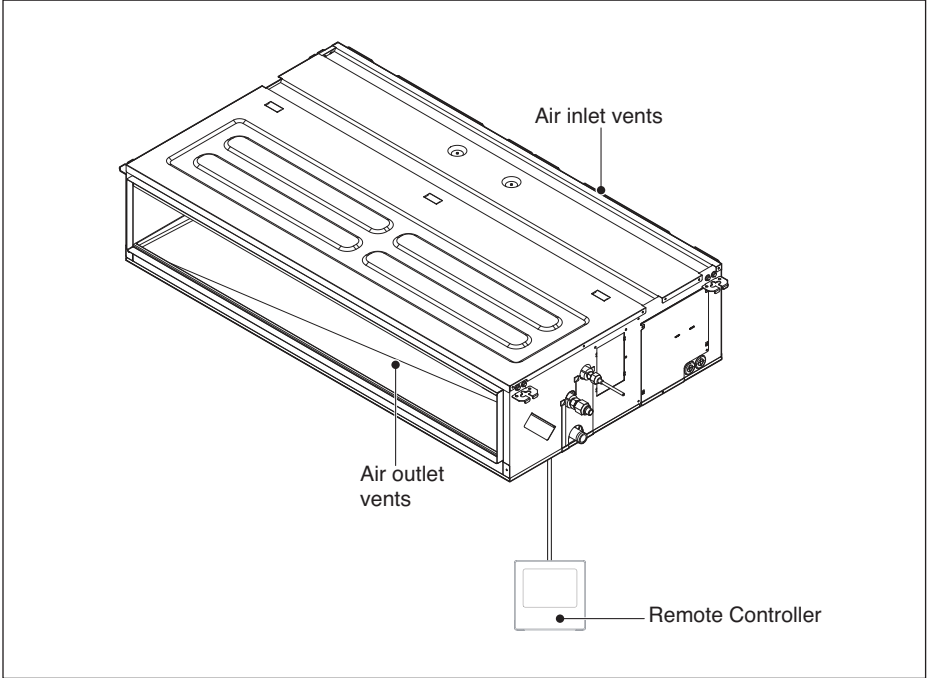

INSTALLATION OF INDOOR

Selection of the best location

- The place shall easily bear a load exceeding four times the indoor unit's weight.
- The place shall be able to inspect the unit as the figure.
- The place where the unit shall be leveled.
- The place shall allow easy water drainage.(Suitable dimension "H" is necessary to get a slope to drain as figure.)
- The place shall easily connect with the outdoor unit.
- The place where the unit is not affected by an electrical noise.
- The place where air circulation in the room will be good .
- There should not be any heat source or steam near the unit
- Confirm the positional relationship between the unit and suspension bolts.
- Thermal insulator the ceiling opening to clean the filter or service under the product.

Installation of Unit

Install the unit above the ceiling correctly.

CASE 1

Position of suspension Bolt

- Apply a joint-canvas between the unit and duct to absorb unnecessary vibration.
- Apply a filter Accessory at air return hole.

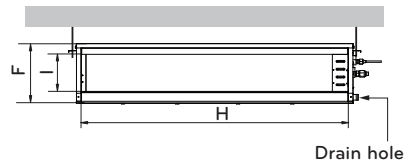
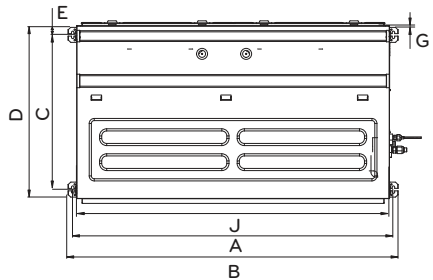

Top view
Unit: mm

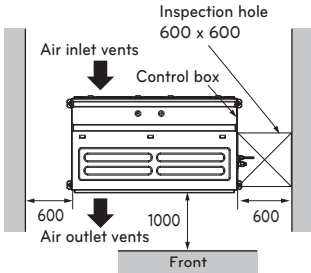

Front view
Unit: mm

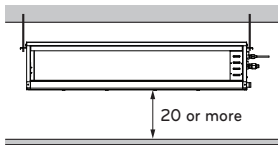

(Unit:mm)

Dimension	A	B	C	D	E	F	G	H	I	J
Capacity (kBtu/h)										
18k/24k/30k	933.4	971.6	619.2	691	30	270	15.2	858	201.4	900
36k/48k/54k/60k	1283.4	1321.6	619.2	691	30	360	15.2	1208	201.4	1250

CASE 2

- Install the unit leaning to a drainage hole side as a figure for easy water drainage.

Position of console Bolt

- A place where the unit will be leveled and that can support the weight of the unit.
- A place where the unit can withstand its vibration.
- A place where service can be easily performed.

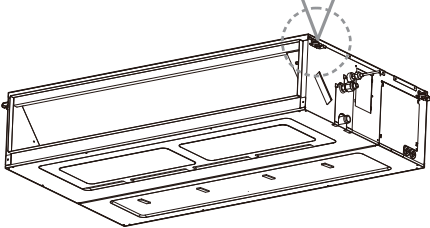
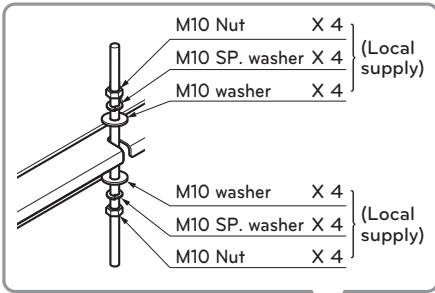

CAUTION

Tighten the nut and bolt to prevent unit falling.

- Select and mark the position for fixing bolts.
- Drill the hole for set anchor on the face of ceiling.

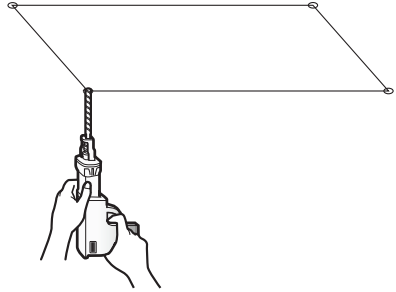

- Insert the set anchor and washer onto the suspension bolts for locking the suspension bolts on the ceiling.
- Mount the suspension bolts to the set anchor firmly.
- Secure the installation plates onto the suspension bolts (adjust level roughly) using nuts, washers and spring washers.

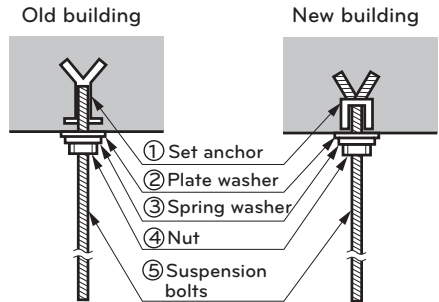

CAUTION

- Install declination of the indoor unit is very important for the drain of the duct type air conditioner.
- Minimum thickness of the insulation for the connecting pipe shall be 5 mm.

Front of view

- The unit must be declined to the drain hose connected when finished installation.

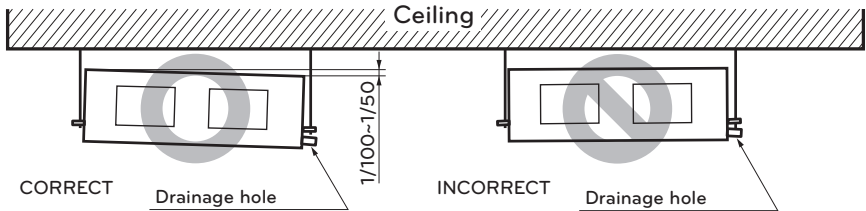

Caution for gradient of unit and drain piping

Lay the drain hose with a downward inclination so water will drain out.

- Always lay the drain with downward inclination (1/100 to 1/50). Prevent any upward flow or reverse flow in any part.
- 10 mm or thicker formed thermal insulator shall always be provided for the drain pipe.

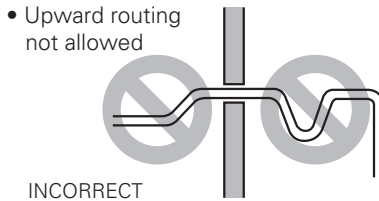
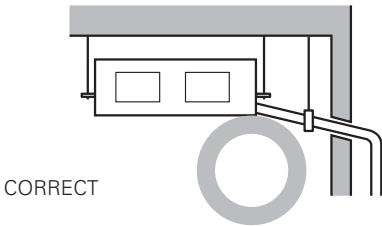
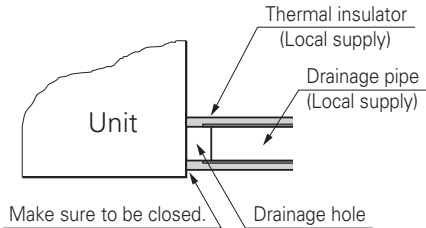

- Upward routing not allowed

Applied U-Trap Dimension

- A ≥ 70 mm
- B ≥ 2C
- C ≥ 2 × SP
- SP = External Pressure (mmAq)
- Ex) External Pressure = 10 mmAq
- A ≥ 70 mm
- B ≥ 40 mm
- C ≥ 20 mm

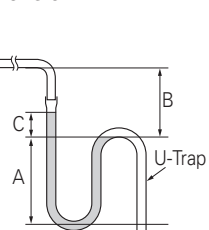

- Install the P-Trap (or U-Trap) to prevent a water leakage caused by the blocking of intake air filter.

Indoor Unit Drain Piping

- Drain piping must have down-slope (1/50 to 1/100): be sure not to provide up-and-down slope to prevent reversal flow.
- During drain piping connection, be careful not to exert extra force on the drain port on the indoor unit.
- The outside diameter of the drain connection on the indoor unit is 32 mm.

Piping material: Polyvinyl chloride pipe VP-25 and pipe fittings

- Be sure to execute thermal insulator on the drain piping.
- Install the drain raising pipes at a right angle to the indoor unit and no more than 300 mm from the unit.

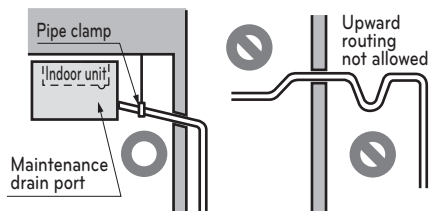

Thermal insulator material: Polyethylene foam with thickness more than 8 mm.

Drain test

- Connect the main drain pipe to the exterior and leave it provisionally until the test comes to an end.
- Feed water to the flexible drain hose and check the piping for leakage.
- When the test is complete, connect the flexible drain hose to the drain port on the indoor unit.

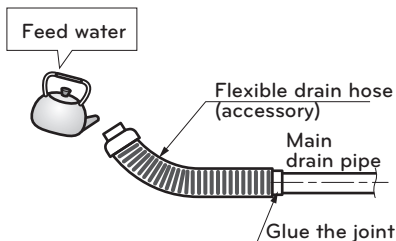

- 1 Remove the air filter.

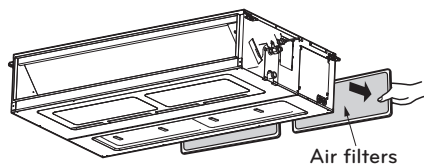

- 2 Check the drain.
 - Spray one or two glasses of water upon the evaporator.
 - Ensure that water flows drain hose of indoor unit without any leakage.

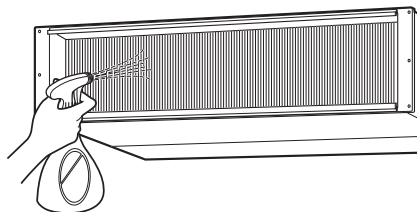

Thermal insulator

- 1 Use the thermal insulator material for the refrigerant piping which has an excellent heat-resistance (over 120 °C).
- 2 If this air conditioner is operated for a long time in high humid atmosphere (dew point temperature: more than 23 °C), water drops are liable to fall. In this case, add thermal insulator material according to the following procedure:
 - Thermal insulation material to be prepared... Adiabatic glass wool with thickness 10 to 20 mm.
 - Stick glass wool on all air conditioners that are located in ceiling atmosphere.

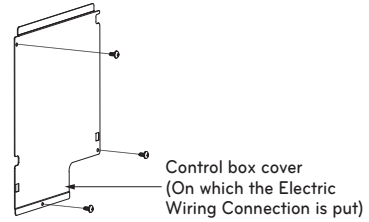
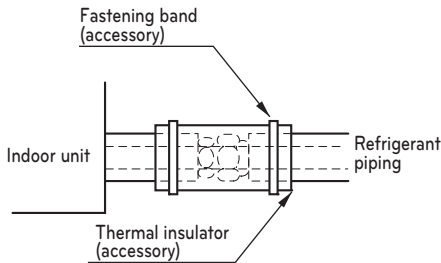

A view

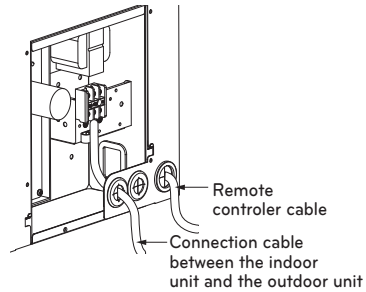

Wiring Connection

- Open the control box cover and connect the Remote controller cable and Indoor power wires.
- Remove the control box cover for electrical connection between the indoor and outdoor unit. (Remove screws ①.)
- Use the cord clumper to fix the cable.

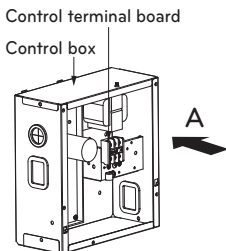

CAUTION

- The connecting cable connected to the indoor and outdoor unit should be complied with the following specifications (Rubber insulation, type H05RN-F approved by HAR or SAA).

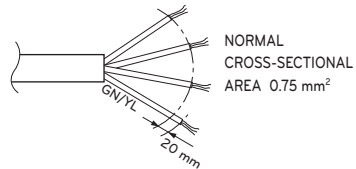

- If the supply cable is damaged, it must be replaced by a special cable or assembly available from the manufacturer of its service agent. When the connection line between the indoor unit and outdoor unit and outdoor unit is over 40 m, connect the telecommunication line and power line separately.
- Pipes and wires should be purchased separately for installation of the product.

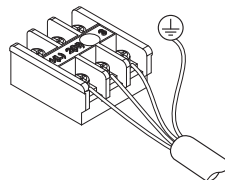

⚠ CAUTION

Precautions when laying power wiring

Use round pressure terminals for connections to the power terminal block.

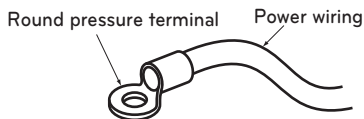

When none are available, follow the instructions below.

- Do not connect wiring of different thicknesses to the power terminal block. (Slack in the power wiring may cause abnormal heat.)
- When connecting wiring which is the same thickness, do as shown in the figure below.

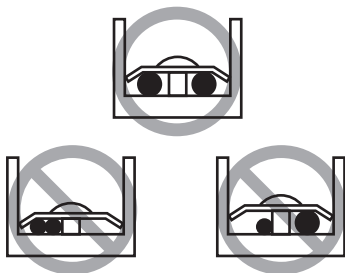

- For wiring, use the designated power wire and connect firmly, then secure to prevent outside pressure being exerted on the terminal block.
- Use an appropriate screwdriver for tightening the terminal screws. A screwdriver with a small head will strip the head and make proper tightening impossible.
- Over-tightening the terminal screws may break them.

Flaring Work

Main cause for gas leakage is due to defect of flaring work. Carry out correct flaring work in the following procedure.

Cut the pipes and the cable

- 1 Use the piping kit accessory or the pipes purchased locally.
- 2 Measure the distance between the indoor and the outdoor unit.
- 3 Cut the pipes a little longer than measured distance.
- 4 Cut the cable 1.5m longer than the pipe length.

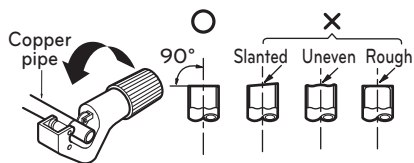

Burrs removal

1. Completely remove all burrs from the cut cross section of pipe/tube.
2. While removing burrs put the end of the copper tube/pipe in a downward direction while removing burrs location is also changed in order to avoid dropping burrs into the tubing.

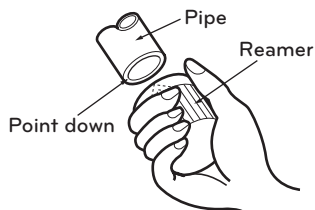

⚠ CAUTION

Copper in contact with refrigerants shall be oxygen-free or de-oxygenated, for example Cu-DHP as specified in EN 12735-1 and EN 12735-2

Putting nut on

- Remove flare nuts attached to indoor and outdoor unit, then put them on pipe/tube having completed burr removal. (not possible to put them on after finishing flare work)

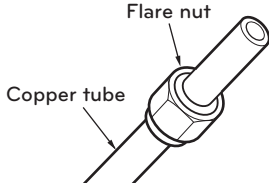

Flaring work

- 1 Firmly hold copper pipe in a bar with the dimension shown in below table table below.
- 2 Carry out flaring work with the flaring tool.

Pipe diameter Inch (mm)	A Inch (mm)	
	Wing nut type	Clutch type
Ø1/4 (Ø6.35)	0.04~0.05 (1.1~1.3)	0~0.02 (0~0.5)
Ø3/8 (Ø9.52)	0.06~0.07 (1.5~1.7)	
Ø1/2 (Ø12.7)	0.06~0.07 (1.6~1.8)	
Ø5/8 (Ø15.88)	0.06~0.07 (1.6~1.8)	
Ø3/4 (Ø19.05)	0.07~0.08 (1.9~2.1)	

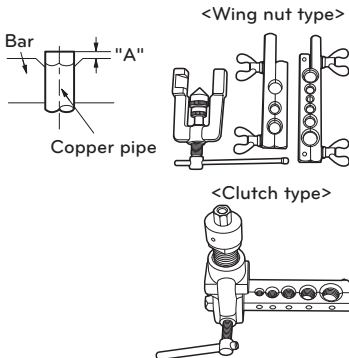

CAUTION

- The installation of pipe-work shall be kept to a minimum
- Flared joint shall be restricted to use with annealed pipe only, and to pipe sizes not exceeding a diameter of 20 mm outside diameter.

Check

- 1 Compare the flared work with the figure by.
- 2 If a flared section is defective, cut it off and do flaring work again.

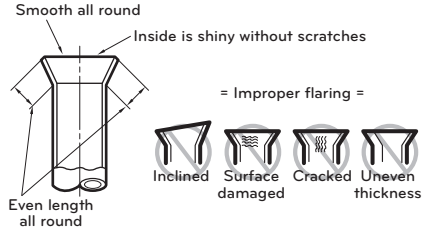

Connecting the installation pipe and drain hose to the indoor unit.

- 1 Align the center of the pipes and sufficiently tighten the flare nut by hand

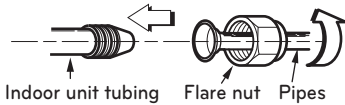

- 2 Tighten the flare nut with a wrench

Outside diameter		Torque
mm	inch	kgf·m
Ø6.35	1/4	1.8~2.5
Ø9.52	3/8	3.4~4.2
Ø12.7	1/2	5.5~6.5
Ø15.88	5/8	6.3~8.2
Ø19.05	3/4	9.9~12.1

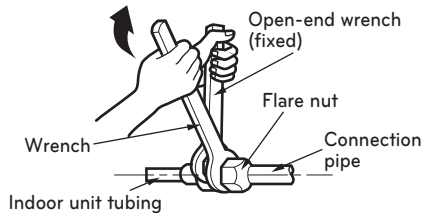

CAUTION

- When mechanical connectors are reused indoors, sealing parts shall be renewed.
- When flared joints are reused indoors, the flare part shall be re-fabricated.

- 3 When needed to extend the drain hose of indoor unit, assembly the drain pipe as shown on the drawing

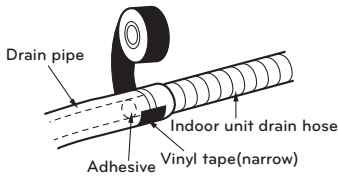

Wrap the insulation material around the connecting portion.

- 1 Overlap the connection pipe insulation material and the indoor unit pipe insulation material. Bind them together with vinyl tape so that there may be no gap.

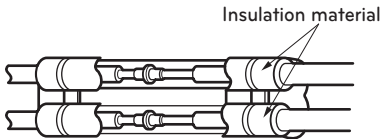

- 2 Set the tubing cutting line upward. Wrap the area which accommodates the rear piping housing section with vinyl tape.

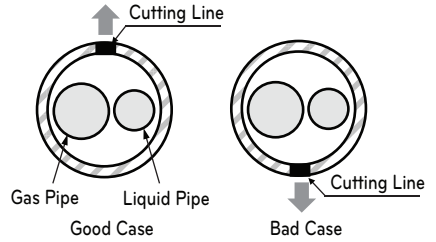

* Tubing cutting line have to be upward.

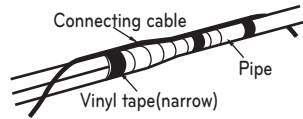

- 3 Bundle the piping and drain hose together by wrapping them with vinyl tape sufficient enough to cover where they fit into the rear piping housing section.

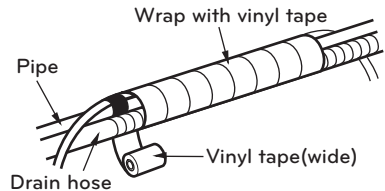

INSTALLATION INSTRUCTION

- 1 Please fix tightly using provided screw after placing remote controller setup board on the place where you like to setup.
 - Please set it up not to bend because poor setup could take place if setup board bends.
 - Please set up remote controller board fit to the reclamation box if there is a reclamation box.

- 2 Can set up wired remote controller cable into three directions.
 - Set up direction: the surface of wall reclamation, upper, right
 - If setting up remote controller cable into upper and right side, please set up after removing remote controller cable guide groove.

* Remove guide groove with long nose.

- ① Reclamation to the surface of the wall
- ② Upper part guide groove
- ③ Right part guide groove

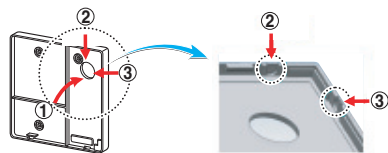
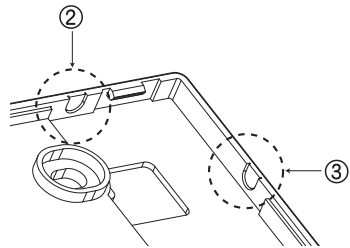
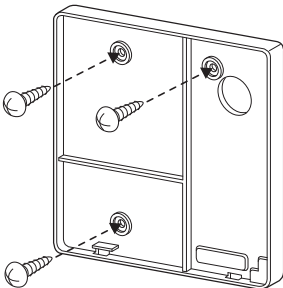
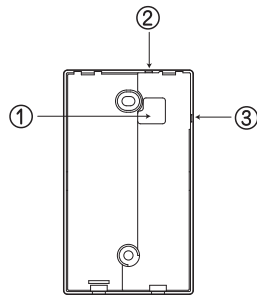
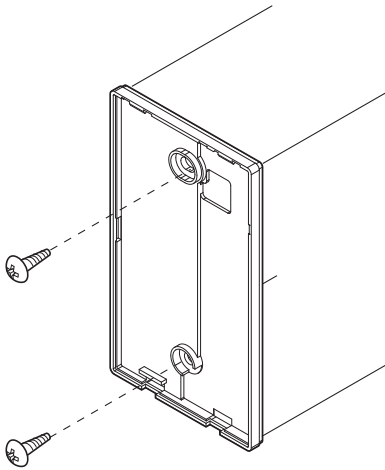

<Wire guide grooves>

- 3 Please fix remote controller upper part into the backplate attached to the surface of the wall, as the picture below, and then, connect with backplate by pressing lower part.
- Please make sure to leave no gaps on the top, bottom, left or right sides between the remote controller and backplate.
 - Before assembly with the backplate, arrange the Cable not to interfere with circuit parts.

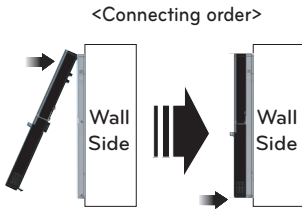

Remove remote controller by inserting a screwdriver into the lower separating holes and twisting to release the controller from backplate.

- There are two separating holes. Please individually separate one at a time.
- Please be careful not to damage the inside components when separating.

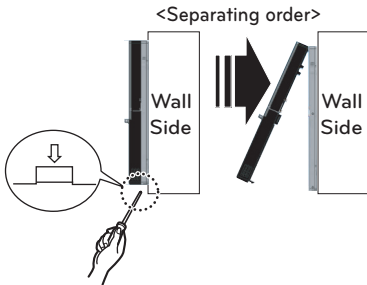

- 4 Please refer to the following directions when connecting the indoor unit and the wired remote controller together.

- Please connect the cables as shown in the figure below when connecting the plug type cable from the indoor unit's C/BOX and the housing type of the extension cable.

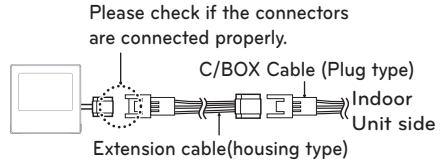

CAUTION

- Specification of LG supplied extension cable: AWG#22, 3 core shielded. (Model : PZCWRC1)
- * Apply enclosed noncombustible conduit(metal raceway) totally or use FT-6 rated cable or above level in case of local electric & building code that requires plenum (CMP) cable usage.

- When connecting Terminal Blocks of the indoor C/BOX and the wired remote controller with the extension cable, refer to the steps below.

- ① Remove the screw on the cable which is fastened to the wired remote controller's Terminal Block by loosening with a screw driver.
- ② Remove the housing of the provided 32 ft extension cable with a cutting nipper and peel it as shown in the figure below. (when purchasing the extension cable at the site directly, please peel it as shown in the figure below.)

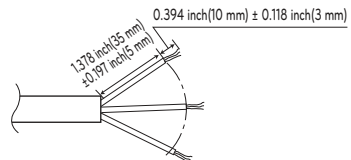

- ③ Make sure each wire is securely fastened under each screw terminal and the wires are not in contact with each other.
- ④ Please connect the Terminal blocks of indoor unit's C/BOX and wired remote controller by referring to the images and contents shown below.
 Connect the yellow(signal) part of the wired remote controller's terminal block and the 'YL' part of the indoor unit's terminal block.
 Connect the red(12 V) part of the wired remote controller's terminal block and the 'RD' part of the indoor unit's terminal block.
 Connect the black(GND) part of the wired remote controller's terminal block and the 'BK' part of the indoor unit's terminal block.

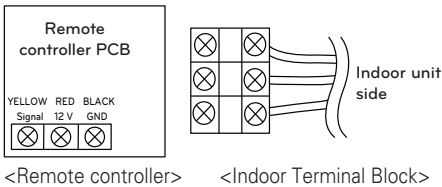

Remote controller PCB Terminal block Remark	Indoor Terminal block	Function
YELLOW	YL	Signal
RED	RD	12 V
BLACK	BK	GND

- * In case of loosened screws or insufficient contact between the terminal and the wire, remote controller may not function properly.
- * When the power is off on the remote controller, check the connection between the remote controller and Terminal Block.
- * Use an appropriate screwdriver for tightening the terminal screws. A screwdriver with a small head will strip the head and make proper tightening impossible.
- * Over-tightening the terminal screws may break wires and terminal block structure.

! CAUTION

- Installation work must be performed in accordance with the national wiring standards and local by authorized personnel only.
- Installations must comply with the applicable local/national or international standards.
- AWG#22, 3 core shielded is recommended when using the large hole in the center of the back plate.
- AWG#24, 3 core shielded is recommended when using the side or top knock-out of the back plate.

- 5 Please use an extension cable if the distance between the wired remote controller and the indoor unit is longer than 32 ft(10 m).

! CAUTION

- When installing the wired remote controller, do not bury it in the wall. (It can cause damage in the temperature sensor.)
- Do not install the cable to be 164 ft(50 m) or longer. (It can cause communication error.)

Remote controller installation

Since the room temperature sensor is in the remote controller, the remote controller box should be installed in a place away from direct sunlight, high humidity and direct supply of cold air to maintain proper space temperature. Install the remote controller about 5 ft(1.5 m) above the floor in an area with good air circulation at an average temperature.

Do not install the remote controller where it can be affected by:

- Drafts, or dead spots behind doors and in corners.
- Hot or cold air from ducts.
- Radiant heat from sun or appliances.
- Concealed pipes and chimneys.
- Uncontrolled areas such as an outside wall behind the remote controller.
- This remote controller is equipped with LCD. display. For proper display of the remote controller LCD's, the remote controller should be installed properly as shown in Fig.1.
(The standard height is 4~5 ft (1.2~1.5 m) from floor level.)

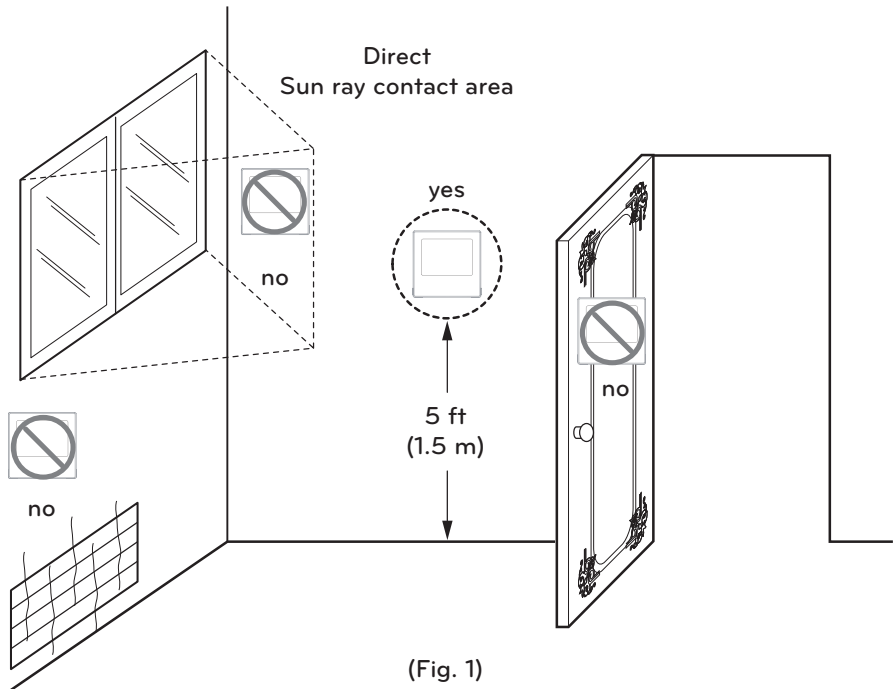

(Fig. 1)

Group control

- When installing more than 2 units of air conditioner to one wired remote controller, please connect as the right figure.
 - If it is not event communication indoor unit, set the unit as slave.
 - Check for event communication through the product manual.

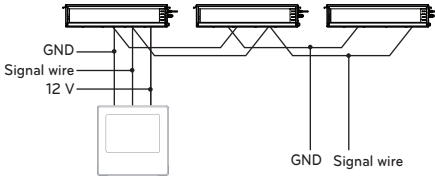

When controlling multiple indoor units with event communication function with one remote controller, you must change the master/slave setting from the indoor unit.

Indoor units, the master/slave configuration of the product after completion of indoor unit power 'OFF' and then 'ON' the power after 1 minutes elapsed sign up.

- For ceiling type cassette and duct product group, change the switch setting of the indoor PCB.



#3 switch OFF: Master
(Factory default setting)



#3 switch ON: Slave

- For wall-mount type and stand type product, change the master/slave setting with the wireless remote controller. (Refer to wireless remote controller manual for detail)

- * When installing 2 remote controllers to one indoor unit with event communication function, set the master/slave of the remote controller. (Refer to remote controller master/slave selection)

When controlling the group, some functions excluding basic operation setting, fan level Min/Mid/Max, remote controller lock setting and time setting may be limited.

- When installing more than 2 wired remote controllers to one air conditioner, please connect as the right picture.

- When installing more than 2 units of wired remote controller to one air conditioner, set one wired remote controller as master and the others all as slaves, as shown in the right picture.
- You cannot control the group as shown in the right for some products.
- Refer to the product manual for more detail.

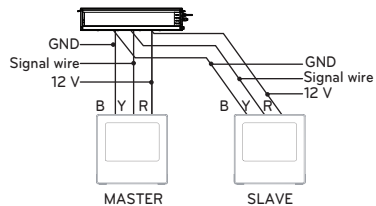

- When controlling in groups, set the master/slave of the remote controller. Refer to Installer setting section on how to set master/slave for more detail.

Installer Setting - How to enter installer setting mode

CAUTION

Installer setting mode is to set the detail function of the remote controller. If the installer setting mode is not set correctly, it can cause problems to the product, user injury or property damage. This must be set by a certificated installer, and any installation or change that is carried out by a non-certificated person should be responsible for the results. In this case, free service cannot be provided.

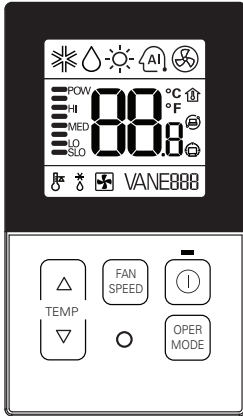

- 1 If you want to set installer setting mode, Press the Temperature up button and the oper mode button same time for five seconds.
- 2 When you enter the setting mode Initially. Function code is displayed on the LCD screen.

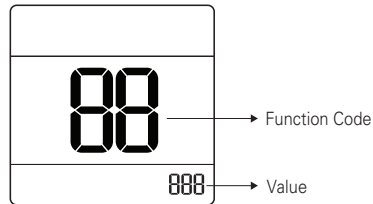

<Installer Setting Code Table> General air-conditioner product

No.	Function	Code	Value
1	Test Run	01	01:Set
2	Address Setting	02	00~FF : Address
3	E.S.P. Value	03	<ESP Step> <ESP Value><Example> 01:VeryLow 0 ~ 255 02:Low 03:Med 04:High 05:Very High <div style="text-align: right; margin-top: 10px;"> 0301 000 <small>Function Code ESP step ESP value</small> </div>
4	Thermistor	04	01:Remo 02:Indoor 03:2TH
5	Ceiling Height	05	01:Med 02:Low 03:High 04:Very High
6	Static Pressure	06	01:V-H 02:F-H 03:V-L 04:F-L
7	Master Setting	07	00:Slave 01:Master
8	Celsius Fahrenheit Switching	12	00:Celsius 01:Fahrenheit (Optimized only for U.S.A)
9	Static Pressure Step	32	00: use static pressure (code 06) set value 01~ 11: static pressure step (code 32) set value



* Some contents may not be displayed depending on the product function

Installer Setting - Test Run Mode

After installing the product, you must run a Test Run mode.

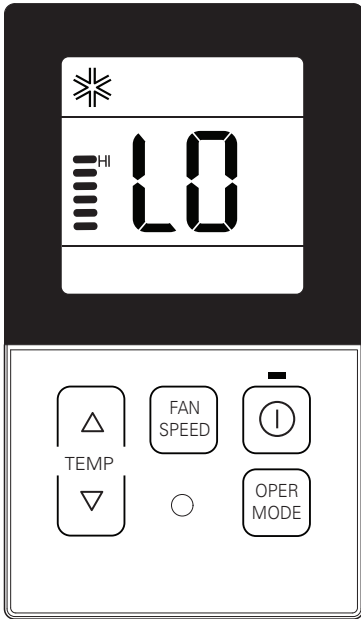
For details related to this operation, refer to the product manual.





1 When pressing the  button and  button simultaneously for more than 3 seconds, the system will be entered into the installer setting mode.

- After entering into the installer setting mode, select the test run mode code value by pressing the  button.

* Test run mode code value : 01

2 When pressing the  button, the test operation mode will be performed, and it is displayed as shown in the left figure.

3 When pressing the  button and  button simultaneously for more than 3 seconds after the setting has been completed, the setting mode will be released.

- If there isn't any button input for more than 25 seconds, the installer setting mode will also be released.

4 When approx. 18 minutes are elapsed after starting of the test oper-mode, the system will be stopped automatically and converted to the standby state.

- If any button is inputted during the test run mode, the test run mode will be forced to be released.

What is the test run mode?

- This means the operation of the product under the cooling, strong wind, and Comp on state without performing room temperature control in order to confirm the installed state during the product installation.

Installer Setting - Setting Address of Central Control

It's the function to use for connecting central control.

Please refer to central controller manual for the details

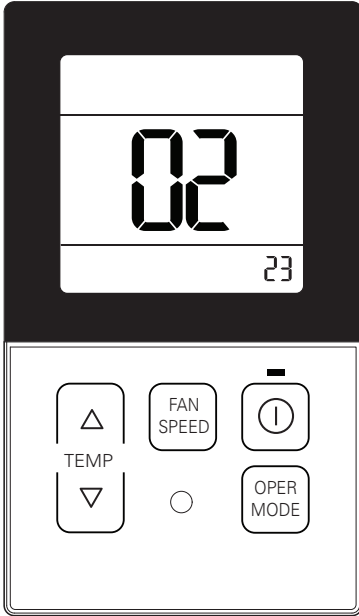

- 1 When pressing the button and button simultaneously for more than 3 seconds, the system will be entered into the installer setting mode.
 - After entering into the installer setting mode, select the central control address setting code value by pressing the button.
 - * Setting address of central control code value : 02

- 2 Set up the group number and indoor unit with the temperature adjustment(,) buttons.

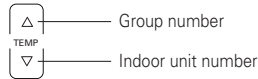

For example, when setting as
 [Group number=2 Indoor number=3]
 it will be displayed as shown in the left figure.

- 3 When pressing the button, the system will be set up with the address value which has been established at present.

- 4 When pressing the button and button simultaneously for more than 3 seconds after the setting has been completed, the setting mode will be released.
 - If there isn't any button input for more than 25 seconds, the installer setting mode will also be released.

- If you connect the indoor unit to the central controller, you should set the network address of the indoor unit so that the central controller could recognize it.
- The center-control address is composed of the group number and the indoor-unit number.

NOTE

The remote controller displays 'HL' if central controller has locked the remote controller .









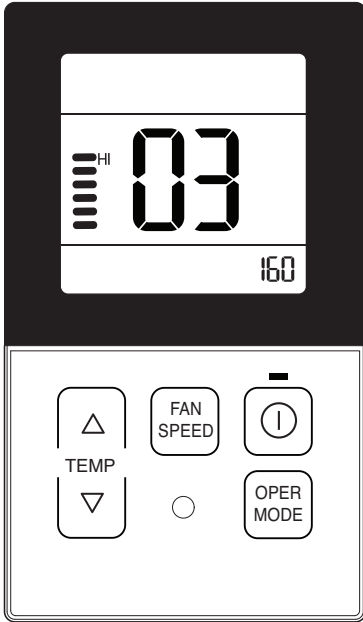

In the case when the lock is set up at the central controller, 'HL' will be indicated on the display window of the wired remote controller and the indoor unit will not be controlled by the remote controller.

Installer Setting - E.S.P.

This is the function that decides the strength of the wind for each wind level and because this function is to make the installation easier.

- If you set ESP incorrectly, the air conditioner may malfunction.
- This setting must be carried out by a certificated-technician.



- 1 When pressing the  button and  button simultaneously for more than 3 seconds, the system will be entered into the installer setting mode.
 - After entering into the installer setting mode, select the E.S.P code value by pressing the  button.
 - * E.S.P code value : 03
- 2 Select the desired air flow rate with the  button. Whenever pressing the  button, [Lo→Med→Hi] will be indicated.
- 3 Select the desired air flow rate value with the temperature up() , down() button.
 - * E.S.P value range : 0~255
 - E.S.P value will be indicated at the upper right section of the display window.
- 4 When pressing the  button, currently established E.S.P value will be set up.
- 5 When pressing the  button and  button simultaneously for more than 3 seconds after the setting has been completed, the setting mode will be released.
 - If there isn't any button input for more than 25 seconds, the installer setting mode will also be released.

- Precaution shall be taken not to alter the E.S.P value corresponded to each air flow section.
- E.S.P value can be varied according to the products.
- In the case of going to the next air flow rate stage by pressing the fan-speed button during the setup of the E.S.P value, the E.S.P value of previous air flow rate will be maintained by remembering the E.S.P value prior to the shift.

Installer Setting - Thermistor

This is the function to select the temperature sensor to judge the room temperature.

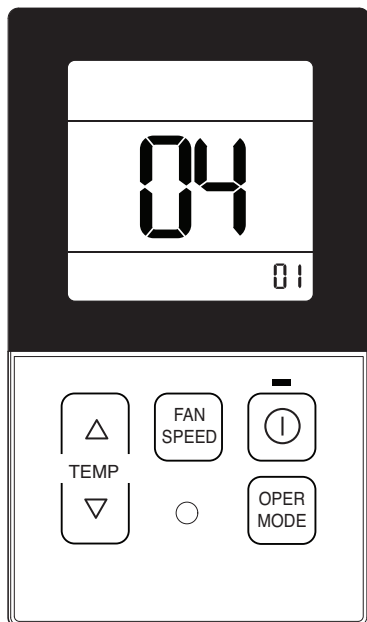

- 1 When pressing the button and button simultaneously for more than 3 seconds, the system will be entered into the installer setting mode.
 - After entering into the installer setting mode, select the thermistor sensor setting code value by pressing the .
 - * Thermistor sensor selection code value : 04

- 2 Select the desired setting value with the temperature up() , down() button.

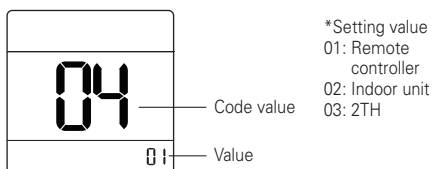

- 3 When pressing the button, currently established thermistor sensor location will be set up.

- 4 When pressing the button and button simultaneously for more than 3 seconds after the setting has been completed, the setting mode will be released.
 - If there isn't any button input for more than 25 seconds, the installer setting mode will also be released.

* As the characteristic of the '2TH' function can be different in accordance with the products, refer to the product instruction manual for its detail.

Installer Setting - Ceiling Height Selection

This function is to adjust FAN Airflow rate according to ceiling height (For ceiling type product)

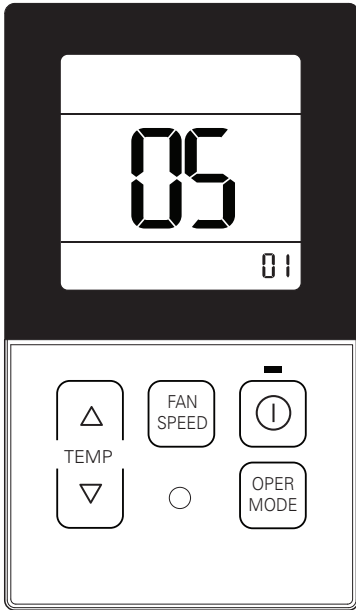

- As the ceiling height setting standard can be different in accordance with the products, refer to the product instruction manual for its detail.

- 1** When pressing the button and button simultaneously for more than 3 seconds, the system will be entered into the installer setting mode.

 - After entering into the installer setting mode, select the ceiling height setting code value by pressing the button.
 - * Ceiling height setting code value : 05
- 2** Select the desired setting value with the temperature up(), down() button.

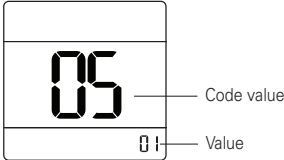

*Setting value
01: Low
02: Standard
03: High
04: Very high
- 3** When pressing the button, currently established ceiling height value will be set up.
- 4** When pressing the button and button simultaneously for more than 3 seconds after the setting has been completed, the setting mode will be released.

 - If there isn't any button input for more than 25 seconds, the installer setting mode will also be released.

<Ceiling Height Selection Table>

Ceiling Height Level		Description
01	Low	Decrease the indoor airflow rate 1 step from standard level
02	Standard	Set the indoor airflow rate as standard level
03	High	Increase indoor airflow rate 1 step from standard level
04	Very high	Increase indoor airflow rate 2 steps from standard level

- Ceiling height setting is available only for some products.
- Ceiling height of 'Very high' function may not exist depending on the indoor unit.
- Refer to the product manual for more details.

Installer Setting - Static Pressure Setting

This function is applied to only duct type. Setting this in other cases will cause malfunction.

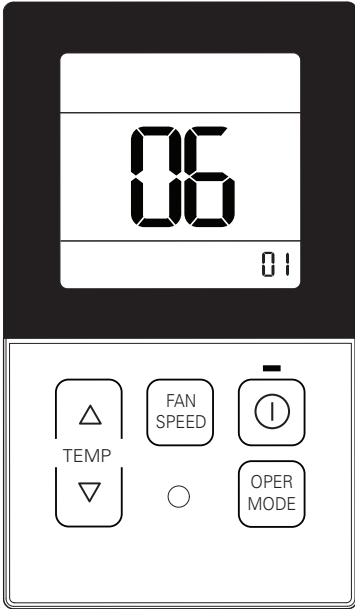

1 When pressing the button and button simultaneously for more than 3 seconds, the system will be entered into the installer setting mode.

- After entering into the installer setting mode, select the static pressure setting code value by pressing the .

* Static pressure setting code value : 06

2 Select the desired setting value with the temperature up(), down() button.



*Setting value
01:V-H
02:F-H
03:V-L
04:F-L

3 When pressing button, currently established static pressure value will be set up.

4 When pressing the button and button simultaneously for more than 3 seconds after the setting has been completed, the setting mode will be released.

- If there isn't any button input for more than 25 seconds, the installer setting mode will also be released.

<Static Pressure Setting Table>

Pressure selection		Function	
		Zone state	ESP standard value
01	V-H	Variable	High
02	F-H	Fixed	High
03	V-L	Variable	Low
04	F-L	Fixed	Low

Installer Setting - Remote Controller Master/Slave Setup

It is a function for settings in group control, or 2-remote controller control.

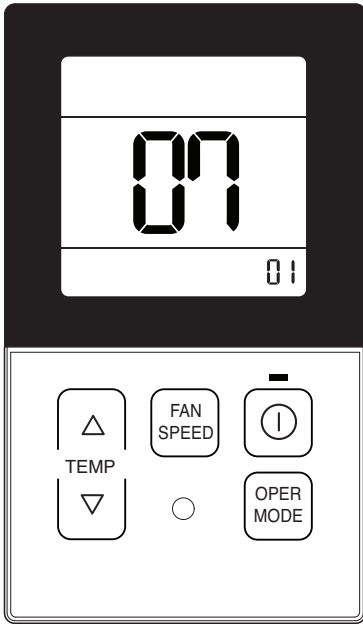

- 1 When pressing the button and button simultaneously for more than 3 seconds, the system will be entered into the installer setting mode.
 - After entering into the installer setting mode, select the ceiling height setting code value by pressing the oper-mode button.
 - * Remote controller master/slave setting code value : 07

- 2 Select the desired setting value with the temperature up(), down() button.

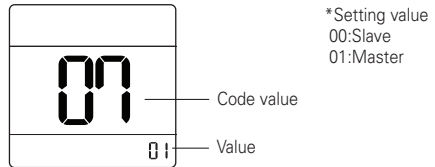

- 3 When pressing the button, currently established static pressure value will be set up.

- 4 When pressing the button and button simultaneously for more than 3 seconds after the setting has been completed, the setting mode will be released.
 - If there isn't any button input for more than 25 seconds, the installer setting mode will also be released.

Remote controller	Function
Master	Indoor unit operates based on master remote controller at group control. (Master is set when delivering from the warehouse.)
Slave	Setup all remote controllers except one master remote controller to slave at group control

* Refer to the 'group control' part for details

- When controlling in groups, basic operation settings, airflow strength weak/medium/strong, lock setting of the remote controller, time settings, and other functions may be restricted.

Installer Setting - Auto ESP

This function automatically sets the rotation speed of the fans corresponding to each step of rated airflow for easy installation.

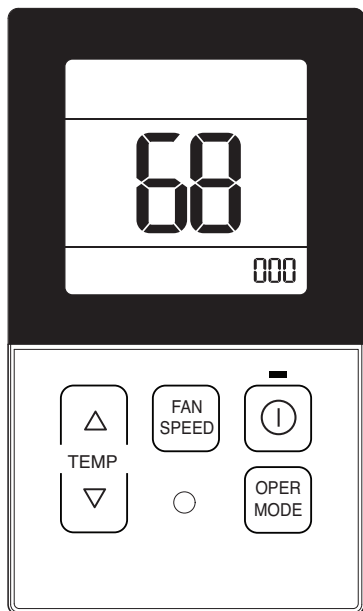

1 When pressing the button and button simultaneously for more than 3 seconds, the system will be entered into the installer setting mode.

- If button is pressed repeatedly, it is moved to Auto ESP setting menu as the picture below.

* Code value : 68

2 Set the auto ESP mode using the Temperature button and set the manual step using the Fan speed button.

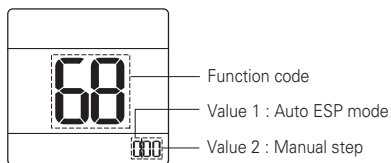

3 Press button to save the setting.

4 When pressing the button and button simultaneously for more than 3 seconds after the setting has been completed, the setting mode will be released.

- If there isn't any button input for more than 25 seconds, the installer setting mode will also be released.

- * The voltage can be set by setting the Auto ESP Mode to 'Manual (02)'. Move to the manual step settings using 'Fanspeed' button.
- * While 'Auto ESP' is being set, the display on the wired remote control changes as shown below, and the wired remote control cannot be operated.
- * Once the set-up is complete, you can enter installer setup (68) to check whether the set-up has succeeded or failed. (03: Success, 04: Failure)

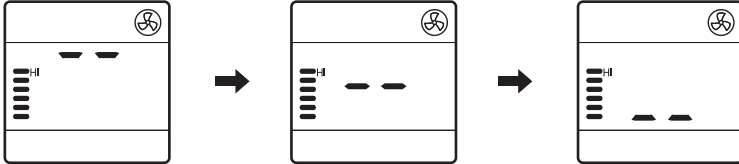

Value 1 (Auto ESP mode)	Value 2 (Manual Step)	Description (Voltage setting)
00 (Not use)	-	-
01 (Auto)	-	-
02 (Manual)	0	190 V
	1	200 V
	2	210 V
	3	220 V
	4	230 V
	5	240 V
	6	250 V
	7	260 V
	8	270 V
03	-	Cannot be set, only monitoring is possible. If the value1 is 03, setting is successful.
04	-	Cannot be set, only monitoring is possible. If the value1 is 04, setting has failed.

! NOTE

If this function is incorrectly set especially, in case of mismatching the voltage, the air conditioner may malfunction.

This function must be set by the installation specialist that holds an installation license. (please check the product type)

! NOTE

- If the heat exchanger is not dry, please set the device to operate in air circulation mode for 15 minutes.
- The air filter must be properly attached to the suction side of the product.
- Adjust the dampers so that each air inlet and outlet exhaust the required air.
- Please do not use the set auto air flow function when using various booster fans (outdoor air treatment device or ERV through ducts).
- Please reinitiate the set auto air flow function if the duct shape has changed since its initial installation.
- When setting the voltage manually, the set air flow will differ from the actual air flow if the set voltage is different from the actual voltage.
- When setting voltage manually, measure the actual voltage and select the set voltage on the remote control.
- Failure to follow the above method may cause the actual air flow to differ from the rated air flow.

OPTIONAL OPERATION

Installer Setting - Test Run Mode

After installing the product, you must run a Test Run mode.

For details related to this operation, refer to the product manual.

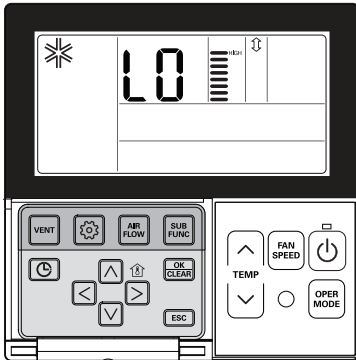

- Press and hold button for more than 3 seconds to enter the installer settings mode.

 - If pressing only once briefly, it will enter the user settings mode. Make sure to press and hold for more than 3 seconds.
 - For the wall-mount product, cancel the wind direction left/right.

- The set value '01' will blink in the lower part of display window.

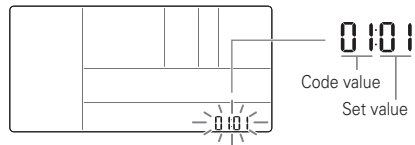

Select the test run mode using button.

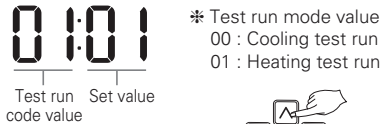

- Press button to start test run.

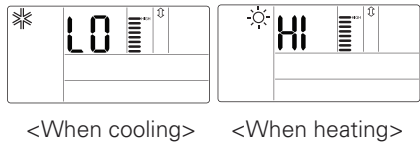

- During a test run, press the button below to cancel the test run.

 - Operation selection, temperature up/down, fan speed, Airflow, run/stop button

Installer Setting - E.S.P.

This is the function that decides the strength of the wind for each wind level and because this function is to make the installation easier.

- If you set ESP incorrectly, the air conditioner may malfunction.
- This setting must be carried out by a certificated-technician.

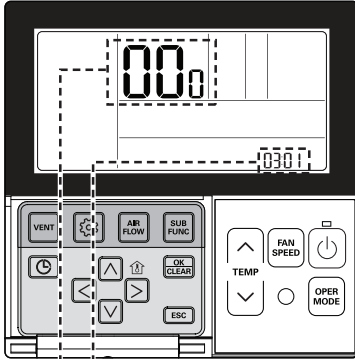

Function code,
ESP code

ESP value

- 1 Press and hold button for more than 3 seconds to enter the installer settings mode.
- If pressing only once briefly, it will enter the user settings mode.
Make sure to press and hold for more than 3 seconds.



- 2 Once entered the ESP setting mode using button, it displays as below.

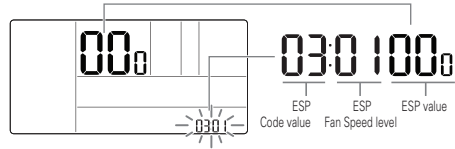

- 3 Select the level of ESP Fan Speed using button. There are 5 levels in the fan speed, SLOW → LOW → MED → HIGH → POW.

030 1
ESP level : 01~05



ESP level	Fan Speed
01	SLOW
02	LOW
03	MED
04	HIGH
05	POW.

* The ESP set value can be programmed 0~225.

- 4 Move to the ESP value settings using button.
The ESP value numbers will blink.
(It is set 000 by default.)

030 100



- 5 Set the ESP value using button.
(The ESP value can be set from 1 up to 255, and 1 is the smallest value and 255 is the largest value.)

00 → 225





Installer Setting - Thermistor

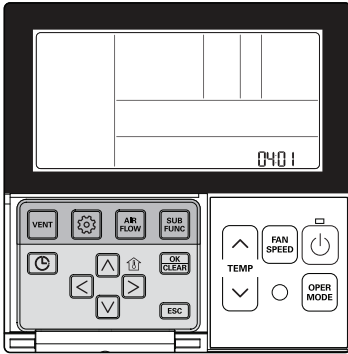

This is the function to select the temperature sensor to judge the room temperature.



- 1** Press and hold  button for more than 3 seconds to enter the installer settings mode.

- If pressing only once briefly, it will enter the user settings mode. Make sure to press and hold for more than 3 seconds.

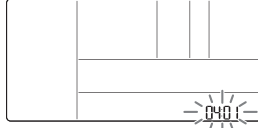
- 2** Move to the Selection of Indoor Temperature Sensor (Thermistor) in the menu using  button and then, it displays as below.



- 3** Select the location of indoor temperature sensor (Thermistor) using   button.

04.01



Code value for
Room temperature
sensor (Thermistor)

|

Set value

* Set value for sensor location
01 : Remote control
02 : Indoor unit
03 : 2TH
- 4** Press  button to save the setting.



- 5** Press  button to exit.

 - * If no button is selected for about 25 seconds after setup, it exits the setup mode automatically.
 - * If the  button is not selected before you exit, the changes will not apply.

<Thermistor Table>

Temperature sensor selection		Function	
01	Remote controller	Operation in remote controller temperature sensor	
02	Indoor unit	Operation in indoor unit temperature sensor	
03	2TH	Cooling	Operation of higher temperature by comparing indoor unit's and wired remote controller's temperature. (There are products that operate at a lower temperature.)
		Heating	Operation of lower temperature by comparing indoor unit's and wired remote controller's temperature.

* The function of 2TH has different operation characteristics according to the product.

Installer Setting - Group Setting

It is a function for settings in group control, or 2-remote controller control.)

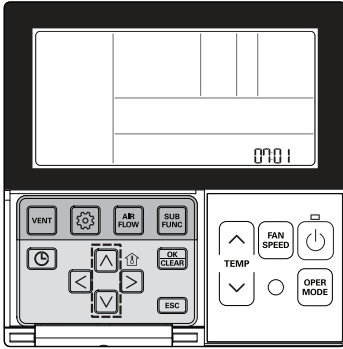

- 1** Press and hold button for more than 3 seconds to enter the installer settings mode.
- If pressing only once briefly, it will enter the user settings mode.
Make sure to press and hold for more than 3 seconds.

- 2** Move to the Master/slave selection in the menu using button and then it displays as below.

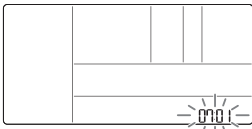

- 3** Select the remote control master/slave using button.

07:01

Code value for remote control master/slave

Set value

* Set value for remote control
00 : Slave
01 : Master

- 4** Press button to save the setting.

- 5** Press button to exit.
* If no button is selected for about 25 seconds after setup, it exits the setup mode automatically.
* If the button is not selected before you exit, the changes will not apply.

Remote controller	Function
Master	Indoor unit operates based on master remote controller at group control. (Master is set when delivering from the warehouse.)
Slave	Setup all remote controllers except one master remote controller to slave at group control

* Refer to the 'group control' part for details

NOTE



Some functions may not be available during a group control except basic operation settings, fan speed low/med/high, remote control lock setting, time setting.

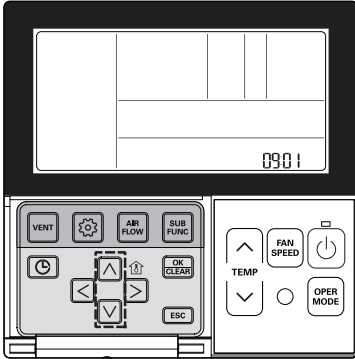

Installer Setting - Dry Contact Mode Setting

Dry contact function is the function that is possible to use only when dry contact equipment is separately purchased/setup.



- 1** Press and hold  button for more than 3 seconds to enter the installer settings mode.
 - If pressing only once briefly, it will enter the user settings mode.
 Make sure to press and hold for more than 3 seconds.

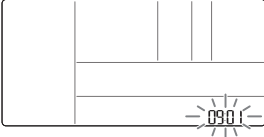

- 2** Move to the Dry Contact Mode Settings in the menu using  button and then it displays as below.





- 3** Select the Dry Contact Mode using   button.



Code value for dry contact Set value



* Set value for dry contact
 00 : Manual
 01 : Auto
- 4** Press  button to save the setting.



- 5** Press  button to exit.
 * If no button is selected for about 25 seconds after setup, it exits the setup mode automatically.
 * If the  button is not selected before you exit, the changes will not apply.

! NOTE

What is Dry Contact?

Like hotel card key and body perception sensor, it is the signal of the point of contact when using air-conditioner by interlocking.

- Please refer to dry contact manual for more details.

Installer Setting - Static Pressure Setting

This function is applied to only duct type. Setting this in other cases will cause malfunction.

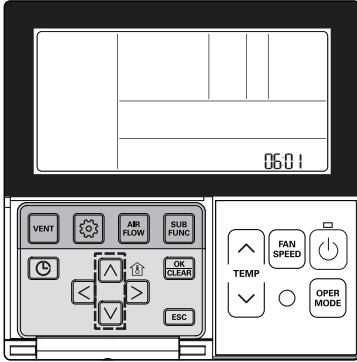

- 1** Press and hold button for more than 3 seconds to enter the installer settings mode.

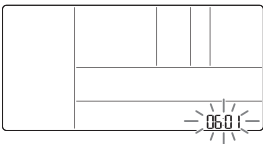

- If pressing only once briefly, it will enter the user settings mode.
Make sure to press and hold for more than 3 seconds.

- 2** Move to the Master/slave selection in the menu using button and then it displays as below.

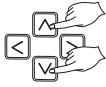
- 3** Select the remote control master/slave using button.

* Set value for static pressure
01 : V-H
02 : F-H
03 : V-L
04 : F-L
- 4** Press button to save the setting.



- 5** Press button to exit.

* If no button is selected for about 25 seconds after setup, it exits the setup mode automatically.

* If the button is not selected before you exit, the changes will not apply.

<Static Pressure Setting Table>

Pressure selection		Function	
		Zone state	ESP standard value
01	V-H	Variable	High
02	F-H	Fixed	High
03	V-L	Variable	Low
04	F-L	Fixed	Low

[Table. 1]

Capacity (kBtu/h)	Step	CMM	Static Pressure[mmAq(Pa)]										
			2(20)	2.5(25)	3(29)	4(39)	6(59)	8(78)	10(98)	12(118)	13(127)	14(137)	15(147)
			Setting Value										
			1step	2step	3step	4step	5step	6step	7step	8step	9step	10step	11step
18	HIGH	16.5	85	87	90	94	103	110	118	125	128	131	134
	MID	14.5	76	77	85	91	97	107	114	121	125	128	131
	LOW	13	73	74	77	88	93	103	111	117	120	125	128
24(27)	HIGH	18	90	92	95	99	108	115	122	129	132	135	138
	MID	16.5	85	87	90	94	103	111	118	125	128	131	134
	LOW	14.5	76	77	85	89	97	106	114	121	124	127	130

Capacity (kBtu/h)	Step	CMM	Static Pressure[mmAq(Pa)]										
			2.5(25)	4(39)	5(49)	6(59)	7(78)	8(78)	9(88)	10(98)	11(108)	13(127)	15(147)
			Setting Value										
			1step	2step	3step	4step	5step	6step	7step	8step	9step	10step	11step
30	HIGH	22	110	117	121	124	127	130	133	136	137	138	140
	MID	20	102	110	114	118	121	125	127	130	133	134	136
	LOW	18	96	102	107	110	114	118	122	125	127	130	132

Capacity (kBtu/h)	Step	CMM	Static Pressure[mmAq(Pa)]										
			2.5(25)	3(29)	4(39)	5(49)	6(59)	7(69)	8(78)	9(88)	11(108)	12(118)	15(147)
			Setting Value										
			1step	2step	3step	4step	5step	6step	7step	8step	9step	10step	11step
36(38)	HIGH	30	66	69	71	76	80	84	86	91	97	101	105
	MID	25	62	65	67	72	76	80	82	87	92	97	101
	LOW	20	58	61	63	68	72	76	78	83	88	92	97

Capacity (kBtu/h)	Step	CMM	Static Pressure[mmAq(Pa)]										
			4(39)	5(49)	6(59)	7(78)	8(78)	9(88)	10(98)	11(108)	12(118)	13(127)	15(147)
			Setting Value										
			1step	2step	3step	4step	5step	6step	7step	8step	9step	10step	11step
48(53)	HIGH	40	83	89	92	94	98	100	102	105	108	110	116
	MID	34	78	82	84	89	94	96	98	101	104	106	112
	LOW	28	74	76	79	82	89	92	94	96	99	102	107
54(57/60)	HIGH	50	94	97	100	104	107	109	112	115	117	119	121
	MID	45	90	92	96	98	102	104	106	109	112	114	117
	LOW	40	82	89	92	94	98	100	102	105	108	110	113

! NOTE

1. Be sure to set the value referring table 1. Unexpected set value will cause mal-function.
2. Table 1 is based at 220-240 V. According to the fluctuation of voltage, air flow rate varies.
3. Factory Set(External Static Pressure) each Model

Capacity (kBtu/h)	Factory set (E.S.P.) mmAq(Pa)	Lower Limit (E.S.P.) mmAq(Pa)	Upper Limit (E.S.P.) mmAq(Pa)
18	6(59)	2(20)	15(147)
24(27)		2(20)	15(147)
30		2.5(25)	15(147)
36(38)		2.5(25)	15(147)
48(53)		4(39)	15(147)
54(57/60)		4(39)	15(147)

* If it is zero static pressure, please set value below Maximum value.

Capacity (kBtu/h)	Maximum value
18	115
24(27)	
30	
36(38)	98
48(53)	
54(57/60)	

Installer Setting – Auto ESP

This function automatically sets the rotation speed of the fans corresponding to each step of rated airflow for easy installation.

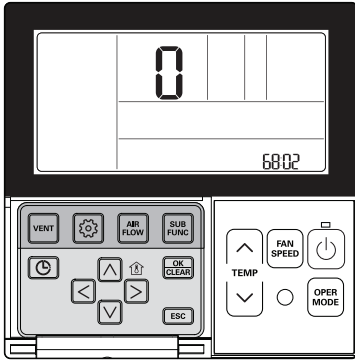



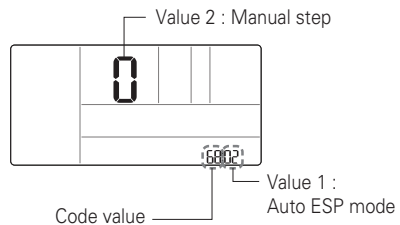

1 If  button is pressed so long for over 3 seconds, it enters to the installer setting mode.

- If it is pressed shortly for one time, it enters to the user setting mode. Be sure to press it for so long over 3 seconds.

2 If  button is pressed repeatedly, it is moved to Auto ESP setting menu as the picture below.



3 Press   button and select the setting value per each function.

- * The voltage can be set by setting the Auto ESP Mode to 'Manual (02)'. Move to the manual step settings using   button.
- * While 'Auto ESP' is being set, the display on the wired remote control changes as shown below, and the wired remote control cannot be operated.
- * Once the set-up is complete, you can enter installer setup (68) to check whether the set-up has succeeded or failed. (03: Success, 04: Failure)

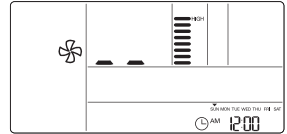
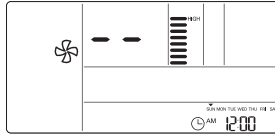
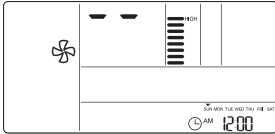

Value 1 (Auto ESP mode)	Value 2 (Manual Step)	Description (Voltage setting)
00 (Not use)	-	-
01 (Auto)	-	-
02 (Manual)	0	190 V
	1	200 V
	2	210 V
	3	220 V
	4	230 V
	5	240 V
	6	250 V
	7	260 V
8	270 V	
03	-	Cannot be set, only monitoring is possible. If the value1 is 03, setting is successful.
04	-	Cannot be set, only monitoring is possible. If the value1 is 04, setting has failed.

After selecting the corresponding function, press  button to complete the setting.

Press the  button to exit the setting mode.

- * If there would be no button input for about 25 seconds after setting, it exits from the setting mode automatically.
- * If it is exited without pressing  button, the handled value is not reflected.

! NOTE

If this function is incorrectly set especially, in case of mismatching the voltage, the air conditioner may malfunction.

This function must be set by the installation specialist that holds an installation license. (please check the product type)

! NOTE

- If the heat exchanger is not dry, please set the device to operate in air circulation mode for 15 minutes.
- The air filter must be properly attached to the suction side of the product.
- Adjust the dampers so that each air inlet and outlet exhaust the required air.
- Please do not use the set auto air flow function when using various booster fans (outdoor air treatment device or ERV through ducts).
- Please reinitiate the set auto air flow function if the duct shape has changed since its initial installation.
- When setting the voltage manually, the set air flow will differ from the actual air flow if the set voltage is different from the actual voltage.
- When setting voltage manually, measure the actual voltage and select the set voltage on the remote control.
- Failure to follow the above method may cause the actual air flow to differ from the rated air flow.

Installer Setting - How to enter installer setting mode

! CAUTION

Installer setting mode is to set the detail function of the remote controller. If the installer setting mode is not set correctly, it can cause problems to the product, user injury or property damage. This must be set by a certificated installer, and any installation or change that is carried out by a non-certificated person should be responsible for the results. In this case, free service cannot be provided.

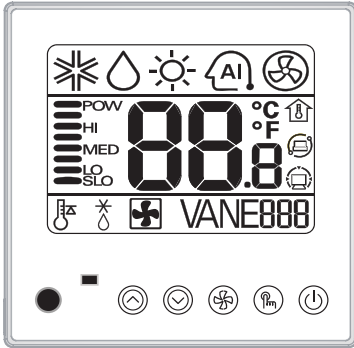

- 1 If you want to set installer setting mode, Press the Temperature up button and the oper mode button same time for five seconds.
- 2 When you enter the setting mode Initially. Function code is displayed on the LCD screen.

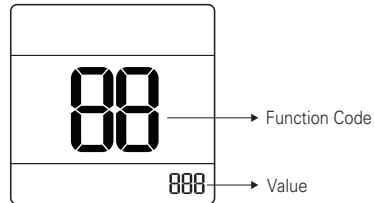

<Installer Setting Code Table> General air-conditioner product

No.	Function	Code	Value
1	Test Run	01	01:Set
2	Address Setting	02	00~FF : Address
3	E.S.P. Value	03	<ESP Step> <ESP Value><Example> 01:VeryLow 0 ~ 255 02:Low 03:Med 04:High 05:Very High <div style="text-align: right; margin-top: 10px;"> </div>
4	Thermistor	04	01:Remo 02:Indoor 03:2TH
5	Ceiling Height	05	01:Med 02:Low 03:High 04:Very High
6	Static Pressure	06	01:V-H 02:F-H 03:V-L 04:F-L
7	Master Setting	07	00:Slave 01:Master
8	Celsius Fahrenheit Switching	12	00:Celsius 01:Fahrenheit (Optimized only for U.S.A)
9	Static Pressure Step	32	00: use static pressure (code 06) set value 01~ 11: static pressure step (code 32) set value



* Some contents may not be displayed depending on the product function



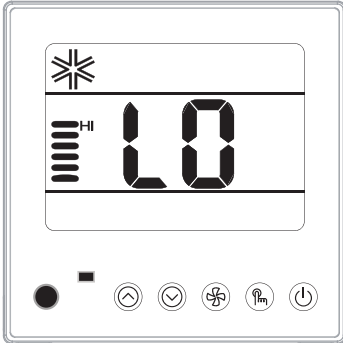

Installer Setting - Test Run Mode

After installing the product, you must run a Test Run mode.

For details related to this operation, refer to the product manual.



- 1** When pressing the  button and  button simultaneously for more than 3 seconds, the system will be entered into the installer setting mode.

 - After entering into the installer setting mode, select the test run mode code value by pressing the  button.
 - * Test run mode code value : 01
- 2** When pressing the  button, the test operation mode will be performed, and it is displayed as shown in the left figure.
- 3** When pressing the  button and  button simultaneously for more than 3 seconds after the setting has been completed, the setting mode will be released.

 - If there isn't any button input for more than 25 seconds, the installer setting mode will also be released.
- 4** When approx. 18 minutes are elapsed after starting of the test oper-mode, the system will be stopped automatically and converted to the standby state.

 - If any button is inputted during the test run mode, the test run mode will be forced to be released.

What is the test run mode?

- This means the operation of the product under the cooling, strong wind, and Comp on state without performing room temperature control in order to confirm the installed state during the product installation.

Installer Setting - Setting Address of Central Control

It's the function to use for connecting central control.

Please refer to central controller manual for the details

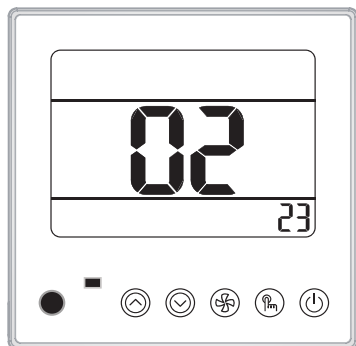

1 When pressing the button and button simultaneously for more than 3 seconds, the system will be entered into the installer setting mode.

- After entering into the installer setting mode, select the central control address setting code value by pressing the button.

* Setting address of central control code value : 02

2 Set up the group number and indoor unit with the temperature adjustment buttons.

— Group number

— Indoor unit number

For example, when setting as

[Group number=2 Indoor number=3]

it will be displayed as shown in the left figure.

3 When pressing the button, the system will be set up with the address value which has been established at present.

4 When pressing the button and button simultaneously for more than 3 seconds after the setting has been completed, the setting mode will be released.

- If there isn't any button input for more than 25 seconds, the installer setting mode will also be released.

- If you connect the indoor unit to the central controller, you should set the network address of the indoor unit so that the central controller could recognize it.

- The center-control address is composed of the group number and the indoor-unit number.

! NOTE



The remote controller displays 'HL' if central controller has locked the remote controller . In the case when the lock is set up at the central controller, 'HL' will be indicated on the display window of the wired remote controller and the indoor unit will not be controlled by the remote controller.



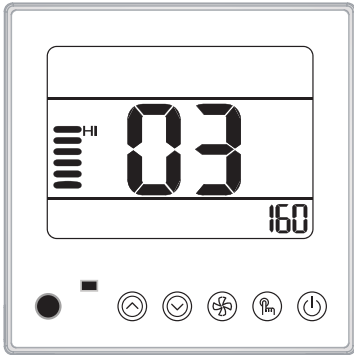

Installer Setting - E.S.P.



This is the function that decides the strength of the wind for each wind level and because this function is to make the installation easier.

- If you set ESP incorrectly, the air conditioner may malfunction.
- This setting must be carried out by a certificated-technician.



- 1 When pressing the  button and  button simultaneously for more than 3 seconds, the system will be entered into the installer setting mode.

 - After entering into the installer setting mode, select the E.S.P code value by pressing the  button.
 - * E.S.P code value : 03
- 2 Select the desired air flow rate with the  button. Whenever pressing the  button, [Lo→Med→Hi] will be indicated.
- 3 Select the desired air flow rate value with the temperature up () , down () button.

 - * E.S.P value range : 0~255
 - E.S.P value will be indicated at the upper right section of the display window.
- 4 When pressing the  button, currently established E.S.P value will be set up.
- 5 When pressing the  button and  button simultaneously for more than 3 seconds after the setting has been completed, the setting mode will be released.

 - If there isn't any button input for more than 25 seconds, the installer setting mode will also be released.

- Precaution shall be taken not to alter the E.S.P value corresponded to each air flow section.
- E.S.P value can be varied according to the products.
- In the case of going to the next air flow rate stage by pressing the fan-speed button during the setup of the E.S.P value, the E.S.P value of previous air flow rate will be maintained by remembering the E.S.P value prior to the shift.

Installer Setting - Thermistor

This is the function to select the temperature sensor to judge the room temperature.

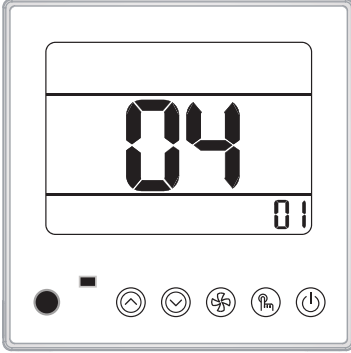

- 1 When pressing the button and button simultaneously for more than 3 seconds, the system will be entered into the installer setting mode.
 - After entering into the installer setting mode, select the thermistor sensor setting code value by pressing the .

* Thermistor sensor selection code value : 04

- 2 Select the desired setting value with the temperature up () , down () button.

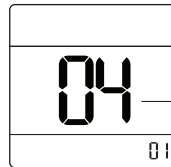

*Setting value
01: Remote controller
02: Indoor unit
03: 2TH

- 3 When pressing the button, currently established thermistor sensor location will be set up.
- 4 When pressing the button and button simultaneously for more than 3 seconds after the setting has been completed, the setting mode will be released.
 - If there isn't any button input for more than 25 seconds, the installer setting mode will also be released.

* As the characteristic of the '2TH' function can be different in accordance with the products, refer to the product instruction manual for its detail.

Installer Setting - Remote Controller Master/Slave Setup

It is a function for settings in group control, or 2-remote controller control.

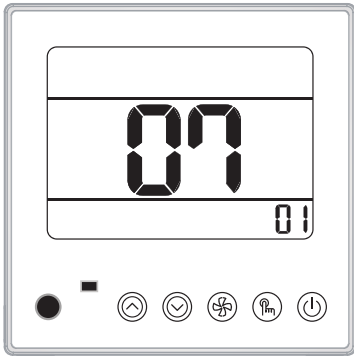

1 When pressing the button and button simultaneously for more than 3 seconds, the system will be entered into the installer setting mode.
 - After entering into the installer setting mode, select the ceiling height setting code value by pressing the oper-mode button.
 * Remote controller master/slave setting code value : 07

2 Select the desired setting value with the temperature up() , down() button.

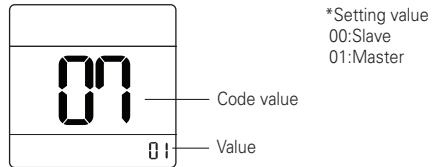

3 When pressing the button, currently established static pressure value will be set up.

4 When pressing the button and button simultaneously for more than 3 seconds after the setting has been completed, the setting mode will be released.
 - If there isn't any button input for more than 25 seconds, the installer setting mode will also be released.

Remote controller	Function
Master	Indoor unit operates based on master remote controller at group control. (Master is set when delivering from the warehouse.)
Slave	Setup all remote controllers except one master remote controller to slave at group control

* Refer to the 'group control' part for details

- When controlling in groups, basic operation settings, airflow strength weak/medium/strong, lock setting of the remote controller, time settings, and other functions may be restricted.

Installer Setting - Celsius / Fahrenheit Switching

This function is used for switching the display between Celsius and Fahrenheit.
(Optimized only for U.S.A)

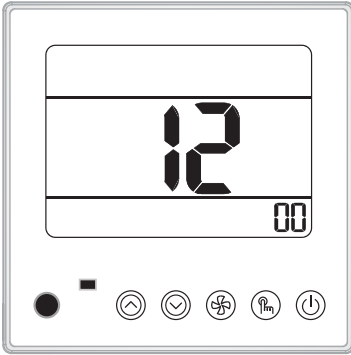

- 1 When pressing the button and button simultaneously for more than 3 seconds, the system will be entered into the installer setting mode.
- After entering into the installer setting mode, select the ceiling height setting code value by pressing the oper-mode button.
* Celsius/Fahrenheit setting code value : 12

- 2 Select the desired setting value with the temperature up() , down() button.

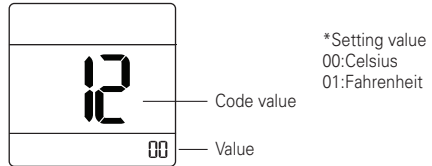

- 3 When pressing button, currently established celsius/Fahrenheit setting value will be set up.

- 4 When pressing the button and button simultaneously for more than 3 seconds after the setting has been completed, the setting mode will be released.
- If there isn't any button input for more than 25 seconds, the installer setting mode will also be released.

- Whenever press temp up , down button in Fahrenheit mode, the temperature will increase/drop 2 degrees.

Installer Setting - Static Pressure Step Setting

This function is applied to only duct type. Setting this in other cases will cause malfunction.

This function is only available on some products.

This is the function that static pressure of the product is divided in 11 steps for setting.

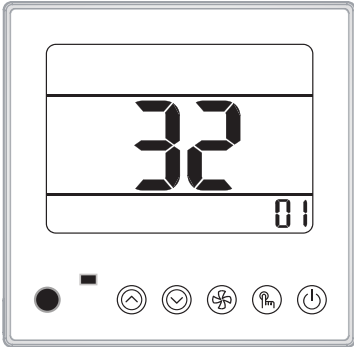

1 When pressing the button and button simultaneously for more than 3 seconds, the system will be entered into the installer setting mode.

- After entering into the installer setting mode, select the static pressure step setting code value by pressing the button.

* Static pressure step setting code value : 32

2 Select the desired setting value with the temperature up () , down () button.

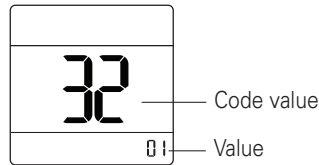

00: use static pressure (code 06) set value

01~ 11: static pressure step (code 32) set value

3 When pressing button, currently established static pressure value will be set up.

4 When pressing the button and button simultaneously for more than 3 seconds after the setting has been completed, the setting mode will be released.
- If there isn't any button input for more than 25 seconds, the installer setting mode will also be released.



- Static Pressure (Code 06) setting will not be used if Static Pressure Step (Code 32) setting is being used.

- For the static pressure value for each step, refer to the next page Table. 1

Installer Setting - Auto ESP

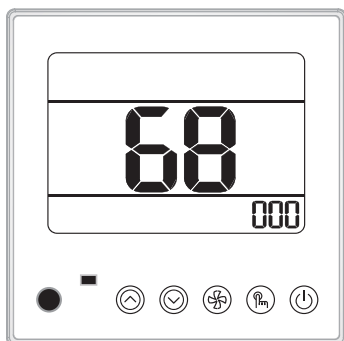
This function automatically sets the rotation speed of the fans corresponding to each step of rated airflow for easy installation.



1 When pressing the  button and  button simultaneously for more than 3 seconds, the system will be entered into the installer setting mode.



- If  button is pressed repeatedly, it is moved to Auto ESP setting menu as the picture below.

* Code value : 68

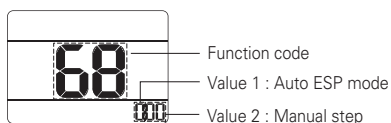
2 Set the auto ESP mode using the Temperature button and set the manual step using the Fan speed button.



3 Press  button to save the setting.

4 When pressing the  button and  button simultaneously for more than 3 seconds after the setting has been completed, the setting mode will be released.

- If there isn't any button input for more than 25 seconds, the installer setting mode will also be released.

- ※ The voltage can be set by setting the Auto ESP Mode to 'Manual (2)', then pressing the 'Fanspeed' button.
- ※ While 'Auto ESP' is being set, the display on the wired remote control changes as shown below, and the wired remote control cannot be operated.
- ※ Once the set-up is complete, you can enter installer setup (68) to check whether the set-up has succeeded or failed. (3: Success, 4: Failure)



Value 1 (Auto ESP mode)	Value 2 (Manual Step)	Description (Voltage setting)
0 (Not use)	-	-
1 (Auto)	-	-
2 (Manual)	00	190 V
	01	200 V
	02	210 V
	03	220 V
	04	230 V
	05	240 V
	06	250 V
	07	260 V
	08	270 V
3	-	Cannot be set, only monitoring is possible. If the value1 is 3, setting is successful.
4	-	Cannot be set, only monitoring is possible. If the value1 is 4, setting has failed.

! NOTE

If this function is incorrectly set especially, in case of mismatching the voltage, the air conditioner may malfunction.

This function must be set by the installation specialist that holds an installation license. (please check the product type)

! NOTE

- If the heat exchanger is not dry, please set the device to operate in air circulation mode for 15 minutes.
- The air filter must be properly attached to the suction side of the product.
- Adjust the dampers so that each air inlet and outlet exhaust the required air.
- Please do not use the set auto air flow function when using various booster fans (outdoor air treatment device or ERV through ducts).
- Please reinitiate the set auto air flow function if the duct shape has changed since its initial installation.
- When setting the voltage manually, the set air flow will differ from the actual air flow if the set voltage is different from the actual voltage.
- When setting voltage manually, measure the actual voltage and select the set voltage on the remote control.
- Failure to follow the above method may cause the actual air flow to differ from the rated air flow.

DIP SWITCH SETTING

18k / 24(27)k / 30k / 36(38)k / 48(53)k / 54(57/60)k

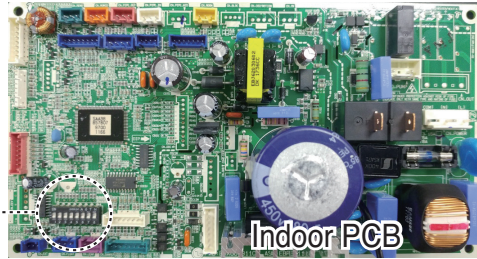
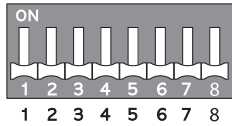

	Function	Description	Setting Off	Setting On	Default
SW3	Group Control	Selection of Master or Slave	Master	Slave	Off
SW4	Dry Contact Mode	Selection of Dry Contact Mode	Wired/Wireless remote controller Selection of Manual or Auto operation Mode	Auto	Off
SW5	Installation	Fan continuous operation	Continuous operation Removal	Working	Off

