

OWNER'S MANUAL

AIR CONDITIONER

Please read this manual carefully before operating your set and retain it for future reference.

FLOOR STANDING

APNH48GTLA0

AUJW486D2



MFL69166401
Rev.02_083122

www.lg.com

Copyright © 2015 - 2022 LG Electronics Inc. All Rights Reserved.

TIPS FOR SAVING ENERGY

Here are some tips that will help you minimize the power consumption when you use the air conditioner. You can use your air conditioner more efficiently by referring to the instructions below:

- Do not cool excessively indoors. This may be harmful for your health and may consume more electricity.
- Block sunlight with blinds or curtains while you are operating the air conditioner.
- Keep doors or windows closed tightly while you are operating the air conditioner.
- Adjust the direction of the air flow vertically or horizontally to circulate indoor air.
- Speed up the fan to cool or warm indoor air quickly, in a short period of time.
- Open windows regularly for ventilation as the indoor air quality may deteriorate if the air conditioner is used for many hours.
- Clean the air filter once every 2 weeks. Dust and impurities collected in the air filter may block the air flow or weaken the cooling / dehumidifying functions.

For your records

Staple your receipt to this page in case you need it to prove the date of purchase or for warranty purposes. Write the model number and the serial number here:

Model number : _____

Serial number : _____

You can find them on a label on the side of each unit.

Dealer's name : _____

Date of purchase : _____

IMPORTANT SAFETY INSTRUCTIONS

READ ALL INSTRUCTIONS BEFORE USING THE APPLIANCE.

Always comply with the following precautions to avoid dangerous situations and ensure peak performance of your product.

⚠ WARNING

It can result in serious injury or death when the directions are ignored.

⚠ CAUTION

It can result in minor injury or product damage when the directions are ignored.

⚠ WARNING

- Installation or repairs made by unqualified persons can result in hazards to you and others.
- Installation **MUST** conform with local building codes or, in the absence of local codes, with the Nation Electrical Code NFPA 70/ANSI C1-1003 or current edition and Canadian Electrical Code Part1 CSA C.22.1.
- The information contained in the manual is intended for use by a qualified service technician familiar with safety procedures and equipped with the proper tools and test instruments.
- Failure to carefully read and follow all instructions in this manual can result in equipment malfunction, property damage, personal injury and/or death.

Installation

- Do not use a defective or underrated circuit breaker. Use this appliance on a dedicated circuit. There is risk of fire or electric shock.
- For electrical work, contact the dealer, seller, a qualified electrician, or an Authorized Service Center. Do not

disassemble or repair the product. There is risk of fire or electric shock.

- Always ground the product. There is risk of fire or electric shock.
- Install the panel and the cover of control box securely. There is risk of fire or electric shock.
- Always install a dedicated circuit and breaker. Improper wiring or installation may cause fire or electric shock
- Use the correctly rated breaker or fuse. There is risk of fire or electric shock.
- Do not modify or extend the power cable. There is risk of fire or electric shock.
- Do not install, remove, or re-install the unit by yourself (customer). There is risk of fire, electric shock, explosion, or injury.
- Be cautious when unpacking and installing the product. Sharp edges could cause injury. Be especially careful of the case edges and the fins on the condenser and evaporator.
- For installation, always contact the dealer or an Authorized Service Center. There is risk of fire, electric shock, explosion, or injury.
- Do not install the product on a defective installation stand. It may cause injury, accident, or damage to the product.
- Be sure the installation area does not deteriorate with age. If the base collapses, the air conditioner could fall with it, causing property damage, product failure, and personal injury.
- Do not let the air conditioner run for a long time when the humidity is very high and a door or a window is left open. Moisture may condense and wet or damage furniture.

Operation

- Take care to ensure that power cable could not be pulled out or damaged during operation. There is risk of fire or electric shock.
- Do not place anything on the power cable. There is risk of fire or electric shock.

- Do not plug or unplug the power supply plug during operation. There is risk of fire or electric shock.
- Do not touch(operate) the product with wet hands. There is risk of fire or electrical shock.
- Do not place a heater or other appliances near the power cable. There is risk of fire and electric shock.
- Do not allow water to run into electric parts. There is risk of fire, failure of the product, or electric shock.
- Do not store or use flammable gas or combustibles near the product. There is risk of fire or failure of product.
- Do not use the product in a tightly closed space for a long time. Oxygen deficiency could occur.
- When flammable gas leaks, turn off the gas and open a window for ventilation before turning the product on. Do not use the telephone or turn switches on or off. There is risk of explosion or fire
- If strange sounds, smell or smoke comes from product. Turn the breaker off or disconnect the power supply cable. There is risk of electric shock or fire.
- Stop operation and close the window in storm or hurricane. If possible, remove the product from the window before the hurricane arrives. There is risk of property damage, failure of product, or electric shock.
- Do not open the inlet grill of the product during operation.(Do not touch the electrostatic filter, if the unit is so equipped.) There is risk of physical injury, electric shock, or product failure.
- When the product is soaked (flooded or submerged), contact an Authorized Service Center. There is risk of fire or electric shock.
- Be cautious that water should not enter the product. There is risk of fire, electric shock, or product damage.
- Ventilate the product from time to time when operating it together with a stove, etc. There is risk of fire or electric shock.
- Turn the main power off when cleaning or maintaining the product. There is risk of electric shock.

- When the product is not to be used for a long time, disconnect the power supply plug or turn off the breaker. There is risk of product damage or failure, or unintended operation.
- Take care to ensure that nobody should step on or fall onto the outdoor unit. This could result in personal injury and product damage.

CAUTION

Installation

- Always check for gas (refrigerant) leakage after installation or repair of product. Low refrigerant levels may cause failure of product.
- Install the drain hose to ensure that water is drained away properly. A bad connection may cause water leakage.
- Keep level even when installing the product. To avoid vibration or water leakage.
- Do not install the product where the noise or hot air from the outdoor unit could damage the neighborhoods. It may cause a problem for your neighbors.
- Use two or more people to lift and transport the product. Avoid personal injury.
- Do not install the product where it will be exposed to sea wind (salt spray) directly. It may cause corrosion on the product. Corrosion, particularly on the condenser and evaporator fins, could cause product malfunction or inefficient operation.

Operation

- Do not expose the skin directly to cool air for long periods of time. (Don't sit in the draft.) This could harm to your health.
- Do not use the product for special purposes, such as preserving foods, works of art, etc. It is a consumer air conditioner, not a precision refrigeration system. There is risk of damage or loss of property.

- Do not block the inlet or outlet of air flow. It may cause product failure.
- Use a soft cloth to clean. Do not use harsh detergents, solvents, etc. There is risk of fire, electric shock, or damage to the plastic parts of the product.
- Do not touch the metal parts of the product when removing the air filter. They are very sharp! There is risk of personal injury.
- Do not step on or put anything on the product. (outdoor units) There is risk of personal injury and failure of product.
- Always insert the filter securely. Clean the filter every two weeks or more often if necessary. A dirty filter reduces the efficiency of the air conditioner and could cause product malfunction or damage.
- Do not insert hands or other objects through the air inlet or outlet while the product is in operation. There are sharp and moving parts that could cause personal injury.
- Do not drink the water drained from the product. It is not sanitary and could cause serious health issues.
- Use a firm stool or ladder when cleaning or maintaining the product. Be careful and avoid personal injury.
- Replace all the batteries in the remote control with new ones of the same type. Do not mix old and new batteries or different types of batteries. There is risk of fire or explosion
- Do not recharge or disassemble the batteries. Do not dispose of batteries in the fire. They may burn or explode.
- If the liquid from the batteries gets onto your skin or clothes, wash it well with clean water. Do not use the remote if the batteries have leaked. The chemicals in batteries could cause burns or other health hazards.
- If you eat the liquid from the batteries, brush your teeth and see doctor. Do not use the remote if the batteries have leaked. The chemicals in batteries could cause burns or other health hazards.

TABLE OF CONTENTS

2 TIPS FOR SAVING ENERGY

3 IMPORTANT SAFETY INSTRUCTIONS

9 BEFORE USE

- 9 Preparing for operation
- 9 Usage
- 9 Cleaning and maintenance
- 9 Service

10 PRODUCT INTRODUCTION

- 10 Name of parts
- 11 Indoor unit controls and indicators
- 12 Remote control preparation
- 13 Wireless remote controller

15 OPERATING INSTRUCTIONS

<Type 1>

- 15 Operation Mode
- 16 Auto Dry Function
- 16 Airflow Setting
- 17 Power cooling, power heating operation
- 17 Adjusting the air speed
- 17 Timer
- 18 Defrost Mode
- 18 Child Lock Operation Function
- 18 Auto Re-Operation Function

<Type 2>

- 19 Cooling Mode
- 19 Heating Mode
- 19 Airflow Setting
- 19 Fan Speed Mode
- 20 Dehumidification Mode
- 20 Power Cooling/Heating Mode
- 20 Fan Mode
- 20 Auto Operation Mode
- 20 Simple Reservation
- 21 Defrost Mode
- 21 Child Lock Operation Function
- 21 Auto Re-Operation Function

22 MAINTENANCE AND SERVICE

- 22 Indoor Unit
- 23 When the air conditioner is not going to be used for a long time.
- 23 Operation Tips
- 24 Troubleshooting Tips! Save time and money!
- 24 Call the service immediately in the following situations

BEFORE USE

Preparing for operation

- Contact an installation specialist for installation.
- Use a dedicated circuit.

Usage

- Being exposed to direct airflow for an extended period of time could be hazardous to your health. Do not expose occupants, pets, or plants to direct airflow for extended period of time.
- Due to the possibility of oxygen deficiency, ventilate the room when used together with stoves or other heating devices.
- Do not use this air conditioner for non-specified special purposes (e.g. preserving precision devices, food, pets, plants, and art objects). Such usage could damage the items.

Cleaning and maintenance

- Do not touch the metal parts of the unit when removing the filter. Injuries can occur when handling sharp metal edges.
- Do not use water to clean inside the air conditioner. Exposure to water can destroy the insulation, leading to possible electric shock.
- When cleaning the unit, first make sure that the power and breaker are turned off. The fan rotates at a very high speed during operation. There is a possibility of injury if the unit's power is accidentally triggered on while cleaning inner parts of the unit.

Service

For repair and maintenance, contact your authorized service dealer.

PRODUCT INTRODUCTION

Name of parts

Indoor unit

1. Left/Right Airflow Control Louver
2. Up/Down Airflow Control Louver
3. Display/Control Panel
4. Filter
5. Air Inlet
6. Control Box

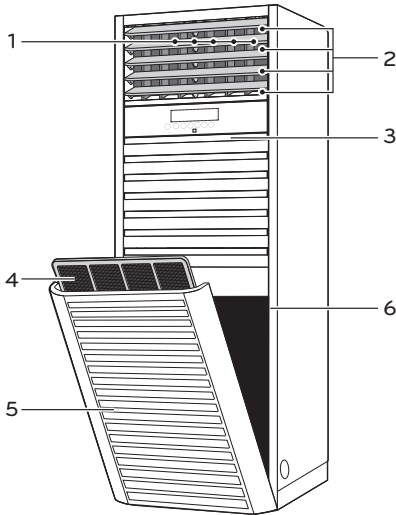

Outdoor unit

1. Air Outlet
2. Air Inlet (rear, side)
3. Bottom plate
4. Refrigerant Pipe Port

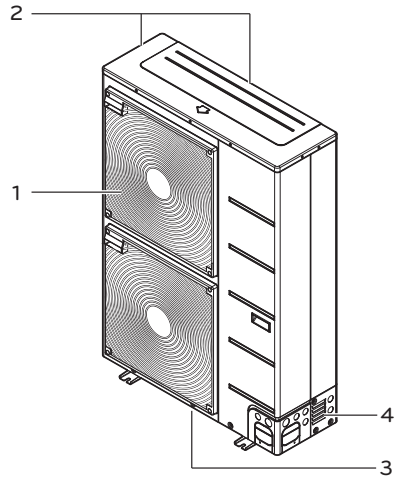

* Bottom plate is made of material that have corrosion endurance and is not painted in order to save environment.

Indoor unit controls and indicators

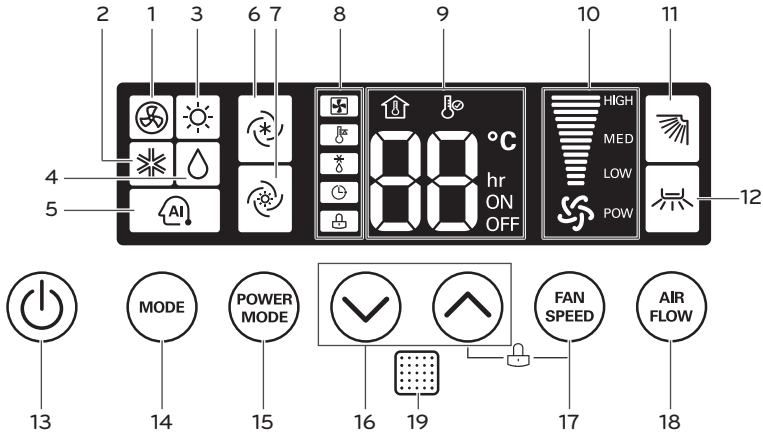

- | | |
|--|---------------------------------------|
| 1. Fan mode operation lamp | 10. Indoor fan speed lamp |
| 2. Cooling operation lamp | 11. Up/Down air flow lamp |
| 3. Heating operation lamp | 12. Left/Right air flow lamp |
| 4. Dehumidification operation lamp | 13. Start/Stop button |
| 5. Auto operation lamp | 14. Operation mode selection button |
| 6. Power cooling operation lamp | 15. Power cooling/heating mode button |
| 7. Power heating operation lamp | 16. Room temperature setting button |
| 8. Outdoor unit operation / Preheating / Defrost / Timer / Child lock lamp | 17. Indoor fan speed button |
| 9. Room temp. / Set temp. display (ON/OFF timer display) | 18. Air flow direction button |
| | 19. Signal receptor |

Remote control preparation

How to mount onto a wall

- 1 Use the screws to secure the holder to the wall or attach the holder side of indoor unit.

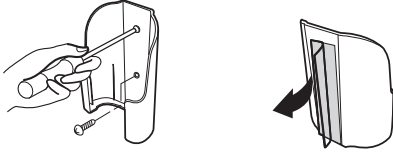

- 2 To insert the remote control to the holder.

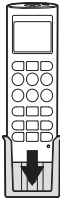

How to insert batteries

- 1 Remove the cover from the back of the remote controller.
 - Slide the cover according to the arrow direction.

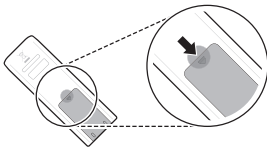

- 2 Insert two batteries.
 - Be sure that the (+) and (-) directions are correct.
 - Be sure that both batteries are new.

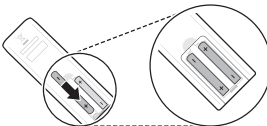

- 3 Re-attach the cover.
 - Slide the cover into back position.

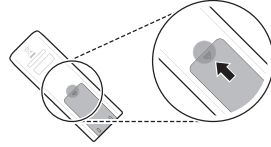

- Do not use rechargeable batteries such as NiMH batteries. Rechargeable batteries are different from standard dry cells in shape, dimensions, and performance.
- Change the batteries with a new one if the remote control does not work properly after using for an extended period of time.

CAUTION

- When not using remote controller for a long time, flowing of dry cell liquid may cause the failure of product, therefore, remove all dry cells.
- When replacing dry cell (AAA), replace two of them all with new ones, and if remote controller is not operated properly even after replacing the dry cells (AAA), request the service.
- Do not disassemble or re-charge the used dry cells, and do not throw away those at the location with heat of fire or hot air. There will be the danger of explosion.

Wireless remote controller

<Type 1>

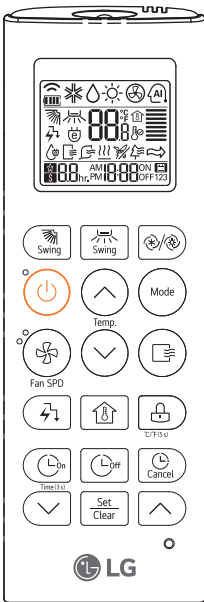

Control panel	Description
	You can turn the air conditioner on and off.
	You can easily adjust the desired air speed.
	You can adjust the desired temperature by pressing the buttons.
Mode	You can select the desired operation mode by pressing the appropriate button. <ul style="list-style-type: none"> Operation modes: Cooling, heating, dehumidification, air blowing, AI
	It automatically removes the moisture remaining inside the air conditioner when the air conditioner is turned off.
	You can set up/down rotation or left/right rotation.
	It can cool the indoor space at a rapid rate. <ul style="list-style-type: none"> If you wish to select power cooling, press the power mode button after pressing the cooling button. If you wish to select power heating, press the power mode button after pressing the heating button.
	You can bring the effect of the power saving. <ul style="list-style-type: none"> Capacity may decrease when this mode is selected.
	You Can check the indoor temperature. <ul style="list-style-type: none"> The room temperature is displayed for 3 seconds and then returns to the previous screen.
	When the lock function is set, the function won't change no matter which button on the product is pressed. <ul style="list-style-type: none"> In operation this function, display key will be locked and air conditioner indicates "CL" on its display panel whenever you press any button. If you press this button for 3 seconds, you can change temperature unit(°C/°F).
	ON reservation: The air conditioner turns on automatically at the set time. <ul style="list-style-type: none"> If you press this button for 3 seconds, you can set the current time.
	OFF reservation: The air conditioner turns off automatically at the set time.
	It cancels the set reservation.
	Set the desired reservation time by pressing the buttons.
SET/CLEAR	You can set or cancel reservations.

*Depending on the model, the functions applied may vary.

Handling the remote control

- Aim at the signal receptor on the floor standing type air conditioner when operating.
- The remote control signal can be received at a distance of up to about 7 meters.
- Be sure that there are no obstructions between the remote control and the signal receptor.
- Do not drop or throw the remote control.
- Do not place the remote control in a location exposed to direct sunlight, next to heating unit, or other heat sources.

NOTE

Some buttons cannot be used by model's function.

<Type 2>

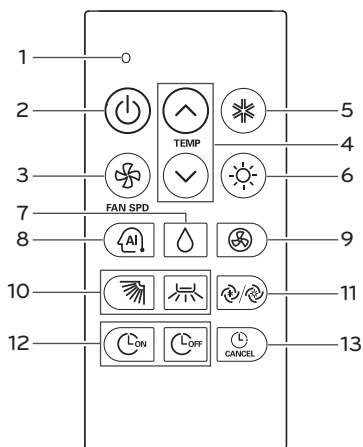

No.	Control panel	Description
1	○	Remote controller operation lamp
2	⏻	Power ON/OFF button : Operation will start when this button is pressed, and stop when the button is pressed again.
3	🌀 FAN SPD	Indoor fan speed button : To select the desired fan speed.
4	⬆️ ⬆️	Temperature setting button
5	❄️	Cooling button
6	☀️	Heating button
7	💧	Dehumidification button : Can effectively remove humidity when at the time of rainy season or high humidity.
8	🔄	Auto operation button : Auto heating and cooling operation is conducted in accordance with setting temperature.
9	🌀	Fan mode button
10	🌀	Air flow direction button(Up/down, Left/right) : Adjust air flow direction vertically or horizontally.
11	❄️/☀️	Power cooling/heating mode button : Powerful cooling/heating are performed within short time
12	🕒 LON LOFF	ON/OFF timer setting button : Set the time of starting or stopping
13	🕒 CANCEL	Timer cancel button

Handling the remote control



- Aim at the signal receptor on the floor standing type air conditioner when operating.
- The remote control signal can be received at a distance of up to about 7 meters.
- Be sure that there are no obstructions between the remote control and the signal receptor.
- Do not drop or throw the remote control.
- Do not place the remote control in a location exposed to direct sunlight, or next to a heating unit, or other heat source.

OPERATING INSTRUCTIONS

<Type 1>

Operation Mode









Cooling, Auto, Dehumidification, Heating, Air blowing operations

- 1 Turn on the air conditioner by pressing the  button on the remote control.
- 2 Select the desired operation mode by pressing the  button repeatedly.
(The operation mode is changed in the order of cooling, auto, dehumidification, heating and air blowing. In Cooling Only model, heating function does not work.)

NOTE

What is 3 minutes delay function?

The reason that cold wind is not coming out when operating the unit after turning off the cooling is because of the function to protect compressor. Cold wind will be coming out when compressor is operated after 3 minutes.



Operation mode	Description
Cooling	<p>Cold air is blown out of the air outlet.</p> <ul style="list-style-type: none"> • The cooling operation is the most basic operation mode. • You can set the desired temperature across a range of between 18 °C and 30 °C by pressing the temperature control buttons (, ).
Auto	<p>The air conditioner automatically blows air at the appropriate temperature for the indoor space.</p> <ul style="list-style-type: none"> • Cooling only: You can set the desired value across a range of between -2 and 2 by pressing the temperature control buttons (, ). - The closer to -2, the higher the desired temperature, and the closer to 2, the lower the desired temperature. • For both cooling and heating: You can adjust the desired temperature across a range of between 18 °C and 30 °C by pressing the temperature control buttons (, ).
Dehumidification	<p>You can remove moisture from the indoor space on a humid day for pleasant living.</p> <ul style="list-style-type: none"> • There is no separate desired temperature setting for the dehumidification operation. • The air speed starts from low, and you can adjust it to the desired speed as needed.
Heating	<p>Warm air is blown out of the air outlet.</p> <ul style="list-style-type: none"> • The heating operation is only available for an air conditioner in the cooling and heating modes. • You can set the desired temperature across a range of between 16 °C and 30 °C by pressing the temperature control buttons (, ).
Air blowing	<p>It circulates indoor air by blowing air at the same temperature as that of the indoor space.</p> <ul style="list-style-type: none"> • There is no separate desired setting temperature for the air blowing operation. • The air speed starts from high, and you can adjust it to the desired speed as needed.

Auto Dry Function

- 1 Auto dry function can be setted/released by manipulating indoor unit button or remote control.
- 2 When pressing the  button after setting the function, evaporator in indoor unit will be automatically dried as showing counting 00 to 99 on its display panel.
- 3 After indicating 99 on the display panel, the unit will be automatically turned off.

* Auto dry function is released at initial state as standard.



For Setting Auto Dry Function

If manipulating indoor unit, press the  button and  button simultaneously for 3 seconds.

If manipulating remote control for Cooling Only model, press  button.

The indoor unit will respond with beep once and indicate "SC" on its display panel. Then Auto dry function will be set.

For Releasing Auto Dry Function



If manipulating indoor unit, press the  button and  button simultaneously for 3 seconds.

If manipulating remote control, press  button. The indoor unit will respond with beep twice and Auto dry function will be removed.



Airflow Setting

We can simply adjust the desired airflow direction.



Up/Down Airflow Direction Control

- 1 Press  button to turn on the indoor.
- 2 Press  button and the louvers will swing up and down.
- 3 Press  button again to set the horizontal louver at the desired airflow direction.

Left/Right Airflow Direction Control



- 1 Press  button to turn on the indoor.
- 2 Press  button and the louvers will swing left and right.
- 3 Press  button again to set the vertical louver at the desired airflow direction.

<Airflow Setting Table>

Symbol	Description
	Up-Down : Vane move from up to down automatically and continuously
	Left-Right : Vane move from left to right automatically and continuously



Power cooling, power heating operation

It can be set when cooling or heating is set as the operation mode.

- Press the  button.
 - When cooling is selected as the operation mode, the power cooling operation will be activated.
 - When heating is selected as the operation mode, the power heating operation will be activated.
- When you press the  again, the power cooling or power heating function will be turned off.



Adjusting the air speed

You can adjust the air speed from the air outlet.

- Turn on the air conditioner by pressing the  button on the remote control.
- Select the desired air speed by repeatedly pressing the  button.
 - You can select the fan speed in four steps low, mid, high, super high. Each time the button is pressed, the fan speed mode is shifted.
 - Air speed stages may vary depending on the model.
 - Air flow rate can be selected during the cooling, dehumidification, blowing, and auto operation mode.

Timer

Setting the Current Time

- Press  button for 3 seconds.
- Press  or  button until the desired time is set.
 - If you press down and hold the button for a long time, the time will change more quickly in 10 minute increments.
- Press **SET/CLEAR** button.



NOTE

Check the indicator for A.M. and P.M.

Setting the On Timer

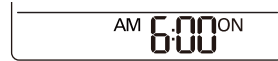
- Press ON button to turn the timer on or off.





- Press  or  button until the desired time is set.
- Press **SET/CLEAR** button.

Setting the Off Timer

- Press OFF button to turn the timer on or off.



- Press  or  button until the desired time is set.
- Press **SET/CLEAR** button.

Canceling the Timer Setting

You can cancel all timer settings.

- Press  button.

NOTE

- If you wish to cancel a specific timer setting, press the each timer button to turn on or off the Sleep Timer, On Timer, or Off Timer as you want. Then press the  button while aiming the remote controller at the signal receptor.
- The timer lamp on the air conditioner and the display will go off.

Defrost Mode

- 1 During defrost operation, δ will be indicated at display section of indoor.



- 2 During heating operation, if outside temperature is low and humidity is high, heating capability will be deteriorated as frost is generated at outdoor unit, therefore, the frost will be removed by performing defrost operation.
- 3 When indoor and outdoor unit fans are automatically stopped and defrost operation is completed, preheating for heating cycle will automatically be started.

* Heating operation will be started in a little time.

NOTE

What is preheating function for heating cycle?

- During the heating, indoor fan will not be operated until indoor tubing temperature becomes more than 22 °C, therefore, this is the function to block the discharge of cold wind.
- During the preheating for heating cycle, heating cannot be performed.
- During defrost operation, vapor can be generated at outdoor side, and this is not a failure because it is the operation to remove frost.

Child Lock Operation Function

- 1 Press the fan speed button and high temperature setting buttons simultaneously for seconds.
- 2 During child lock operation,
 - Whenever you press any button on display panel, it will immediately display "CL", which means display panel is locked.
 - All the button on the indoor unit display panel will not work.
 - But the button on the remote controller will be operated.

- 3 Press the low and high temperature setting buttons simultaneously for 3 seconds again. The unit will respond with beep. child lock operation will be removed.

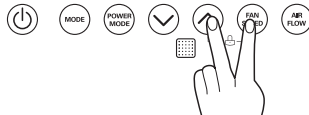

Auto Re-Operation Function

When power is supplied again after unit operation has been stopped because of interruption of power supply due to outage or other causes, auto re-operation will be performed by remembering previous setting.

- When power is supplied, outdoor unit operation will be started within 3 minutes.

- 1 Auto re-operation function can be established/released by manipulating indoor unit button.

* When initial state, Auto re-operation function will be set up as standard.

For Releasing Re-Operation Function

Press the on/off, fan speed, high temp and low temp buttons (4 buttons) simultaneously for 3 seconds.

The unit will respond with beep and re-operation function will be removed.

For Setting Re-Operation Function



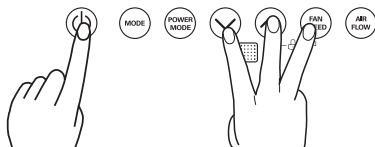

After function release, Press the on/off, fan speed, high temp and low temp buttons (4 buttons) simultaneously for 3 seconds.

The unit will respond with beep and re-operation function will be setted.



<Type 2>

Cooling Mode





- 1 Press  button to turn on the indoor.
- 2 Press  button to select Cooling operation mode.
 - When canceling operating, press  button once more.
- 3 Adjust the desired temperature by pressing ( ) buttons.
 - If desired temperature is higher than room temperature, cooling cannot be conducted.
 - Set the temperature lower than the room temperature
 - Setting Temp Range : 18°C~30°C.

NOTE

What is 3 minutes delay function?

The reason that cold wind is not coming out when operating the unit after turning off the cooling is because of the function to protect compressor. Cold wind will be coming out when compressor is operated after 3 minutes.

Heating Mode

- 1 Press  button to turn on the indoor.
- 2 Press  button to select Heating operation mode.
 - When canceling operation, press  button once more.
- 3 Adjust the desired temperature by pressing ( ) buttons.
 - If desired temperature is lower than room temperature, heating cannot be conducted.
 - Set up desired temperature higher than the room temperature
 - Setting Temp Range : 16°C~30°C.

NOTE



Preheating operation

When conducting heating operation at the condition of low outdoor temperature, the case that wind is not coming out for several minutes under the state of lighting of defrost lamp may be occurred. This is the preheating stage to supply warm wind which will be supplied subsequently in short time.



Airflow Setting

We can simply adjust the desired airflow direction.



Up/Down Airflow Direction Control

- 1 Press  button to turn on the indoor.
- 2 Press  button and the louvers will swing up and down.
- 3 Press  button again to set the horizontal louver at the desired airflow direction.



Left/Right Airflow Direction Control

- 1 Press  button to turn on the indoor.
- 2 Press  button and the louvers will swing left and right.
- 3 Press  button again to set the vertical louver at the desired airflow direction.

<Airflow Setting Table>



Symbol	Description
	Up-Down : Vane move from up to down automatically and continuously
	Left-Right : Vane move from left to right automatically and continuously

Fan Speed Mode

- 1 Press  button to turn on the indoor.
- 2 Press  button to select fan speed.
 - You can select the fan speed in four steps low, mid, high, super high. Each time the button is pressed, the fan speed mode is shifted.
 - Air flow rate can be selected during the cooling, heating, dehumidification, blowing, and auto operation mode.
 - Air speed stages may vary depending on the model.



Dehumidification Mode

In rainy season or high humidity climate, it is possible to operate simultaneously dehumidifier and cooling mode to remove humidity effectively.



- 1 Press  button to turn on the indoor.
- 2 Press  button to select dehumidification mode
 - Room temperature will be displayed after desired temperature is indicated at display section for about 5 seconds.

Power Cooling/Heating Mode



Strong cooling/heating will be conducted in short time.



- 1 Press  button to turn on the indoor.
- 2 Press  button to operate power cooling/heating mode.
 - When power (cooling/heating) button is pressed during cooling/dehumidification mode, power cooling will be operated. In power cooling mode, desired temperature is set to 18°C and the horizontal louver is fixed at the highest position.
 - When power (cooling/heating) button is pressed during heating operation, power heating will be operated. In power heating mode, desired temperature is set to 30°C and the horizontal louver is fixed at the lowest position.

Fan Mode

- 1 Press  button to turn on the indoor.
- 2 Press  button to circulate indoor air.
 - When canceling operation, press  button once more.
 - During fan mode, outdoor fan and compressor will not be operated.

Auto Operation Mode

- 1 Press  button to turn on the indoor.
- 2 Press  button to select Auto Operation Mode.

- 3 Adjust the desired temperature by pressing ( ) buttons.
 - When room temperature is higher than desired temperature, cooling operation will be performed, and when it is lower, heating operation will be conducted.
 - The temperature established by customer will be maintained through automatic performance of cooling/heating operation in accordance with the change of room temperature.

Simple Reservation

Turning ON reservation mode

This function is able to turn on unit after a setting time.

- 1 When the unit is turned off, adjust desired setting time with  button.
 - Up to the maximum of 24 hours can be selected.

Turning OFF reservation mode

This function is able to turn off unit after a setting time.

- 1 When the unit is turned on, adjust desired setting time with  button.
 - Up to the maximum of 7 hours can be selected.

NOTE

After performing the setting, if corresponded setting button is pressed once, remaining setting time will be displayed, and if it is pressed once again, corresponded setting function will be cancelled. (same function as ) Remaining setting time will be displayed with the unit of 1 hour.

Defrost Mode

- 1 During defrost operation, δ will be indicated at display section of indoor.

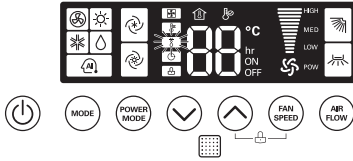

- 2 During heating operation, if outside temperature is low and humidity is high, heating capability will be deteriorated as frost is generated at outdoor unit, therefore, the frost will be removed by performing defrost operation.
- 3 When indoor and outdoor unit fans are automatically stopped and defrost operation is completed, preheating for heating cycle will automatically be started.

* Heating operation will be started in a little time.

NOTE

What is preheating function for heating cycle?

- During the heating, indoor fan will not be operated until indoor tubing temperature becomes more than 22 °C, therefore, this is the function to block the discharge of cold wind.
- During the preheating for heating cycle, heating cannot be performed.
- During defrost operation, vapor can be generated at outdoor side, and this is not a failure because it is the operation to remove frost.

Child Lock Operation Function

- 1 Press the fan speed button and high temperature setting buttons simultaneously for seconds.
- 2 During child lock operation,
 - Whenever you press any button on display panel, it will immediately display "CL", which means display panel is locked.
 - All the button on the indoor unit display panel will not work.
 - But the button on the remote controller will be operated.

- 3 Press the low and high temperature setting buttons simultaneously for 3 seconds again. The unit will respond with beep. child lock operation will be removed.

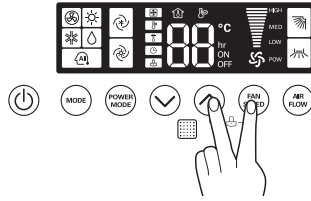

Auto Re-Operation Function

When power is supplied again after unit operation has been stopped because of interruption of power supply due to outage or other causes, auto re-operation will be performed by remembering previous setting.

- When power is supplied, outdoor unit operation will be started within 3 minutes.

- 1 Auto re-operation function can be established/released by manipulating indoor unit button.

* When initial state, Auto re-operation function will be set up as standard.

For Releasing Re-Operation Function

Press the on/off, fan speed, high temp and low temp buttons (4 buttons) simultaneously for 3 seconds.

The unit will respond with beep and re-operation function will be removed.

For Setting Re-Operation Function

After function release, Press the on/off, fan speed, high temp and low temp buttons (4 buttons) simultaneously for 3 seconds.

The unit will respond with beep and re-operation function will be setted.

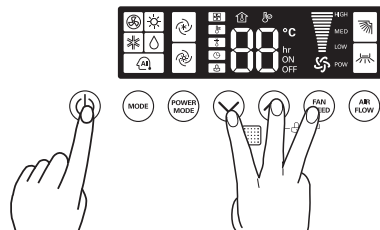

MAINTENANCE AND SERVICE

Indoor Unit

Grille, Case and Remote Control

- Turn the system off before cleaning, To clean, wipe with a soft, dry cloth. Do not use bleach or abrasives.

NOTE

Supply power must be disconnected before cleaning the indoor unit.

Air Filters

The air filters behind the front grille should be checked and cleaned once every 2 weeks or more often if necessary.

- Never use any of the followings:

Water hotter than 40 °C.
Could cause deformation and/or discoloration.

Volatile substances.
Could damage the surfaces of the air conditioner.



Filter Cleaning

Please clean it once in a week.

- 1 Remove the Air filters.
 - Take hold of the tab and pull slightly forward to remove the filter.

CAUTION

When the air filter is to be removed, do not touch the metal parts of the indoor unit. It may cause an injury.

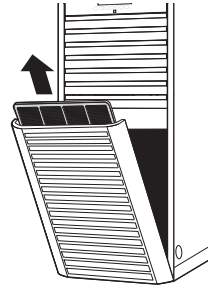

- 2 Clean dirt from the air filter using a vacuum cleaner or washing with water.
 - If dirt is conspicuous, wash with a neutral detergent in lukewarm water.
 - If hot water (50 °C or more) is used, it may be deformed.
- 3 After washing with water, dry well in the shade.
 - Do not expose the air filter to direct sunlight or heat from a fire when drying it.

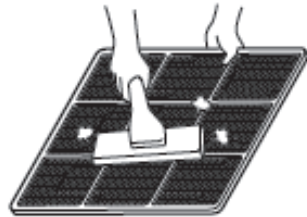

- 4 Install the air filter.

When the air conditioner is not going to be used for a long time.

When air conditioner is not going to be used for a long time.

- 1 Operate the air conditioner at the following settings for 2 to 3 hours.
 - Type of operation: Fan operation mode.
 - This will dry out the internal mechanisms.

! CAUTION

Turn off the breaker when the air conditioner is not going to be used for a long time.
Dirt may collect and may cause a fire.

Helpful information

The air filters and your electric bill.
If the air filters become clogged with dust, the cooling capacity will drop, and 6 % of the electricity used to operate the air conditioner will be wasted.

When the air conditioner is to be used again.

- 1 Clean the air filter and install it in the indoor unit.
- 2 Check that the air inlet and outlet of the indoor/outdoor unit are not blocked.
- 3 Check that the ground wire is connected correctly. It may be connect to the indoor unit side.

Operation Tips

<p>Do not overcool the room. This is not good for the health and wastes electricity.</p>	<p>Keep blinds or curtains closed. Do not let direct sunshine enter the room when the air conditioner is in operation.</p>	<p>Keep the room temperature uniform. Adjust the vertical and horizontal airflow direction to ensure a uniform temperature in the room.</p>
<p>Make sure that the doors and windows are shut tight. Avoid opening doors and windows as much as possible to keep the cool air in the room.</p>	<p>Clean the air filter regularly. Blockages in the air filter reduces the airflow and lowers the cooling and dehumidifying effects. Clean at least once every two weeks.</p>	<p>Ventilate the room occasionally. Since windows are kept closed, it is a good idea to open them and ventilate the room now and then.</p>

Troubleshooting Tips! Save time and money!

Check the following points before requesting repairs or service.... If the malfunction persist, please contact your dealer.

<p>The air conditioner does not operate.</p> <ul style="list-style-type: none"> - Have you made a mistake in timer operation? - Has the fuse blown or has the circuit breaker been tripped? 	<p>The room has a peculiar odor.</p> <ul style="list-style-type: none"> - Check that this is not a damp smell exuded by the walls, carpet, furniture or cloth items in the room. 	<p>It seems that condensation is leaking from the air conditioner.</p> <ul style="list-style-type: none"> - Condensation occurs when the airflow from the air conditioner cools the warm room air. 	<p>Air conditioner does not operate for about 3 minutes when restart.</p> <ul style="list-style-type: none"> - This is the protector of the mechanism. - Wait about three minutes and operation will begin.
<p>Does not cool or heat effectively.</p> <ul style="list-style-type: none"> - Is the air filter dirty? See air filter cleaning instructions. - The room may have been very hot when the room air conditioner was first turned on. Allow time for it to cool down. - Has the temperature been set incorrectly? - Are the indoor unit's air inlet or outlet vents obstructed? 	<p>The air conditioner operation is noisy.</p> <ul style="list-style-type: none"> - For a noise that sounds like water flowing. <ul style="list-style-type: none"> * This is the sound of freon flowing inside the air conditioner unit. - For a noise that sounds like the compressed air releasing into atmosphere. <ul style="list-style-type: none"> -This is the sound of the dehumidifying water being processed inside the air conditioning unit. 	<p>Crack sound is heard.</p> <ul style="list-style-type: none"> - This sound is generated by the expansion/ constriction of the front panel, etc. due to changes of temperature. 	<p>Remote control display is faint, or no display at all.</p> <ul style="list-style-type: none"> - Are the batteries depleted? - Are the batteries inserted in the opposite (+) and (-) directions? <p>The error code is occurred after lightning struck</p> <ul style="list-style-type: none"> - This product has been applied to the over current protection circuit. Error can occur, but it is normal behavior. After few minutes, It will operate normally.

Call the service immediately in the following situations

- 1 Anything abnormal such as burning smell, loud noise etc. happen. Stop the unit and turn the breaker off. Never try to repair by yourself or restart the system in such cases.
- 2 Main power cord is too hot or damaged.
- 3 Error code is generated by self diagnosis.
- 4 Water leaks from indoor unit even if the humidity is low.
- 5 Any switch, breaker (safety, earth) or fuse fails to work properly

User must carry routine checkup & cleaning to avoid unit's poor performance.

In case of special situation, the job must be carried out by service person only.



İTHALATÇI FİRMA

Arçelik-LG Klima Sanayi ve Ticaret A.Ş.

Merkez Adresi :

Gebze Organize Sanayi Bölgesi, İhsan

Dede Cad. No: 139, 41480 Gebze Kocaeli

Telefonu : (0262) 678 78 78

Telefaksı : (0262) 678 78 79

ÜRETİCİ FİRMA

LG Electronics Inc.

Changwon 2nd factory 84, Wanam-ro,

Seongsan-gu, Changwon-si

Gyeongsangnam-do, KOREA

www.lg.com