

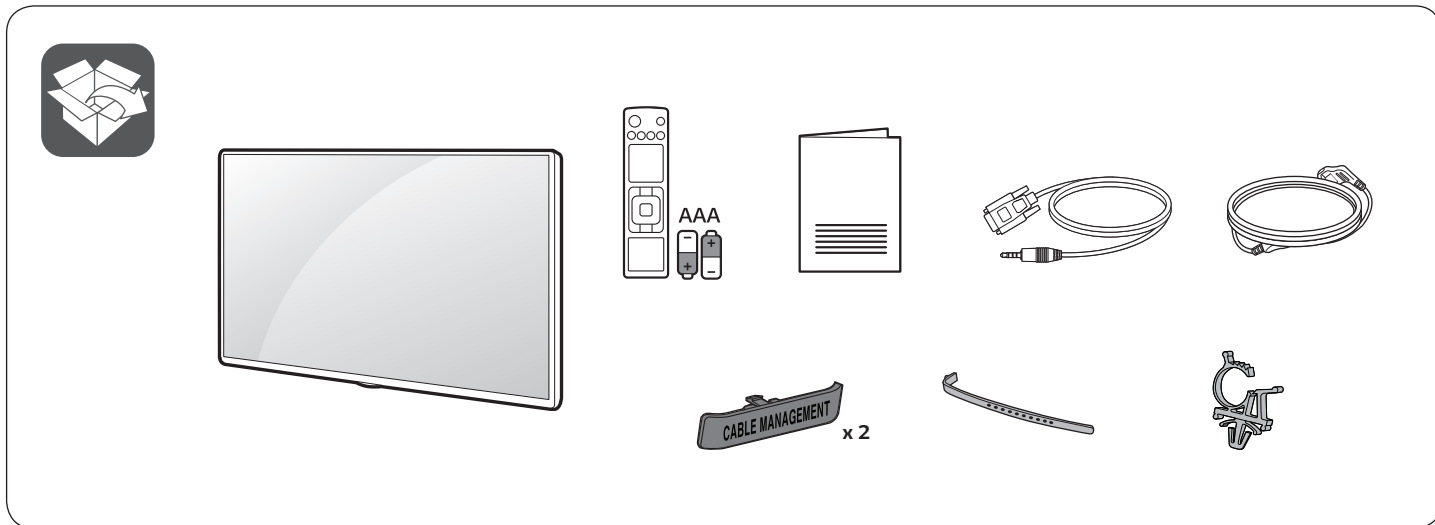

**LED TV**  
50/55/65UR762H\*  
50/55/65UR765H\*



⊕ : Depending on model / Selon le modèle / Tergantung pada modelnya / حسب الطراز



[www.lg.com](http://www.lg.com)



### English

• Read **Safety and Reference**.

• For the power supply and power consumption, refer to the label attached to the product.

**WARNING** : To prevent injury, this apparatus must be securely attached to the desk/wall in accordance with the **Safety and Reference**.

### Français

• Lire le document **Sécurité et référence**.

• Reportez-vous à l'étiquette apposée sur le téléviseur pour connaître l'alimentation et la consommation électriques.

**AVERTISSEMENT** : pour éviter toute blessure, cet appareil doit être fermement fixé au bureau/mur conformément aux instructions dans **Sécurité et référence**.

### Bahasa Indonesia

• Baca **Keselamatan dan Referensi**.

• Untuk informasi catu daya dan konsumsi daya, baca label yang disertakan pada produk.

**PERINGATAN** : Untuk mencegah cedera, peralatan ini harus terpasang dengan aman ke meja/dinding sesuai dengan **Keselamatan dan Referensi**.

- قراءة الأمان والمرجع .
  - لمعرفة المزيد حول مصدر الإمداد بالطاقة المطلوب ومعايير استهلاك الطاقة، راجع الملصق الموجود على المنتج .
- تحذير: لمنع الإصابة، يجب تثبيت هذا الجهاز بإحكام بالطاولة/الجدار طبقاً للسلامة والمرجع.

العربية

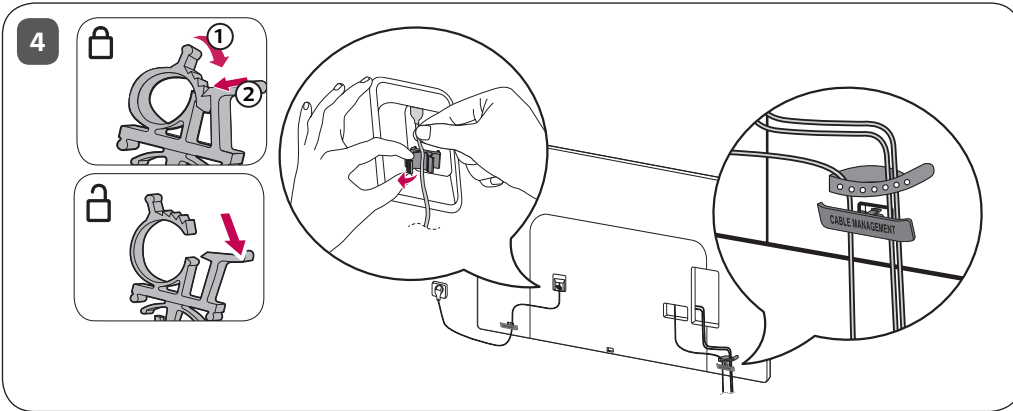
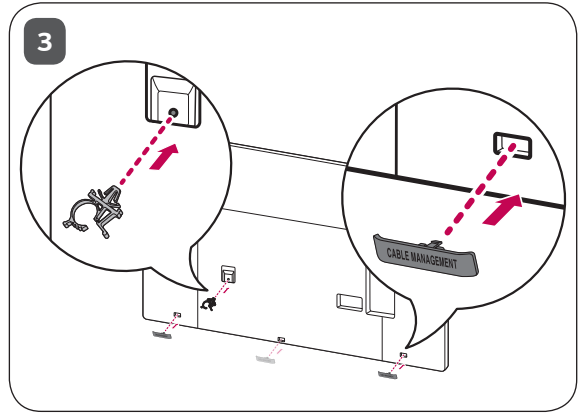
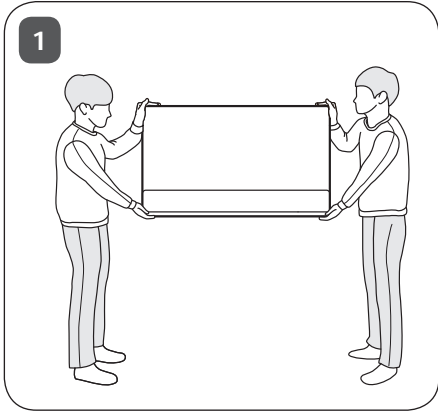

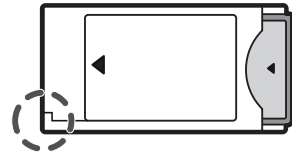
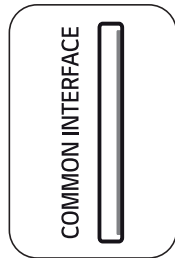
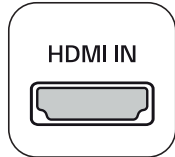
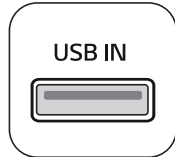
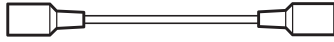
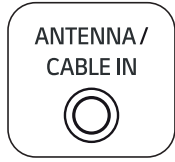
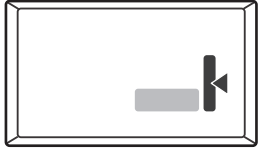

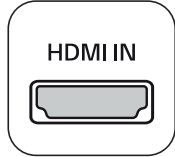
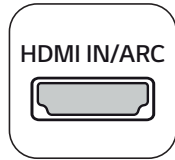
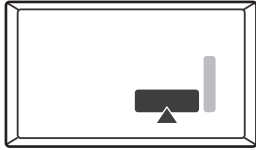

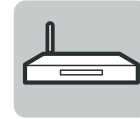
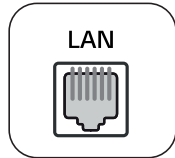
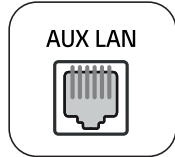
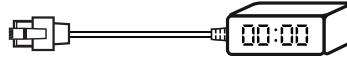
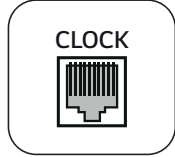
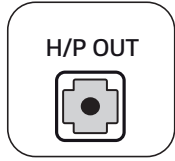
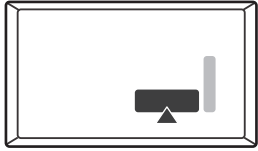

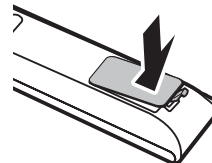
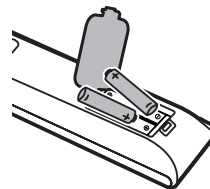
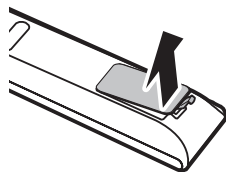
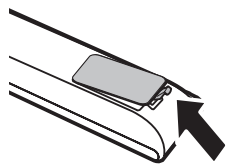
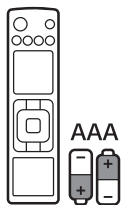



(2203-REV01)

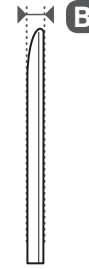
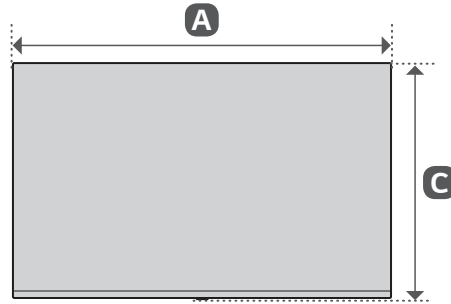

	A	B	C	D
	(mm)			(kg)
50UR762H0GC 50UR762H9GC 50UR765H0VC	1121	57.1	651	12.1
55UR762H0GC 55UR762H9GC 55UR765H0VC	1235	57.5	715	14
65UR762H0GC 65UR762H9GC 65UR765H0VC	1454	57.7	838	21.5
Power requirement / Alimentation / Persyaratan daya / متطلبات الطاقة	AC 100-240 V~ 50/60 Hz			تيار متردد 240-100 فولت ~ 60/50 هرتز