



OWNER'S MANUAL

# Wireless Sound Bar

Please read this manual carefully before operating your set and retain it for future reference.

MODEL  
LAS454B (LAS454B, S55A3-D)



# Safety Information



**CAUTION:** TO REDUCE THE RISK OF ELECTRIC SHOCK DO NOT REMOVE COVER (OR BACK) NO USER-SERVICEABLE PARTS INSIDE REFER SERVICING TO QUALIFIED SERVICE PERSONNEL.

This lightning flash with arrowhead symbol within an equilateral triangle is intended to alert the user to the presence of uninsulated dangerous voltage within the product's enclosure that may be of sufficient magnitude to constitute a risk of electric shock to persons.



The exclamation point within an equilateral triangle is intended to alert the user to the presence of important operating and maintenance (servicing) instructions in the literature accompanying the product.



**WARNING:** TO PREVENT FIRE OR ELECTRIC SHOCK HAZARD, DO NOT EXPOSE THIS PRODUCT TO RAIN OR MOISTURE.

**CAUTION:** The apparatus should not be exposed to water (dripping or splashing) and no objects filled with liquids, such as vases, should be placed on the apparatus.

**WARNING:** Do not install this equipment in a confined space such as a book case or similar unit.

**CAUTION:** Do not use high voltage products around this product. (ex. Electrical swatter) This product may malfunction due to electrical shock.

**CAUTION:** No naked flame sources, such as lighted candles, should be placed on the apparatus.

**CAUTION:** Do not block any ventilation openings. Install in accordance with the manufacturer's instructions.

Slots and openings in the cabinet are provided for ventilation and to ensure reliable operation of the product and to protect it from over heating. The openings shall be never be blocked by placing the product on a bed, sofa, rug or other similar surface. This product shall not be placed in a built-in installation such as a bookcase or rack unless proper ventilation is provided or the manufacturer's instruction has been adhered to.

## CAUTION concerning the Power Cord

Most appliances recommend they be placed upon a dedicated circuit;

That is, a single outlet circuit which powers only that appliance and has no additional outlets or branch circuits. Check the specification page of this owner's manual to be certain. Do not overload wall outlets. Overloaded wall outlets, loose or damaged wall outlets, extension cords, frayed power cords, or damaged or cracked wire insulation are dangerous. Any of these conditions could result in electric shock or fire. Periodically examine the cord of your appliance, and if its appearance indicates damage or deterioration, unplug it, discontinue use of the appliance, and have the cord replaced with an exact replacement part by an authorized service center. Protect the power cord from physical or mechanical abuse, such as being twisted, kinked, pinched, closed in a door, or walked upon. Pay particular attention to plugs, wall outlets, and the point where the cord exits the appliance. The Power Plug is the disconnecting device. In case of an emergency, the Power Plug must remain readily accessible.

This device is equipped with a portable battery or accumulator.

**Safety way to remove the battery from the equipment:** Remove the old battery or battery pack, follow the steps in reverse order than the assembly. To prevent contamination of the environment and bring on possible threat to human and animal health, the old battery or the battery put it in the appropriate container at designated collection points. Do not dispose of batteries or battery together with other waste. It is recommended that you use local, free reimbursement systems batteries and accumulators. The battery should not be exposed to excessive heat such as sunshine, fire or the like.

# Table of Contents

## 1 Getting Started

---

- 3 Safety Information
- 6 Unique features
- 6 Introduction
  - 6 – Symbols used in this manual
- 6 Accessories
- 7 Remote control
- 8 Front panel
- 8 Rear panel
- 9 Installing the sound bar
- 10 Mounting the main unit on a wall

## 2 Connecting

---

- 12 Wireless subwoofer connection
- 13 Connecting to your TV
  - 13 – Using an OPTICAL cable
- 14 Optional equipment connection
- 14 OPTICAL IN connection
- 14 – PORTABLE IN connection

## 3 Operating

---

- 15 Operations
  - 15 – DRC (Dynamic Range Control)
  - 15 – Turn off the sound temporarily
  - 15 – Using your TV remote control
  - 16 – AUTO POWER On/Off
  - 16 – Auto function change
- 17 Using BLUETOOTH® technology
  - 17 – Listening to music stored on the BLUETOOTH devices
- 18 Sound adjustment
  - 18 – Setting sound effect
  - 18 – Adjust the woofer level settings

## 4 Troubleshooting

---

- 19 Troubleshooting
- 20 NOTES to use wireless

## 5 Appendix

---

- 21 Trademarks and licenses
- 22 Specifications
- 23 Maintenance
  - 23 – Handling the unit

1

2

3

4

5

## Unique features

### Auto power down

This unit will turn off by itself for energy saving consumption.

### Portable In

Listen to music from your portable device. (MP3 player, Notebook, Smart phone, etc..)

## Introduction

### Symbols used in this manual

 Note

Indicates special notes and operating features.

 Caution

Indicates cautions for preventing possible damages from abuse.

## Accessories

Please check and identify the supplied accessories. Designs and specifications of the accessories are subject to change without prior notice.



Remote control (1)

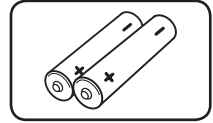

Batteries (2)

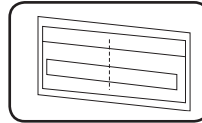

Wall Bracket Install guide (1)

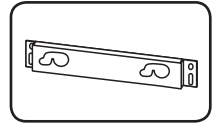

Wall bracket (1)

## Remote control

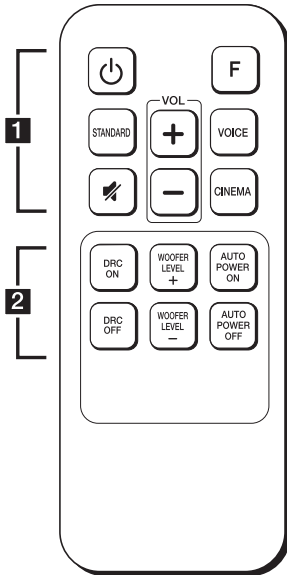

..... **1** .....

⏻ (Power): Switches the unit ON or OFF.

F : Changes input sources.

**STANDARD** : Selects STANDARD sound effect

**VOICE** : Selects VOICE sound effect

**CINEMA** : Selects CINEMA sound effect

🔇 (Mute) : Mutes the sound.

**VOL +/−** : Adjusts speaker volume.

..... **2** .....

**DRC ON/OFF** : Turns on or off DRC function.  
(Refer to the page 15.)

**WOOFER LEVEL +/−** : Adjusts sound level of subwoofer.

**AUTO POWER ON/OFF**: Turns on or off AUTO POWER function. (Refer to the page 16.)

## Replacement of battery

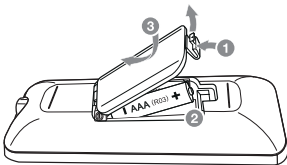

Remove the battery cover on the rear of the Remote Control, and insert two R03 (size AAA) batteries with + and − matched correctly.

# Front panel

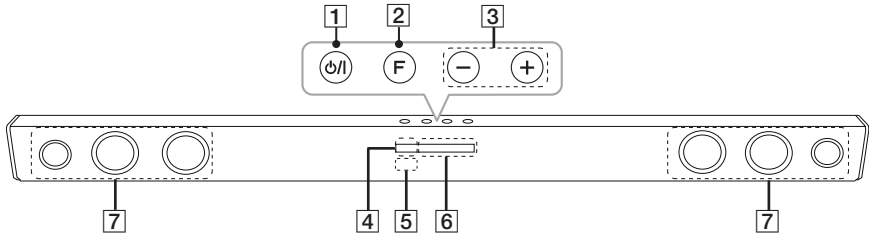

- 1 ⏻/⏻ (Standby/On)
- 2 F (Function)  
Selects the function and input source.
- 3 -/+ (Volume)  
Adjusts volume level.
- 4 Standby LED  
It lights up in red on standby mode.
- 5 Remote sensor

- 6 Function LED

**! Note**

- You can check current function through the LED.

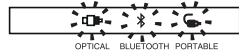

- This unit turns off LED if there is no key input for 20 seconds. To display LED, press any button.
- Standby LED quickly blinks when you press any button, and slowly blinks in Mute or Minimum volume status.
- **Bluetooth** LED blinks when you select **Bluetooth** function. If you connect **Bluetooth** device, LED will turn on.

- 7 Speakers

# Rear panel

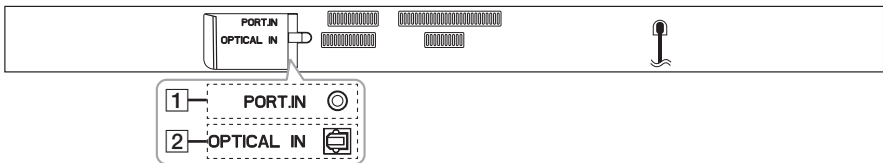

- 1 PORT. IN : Portable input

- 2 OPTICAL IN : Optical input

## Installing the sound bar

You can hear the sound by connecting the unit to the other device : TV, Blu-ray disc player, DVD player, etc.

Place the unit in front of the TV and connect it to the device you want. (Refer to pages 11 - 12.)

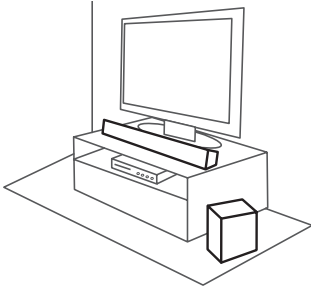

### ! Caution

- For best performance of wireless connection such as Bluetooth or wireless subwoofer, do not install the unit on Metallic furniture because wireless connection communicates through a module positioned on the bottom of the unit.
- Be careful not to make scratches on the surface of the Unit /Sub-Woofer when installing or moving them.

# Mounting the main unit on a wall

You can mount the main unit on a wall.

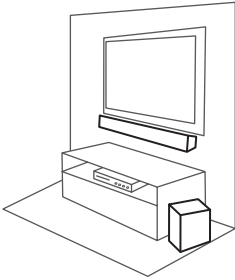

### Caution

Because it is difficult to make a connection after installing this unit, you should connect the cables before installation.

## Prepare screws and brackets.

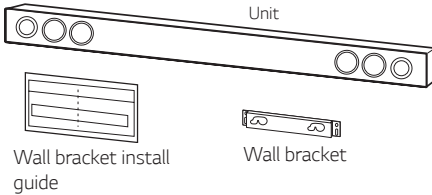

1. Match the TV's BOTTOM EDGE of Wall bracket install guide with the bottom of TV and attach to the position.

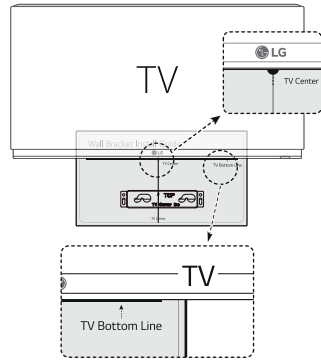

2. When you mount it on a wall (concrete), use the wall plugs (Not supplied). You should drill some holes. A guide sheet (Wall Bracket Install guide) is supplied to drill. Use the sheet to check the point to drill.

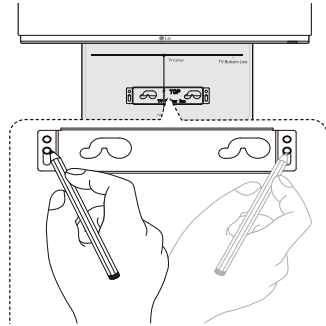

### Note

Screws and Wall Plugs are not supplied for mounting the unit. We recommend the Hilti (HUD-1 6 x 30) for the mounting.

3. Remove the Wall bracket install guide.

4. Fix it with screws (not supplied) as shown in the illustration below.

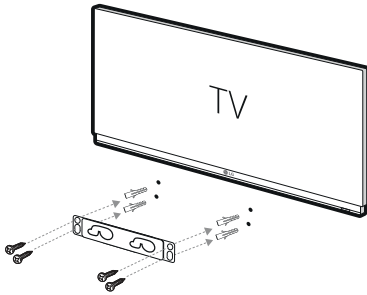

5. Hang the main unit onto the bracket as shown below.

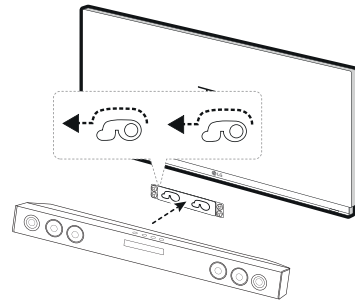

#### ⚠ Caution

- Do not install this unit upside down. It can damage the parts of this unit or be the cause of personal injury.
- Do not hang onto the installed unit and avoid any impact to the unit.
- Secure the unit firmly to the wall so that it does not fall off. If the unit falls off, it may result in an injury or damage to the product.
- When the unit is installed on a wall, please make sure that a child does not pull any of connecting cables, as it may cause it to fall.

#### ! Note

Detach the unit from the bracket as shown below.

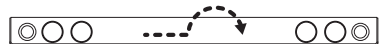

# Wireless subwoofer connection

## LED indicator of wireless subwoofer

LED Color	Status
Yellow-green (Blink)	The connection is trying.
Yellow-green	The connection is completed.
Red	The wireless subwoofer is in standby mode or the connection is failed.
Off (No display)	The power cord of wireless subwoofer is disconnected.

## Setting up the wireless subwoofer for the first time

1. Connect the power cord of the wireless subwoofer to the outlet.
2. Turn on the main unit : The main unit and wireless subwoofer will be automatically connected.

## Manually pairing wireless subwoofer

When your connection is not completed, you can see the red LED or the blinking of yellow-green LED on the wireless subwoofer and the subwoofer does not make sound. To solve the problem, follow the below steps.

1. Adjust volume level of the main unit to minimum by pressing VOL — button repeatedly until standby LED on the main unit blinks slowly.
2. Press and hold  (Mute) on the remote control for about 3 seconds.
  - The standby LED on the main unit blinks quickly.

3. If the LED of the wireless subwoofer already blinks in yellow-green continually, you can skip this step.

Press and hold **PAIRING** on the back of the wireless subwoofer for more than 5 seconds.



- The LED of the wireless subwoofer lights up alternately in red and yellow-green.
4. Disconnect the power cord of the main unit and the wireless subwoofer.
  5. Connect them again after the LED of the main unit and the wireless subwoofer is fully turned off.

The main unit and the wireless subwoofer will be paired automatically when you turn on the main unit.

- When the connection is completed, you can see the yellow-green LED on the subwoofer.

### Note

- It takes a few seconds (and may take longer) for the main unit and the subwoofer to communicate with each other and make sounds.
- The closer the main unit and the subwoofer, the better sound quality. It is recommended to install the main unit and the subwoofer as close as possible and avoid the cases below.
  - There is an obstacle between the main unit and the subwoofer.
  - There is a device using same frequency with this wireless connection such as a medical equipment, a microwave or a wireless LAN device.

## Connecting to your TV

Please connect with this unit and TV using the optical digital cable or HDMI cable considering the state of the TV.

### Using an OPTICAL cable

1. Connect the OPT. IN jack on the back of the unit to OPTICAL OUT jack on the TV using an OPTICAL cable.

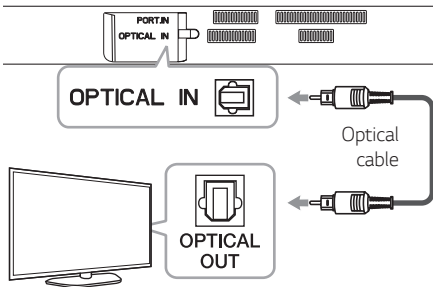

2. Set the input source to OPTICAL. Press **F** button repeatedly until the function is selected.

### Note

- Before connecting the optical cable, be sure to remove the protection plug cover if your cable has the cover.
- You can enjoy the TV audio through the speakers of this unit. In the case of some TV models, you must select the external speaker option from the TV menu. (For details, reference your TV user manual.)
- Set up the sound output of TV to listen to the sound through this unit :  
TV setting menu → [Sound] → [TV Sound output] → [External speaker (Optical)]
- Details of TV setting menu vary depending on the manufacturers or models of your TV.

## Optional equipment connection

### OPTICAL IN connection

Connect an optical output jack of external devices to the OPTICAL IN jack.

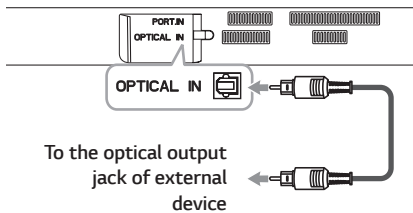

1. Connect the OPTICAL IN jack on the back of the unit to optical out jack of your TV (or digital device etc.)
2. Select the input source to OPTICAL by pressing **F** button repeatedly until the function is selected.
3. Listen to sound.
4. Press **F** to exit from OPTICAL.

#### ! Note

- Before connecting the optical cable, be sure to remove the protection plug cover if your cable has the cover.

### PORTABLE IN connection

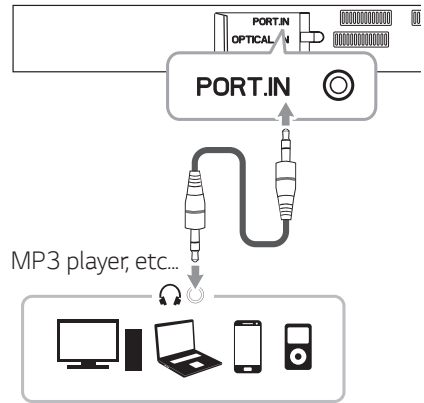

### Listening to music from your portable player

The unit can be used to play the music from many types of portable players or external devices.

1. Connect the portable player to the PORTABLE IN connector of the unit by using 3.5 mm stereo cable.
2. Turn the power on by pressing **⏻** (Power).
3. Select the PORTABLE function by pressing **F** button repeatedly until the function is selected.
4. Turn on the portable player or external device and start playing it.

# Operations

## DRC (Dynamic Range Control)

Make the sound clear when the volume is turned down and prevent sudden increase of sound (Dolby Digital only). This function turns on or off you press **DRC ON/OFF**.

## Turn off the sound temporarily

Press  (Mute) to mute your unit.

To cancel it, press  (Mute) again on the remote control or change the volume level.

## Using your TV remote control

You can control some functions of this unit by your TV remote control even by other company's product. Controllable functions are volume up/down and mute.

Press and hold **DRC ON** on the remote control for about 3 seconds.

To turn off this function, press and hold **DRC OFF** about 3 seconds.

### Note

- Supported TV brands

LG	Panasonic	Philips	Samsung
Sharp	Sony	Toshiba	Vizio

- Make sure that the sound output of your TV is set to [External speaker].
- Depending on the remote control, this function may not work well.

## Auto power down

This unit will be off itself to save electric consumption in the case main unit is not connected to external device and is not used for 20 minutes.

So does this unit after six hours since Main unit has been connected to other device using analogue input. (Ex : Portable, etc.)

## How to disconnect the wireless network connection or the wireless device

Set up the **AUTO POWER ON/OFF** function to off and turn off the unit.

## AUTO POWER On/Off

This unit automatically turns on by an input source : Optical or **Bluetooth**.

When you turn on your TV or an external device connected to this unit, this unit recognizes the input signal and select the suitable function. You can hear the sound from your device.

If you try to connect your **Bluetooth** device, this unit turns on and the unit will be connected your **Bluetooth** device.

This function turns on or off each time you press **AUTO POWER**.

### ! Note

- After the unit is turned on by AUTO POWER function, it will be automatically turned off if there is no signal for a certain period of time from the external device.
- If you turned off the unit directly, it cannot be turned on automatically by AUTO POWER function. However the unit can be turned on by AUTO POWER function when optical signal comes in after 5 seconds of no signal.
- Depending on the connected device, this function may not operate.
- If you disconnect **Bluetooth** connection by this unit, some **Bluetooth** devices try to connect to the unit continually. Therefore it is recommended to disconnect the connection before turn off the unit.
- When you turn on this unit for the first time, Auto Power function is turned on status.
- To use this function, the main unit must be registered in paired devices list of **Bluetooth** device.

## Auto function change

This unit recognizes input signals such as optical and **Bluetooth**. And then changes suitable function automatically.

### When optical signal comes in

When you turn on the external device connected to this unit by an optical cable, this unit change the function to optical. You can hear the sound from your device.

### When you try to connect BLUETOOTH device

When you try to connect your **Bluetooth** device to this unit, **Bluetooth** function is selected. Play your music on the **Bluetooth** device.

### ! Note

- To change to optical function, it needs 5 seconds of no signal.

# Using BLUETOOTH® technology

## About BLUETOOTH

**Bluetooth** is wireless communication technology for short range connection.

The sound may be interrupted when the connection interfered by the other electronic wave or you connect the **Bluetooth** in the other rooms.

Connecting individual devices under **Bluetooth** wireless technology does not incur any charges. A mobile phone with **Bluetooth** wireless technology can be operated via the Cascade if the connection was made via **Bluetooth** wireless technology.

Available Devices : Mobile phone, MP3, Laptop, PDA etc.

## BLUETOOTH Profiles

In order to use **Bluetooth** wireless technology, devices must be able to interpret certain profiles. This unit is compatible with following profile.

A2DP (Advanced Audio Distribution Profile)

Codec : SBC

## Listening to music stored on the BLUETOOTH devices

### Pairing your unit and BLUETOOTH device

Before you start the pairing procedure, make sure the **Bluetooth** feature is turned on in to your **Bluetooth** device. Refer to your **Bluetooth** device's user guide. Once a pairing operation is performed, it does not need to be performed again.

1. Turn on the unit.
2. Operate the **Bluetooth** device and perform the pairing operation. When searching for this unit with the **Bluetooth** device, a list of the devices found may appear in the **Bluetooth** device display depending on the type of **Bluetooth** device. Your unit appears as "LG LAS453B (XX)";

#### ! Note

- XX means the last two digits of **Bluetooth** address. For example, if your unit has a **Bluetooth** address such as 9C:02:98:4A:F7:08, you will see "LG LAS453B (08)" on your **Bluetooth** device.
- Depending on the **Bluetooth** device type, some device have a different pairing way. Enter the PIN code (0000) as needed.

3. When this unit is successfully connected with your Bluetooth device, BLUETOOTH (✳) LED will turned on.
4. Listen to music.  
To play a music stored on your **Bluetooth** device, refer to your **Bluetooth** device's user guide.

### ! Note

- When using **Bluetooth** technology, you have to make a connection between the unit and the **Bluetooth** device as close as possible and keep the distance.  
However it may not work well in the case below :
  - There is an obstacle between the unit and the **Bluetooth** device.
  - There is a device using same frequency with **Bluetooth** technology such as a medical equipment, a microwave or a wireless LAN device.
- You should connect your **Bluetooth** device to this unit again when you restart it.
- The sound may be interrupted when the connection is interfered by the other electronic wave.
- You may not control the **Bluetooth** device with this unit.
- Pairing is limited to one Bluetooth device per one unit and multi-pairing is not supported.
- Depending on the type of the device, you may not be able to use the **Bluetooth** function.
- You can enjoy Bluetooth function using Smart phone, MP3 player, Notebook, etc..
- The more distance between the unit and the **Bluetooth** device, the lower the sound quality becomes.
- **Bluetooth** connection will be disconnected when the unit is turned off or the **Bluetooth** device gets far from the unit.
- When **Bluetooth** connection is disconnected, connect the **Bluetooth** device to the unit again.
- When not connected to the **Bluetooth**, **Bluetooth** LED will blink.

## Sound adjustment

### Setting sound effect

This system has a number of pre-set surround sound fields. You can select a desired sound mode by using each sound mode button.

The displayed items for the equalizer may be different depending on sound sources and effects.

Button	Description
STANDARD	You can enjoy optimized sound.
CINEMA	You can enjoy more immersive and cinematic surround sound.
VOICE	This program makes voice sound clear, improving the quality of voice sound.

### ! Note

- In some sound effect modes, some speakers, there's no sound or low sound. It depends on the mode of surround and the source of audio, it is not defective.
- You may need to reset the sound effect mode, after switching the input, sometimes even after the sound file changed.

### Adjust the woofer level settings

You can adjust the sound level of the woofer by pressing the WOOFER LEVEL **+/-** button.

# Troubleshooting

PROBLEM	CAUSE & CORRECTION
The unit does not work properly.	<ul style="list-style-type: none"> <li>• Turn off the power of this unit and the connected external device (TV, Woofer, DVD-player, Amplifier, etc.) and turn it on again.</li> <li>• Disconnect the power cord of this unit and the connected external device (TV, Woofer, DVD-player, Amplifier, etc.) and then try connecting again.</li> <li>• Previous setting may not be saved when device power is shut off.</li> </ul>
No Power	<ul style="list-style-type: none"> <li>• The power cord is unplugged. Plug in the power cord.</li> <li>• Check the condition by operating other electronic devices.</li> </ul>
No sound	<ul style="list-style-type: none"> <li>• Incorrect input source is selected. Check the input source and select the correct input source.</li> <li>• The mute function is activated. Press  (Mute) or adjust the volume level to cancel the mute function.</li> <li>• When you are using connection with a external device (set top box, <b>Bluetooth</b> device etc.), adjust volume level of the device.</li> </ul>
No woofer sound	<ul style="list-style-type: none"> <li>• The power cord of the subwoofer is not connected. Plug the power cord into the wall outlet securely.</li> <li>• Pairing between the unit and the subwoofer gets disconnected. Connect the unit and the subwoofer. (Refer to the page 9.)</li> </ul>
The remote control does not work properly.	<ul style="list-style-type: none"> <li>• The remote control is too far from the unit. Operate the remote control within about 7 m.</li> <li>• There is an obstacle in the path of the remote control and the unit. Remove the obstacle.</li> <li>• The batteries in the remote control is exhausted. Replace the batteries with new one.</li> </ul>
The AUTO POWER function does not work.	<ul style="list-style-type: none"> <li>• Check connection of the external device such as TV, DVD/Blu-Ray player or <b>Bluetooth</b> device.</li> <li>• Depending on the connected device, this function may not operate.</li> </ul>

PROBLEM	CAUSE & CORRECTION
<p>When you feel the output sound of the unit is low.</p>	<p>Check the details below and adjust the unit according to them.</p> <ul style="list-style-type: none"> <li>• Switch [ON] state of DRC function to [OFF] by using remote controller.</li> <li>• With the sound bar connected with TV, change the AUDIO DIGITAL OUT setting on TV Setup Menu from [PCM] to [AUTO] or [BITSTREAM].</li> <li>• With the sound bar connected with Player, change the AUDIO DIGITAL OUT setting on Player Setup Menu from [PCM] to [PRIMARY PASS-THROUGH] or [BITSTREAM].</li> <li>• Change Audio DRC setting on Player setup menu to [OFF] state.</li> </ul>

## NOTES to use wireless

PROBLEM	CAUSE & CORRECTION
<p>This device may have wireless interference.</p>	<ul style="list-style-type: none"> <li>• Wireless may not operate normally in weak signal area.</li> <li>• Please install the device close enough to wireless subwoofer.</li> <li>• Do not install the device on metal furniture for optimum performance.</li> </ul>
<p>Bluetooth device may malfunction or make noise in the following cases.</p>	<ul style="list-style-type: none"> <li>• When any part of your body contact the transceiver of the <b>Bluetooth</b> device or sound bar.</li> <li>• When there is an obstacle or wall or the device is installed in a secluded spot.</li> <li>• When there is a device(a wireless LAN, a medical equipment or a microwave) using same frequency, make the distance between the products as far away as possible each other.</li> <li>• When to connecting the device to the <b>Bluetooth</b> device, make the distance between the products as close as possible each other.</li> <li>• When the device gets too far from the <b>Bluetooth</b> device, the connection is disconnected and also malfunction may occur.</li> </ul>

---

## Trademarks and licenses

All other trademarks are trademarks of their respective owners.

---



Manufactured under license from Dolby Laboratories. Dolby and the double-D symbol are trademarks of Dolby Laboratories.

---



For DTS patents, see <http://patents.dts.com>.  
Manufactured under license from DTS Licensing Limited. DTS, the Symbol, & DTS and the Symbol together are registered trademarks, and DTS Digital Surround is a trademark of DTS, Inc. © DTS, Inc. All Rights Reserved.

---



**Bluetooth** wireless technology is a system which allows radio contact between electronic.

Connecting individual devices under **Bluetooth** wireless technology does not incur any charges. A mobile phone with **Bluetooth** wireless technology can be operated via the Cascade if the connection was made via **Bluetooth** wireless technology.

The **Bluetooth** word mark and logos are owned by the Bluetooth SIG, Inc. and any use of such marks by LG Electronics is under license.

Other trademarks and trade names are those of their respective owners.

---

# Specifications

General	
Power requirements	Refer to the main label on the unit.
Power consumption	Refer to the main label on the unit.
	Networked standby : 0.5 W (If all network ports are activated.)
Dimensions (W x H x D)	Approx. 950 mm x 71 mm x 47 mm
Net Weight	Approx. 2.47 kg
Operating temperature	5 °C to 35 °C
Operating humidity	5 % to 90 %

Inputs	
Digital audio in (OPTICAL IN)	3 V (p-p), Optical jack x 1
Portable in (PORT. IN)	0.5 Vrms (3.5 mm stereo jack) x 1
Available Digital Input Audio Sampling Frequency	32 kHz, 44.1 kHz, 48 kHz, 88.2 kHz, 96 kHz
Available Digital Input Audio format	Dolby Digital, DTS Digital Surround, PCM

Amplifier (RMS Output power)	
Total	300 W
Front	50 W x 2 (4 $\Omega$ at 1 kHz, THD 10%)
Subwoofer	100 W (6 $\Omega$ at 80 Hz, THD 10%)

Wireless subwoofer	
Power requirements	Refer to the main label on the unit.
Power consumption	Refer to the main label on the unit.
Type	1 Way 1 Speaker
Impedance	3 $\Omega$
Rated Input Power	200 W
Max. Input Power	400 W
Dimensions (W x H x D)	Approx. 171 mm X 390 mm X 261 mm
Net Weight	Approx. 5.6 kg

- Designs and specifications are subject to change without prior notice.

# Maintenance

## Handling the unit

### When shipping the unit

Please save the original shipping carton and packing materials. If you need to ship the unit, for maximum protection, re-pack the unit as it was originally packed at the factory.

### Keeping the exterior surfaces clean

- Do not use volatile liquids such as insecticide spray near the unit.
- Wiping with strong pressure may damage the surface.
- Do not leave rubber or plastic products in contact with the unit for a long period of time.

### Cleaning the unit

To clean the player, use a soft, dry cloth. If the surfaces are extremely dirty, use a soft cloth lightly moistened with a mild detergent solution. Do not use strong solvents such as alcohol, benzine, or thinner, as these might damage the surface of the unit.

