

NANO79*

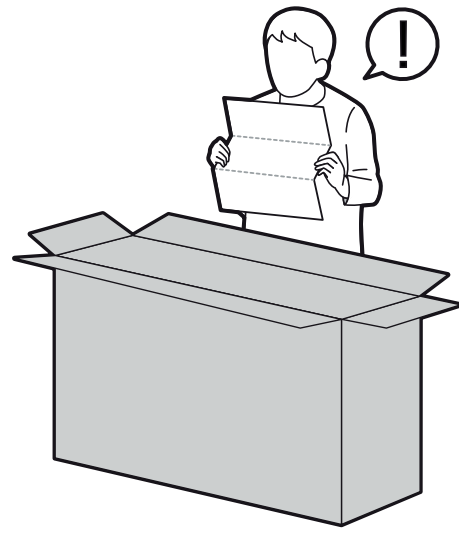

1
43/50/55NANO79*

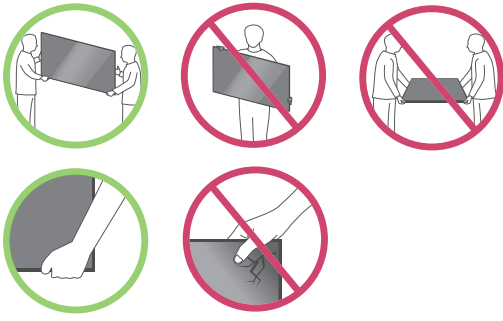
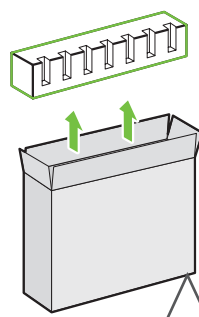

2

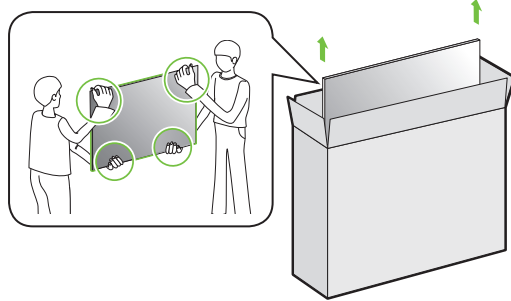

3

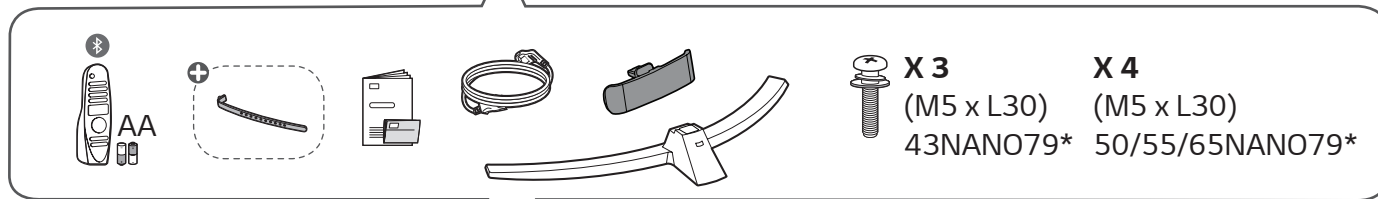
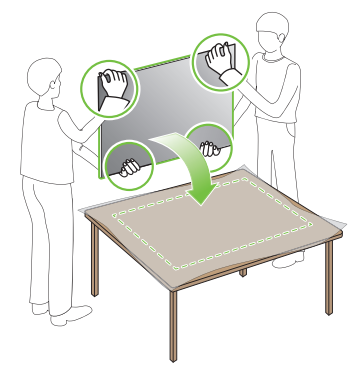

1
65NANO79*

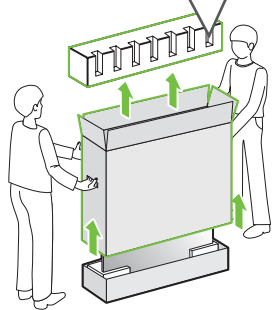

2

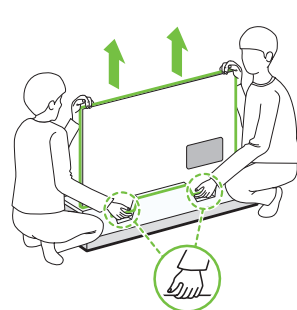

3

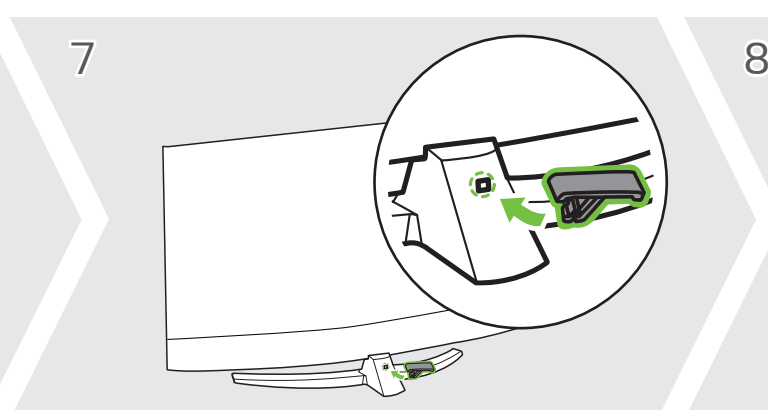
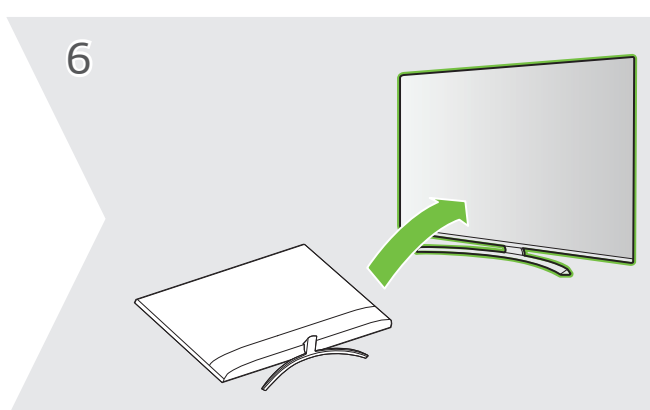
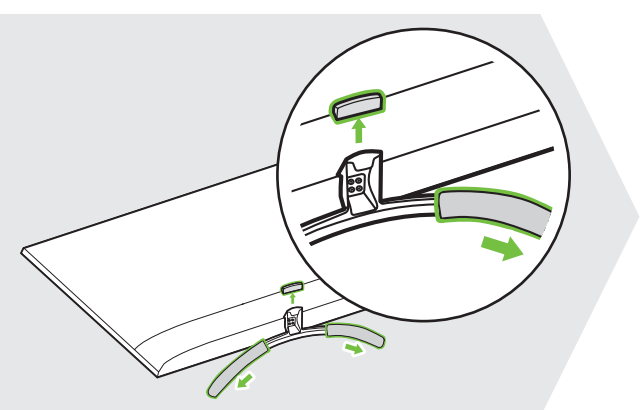
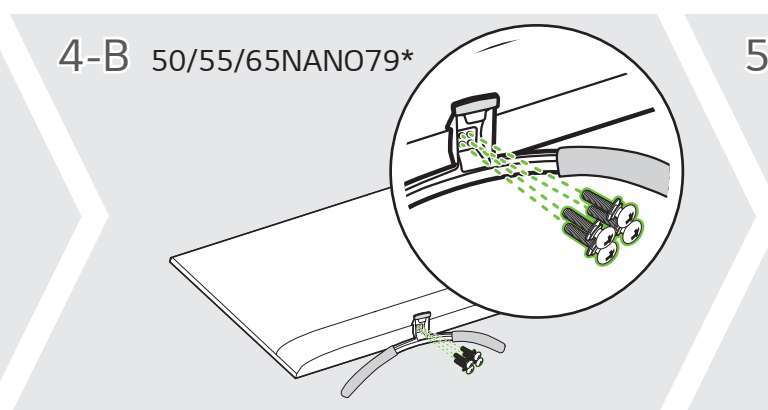
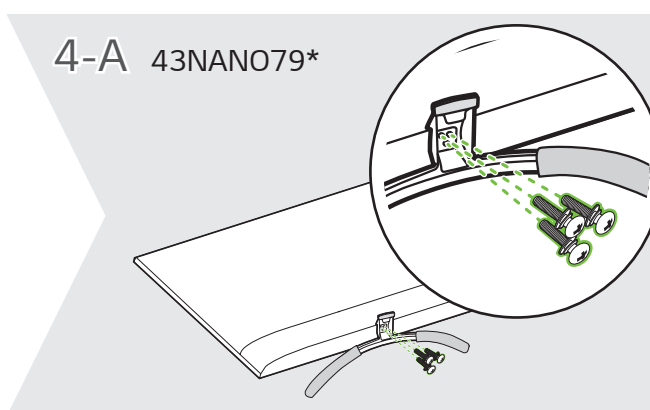
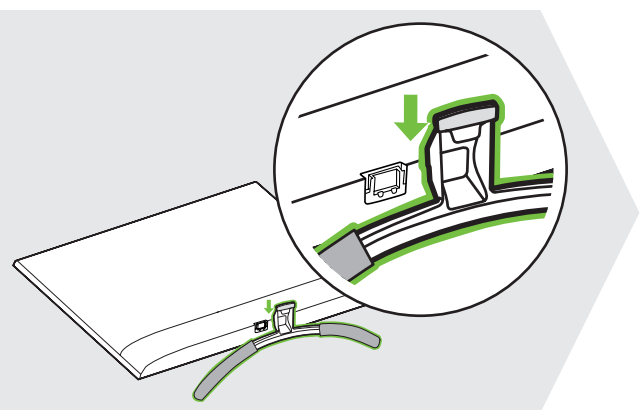
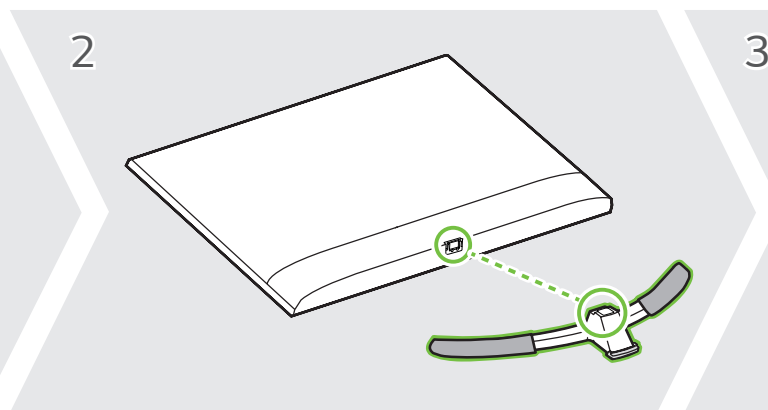
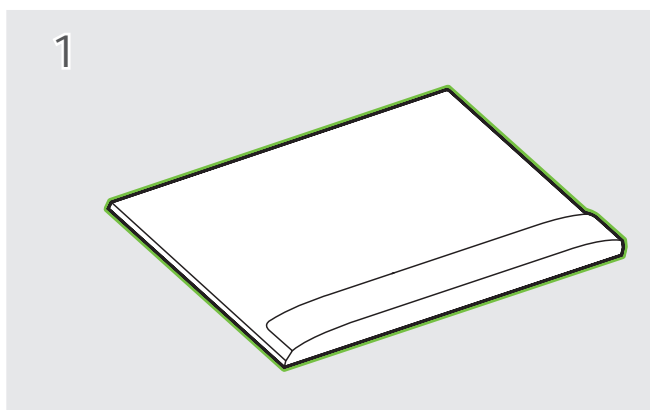
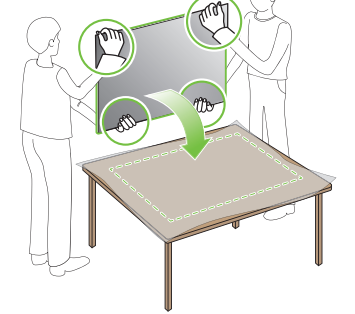

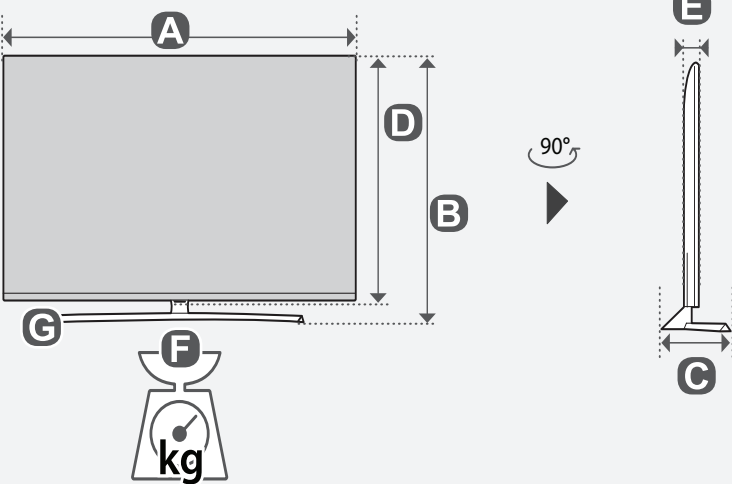
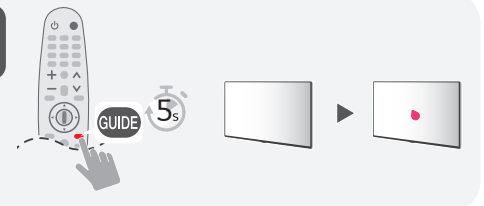
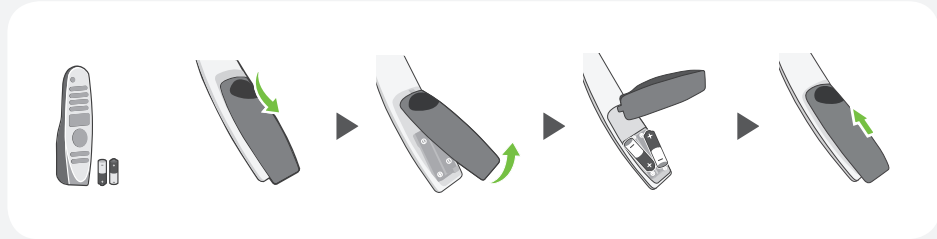
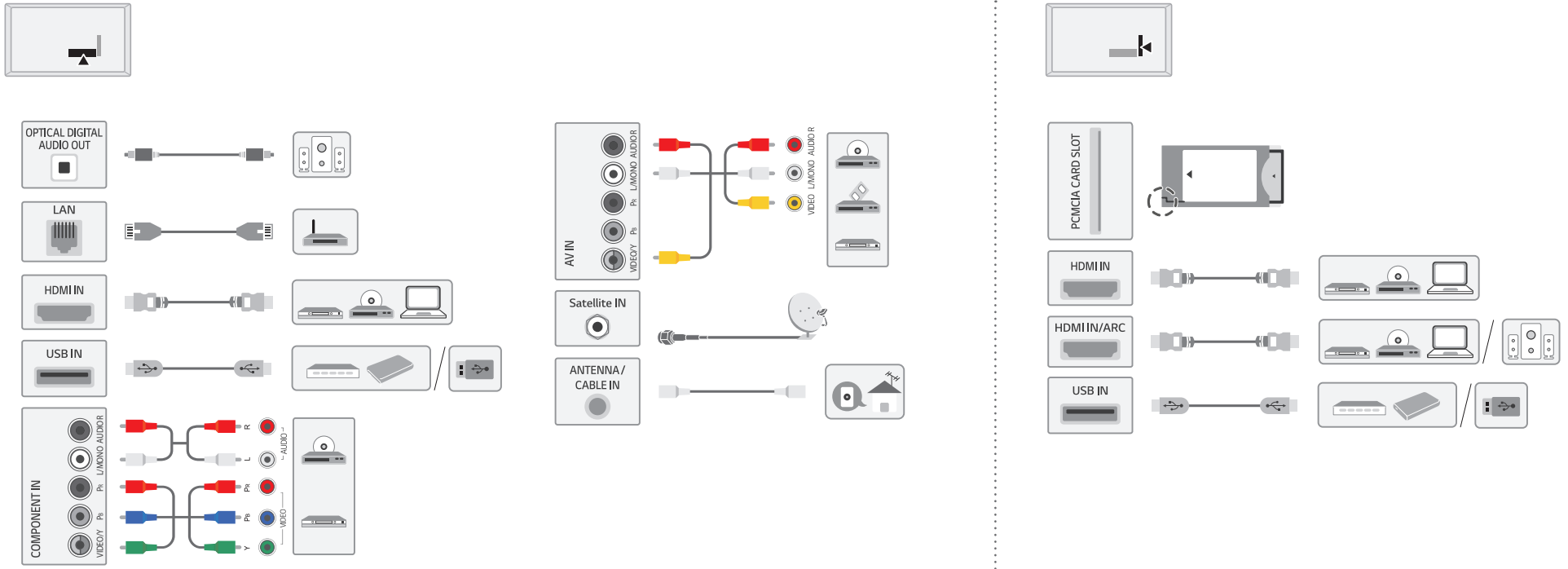

	A	B	C	D	E	F	F-G
	(mm)					(kg)	
43NANO796NE							
43NANO796NF	973	622	221	572	85.0	9.0	8.2
43NANO793NE							
50NANO796NE							
50NANO796NF	1130	728	260	663	86.3	12.5	11.5
50NANO793NE							
55NANO796NE							
55NANO796NF	1244	791	260	726	87.1	15.6	14.6
55NANO793NE							
65NANO796NE							
65NANO796NF	1463	914	340	850	87.8	22.4	21.4
65NANO793NE							
Power requirement / Güç gereksinimi / Alimentation / متطلبات الطاقة				AC 100-240 V ~ 50 / 60 Hz			



- English** • Read **Safety and Reference**.
- Türkçe** • **Güvenlik ve Referans** bölümünü okuyun.
- Français** • Lire le document **Sécurité et référence**.

العربية • قراءة الأمان والمرجع.

⊕ : Depending on model / Modele bağlı olarak değişiklik gösterebilir / Selon le modèle / حسب الطراز