

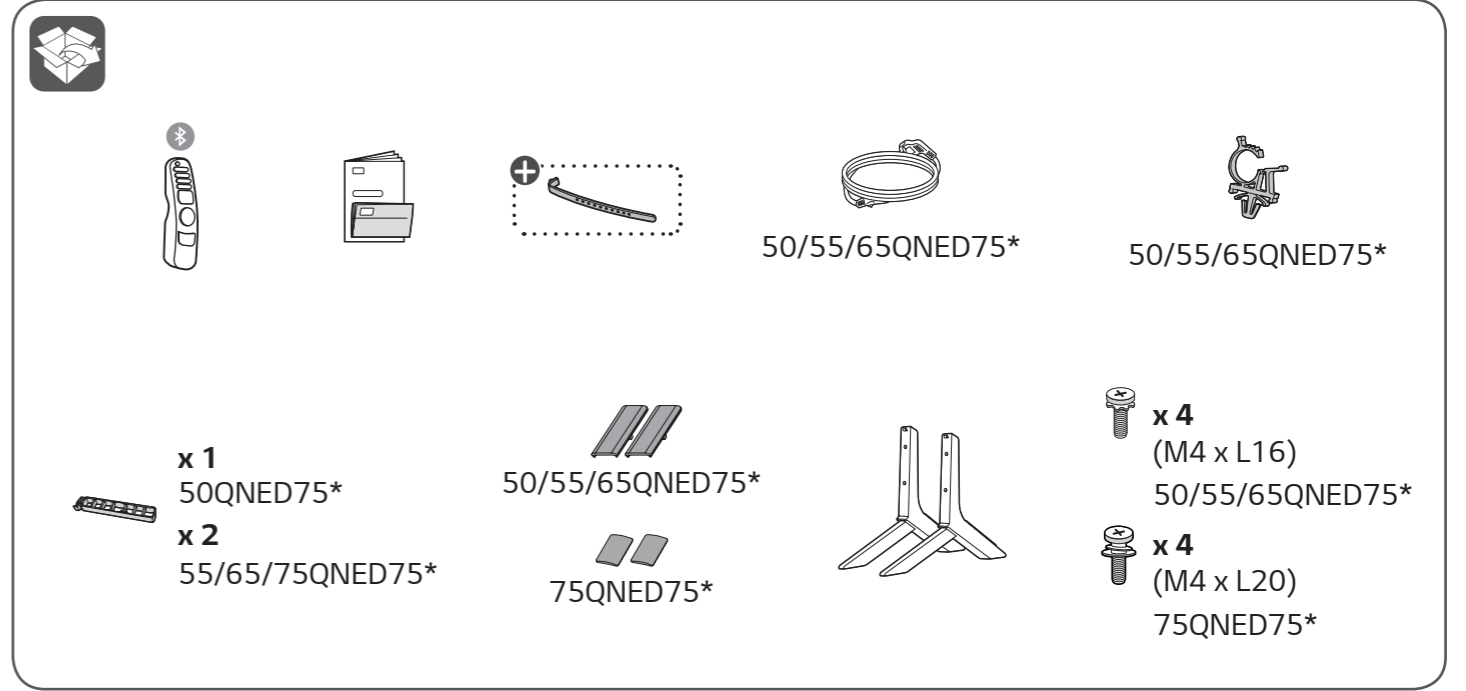

QNE75*



50QNE75*

1

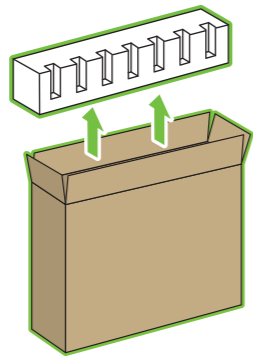

2

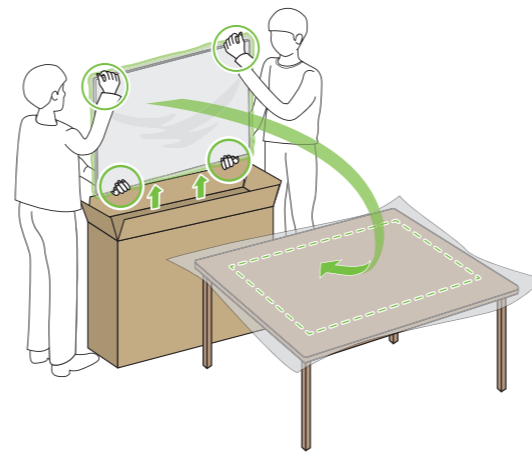

3

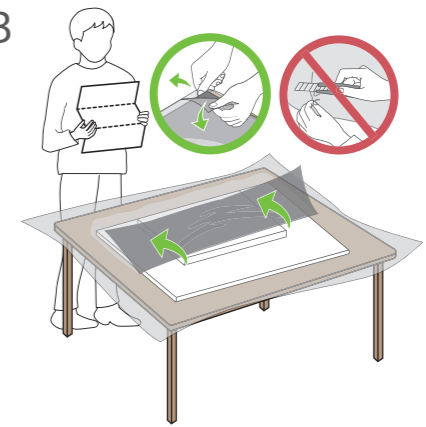

55QNE75*

A-1

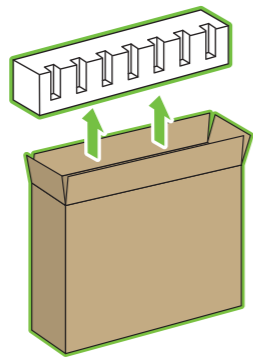

A-2

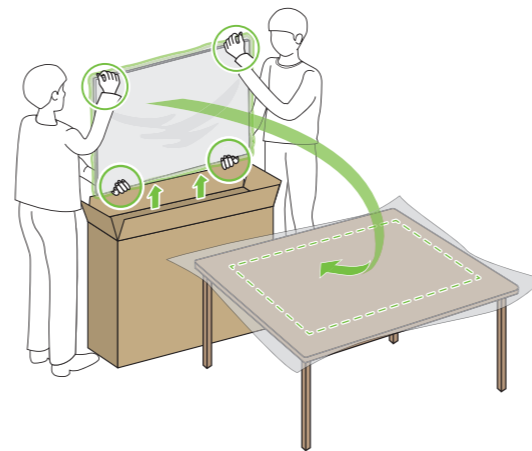

A-3

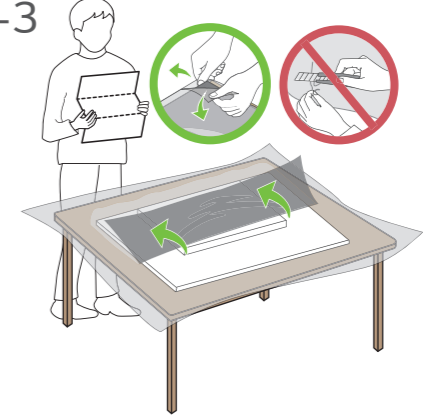

B-1

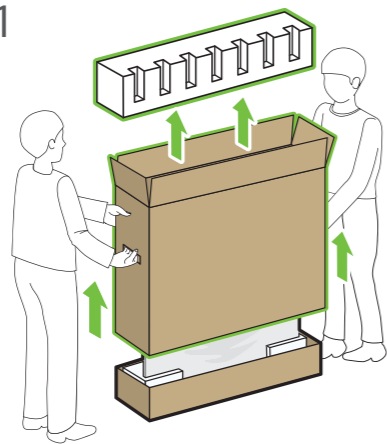

B-2

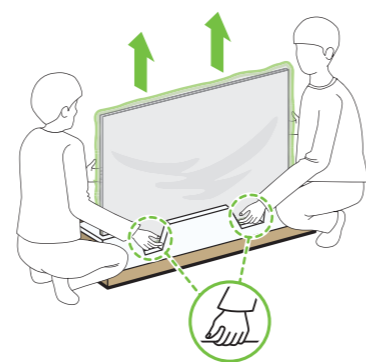

B-3

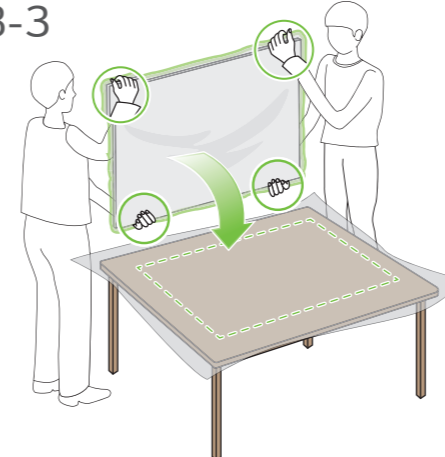

B-4

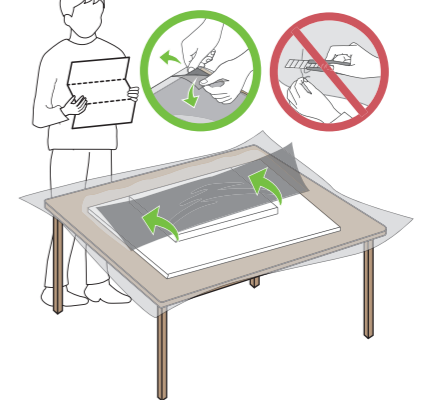

65/75QNE75*

1

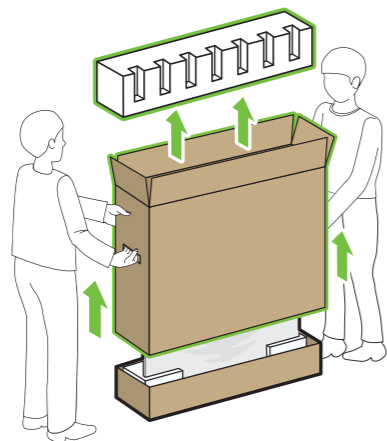

2

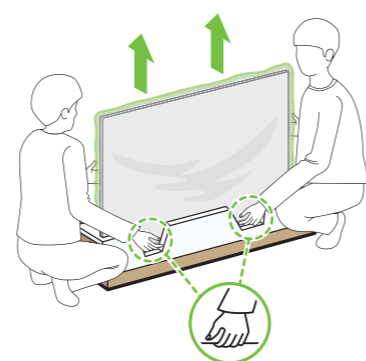

3

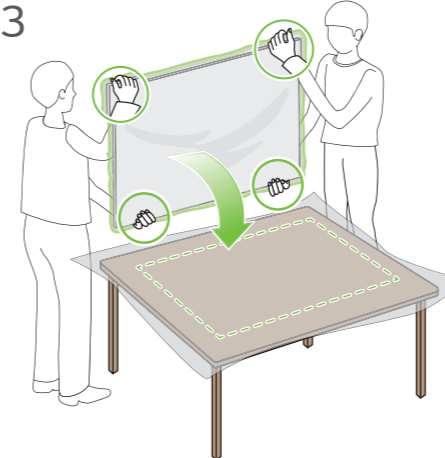

4

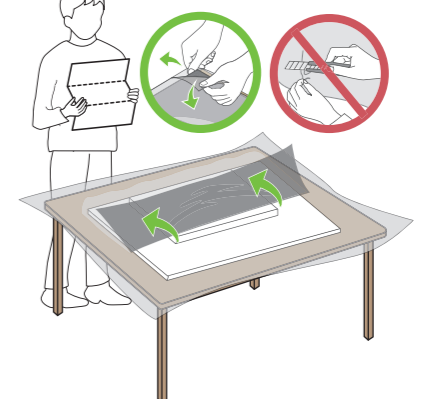

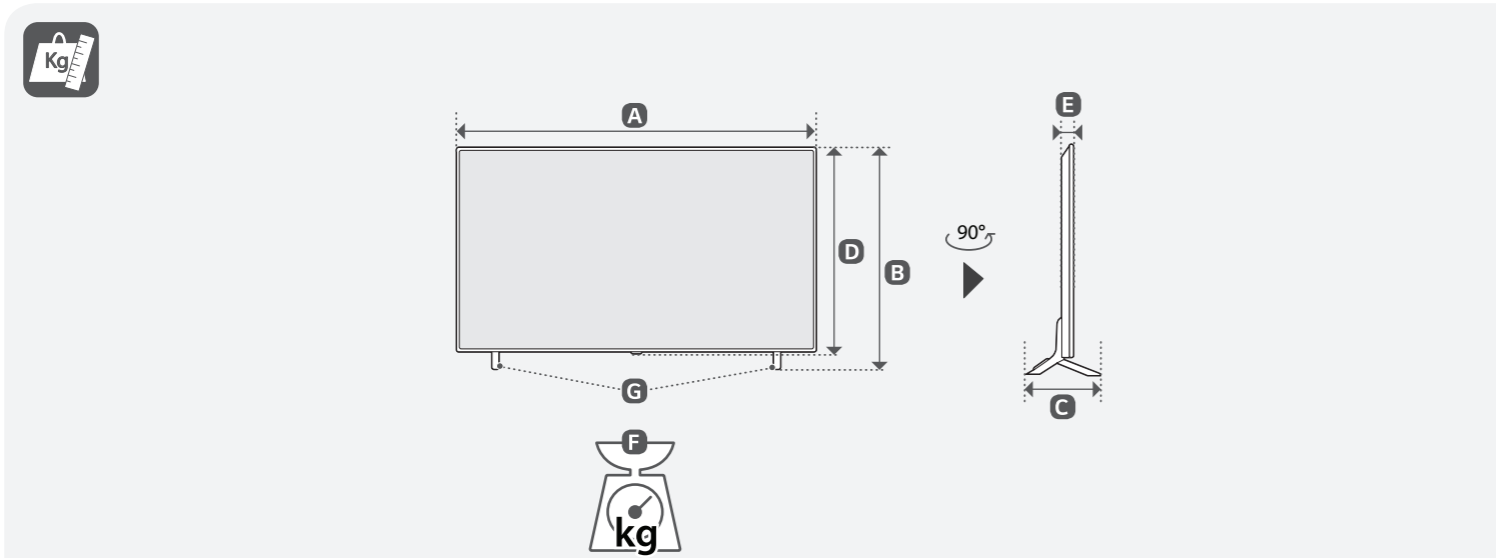
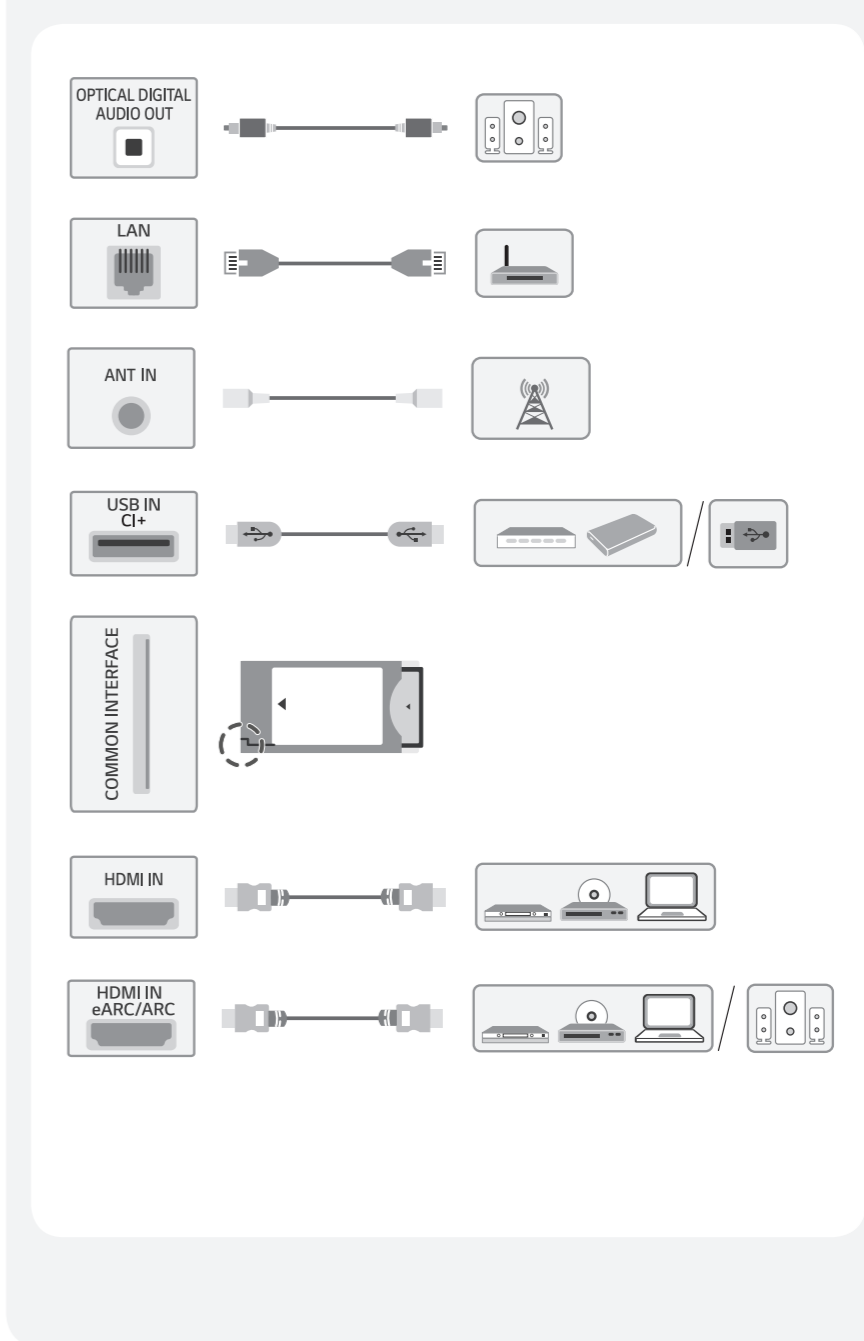
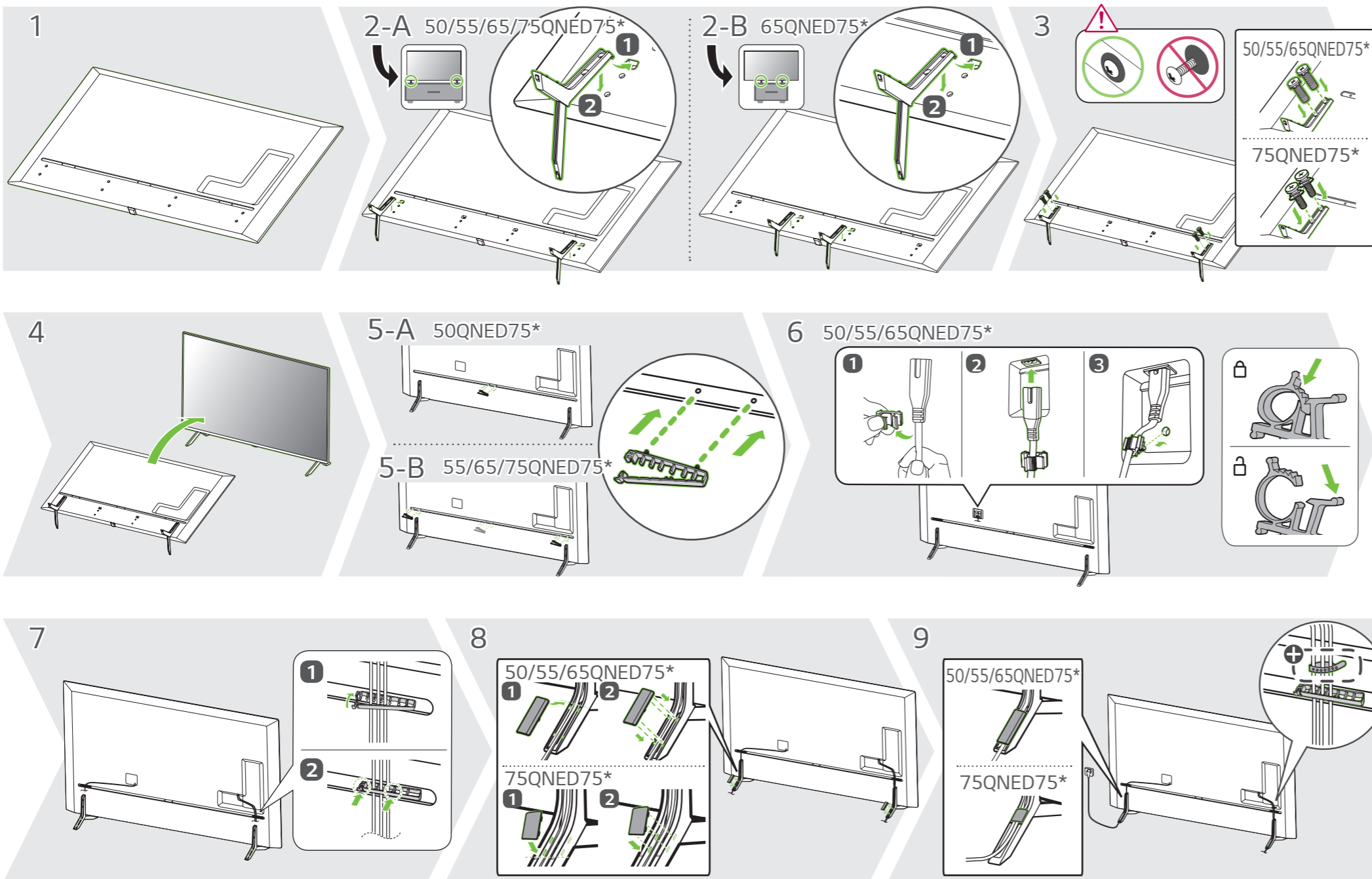

	A	B	C	D	E	F	F-G
	(mm)					(kg)	
50QNE753RA	1120	718	257	653	49.2	14.1	13.7
50QNE756RA							
55QNE753RA	1233	781	257	716	44.2	16.7	16.3
55QNE756RA							
65QNE753RA	1452	906	295	839	44.3	24.4	24.0
65QNE756RA							
75QNE753RA	1675	1029	359	964	44.5	36.5	35.5
75QNE756RA							

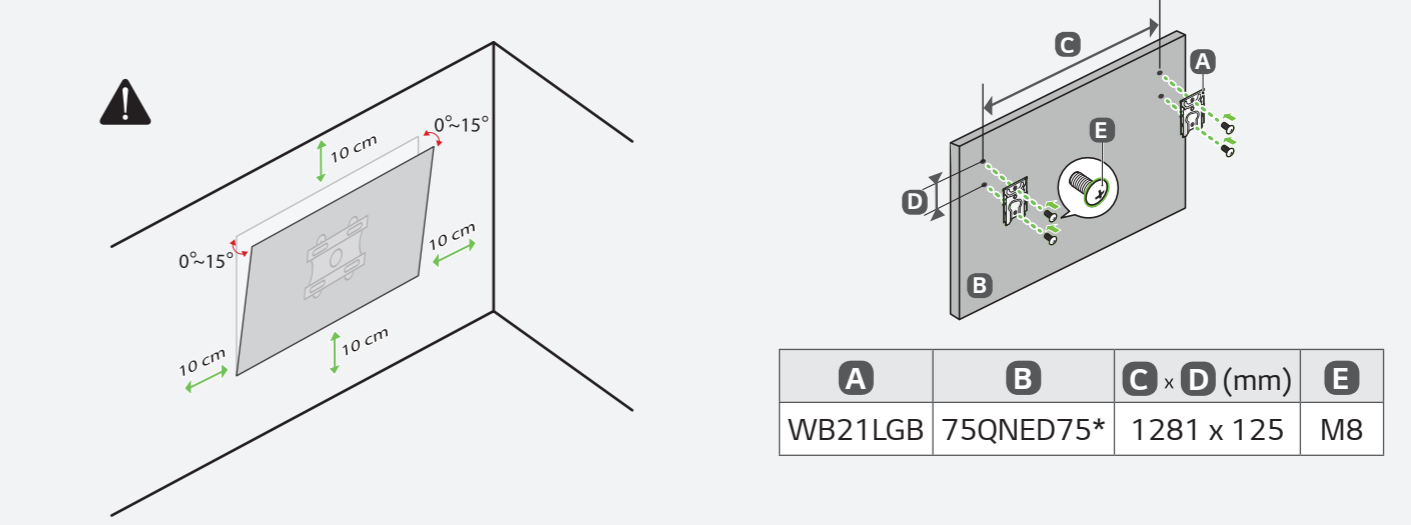
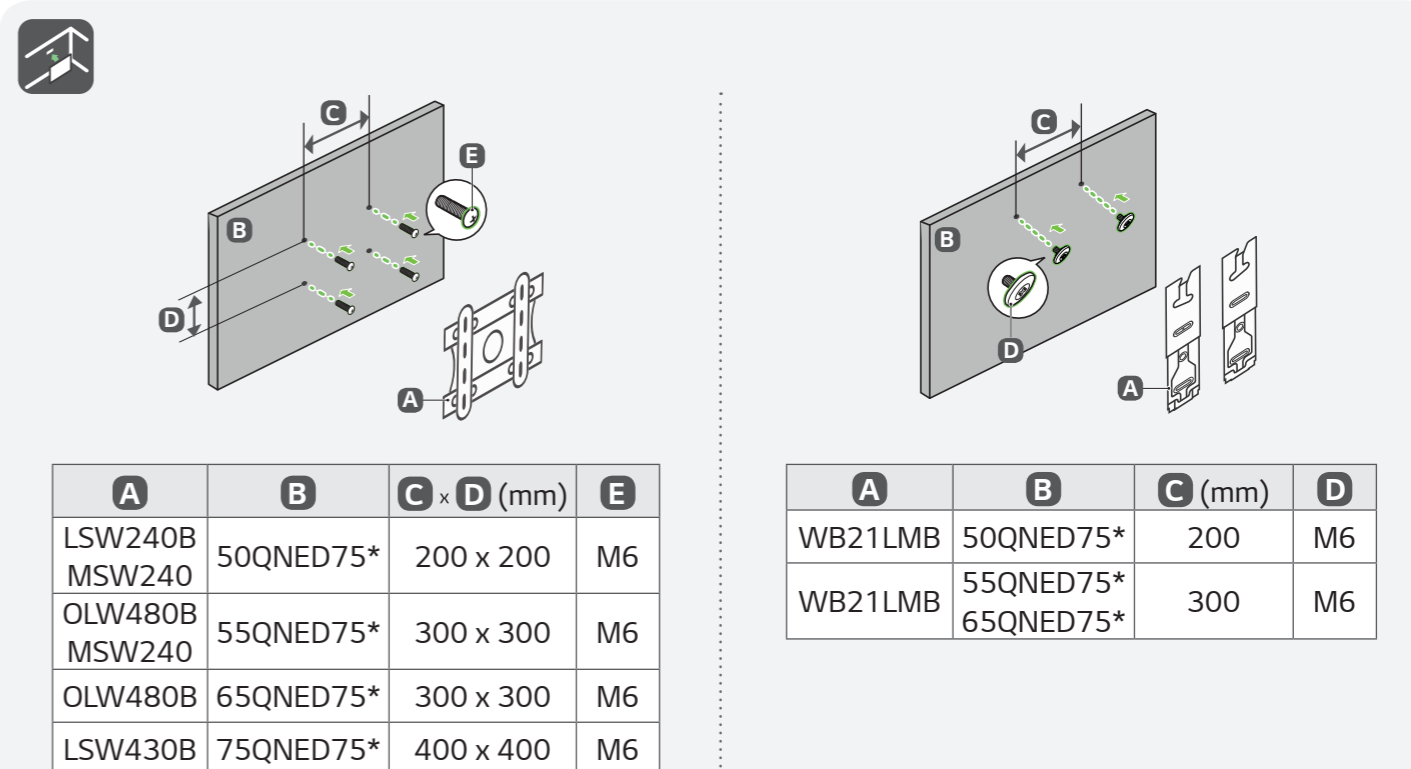

+ : Depending on model / Abhängig vom Modell / Selon le modèle / In base al modello / En función del modelo / Dependendo do modelo / Afhankelijk van het model / Av λογα με το μοντ λο / Odvisno od modela / Tipusfüggő / Zależnie od modelu / Závisí na modelu / V závislosti od modelu / În funcție de model / В зависимости от модели / Sõltub mudelist / Priklauso nuo modelio / Atkarībā no modeļa / U zavisnosti od modela / Ovisno o modelu / Në varësi të modelit / Ovisno o modelu / Во зависност од моделот / Beroende på modell / Avhengig av modell / Afhængigt af modellen / Mallin mukaan / В зависимости от модели / Залежно від моделі / Үлгіге байланысты / Rusumiga qarab / Загвараас хамаарна /
 Modele bağlı olarak değişkenlik gösterebilir