

- English • Read Safety and Reference.
- Русский • Прочтите Руководство по технике безопасности.
- Українська • Прочитайте "Правила безпеки та довідкова інформація".
- Қазақша • Қауіпсіздік нұсқаулығын оқыңыз.
- O'zbekcha • Xavfsizlik bo'yicha ko'rsatmalar va havolalar'ni o'qib chiqing.
- Монгол • Аюулгүй ажиллагааны зааварчилгааг уншина уу.

+ : Depending on model / В зависимости от модели / Залежно від моделі / Үлгіге байланысты / Rusumiga qarab / Загвараас хамаарна

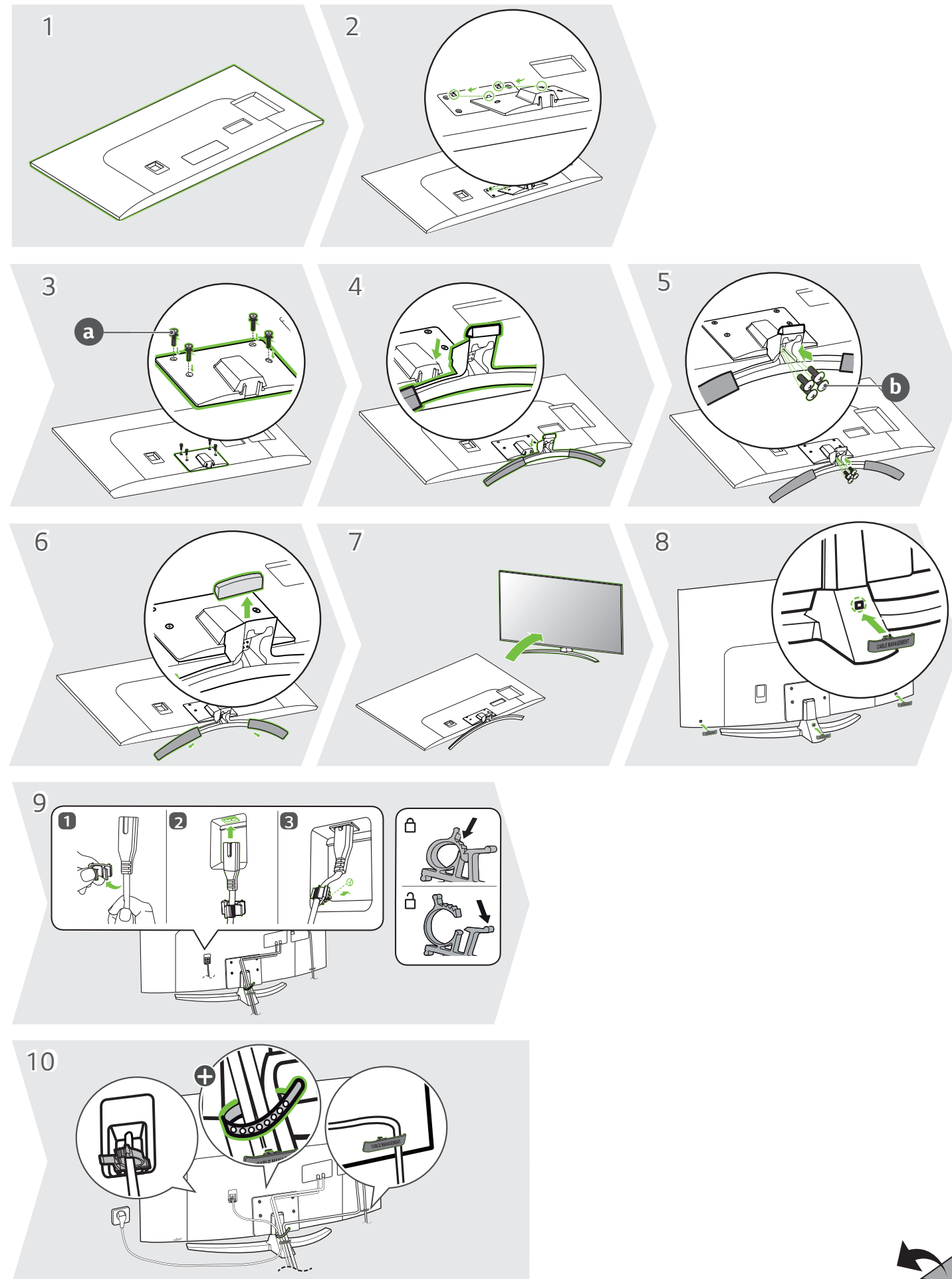

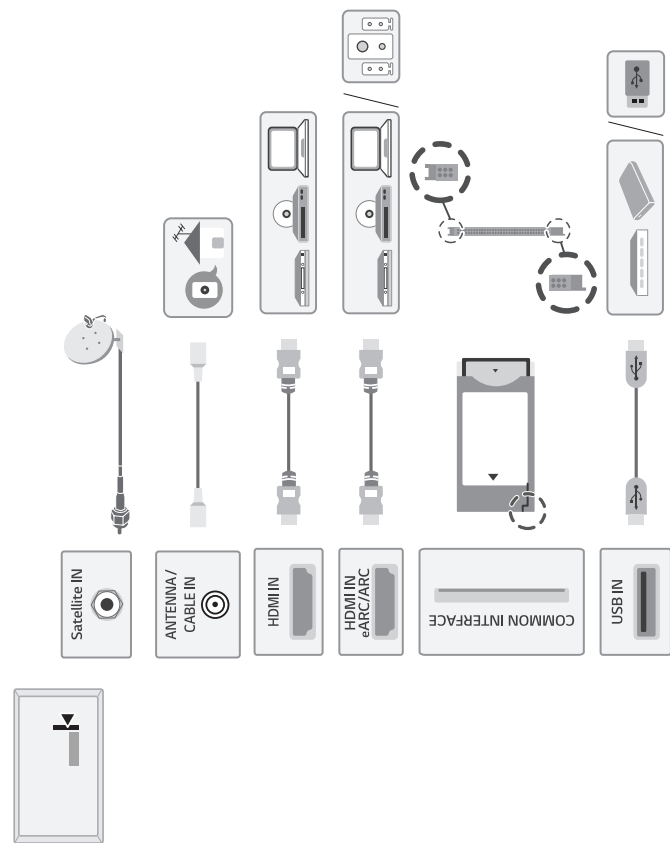

.....

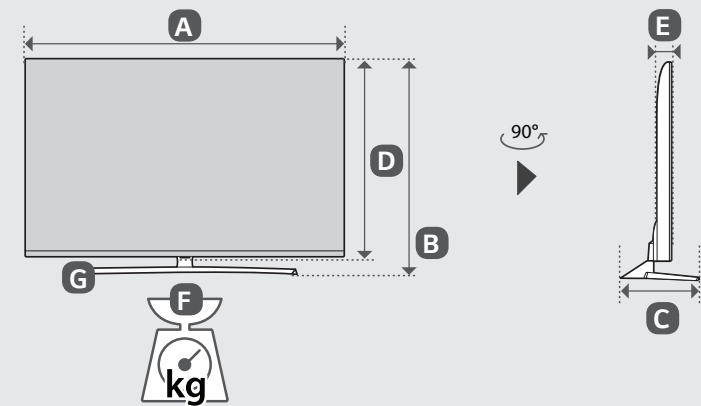
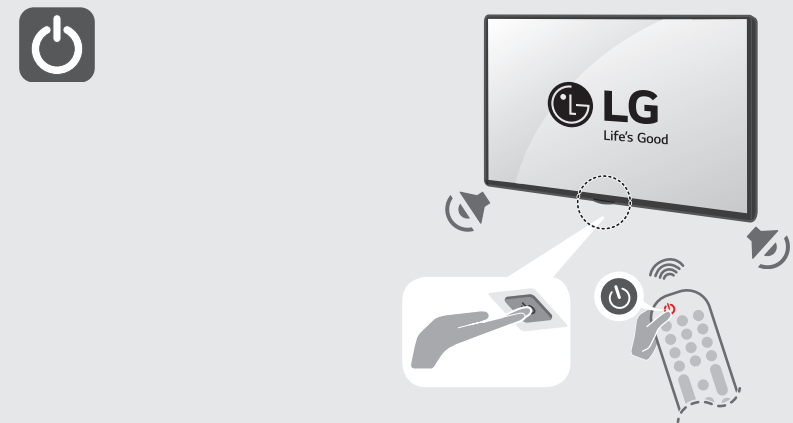
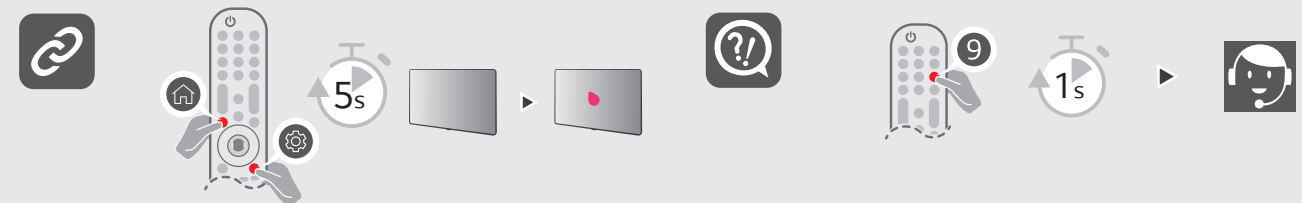
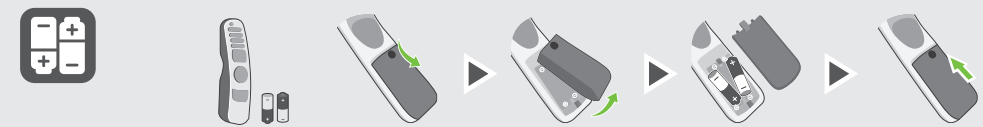
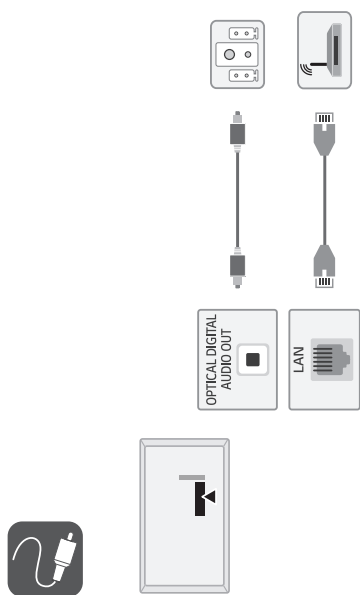

	A	B	C	D	E	F	F-G
	(mm)				(kg)		
55UP78003LB 55UP78006LB 55UP78006LC 55UP78009LB	1235	787	260	715	57.5	15.4	14.0
65UP78003LB 65UP78006LB 65UP78006LC 65UP78009LB	1454	909	340	838	57.7	22.9	21.5
Требования к электропитанию Вимоги до електроживлення Електротүтүну шарттары				AC 100-240 V ~ 50 / 60 Hz			