



OWNER'S MANUAL

LG Digital Signage

(Signage webOS Box)

Please read this manual carefully before operating your set and retain it for future reference.

WP320

www.lg.com

Copyright © 2018 LG Electronics Inc. All Rights Reserved.

TABLE OF CONTENTS

IMPORTANT PRECAUTIONS.....3

- Electrical Power Related Precautions.....3
- Precautions for installing the Product.....5
- Precautions for Moving the Product.....6
- Precautions for Using/Cleaning the Product....7
- Product Disposal (Only, Hg lamp used LCD Monitor).....7

LICENSES.....8

ASSEMBLY AND PREPARATION ..9

- Optional Accessories.....9
- Parts and Buttons.....10
- Installation.....11
- HDMI connections.....14

REMOTE CONTROL 15

USING THE WP320 SET 17

- Connecting to a PC.....17
- External Device Connection.....17
- Using the Input List.....17

TROUBLESHOOTING..... 18

PRODUCT SPECIFICATIONS..... 20

Warning: This equipment is compliant with Class A of CISPR 32. In a residential environment this equipment may cause radio interference.

IMPORTANT PRECAUTIONS

Please read these safety precautions carefully before using the product.

WARNING

Failure to follow those warnings may result in death, serious injury or damage to the product or other property.

CAUTION

If you ignore the caution message, you may be slightly injured or the product may be damaged.

WARNING

- Indoor Use Only.

Electrical Power Related Precautions

WARNING

- Use only the power cord supplied with the unit or another manufacturer's authorized cord.
 - Failure to do so may result in fire or electrical shock or damage to the product.
- Use only a properly grounded plug and receptacle.
 - If you do not you may be electrocuted or injured. Or the product might be damaged.
- Do not use a damaged or loose plug.
 - This may cause electrical shock or fire.
- Operate the display only from a power source(i.e. voltage) indicated in the product specification.
 - Otherwise the product can be damaged, fire can occur or you may be electrocuted. If you are not sure what type of power supply you have, consult a certified electrician.
- In the presence of thunder and lightning, never touch the power cord and signal cable because it can be very dangerous.
 - It can cause electric shock.
- Do not connect several extension cords, electrical appliances or electrical heaters to a single outlet. Use a power strip with a grounding terminal designed for exclusive use with the computer.
 - A fire can break out due to overheating.
- Do not touch the power plug with wet hands. Additionally, if the cord pin is wet or covered with dust, dry the power plug completely or wipe dust off before plugging in the cord.
 - You may be electrocuted due to excess moisture.

- If you don't intend to use the product for a long time, unplug the power cable from the product.
 - Layers of dust can cause a fire, or insulation deterioration can cause electric leakage, electric shock or fire.
- Insert the power plug firm so it cannot come loose.
 - A loose connection can cause fire.
- Hold the plug when pulling out the power cable. Do not pull the plug out by the wire. Do not bend the power cord with excessive force or put heavy objects on the power cord.
 - The power line can be damaged, which may cause electric shock or fire.
- Do not insert metal or other conductive materials into the product openings. Additionally, do not touch the power cable right after plugging into the wall input terminal.
 - You may be electrocuted.
- Use an appliance coupler as a disconnect device.
- Please make sure the device is installed near the wall outlet to which it is connected and that the outlet is easily accessible.
- Do not unplug the power cord while the product is in use.
 - Electrical shock can damage the product.
- As long as this unit is connected to the AC wall outlet, it is not disconnected from the AC power source even if the unit is turned off.

Precautions for installing the Product

WARNING

- Keep away from heat sources like heaters or open flames.
 - Electrical shock, fire, malfunction or deformation may occur.
- Keep the packing anti-moisture material or vinyl packing out of the reach of children.
 - Anti-moisture material is harmful if swallowed. If swallowed by mistake, force the patient to vomit and visit the nearest hospital. Additionally, vinyl packing can cause suffocation. Keep it out of the reach of children.
- Do not put heavy objects on the product or sit upon it.
 - If the product collapses or is dropped, you may be injured. Prevent Children from climbing or pulling on the unit.
- Do not leave the power or signal cable where someone can trip over it.
 - Pedestrians may become entangled in the cables and cause the device to become damaged causing electrical shock, fire, or serious injury.
- Install the product in a neat and dry place. Do not use near water.
 - Dust or moisture can cause electrical shock, fire or product damage.
- Do not add accessories that have not been designed for this display.
- If you smell smoke or other odors or hear a strange sound from the product unplug the power cord and contact LG Customer Service.
 - If you continue to use without taking proper measures, electrical shock or fire can occur.
- If you dropped the product or the case is broken, turn off the product and unplug the power cord.
 - If you continue to use without taking proper measures, electrical shock or fire can occur. Contact LG Customer Service.
- Do not drop an object on or apply impact to the product. Do not throw any toys or objects at the product.
 - It can cause injury to humans, problems to the product and damage the display.
- Keep out of reach of children and do not place toys near the product.
- Make sure the product ventilation hole is not blocked. Install the product more than 100 mm (3.9 inches) from the wall.
 - If you install the product too close to the wall, it may be deformed or fire can break out due to internal heat build-up.
- Do not cover the product with cloth or other material (eg. plastic) while plugged in.
 - The product can be deformed or fire can break out due to internal overheating.
- Place the product on a flat and stable surface that is large enough to support the product.
 - If the product is dropped, you may be injured or the product may be broken.
- Install the product where no Electromagnetic Interference occurs.
- Keep the product away from direct sunlight.
 - The product can be damaged.
- Do not place the product on the floor.
 - Small Children and others may trip over it.
- Do not install this product on a wall if it could be exposed to oil or oil mist.
 - This may damage the product and cause it to fall.

Precautions for Moving the Product

WARNING

- Make sure to turn off the product.
 - You may be electrocuted or the product can be damaged.
- Make sure to remove all cables before moving the product.
 - You may be electrocuted or the product can be damaged.
- Do not shock the product when moving it.
 - You may be electrocuted or the product can be damaged.
- If you drop the product, the damaged product can cause electric shock or fire.

Precautions for Using/Cleaning the Product

WARNING

- Do not attempt to disassemble, repair or modify the product yourself.
 - Fire or electric shock can occur.
 - Contact LG Customer Service for repair.
- When cleaning the product, unplug the power cord and scrub gently with a soft cloth to prevent scratching. Do not clean with a wet cloth or spray water or other liquids directly onto the product. An electric shock may occur. (Do not use chemicals such as benzene, paint thinners or alcohol.)
- Keep the product away from water.
 - Fire or electric shock accident can occur.
- Avoid high temperatures and humidity.
- Do not put or store flammable substances near the product.
 - There is a danger of explosion or fire.
- Keep the product clean at all times.
- Take a comfortable and natural position when working with the product.
- Take a regular break when working with the product for a long time.
- Keep proper distance from the product and rest from time-to-time.
 - Your vision may be impaired if you look at the product too closely or for too long.
- Set the appropriate resolution by referring to the User's Guide.
- Keep small accessories out of the reach of children.
- Do not use products using high voltage around the Signage webOS Box. (ex. Electrical Swatter)
 - Monitor may have malfunction as its electrical shock.

LICENSES

Supported licenses may differ by model. For more information of the licenses, visit www.lg.com.



The terms HDMI and HDMI High-Definition Multimedia Interface, and the HDMI Logo are trademarks or registered trademarks of HDMI Licensing Administrator, Inc. in the United States and other countries.

Manufactured under license from Dolby Laboratories. Dolby, Dolby Vision, Dolby Audio, Dolby Atmos, and the double-D symbol are trademarks of Dolby Laboratories.

For DTS patents, see <http://patents.dts.com>. Manufactured under license from DTS Licensing Limited. DTS, the Symbol, & DTS and the Symbol together, DTS 2.0 Channel, DTS 2.0+Digital Out, DTS-HD, and DTS Virtual:X are registered trademarks or trademarks of DTS, Inc. in the United States and/or other countries. © DTS, Inc. All Rights Reserved.



ASSEMBLY AND PREPARATION

CAUTION

- Do not use any pirated items to ensure the safety and product life span.
- Any damages or injuries by using pirated items are not covered by the warranty.
- Risk of explosion if battery is replaced by an incorrect type.
- Dispose of used batteries according to the instructions.

NOTE

- The accessories provided with your product may vary depending on the model or region.
- Product specifications or contents in this manual may be changed without prior notice due to upgrade of product functions.
- SuperSign Software & Manual
 - Downloading from the LG Electronics website.
 - Visit the LG Electronics website <http://partner.lge.com> and download the latest software for your model.

Optional Accessories

Without prior notice, optional accessories are subject to change to improve the performance of the product, and new accessories may be added. The illustrations in this manual may differ from the actual product and accessories.

Wi-Fi Dongle kit

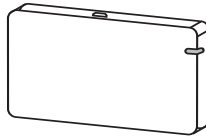

AN-WF500

CAUTION

- If you connect to a wireless LAN during wired LAN use, the network may temporarily disconnect.

NOTE

- Optional accessories are available for some models. If necessary, please purchase them separately.
- You can obtain additional accessories from your local retail store.

Parts and Buttons

The image may be different according to the model.

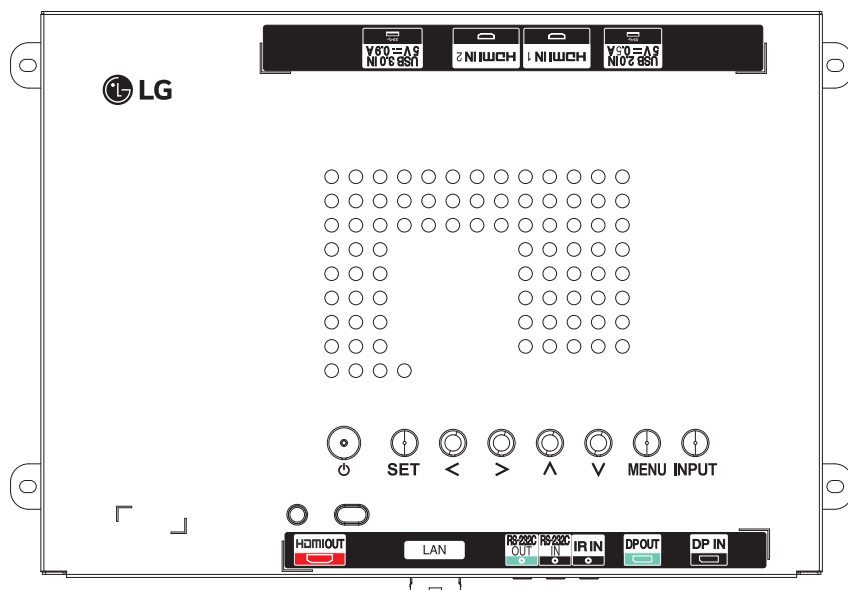

-  : Turns the power on or off.
- **SET** : Displays the current signal and mode.
- **<>** : Moves left and right.
- **^ v** : Adjusts the up and down.
- **MENU** : Accesses the main menus, or saves your input and exits the menus.
- **INPUT** : Changes the input source.

Installation

Install the set using the screws supplied as accessories.

Mounting on a wall

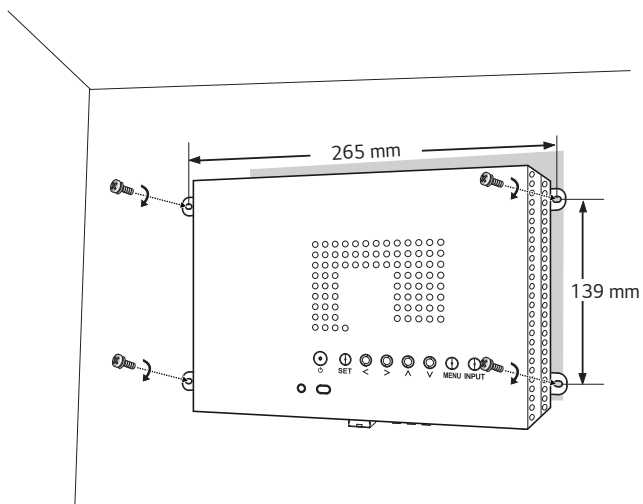

Installing on a monitor

- For some monitors only. Depending on the monitor, installation may not be possible.
 - The image may be different according to the model.
- 1 Lay a clean cloth on the floor, put the monitor on it with the screen facing downward, and then remove the screws from the hole cover on the rear of the monitor with a screwdriver.

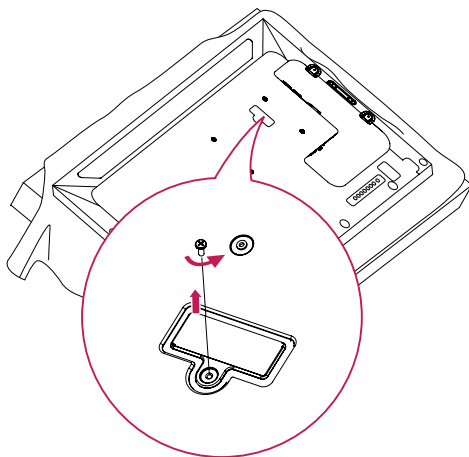

- 2 Align the WP320 along the four screw holes on the rear of the set and attach it to the rear of the set using the four screws provided.

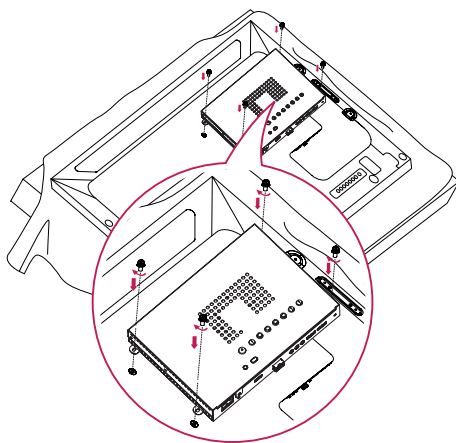

3 Installation complete

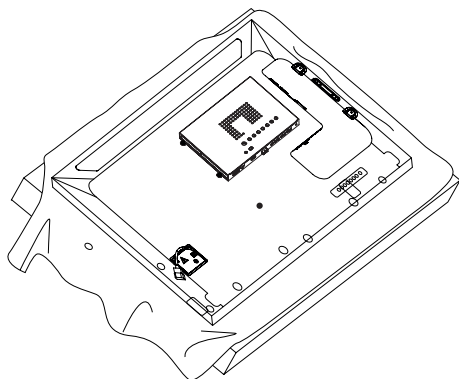

HDMI connections

Use an HDMI cable to connect to the WP320 (system controller).

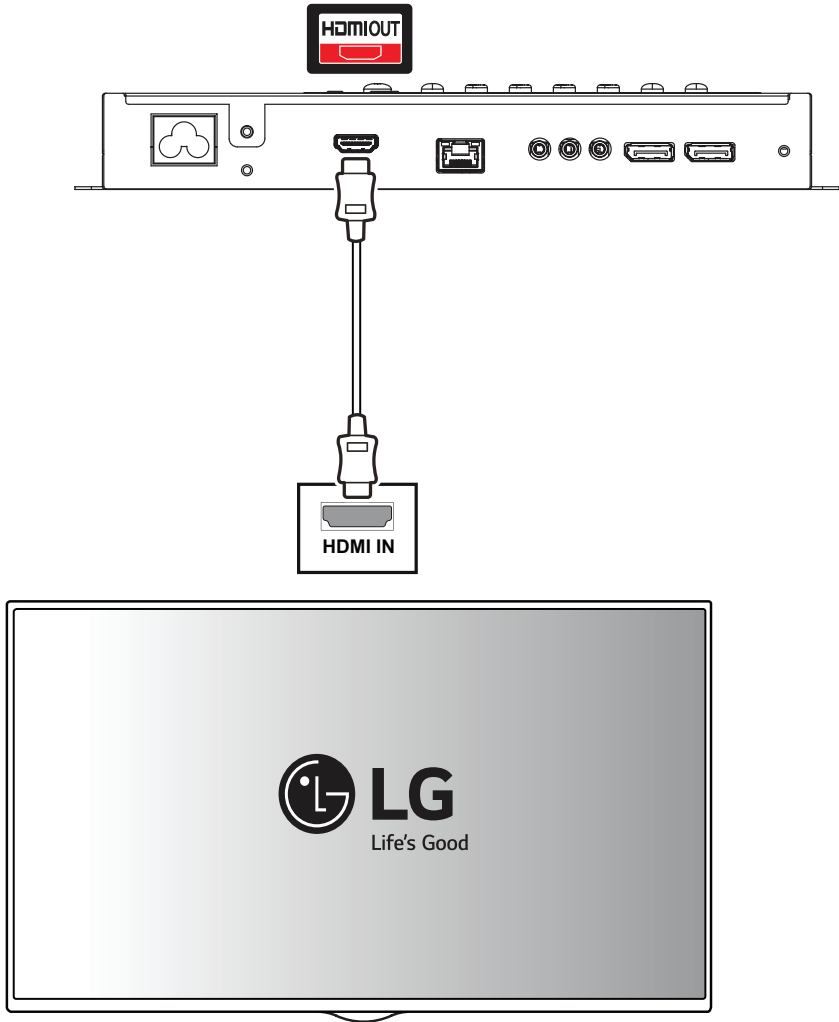

REMOTE CONTROL

The descriptions in this manual are based on the buttons on the remote control. Please read this manual carefully to use the Signage webOS Box correctly. To install batteries, open the battery cover, place batteries (1.5 V AAA) matching ⊕ and ⊖ terminals to the labels inside the compartment, and close the battery cover. To remove the batteries, perform the installation actions in reverse. The illustrations may differ from the actual accessories.

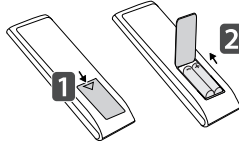

CAUTION

- Do not mix old and new batteries, as this may damage the remote control.
- Be sure to point the remote control toward the remote control sensor on the Signage webOS Box.
- Some features of the remote control may not be supported in certain models.

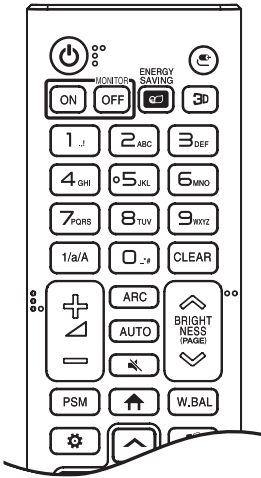

Power Turns the Signage webOS Box on or off.

MONITOR ON Turns the Signage webOS Box on.

MONITOR OFF Turns the Signage webOS Box off.

ENERGY SAVING Adjusts the brightness of the picture to reduce energy consumption.

Input Selects the input mode.

* **3D** Used for viewing 3D videos.

1/a/A Toggles between numerical and alphabetical.

Number and Alphabet buttons

Enters numerical or alphabetical characters depending upon the setting.

CLEAR Deletes the entered numerical or alphabetical character.

* **Volume Up/Down Button** Adjusts the volume.

ARC Selects the Aspect Ratio mode.

* **AUTO** Automatically adjusts picture position and minimizes image instability (available for RGB input only).

* **(Mute)** Mutes all sounds.

BRIGHTNESS Adjusts the brightness of the display. (PAGE function is not supported in this model.)

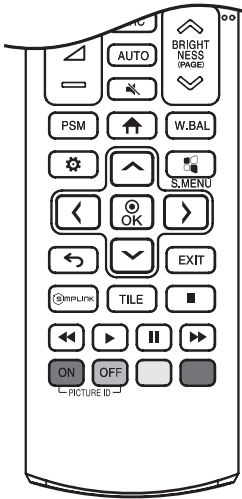

* **PSM** Selects the Picture Mode.

↑ (**Home**) Activates the Launcher.

* **W.BAL** Enters the White Balance menu.

⚙️ (**Settings**) Accesses the main menus or saves your input and exit menus.

* **S.MENU** SuperSign menu key.

Navigation Buttons Scrolls through menu or options.

⏵ Selects menus or options and confirms your input.

↶ (**Back**) Allows you to move back one step in the user interaction function.

EXIT Quit all OSD tasks and applications.

🔗 **SIMPLINK** Allows you to control various multimedia devices to enjoy multimedia simply by using the remote control through the SimplLink menu.

TILE Selects the TILE Mode.

PICTURE ID ON/OFF When the Picture ID number matches the Set ID number, you can control whichever Signage webOS Box you want in multi-display format.

USB Menu Control Buttons Controls media playback.

* **Trick key** May not be supported on some models.

* It is not supported in this model.

USING THE WP320 SET

Connecting to a PC

The WP320 does not include the monitor. You can connect WP320 to a monitor to view the picture on it. Your WP320 set supports the Plug and Play* feature.

* Plug and Play: A PC will have a built-in driver for WP320, no extra software is needed.

External Device Connection

Connect a HD receiver, DVD, or VCR player to the WP320 set and select an appropriate input mode.

Some of the cables are not provided. For the best picture quality, connecting external devices to your set using HDMI cables is recommended.

NOTE

- It is recommended to use the WP320 set with an HDMI connection for the best image quality.
- To comply with the specifications of the product, use a shielded interface cable with ferrite core, such HDMI cable provided with the product.
- To minimize the impact of electromagnetic waves, secure the cables with cable ties.
- Use a High Speed HDMI®/TM Cable.
- If you want to use HDMI-PC mode, you must set the input label to PC mode.
- When HDMI PC is used, a compatibility problem might occur.
- Use a certified cable with the HDMI logo attached. If you do not use a certified HDMI cable, the screen may not display or a connection error may occur.
- Recommended HDMI cable types
 - High Speed HDMI®/TM cable
 - High Speed HDMI®/TM cable with Ethernet

CAUTION

- If using a DP to HDMI dongle, make sure to use a dongle certified by the graphics card manufacturer.
- When connecting to multi-channel ports of a graphics card, make sure to use DP to HDMI dongles of the same model.
- It may not be compatible with monitors from other companies.

Using the Input List



- HDMI1 → HDMI2 → DISPLAYPORT

TROUBLESHOOTING

No image is displayed.

Problem	Resolution
Is the product power cord connected?	<ul style="list-style-type: none"> • Check if the power cord is correctly plugged into the power outlet.
Does the 'Invalid Format' message appear?	<ul style="list-style-type: none"> • The signal from the PC (Graphics card) is out of the vertical or horizontal frequency range of the product. Adjust the frequency range by referring to the Specifications in this manual.
Does the 'No signal' message appear?	<ul style="list-style-type: none"> • The signal cable between PC and product is not connected. Check the signal cable. • Access the input menu to check the input signal.

'Unknown Product' message appears when the product is connected.

Problem	Resolution
Did you install the driver?	<ul style="list-style-type: none"> • Check if the Plug and Play function is supported by referring to the graphics card user manual.

The screen image looks abnormal.

Problem	Resolution
Is the screen position wrong?	<ul style="list-style-type: none"> • Check if the graphics card resolution and frequency are supported by the product. If the frequency is out of range, set to the recommended resolution in the Control Panel "Display" Setting menu.
The screen is displayed abnormally.	<ul style="list-style-type: none"> • The proper input signal is not connected to the signal port. Connect the signal cable that matches with the source input signal.
The screen's image looks cut off.	<ul style="list-style-type: none"> • The monitor's screen size setting may cut off part of the image. Change the ARC of the connected device to use it.

Screen color is abnormal.

Problem	Resolution
Screen has poor color resolution (16 colors).	<ul style="list-style-type: none"> • Set the number of colors to more than 24 bits (true color). Select [Control Panel] → [Display] → [Settings] → [Color Table] in Windows. (The settings may differ depending on your operating system.)
Screen color is unstable or mono-colored.	<ul style="list-style-type: none"> • Check the connection status of the signal cable. Or, re-insert the PC graphics card.

The operation does not work normally.

Problem	Resolution
The power suddenly turned off.	<ul style="list-style-type: none"> • Is the sleep timer set? • Check the power control settings. Power interrupted.

PRODUCT SPECIFICATIONS

The product specifications below may be changed without prior notice due to upgrade of product functions.
 “~” refers to alternating current (AC), and “—” refers to direct current (DC).

Video signal	Maximum resolution	3840 x 2160 @ 30 Hz (HDMI1/ HDMI2/ DisplayPort) - This may not be supported on some OS or graphics card types.
	Recommended resolution	1920 x 1080 @ 60 Hz - This may not be supported on some OS or graphics card types.
	Horizontal frequency	HDMI1/ HDMI2/ DisplayPort : 30 kHz to 83 kHz
	Vertical frequency	HDMI1/ HDMI2/ DisplayPort : 30 Hz, 56 Hz to 60 Hz
	Synchronization	Separate Sync / Digital
Input / Output ports		LAN, USB 3.0 IN, USB 2.0 IN, RS-232C IN/OUT, DP IN/OUT, HDMI IN 1, HDMI IN 2, HDMI OUT, IR IN
Power	Rated power	AC 100-240 V ~ 50/60 Hz 0.5 A
	Power consumption	On Mode: 22 W (Max.) Off Mode: ≤ 0.5 W
Embedded battery	Applied	
Environmental Conditions	Operating Temperature	0 °C to 40 °C (32 °F to 104 °F)
	Operating Humidity	10 % to 80 %
	Storage Temperature	-20 °C to 60 °C (-4 °F to 140 °F)
	Storage Humidity	5 % to 85 %
Dimensions (Width x Height x Depth) / Weight	258 mm x 35 mm x 186.8 mm / 1.4 kg (10.1 inches x 1.3 inches x 7.3 inches / 3.0 lbs)	

HDMI/ DisplayPort (PC) Support Mode

Resolution	Horizontal frequency (kHz)	Vertical frequency (Hz)
800 x 600	37.879	60.317
1024 x 768	48.363	60
1280 x 720	44.772	59.855
1280 x 1024	63.981	60.02
1680 x 1050	65.29	59.954
1920 x 1080	67.5	60
3840 x 2160	67.5	30

HDMI/ DisplayPort (DTV) Support Mode

Resolution	Horizontal frequency (kHz)	Vertical frequency (Hz)
480/60p	31.5	60
576/50p	31.25	50
720/50p	37.5	50
720/60p	45	60
1080/50i	28.1	50
1080/60i	33.75	60
1080/50p	56.25	50
1080/60p	67.432	59.94
1080/60p	67.5	60
2160/30p	67.5	30

! NOTE

- PC resolutions available for the Input Label option in HDMI / DisplayPort input modes: 1280 x 720/60 Hz, 1920 x 1080/60 Hz; 480p, 720p, and 1080p DTV resolutions.
- Vertical frequency: The product display functions by the screen image changing dozens of times every second like a fluorescent lamp.
The vertical frequency or refresh rate is the number of image displays per second. The unit is Hz.
- Horizontal frequency: The horizontal interval is the time taken to display one horizontal line. When 1 is divided by the horizontal interval, the number of horizontal lines displayed every second can be tabulated as the horizontal frequency. The unit is kHz.



Make sure to read the Safety Precautions before using the product.

The model and serial numbers of the SET are located on the back and one side of the SET. Record it below should you ever need service.

MODEL _____

SERIAL _____

Supplier's Declaration of Conformity

Trade Name	LG
Responsible Party	LG Electronics USA, Inc.
Address	111 Sylvan Avenue, North Building, Englewood Cliffs, NJ 07632
E-mail	lg.environmental@lge.com

Temporary noise is normal when powering ON or OFF this device.



USER GUIDE

LG Digital Signage

(MONITOR SIGNAGE)

Please read this manual carefully before operation and retain it for future reference.

webOS 3.2

CONTENTS

SETTINGS4

- Home.....	4
[Global Buttons]	
[Dashboard]	
[Content Manager]	
- Ez Setting	5
[Video Wall]	
[On/Off Scheduler]	
[SI Server Setting]	
[Server Setting]	
[Fail Over]	
[Status Mailing]	
[Play via URL]	
[Setting Data Cloning]	
[Sync Mode]	
[Signage 365 Care]	
[Multi Screen]	
- General.....	11
[Language]	
[System Information]	
[Set ID]	
[Time & Date]	
[Power]	
[Network]	
[Safety Mode]	
[Expert Controls]	

- Display	25
[Picture Mode]	
[Aspect Ratio]	
[Rotation]	
[Expert Controls]	
- Sound.....	31
[Sound Mode]	
[Sound Out]	
[Audio Out]	
[Volume Increase Amount]	
[AV Sync. Adjust]	
[Digital Audio Input]	
- Admin.....	34
[Lock Mode]	
[Change PIN Code]	
[Enterprise Settings]	
[Reset to Initial Settings]	
[Factory Reset]	

CONTENT MANAGER 36

- Web Login.....36
- Content Manager36
 - [Player]
 - [Scheduler]
 - [Editor]
- Group Manager 2.043
- ScreenShare.....46

MANAGEMENT TOOLS 47

- Control Manager47
- Picture ID.....48

TOUCH 49

- Touch Assistive Menu.....49
- IDB (Interactive Digital Board).....50

IR CODE 51**CONTROLLING MULTIPLE PRODUCTS..... 53**

- Connecting cables53
- Communication Parameter54
- Command Reference List55
- Transmission/Reception Protocol59

To obtain the source code that is contained in this product, under GPL, LGPL, MPL, and other open source licenses that have the obligation to disclose source code, and to access all referred license terms, copyright notices and other relevant documents, please visit

<https://opensource.lge.com>.

LG Electronics will also provide open source code to you on CD-ROM for a charge covering the cost of performing such distribution (such as the cost of media, shipping, and handling) upon email request to opensource@lge.com.

This offer is valid to anyone in receipt of this information for a period of three years after our last shipment of this product.



NOTE

- Software-related content may be changed without prior notice due to upgrades of the product functions.
- Some features described in the User Manual may not be supported in certain models and countries.
- SNMP 2.0 is supported.

SETTINGS

Home

[Global Buttons]

-  [MOBILE URL]: Provides information necessary to access the monitor set through an external device's browser. With this feature, you can view QR code and URL information. In addition, by accessing the URL, you can also run Content Manager and Group Manager 2.0, and Control Manager. (This featured is optimized for Google Chrome.)
-  [Input]: Navigate to the external input selection screen
-  [Settings]: Navigate to the Settings screen

[Dashboard]

- This feature displays key information about your Signage monitor in the center of the home screen. In the Dashboard, you can manually change settings by selecting the corresponding items.

NOTE

- If the dashboard is locked, the focus does not move.

[Content Manager]

- [Player]: Play a variety of content including images, videos, and SuperSign content.
- [Scheduler]: Manage schedules for content that will be played at different times.
- [Editor]: You can create your own content using templates and media files.
- [Group Manager 2.0]: Distribute content schedules and setting data to the connected device.

Ez Setting

[Video Wall]

SETTINGS / ⚙️ → [Ez Setting] → [Video Wall]

Set Video Wall options to create a wide visual canvas.

- [Tile Mode]: Turn [Tile Mode] on or off.
- [Tile Mode Setting]: Display a single integrated screen on multiple Signage monitors.
- [Natural Mode]: Display the image excluding the area that overlaps with the monitor's bezel so that the image displayed has a more natural feel to it.
- [Frame Control]: Adjust the sets that run [Scan Inversion] and frame deviation.
 - When running [Scan Inversion], please run [Frame Control] for the sets that do not run [Scan Inversion].
- [Scan Inversion]: Reduce screen deviation between adjoining video walls by changing screen scanning method.
- [White Balance]: Configure white balance settings (White Pattern, R/G/B-Gain, and Luminance).
- [RESET]: Reset to initial settings.

! NOTE

- When Tile Mode is enabled, automatically set [Frame Control] for odd numbered rows and [Scan Inversion] for even numbered rows.

[On/Off Scheduler]

SETTINGS / ⚙️ → [Ez Setting] → [On/Off Scheduler]

Set a schedule to use your signage by time and day of the week.

- [On/Off Time Setting]: Set on/off times for each day of the week.
- [Holiday Setting]: Set holidays by date and by day of the week.

[SI Server Setting]

SETTINGS / ⚙️ → [Ez Setting] → [SI Server Setting]

Set up to connect your signage to an external SI server. Set up a server environment for SI app installation.

SETTINGS / ⚙️ → [Ez Setting] → [SI Server Setting] → [Developer Mode & Beanviser]

This feature provides great convenience to the app developers.

Set up to install and activate the Developer mode and BEANVISER app.

! NOTE

- To use these features, an account (ID/Password) for webOS Signage developer website (<http://webossignage.developer.lge.com/>) is required.

[Server Setting]

SETTINGS / ⚙️ → [Ez Setting] → [Server Setting]

Set up to connect your signage to a SuperSign server.

- CMS servers
- Control servers

[Fail Over]

SETTINGS / ⚙️ → [Ez Setting] → [Fail Over]

This feature enables automatically switching to other input sources in order of priority if the primary signal is interrupted. It also enables the automatic playback of the content stored on your device.

- [On/Off]: Turns [Fail Over] on or off.
- [Input Priority]: Set the priority of input sources for fail over.
- [Backup via Storage]: Automatically play the content stored on the device when there is no input signal. Set to [On] to activate Auto, Manual, and [SuperSign Contents].
 - Auto: When the automatic input switches due to taking screenshots of an image or video that is playing at regular intervals, this feature will play back the file. (OLED model is not supported.)
 - > [Capture time Interval]: The time interval can be set to 30 min, 1 hour, 2 hours and 3 hours.
 - Manual: When the automatic input switches due to the image and video file being uploaded, the feature will play back the file.
 - > [Backup media select]: Using the settings button, you can upload a single file in the internal / external memory.
 - > [Preview]: You can preview the uploaded file.
 - [SuperSign Contents]: When the automatic input switches, this feature will play the file(s) distributed in SuperSign CMS.
- [RESET]: Reset to initial settings.

[Status Mailing]

SETTINGS / ⚙️ → [Ez Setting] → [Status Mailing]

This feature configures the system so that the status of the device is assessed and then notified to the administrator by e-mail.

- [On/Off]: Turns [Status Mailing] on or off.
- [Mailing Option], [SCHEDULE]: Sets the email sending interval.
- [User E-mail Address]: Set the user email address of the sender.
- [Sending Server(SMTP)]: Set the address of the SMTP server.
- [ID]: Enter the account ID of the sender.
- [Password]: Enter the password for the sender's account.
- Recipient E-mail Address: Set the email address of the recipient.
- Message Delivery: Immediately assess the status of the device and deliver the information to the specified email address.
- [RESET]: Reset to initial settings.

! NOTE

- If the status regarding any of the following items changes or becomes abnormal, a status message can be sent.
 - 1. Temp. Sensor: If the set reaches a dangerous temperature, its current temperature is recorded, and an email containing such information is sent.
 - 2. Temp. Sensor Validation: An email is sent if there is no temperature sensor connected, if the communication status of the temperature sensor is unknown, or if the information provided by the chip provider is abnormal.
 - 3. LAN Status, Wi-Fi Status: An email is sent if there is a change in the network's connection status. The maximum number of network status changes that can be saved is limited to 50. The saved value is reset once the power turns off.
 - 4. Screen Fault Detection: An email is sent if an abnormal value is picked up by the RGB sensor while Screen Fault Detection is turned on in the Settings.
 - 5. No Signal Check: Checks whether there is a signal. If there are no signals for more than 10 seconds, an email is sent.
 - 6. Schedule Play Status: An email is sent if content cannot be played between the scheduled start time and end time in either Content Management Schedule status or SuperSign Content status. However, this does not apply when terminated using the remote control.
 - 7. Fail Over Status: An email is sent if input switching occurred due to an error. (Excludes input switching initiated by the user (RC, RS232C, SuperSign))
- Only SMTP ports 25, 465, and 587 are supported.
- The occurrence of internal input switches, excluding external input switches (RC, RS232C, SuperSign), are considered as Fail Over Status.
- One email containing the "Failover status : Failover" message is sent when switching to Fail Over Status, and the following status emails sent regularly or upon status changes contain the message "Failover status : None".

[Play via URL]

SETTINGS / ⚙️ → [Ez Setting] → [Play via URL]

Play content you want to play automatically through the built-in web browser.

- [URL Loader]: Turns [Play via URL] on or off.
- [Set URL]: Enter the URL address to display automatically.
- [Preview]: Preview your desired website by accessing the specified URL.
- [SAVE]: Save the specified URL.
- [Reboot to Apply]: Restarts the monitor set after saving the specified URL.
- [RESET]: Reset to initial settings.

! NOTE

- This feature does not apply when [Screen Rotation] is enabled, and using this feature disables [Preview].
- [Time & Date] is not set to [Set Automatically], website navigation may be difficult.
 - **SETTINGS / ⚙️** → [General] → [Time & Date] → Check [Set Automatically]

[Setting Data Cloning]

SETTINGS / ⚙️ → [Ez Setting] → [Setting Data Cloning]

This feature is used to copy and import the settings of the device to other devices.

- [Export Setting Data]: Export the settings of the device to another device.
- [Import Setting Data]: Import the settings of another device into the device.

[Sync Mode]

SETTINGS / ⚙️ → [Ez Setting] → [Sync Mode]

Sync up time and content among multiple signages.

- [RS-232C Sync]: Sync up multiple signages connected by RS-232C.
- [Network Sync]: Sync up multiple signages connected to the same network.

[Signage 365 Care]

SETTINGS / ⚙️ → [Ez Setting] → [Signage 365 Care]

You can install the Signage 365 Care (fault diagnosis) solution for fault diagnosis and prediction service.

- [Install]: Installs the Signage 365 Care solution.
 - 1) [ENTER ACCOUNT NUMBER]: Enters the 6-digit account number to install the Signage 365 Care solution.
 - Account Number: The number assigned when the Signage 365 Care solution is registered. When the account number is entered, the account name corresponding to the number is obtained.
 - 2) [CONFIRM ACCOUNT NUMBER]: Displays the account number and the account name corresponding to the account number and validates the account number.
 - If the account number is registered, the account name corresponding to the account number is displayed, and you can continue to install the Signage 365 Care solution.
 - If the account number is not registered, "Unknown" is displayed as the account name, and you cannot continue to install the solution.
- [Enable]/[Disable]: Sets whether to Enable/Disable the Signage 365 Care solution.
- [Account]: Displays user's currently connected account number and name.
- [Version]: Displays the version of the Signage 365 Care solution.
- [Check for Update]: Checks for available updates in the server.
- [Update]: Updates the Signage 365 Care solution to the latest version.
- [Server Status]: Displays the status of connection between the set and server.
 - [Connected]: Displayed when the set and server are connected.
 - [Not Connected]: Displayed when the set and server are disconnected.
 - [Waiting for Approval]: Displayed when the server is waiting for approval.
 - [Rejected]: Displayed when the server rejected the connection.
- [Reset]: Deletes the installed Signage 365 Care solution.

[Multi Screen]

SETTINGS / ⚙️ → [Ez Setting] → [Multi Screen]

This feature allows you to view multiple external inputs and videos on a single screen.

! NOTE

- After entering multi-screen mode, the screen may flicker and the picture may appear abnormal on certain devices while the optimal resolution is selected automatically. If this happens, please restart the monitor.
- In multi-screen mode, the DP daisy chain feature is not supported.

[Selecting Screen Layout]

When you enter multi-screen mode without having set any screen layout, the screen layout selection menu appears. When the screen layout selection menu is not displayed on the screen, go to the screen layout menu bar by pressing the up arrow key on your remote control and select your desired screen layout. If you want to close the screen layout menu, press the back key.

[Closing Screen Layout Menu]

From the screen layout menu, press the up arrow key on the remote control to go to the screen layout menu bar and select it or press the back key to close the screen layout menu.

[Changing Screen Input]

Press the  button on the top right of each split screen to select the desired input.

! NOTE

- Inputs which have already been selected for other split screens cannot be selected again. To select them, press the RESET button to reset the inputs for all screens first.
- PIP mode works only when External Input Rotation is set to Off and Screen Rotation is set to Off.

[Playing Videos on Split Screens]

Press the  button on the upper right of each split screen, select Video File, and then select a storage device to view the list of videos in the selected device. Next, select your desired video from the list to play it.

! NOTE

- Videos created with HEVC, MPEG-2, H.264, or VP9 codecs can be played on split screens. When using PIP mode, the following combinations cannot be used.

Main	Sub
HEVC	HEVC
H.264	HEVC
MPEG-2	HEVC
VP9	VP9

General

[Language]

SETTINGS / ⚙️ → [General] → [Language]

You can select the menu language to be displayed on the screen.

- [Menu Language]: Sets the language of your Signage monitor.
- [Keyboard Language]: Sets the language of the keyboard displayed on the screen.

[System Information]

SETTINGS / ⚙️ → [General] → [System Information]

This feature displays information such as the device name, software version, and storage space.

[Set ID]

SETTINGS / ⚙️ → [General] → [Set ID]

- [Set ID] (1-1000): Assigns a unique Set ID number to each product when several products are connected via RS-232C. Assign numbers ranging from 1 to 1000 and exit the option. You can control each product separately by using the Set ID you assigned to each product.
- [Auto Set ID]: Automatically assigns a unique Set ID number to each product when several products are connected for display.
- [Reset ID]: Reset the Set ID of the product to 1.

[Time & Date]

SETTINGS / ⚙️ → [General] → [Time & Date]

This feature enables you to view and change the time and date on the device.

- [Set Automatically]: Set [Time] and [Date].
- [Daylight Saving Time]: Set the start and end times for Daylight Saving Time. The DST start/end times function only when you set them more than one day apart from each other.
- [NTP Server Setting]: Allows you to set other NTP servers other than the basic NTP server.
- [Time Zone]: Configure the continent, country/region and city.

[Power]

SETTINGS / ⚙️ → [General] → [Power]

Power-related feature settings

[No Signal Power Off (15 Min)]

Set whether to use the 15 Min Auto Off feature.

- You can set this option to [On] or [Off].
- If you set this feature to [On], the product turns off when it has remained in No Signal status for 15 minutes.
- If you set this feature to [Off], the 15 Min Force Off feature is disabled.
- It is recommended that you set this feature to [Off] if you intend to use the product for long periods of time as the feature turns the power of the product off.

[No IR Power Off (4hour)]

Set whether to use 4 Hours Off feature.

- You can set this option to [On] or [Off].
- If you set this feature to [On] the product turns off if there is no input from the remote control for 4 hours.
- If you set this feature to [Off], the 4 Hours Off feature is disabled.
- It is recommended that you set this feature to [Off] if you intend to use the product for long periods of time as the feature turns the power of the product off.

[DPM (Standby Mode)]

Set the Display Power Management (DPM) mode.

- If this feature is not set to [Off], the monitor will enter DPM mode when there is no input signal.
- If you set this feature to [Off], [DPM (Standby Mode)] is disabled.

[DPM (Standby Mode) Wake Up control]

Turns on the set according to the digital signal processing of the connected DVI-D/HDMI port.

- [Clock], the set only checks for digital clock signals and turns on once it finds the clock signal.
- [Clock+DATA], the set turns on if the digital clock and data signals are both input.

[PM Mode]

- [Power Off(Default)]: Sets the normal DC off mode.
- [Sustain Aspect Ratio]: Identical to normal DC off mode except that the Switching IC remains on. On some models, this applies only to a specific input mode (DisplayPort) and has the same effect as [Screen Off Always] in other input modes.
- [Screen Off]: Switches to [Screen Off] status when entering DPM, Auto Power Off (15 mins, 4 hours), or Abnormal Shut Down mode.
- [Screen Off Always]: Switches to [Screen Off] status when entering DPM, Auto Power Off (15 mins, 4 hours), Off Time Scheduling, or Abnormal Shut Down mode, or when there is input from the remote control's Power button or the monitor's Off button.
- [Screen Off & Backlight On]: Partially turns on the backlight to keep the display at a proper temperature when in Screen Off status.

! NOTE

- In order for the screen to switch from [Screen Off] to On status, there must be input from the remote control's Power or Input button, or the monitor's On button.

[Power On Delay (0-250)]

- This feature prevents overload by implementing a power-on delay when multiple monitor sets turn on.
- You can set the delay interval in the range of 0 to 250 seconds.

[Power On Status]

- Select the operating status of the monitor when the main power has turned on.
- You can choose from among [PWR (Power On)], [STD (Standby)], and [LST (Last Status)].
- [PWR (Power On)] keep the monitor powered on when the main power has turned on.
- [STD (Standby)] switch the monitor to Standby status when the main power has turned on.
- [LST (Last Status)] switches the monitor back to its previous status.

[Wake On LAN (Networked standby mode)]

- Set whether to use [Wake On LAN (Networked standby mode)].
- You can set the feature to On or Off for each wired/wireless network.
- [Wired]: When set to [On], the [Wake On LAN (Networked standby mode)] feature is enabled, letting you turn the product on remotely through a wired network.
- [WiFi]: When set to [On], the [Wake On LAN (Networked standby mode)] feature is enabled, letting you turn the product on remotely through a wireless network.

[Power Indicator]

- This function enables you to change the [Power Indicator] settings.
- Setting to [On] will turn on [Power Indicator].
- Setting to [Off] will turn off [Power Indicator].
- Regardless of [On] or [Off] settings in [Power Indicator], [Power Indicator] will be turned on for approximately 15 seconds.

[Power On/Off History]

Display the device's power on/off history.

[Network]

SETTINGS / ⚙️ → [General] → [Network]

[Wired Connection (Ethernet)]

- [Wired Connection]: Connects the monitor to a local area network (LAN) via the LAN port and configures wired network settings. Only wired network connections are supported. After setting up a physical connection, the display will automatically connect without any adjustments on most networks. A small number of networks may require the display settings to be adjusted. For detailed information, contact your Internet provider or consult your router manual.

[Wi-Fi Connection]

If you have set your monitor up for a wireless network, you can view and connect to available wireless Internet networks.

- [Add a Hidden Wireless Network]: You can add a wireless network by manually typing in its name.
- [Connect via WPS PBC]: Press the button on the wireless router that supports PBC to easily connect to the router.
- [Connect via WPS PIN]: Enter the PIN number in the web page of the PIN-supporting wireless router to connect to the router in a simple manner.
- [Advanced Wi-Fi Settings]: When there is no available wireless network displayed on the screen, you can connect to the wireless network by entering the network information directly.

! NOTE

- On models that support Wi-Fi dongles, the Wireless Network Connection menu is enabled only when a Wi-Fi dongle is connected.
- When connected to a network that supports IPv6, you can select IPv4 / IPv6 in the wired / wireless network connection. But, IPv6 connection only supports automatic connection.

[LAN Daisy Chain]

- LAN Daisy Chain forms a daisy chain of LAN ports so that even if you connect only one monitor set to a network, the other sets in the daisy chain are connected to the network.
- However, the first monitor set in the daisy chain must be connected to the network through a port that is not used for the daisy chain connection.

[SoftAP]

If you set up a SoftAP, you can connect many devices via a Wi-Fi connection without a wireless router and use wireless Internet.

- You must have an Internet connection.
- The SoftAP and ScreenShare features cannot be used at the same time.
- On models that support Wi-Fi dongles, the SoftAP menu is enabled only when a Wi-Fi dongle is connected to the product.
- SoftAp Access Information
 - SSID: A unique identifier necessary to make a wireless Internet connection
 - Security key: The security key you enter to connect to the desired wireless network
 - Number of connected devices: Shows the number of devices currently connected to your Signage device via a Wi-Fi connection. Up to 10 devices are supported.

[UPnP]

Open and block UDP port 1900, which is used for UPnP.

- The default setting is [On]. Setting this feature to [Off] blocks UDP port 1900, making the UPnP function unavailable.
- If you set this feature to [Off], Sync Mode's "Network" option will be deactivated. When the value for Sync Mode is "Network," the value switches to [Off], deactivating the "Network" option.
- If you change the UPnP value, the change will not be applied before a reboot.
- If you set UPnP to [Off], you cannot use Group Manager 2.0 properly.

[Ping Test]

Check your network connection status via Ping Test.

[Port Control]

Unused ports can be blocked for network security.

[Connection Domain]

Change domain for checking network connection.

! NOTE

- A reboot is recommended for the settings to be applied properly.

Tips for Network Settings

- Use a standard LAN cable (Cat5 or higher with a RJ45 connector) with this display.
- Many network connection problems during set up can often be fixed by re-setting the router or modem. After connecting the display to the home network, quickly power off and/or disconnect the power cable of the home network router or cable modem, Then power on and/or connect the power cable again.
- Depending on the Internet service provider (ISP), the number of devices that can receive INTERNET service may be limited by the applicable terms of service. For details, contact your ISP.
- LG is not responsible for any malfunction of the display or Internet connection failures due to communication errors/ malfunctions associated with your Internet connection or other connected equipment.
- LG is not responsible for problems within your INTERNET connection.
- You may experience undesired results if the network connection speed does not meet the requirements of the content being accessed.
- Some INTERNET connection operations may not be possible due to certain restrictions set by the Internet service provider (ISP) supplying your Internet connection.
- Any fees charged by an ISP including, without limitation, connection charges are your responsibility.

! NOTE

- If you want to access the Internet directly on your display, the INTERNET connection should always be on.
- If you cannot access the Internet, check the network conditions from a PC on your network.
- When you use Network Setting, check the LAN cable or check if DHCP in the router is turned on.
- If you do not complete the network settings, the network may not function correctly.

! CAUTION

- Do not connect a modular phone cable to the LAN port.
- Since there are various connection methods, please follow the specifications of your telecommunication carrier or INTERNET service provider.
- Network setting menu will not be available until the display connected to physical network.

Tips for When Configuring Wireless Network Settings

- The wireless network may be affected by interference from a device that uses 2.4 GHz frequency, such as a wireless telephone, Bluetooth device or microwave. Interference may also be caused by a device that uses 5 GHz frequency such as Wi-Fi devices.
- The wireless network service may run slowly depending on the surrounding wireless environment.
- Some devices may have a network traffic jam if any local home networks are turned on.
- To connect to a wireless router, a router that supports wireless connection is necessary; the wireless connection function of the corresponding router must also be activated. Ask the router manufacturer whether the router supports wireless connection.
- To connect to a wireless router, verify the SSID and security settings of the wireless router. Please refer to the user guide of the corresponding router regarding SSID and security settings of the wireless router.
- The monitor may not work properly if network devices (wire/wireless router or hub, etc.) are incorrectly set up. Be sure to install the devices correctly by referring to their user guides before configuring the network connection.
- The connection method may vary according to the manufacturer of the wireless router.

[Safety Mode]

SETTINGS / ⚙️ → [General] → [Safety Mode]

Set to this function for safe performance.

[ISM Method]

If a still image is displayed on the screen for an extended period of time, image sticking can occur. The ISM method is a feature that prevents image sticking.

[Mode]

- Selects the desired [ISM Method] mode.
- [Normal]: Disables the ISM method.
- [Inversion]: Inverts screen colors to remove image sticking. (This option is disabled when the current input source is No Signal.)
- [Orbiter]: Moves the screen display by 4 pixels in a certain order to prevent image sticking. (This option is disabled when the input source is No Signal.) (OLED model is not supported.)
- [White Wash]: Displays a white pattern to remove image sticking.
- [Color Wash]: Alternately displays a white pattern and a color pattern to remove image sticking.
- [Washing Bar]: Displays a bar on the screen to make the image move smoothly. You can download your desired image and display it on the bar.
- [User Image]: Displays your desired images using USB. (OLED model is not supported.)
- [User Video]: Plays your desired video.

[Repeat]

- [Off, just 1 time]: If you select the desired mode and press DONE, ISM operates immediately.
- [On]: If the screen remains still for a specified wait time, ISM operates for the specified duration time.
- [On, with moving detection]: Only applies to Orbiter mode. If the screen remains still for the specified Wait time, ISM operates for the specified Duration time.
- [On, without moving detection]: Only applies to Orbiter mode. ISM immediately starts operating and continues to operate as soon as the DONE button is clicked.
- [Schedule]: Enables ISM feature in accordance with the set date, start time, and end time.

[Wait]

- You can set the time between 1–24 hours.
- This option is available only when you have set [Repeat] to [On].
- The ISM feature starts when the image freezes for a specified period of time.

[Duration]

- You can select from among 1–10 mins/20 mins/30 mins/60 mins/90 mins/120 mins/180 mins/240 mins.
- This option is available only when you have set [Repeat] to [On].
- ISM operates for the specified time.

[Select Day]

- You can set the date.
- This option is available only when [Repeat] is set to [Schedule].

[Start Time]

- Set the Start time.
- This option is available only when [Repeat] is set to [Schedule].
- You cannot set the same time for Start time and End time.

[End Time]

- Set the End time.
- This option is available only when [Repeat] is set to [Schedule].
- You cannot set the same time for Start time and End time.

[Action Cycle]

- You can select from among 1–10 mins/20 mins/30 mins/60 mins/90 mins/120 mins/180 mins/240 mins.
- This option is available only when you have selected [Inversion] or [Orbiter].
- [Orbiter]: Moves the position of the screen at specified intervals.
- [Inversion]: Inverts the screen color at specified intervals.

[Bar Image]

- [Off]: Displays a bar with a fixed resolution of 300 x 1080, then moves the bar.
- [On]: Displays and moves an image downloaded by the user. The image is displayed with a fixed height of 1080 and the same width as downloaded. However, if the width of the image is below 300, it will have a fixed value of 300.
- This option is available only when you have selected [Washing Bar].
- If you have downloaded only one image, the bar is moved and the image is displayed alone.
- If you have downloaded multiple images, up to four images are displayed in sequence per cycle.

[Bar Color]

- You can choose from six colors: red, green, blue, white, black, and gray.
- This feature is only applicable when [Bar Image] is set to [Off].
- This option is available only when you have selected [Washing Bar].

[Transparency]

- [Off]: Displays the bar opaquely.
- [On]: Displays the bar translucently. (Transparency: 50 %)
- This option is available only when you have selected [Washing Bar].

[Direction]

- [Left To Right]: The bar is moved from left to right.
- [Right To Left]: The bar is moved from right to left.
- This option is available only when you have selected [Washing Bar].

[Bar Image Download]

- To download an image, the image file must be located under the folder titled "ISM" on your USB drive.
- Make sure to delete the old images stored in the internal memory before downloading a new image file.
- Supported image file types: "BMP", "JPG", "JPEG", "PNG"
- You can download up to four images. (Resolution: 1920 x 1080 or lower)
- If there are no images, or if the existing images have been deleted, the default image is used. (The default image is an image of a white bar.)
- This option is available only when [Bar Image] is [On].

[User Image Download]

- To download an image, the image file must be located under the folder titled "ISM" on your USB drive.
- Make sure to delete the old images stored in the internal memory before downloading a new image file.
- Supported image file types: "BMP", "JPG", "JPEG", "PNG"
- You can download up to four images. (Resolution: 1920 x 1080 or lower)
- If there are no images, or if the existing images have been deleted, the default image is used. (The default image is a white background image.)
- This option is available only when you have selected [User Image].

[User Video Download]

- To download a video, the video file must be located under the folder titled "ISM" on your USB drive.
- Make sure to delete the old contents stored in the internal memory before downloading a new video file.
- Supported video file types: "MP4", "AVI", "FLV", "MKV", "MPEG", "TS"
- You can download up to one video.
- If there are no videos, or if the existing videos have been deleted, the default video is used. (The default video is a white background image.)
- This option is available only when you have selected [User Video].

*** How to reset or delete downloaded Bar image / User image / User video**

- Reset using [SETTINGS] > [Admin] > [Factory Reset]
- Open the Player app > Click "Delete" button at the top right of the screen > Delete downloaded image / video

[Screen Fault Detection]

- The screen fault detection feature determines whether there is an abnormality at the end of screen; R, G, and B OSDs are created in the upper left-hand corner of the panel at intervals of about one second, and then a pixel sensor checks the area.
- Setting this feature to [On] enables the screen fault detection feature.
- Setting this feature to [Off] disables the screen fault detection feature.

[Expert Controls]

SETTINGS /  → [General] → [Advanced Setting]

[Beacon]

- This option enables BLE Beacon, one of Bluetooth 4.0's features.
- Beacon Mode (On/Off Toggle): enables the Beacon feature.
- The LG Beacon/iBeacon/Eddystone Type Beacon features are supported.
- LG Beacon/iBeacon
 - Beacon UUID (hex): Set the UUID.
 1. Field1: 4byte hex value (8 digits)
 2. Field2: 2byte hex value (4 digits)
 3. Field3: 2byte hex value (4 digits)
 4. Field4: 2byte hex value (4 digits)
 5. Field5: 6byte hex value (12 digits)
 - Major (0-65535): Sets the Major value.
 - Minor (0-65535): Sets the Minor value.
- Eddystone
 - Frame: Set UUID or URL.
 1. Beacon UUID (hex): Set the UUID.
 - (1) Field1: 10byte hex value (20 digits)
 - (2) Field2: 6byte hex value (12 digits)
 2. Setting the URL method
 - URL Prefix: Sets the prefix of the URL.
 - URL Suffix: Set the suffix of the URL.
 - URL: Enter the part of the URL that excludes the prefix and suffix.
 - URL string length is limited to 17 characters.
- [OK]: The button used to confirm and apply the settings that you have entered.

! NOTE

- Some models do not support background screening services in iOS.
- A reboot is recommended for the settings to be applied properly.
- The UUID value is hexadecimal and the exact number of digits must be entered.

[OPS Control]

- [OPS Power Control]: This feature enables you to control the power of the OPS as you turn on/off the display.
 - [Disable]: Disable [OPS Power Control].
 - [Sync (On)]: Synchronize the monitor's power status only when the monitor is on.
 - [Sync (On/Off)]: Synchronize the monitor's power status with the OPS.
- [Control Interface Selection]: This feature enables you to configure communication with the OPS connected to your monitor.
 - [Display]: Enable communication with external serial ports.
 - [OPS]: Enable communication with the OPS connected to your monitor.

[Background Image]

This feature enables you to set the default background image.

- [Booting Logo Image]: Change the logo image that appears when the device boots up. If you set this option to Off, no logo image appears when the device boots up. Download or initialize an image file on the storage device.
- [No Signal Image]: Changes the image that appears when there is no signal. If you set this option to Off, no image appears when there is no signal. Download or initialize an image file on the storage device.

[Input Manager]

You can set the PC or DTV label for each external input.

[SIMPLINK Setup]

- When the [SIMPLINK Setup] is set to [On], you can use the SIMPLINK provided by LG Signage.
- [Device ID]: Set the ID of the device connected via CEC wiring. You can choose a value between [All] and [E].
- [StandBy]: Sets the scenarios for sending and receiving the OpStandBy (0x0c) command. Detailed scenarios are as follows:

	Transmission	Reception
All	O	O
Send Only	O	X
Receive Only	X	O

[Crestron]

- This function enables synchronization with applications provided by Crestron.
- Server: This menu sets the server's IP address for the network connection with the server (equipment provided by Crestron).
- Port (1024-65535): This menu sets the port for the network connection with the server. The default port number is 41794.
- IP ID (3-254): This menu sets a unique ID for synchronizing with the application.

Display

[Picture Mode]

SETTINGS / ⚙️ → [Display] → [Picture Mode]

[Mode]

This feature enables you to choose the optimal picture mode for your installation environment.

- [Mall/QSR], [Transportation], [Education], [Gov./Corp.], [Game], and [Photo]: Display the picture optimally for your installation environment.
- [Normal]: Display the picture at normal contrast, brightness, and sharpness.
- [Auto Power Save]: Adjust the screen brightness to reduce power consumption.
- [Expert], [Calibration]: Allow an expert, or anyone who loves picture quality, to manually tune to the best picture quality.

! NOTE

- The kinds of [Picture Mode] you can select may vary depending on the input signal.
- [Expert] is an option that allows a picture quality expert to fine-tune the picture quality using a specific image. Thus, it may not be effective for a normal picture.

[Customize]

- [Backlight]: Adjust the brightness of the screen by adjusting the brightness of the backlight. The closer the value is to 100, the brighter the screen is.
- [OLED Light]: Adjusts the screen brightness by varying the brightness of the OLED panel.
- [Contrast]: Adjust the difference between the light and dark areas of the picture. The closer the value is to 100, the greater the difference is.
- [Brightness]: Adjust the overall brightness of the screen. The closer the value is to 100, the brighter the screen is.
- [Sharpness]: Adjust the sharpness of the edges of objects. The closer the value is to 50, the clearer and the sharper the edge becomes.
- [H Sharpness]: Adjust the sharpness of the contrast edges on the screen from a horizontal point of view.
- [V Sharpness]: Adjust the sharpness of the contrast edges on the screen from a vertical point of view.
- [Color]: Soften or deepen the tints on the screen. The closer the value is to 100, the deeper the colors become.
- [Tint]: Adjust the balance between red and green levels displayed on the screen. The closer to Red 50, the redder the color will be. The closer to Green 50, the greener the color will be.
- [Color Temperature]: The higher you set the color temperature, the cooler the colors on the screen will feel. The lower you set the color temperature, the warmer the colors on the screen will feel.
- [Expert Controls] Customize the advanced options.
 - [Dynamic Contrast]: Optimize the difference between the light and dark parts of the screen according to the brightness of the image.
 - [Super Resolution]: Sharpen the areas of the screen that are blurry or barely distinguishable.
 - [Color Gamut]: Select the range of colors available.
 - [Dynamic Color]: Adjust the tint and saturation of the image for a more vivid and lively display.
 - [Edge Enhancer]: Provide much sharper and clearer edges to the picture.
 - [Color Filter]: Accurately adjust color and tint by filtering a specific color area of RGB space.
 - [Preferred Color]: Adjust the skin tint, grass tint, and sky tint to your preference.
 - [Gamma]: Adjust gamma settings to compensate for the brightness of the input signal.
 - [White Balance]: Adjust the overall color fidelity of the screen to your liking. In Expert mode, you can fine-tune the picture using the Method/Pattern options.
 - [White Balance Setting Mode]: You can select the white balance setting mode.
 - [Color Management System]: Experts use the color management system when they adjust the colors by using the test pattern. The color management system allows you to make an adjustment by selecting from among 6 different color spaces (Red/Yellow/Blue/Cyan/Magenta/Green) without affecting other colors. In a normal picture, you may not notice the color changes you have made.

- [Picture Option]: Customize the picture options.
 - [Noise Reduction]: Remove randomly popping dots to make the picture look clearer.
 - [MPEG Noise Reduction]: Reduce the noise generated in the process of creating a digital video signal.
 - [Black Level]: Adjust the brightness and contrast of the screen by adjusting the black level of the screen.
 - [Real Cinema]: Optimize the video image for a cinematic look.
 - [Motion Eye Care]: Reduce eye fatigue by adjusting brightness levels and lessening blurriness based on the displayed image.
 - [LED Local Dimming]: Make the light areas of the screen lighter and the dark areas darker for maximum contrast.
Setting this feature to Off may increase the monitor's power consumption.
 - [TruMotion]: Reduce image shaking and image sticking that can occur with moving images. (Some models do not support playback of the content.)
- [Apply to all inputs]: Save the current customized setting values to currently selected picture mode for all inputs.
- [Reset]: Reset the picture settings. Because the picture settings are reset according to the monitor's picture mode, please select the picture mode before resetting the picture settings.

[Aspect Ratio]

SETTINGS / ⚙️ → [Display] → [Aspect Ratio]

This feature enables you to change the picture size to view the picture at its optimal resolution.

- [Full Wide]: Stretch the picture to fill the screen.
- [Original]: Display the picture at its original resolution.

[Rotation]

SETTINGS / ⚙️ → [Display] → [Rotation]

[Screen Rotation]

- This feature rotates the screen clockwise.
- You can set this feature to Off/90/180/270.
- When set to off, this feature is deactivated.
- It is recommended that you use content designed to be used in Portrait mode.

[External Input Rotation]

- This feature rotates the screen clockwise.
- You can set this feature to Off/90/180/270.
- When this feature is set to On (90 or 270 degrees), as for ARC, the picture is resized to be [Full Wide].
- If [External Input Rotation] is enabled during WiDi operation, the position of the mouse cursor may not be displayed accurately.
- Please note that the degradation of picture quality that occurs when you have enabled [External Input Rotation] during the use of external input has nothing to do with the product itself.
- When External Input Rotation is set to On, Multi Screen's PIP mode is disabled.
- If External Input Rotation is enabled on models that support touch, touch may not work properly.

[Mirror Mode]

- You can set this feature to rotate the screen through 180 degrees.

[Expert Controls]

SETTINGS / ⚙️ → [Display] → [Advanced Setting]

[UHD Deep Color]

If you connect an HDMI, DP, or OPS device to one of the Deep Color adjustable ports, you can select between UHD Deep Color On (6G) or Off (3G) in the UHD Deep Color settings menu.

If a compatibility issue occurs with a graphics card when the Deep Color option is set to On at 3840 x 2160 @ 60 Hz, set the Deep Color option back to Off.

- HDMI, DP, and OPS specifications may vary depending on the input port. Check the specifications of each device before connecting.
- HDMI input port 2 is best suited for high definition videos that are 4K@60 Hz (4:4:4, 4:2:2). However, video or audio may not be supported depending on the specifications of the external device. If this is the case, please connect the device to a different HDMI port.

[OLED Panel Settings]

- [Clear Panel Noise]: Correct issues that may arise when the screen is turned on for a long period of time.

[Energy Saving]

- [Smart Energy Saving]: Automatically adjust the brightness of the screen according to the brightness of the picture to save energy.
 - [On]: Enable the Smart Energy Saving feature.
 - [Off]: Disable the Smart Energy Saving feature.

! NOTE

- To revert to the default settings, either go to [Admin] → [Reset to Initial Settings] or [Admin] → [Factory Reset].
- [Brightness Control]: Adjust the brightness of the screen to save energy.
 - [Auto]: Automatically adjust the brightness of the screen according to ambient light.
 - [Off]: Disable energy saving.
 - [Minimum]/[Medium]/[Maximum]: Use energy saving according to the energy saving level set for the monitor.

! NOTE

- To revert to the default settings, either go to [Admin] → [Reset to Initial Settings] or [Admin] → [Factory Reset].
- [Brightness Scheduling]: Adjust the backlight at specified times.
 - You can set this feature to [On/Off].
 - Add schedule by setting the schedule time and backlight / OLED light value.
 - If the current time has not been set, [Brightness Scheduling] is disabled.
 - You can add up to six schedules, and they are sorted in ascending order by time.
 - You can edit a schedule by selecting it from the list and pressing the [OK] button.

! NOTE

- To revert to the default settings, either go to [Admin] → [Reset to Initial Settings] or [Admin] → [Factory Reset].
- [Screen Off]: Turn off the screen, meaning the TV only produces sound. You can turn on the screen again by pressing any button on the remote control except the power button.

[Adjust (RGB-PC)]

This feature enables you to configure the PC display options in RGB mode.

- [Set Automatically]: Automatically adjust the screen position, time, and phase. The image displayed on the screen can be unstable for a few seconds in the process of the configuration.
- [Resolution]: Choose between 1024 x 768, 1280 x 768 and 1360 x 768 resolution.
- [Position]/[Size]/[Phase]: Adjust the options when the picture is not clear, especially when characters are shaky, after the auto configuration.
- [Reset]: Resets the options to default.
- [Intelligent Auto]: Decides to run Auto Configuration on resolutions recognized for the first time by the RGB input.

[HDMI IT Contents]

Set the HDMI IT Contents function.

- [Off]: Disable the HDMI IT Contents function.
- [On]: Enable the HDMI IT Contents function.

This feature automatically changes the monitor's picture mode based on HDMI Contents information when an HDMI signal is entered.

Even if the monitor's picture mode has been changed by the HDMI IT Contents feature, you can change the picture mode again manually.

As this has a higher priority than the picture mode set by the user, the existing picture mode may be changed when the HDMI signal changes.

Sound

[Sound Mode]

SETTINGS / ⚙️ → [Sound] → [Sound Mode]

[Sound Mode]

The best sound quality will be selected automatically depending on the video type currently being watched.

- [Standard]: This sound mode works well for content of all types.
- [Cinema]: Optimize sound for watching movies.
- [Clear Voice III]: Enhance voices so they can be heard more clearly.
- [Sports]: Optimize sound for watching sports.
- [Music]: Optimize sound for listening to music.
- [Game]: Optimize sound for playing video games.

[Balance]

- [Balance]: Adjust the output volume for the left speaker and the right speaker.

[Equalizer]

- [Equalizer]: Manually adjust sound by using the equalizer.

[Reset]

- [Reset]: Resets sound settings.

[Sound Out]**SETTINGS / ⚙️** → [Sound] → [Sound Out]

- [Internal Speaker]/[External Speaker]: You can output audio either through your Signage monitor's internal speaker or through an external speaker connected to it.
- [SIMPLINK External Speaker]: This function connects Home Theater device by SIMPLINK. When it is set to Home Theater device input, it outputs voice through the connected device. This option is activated when SIMPLINK has been set to On.
- [LG Sound Sync]/[Bluetooth]: Enables you to connect Bluetooth audio devices or Bluetooth headsets wirelessly to your monitor so that you can enjoy richer audio conveniently.

! NOTE

- Some recently connected devices may automatically attempt to reconnect to the Signage monitor when it is turned on.
- It is recommended that you set LG audio devices that support LG Sound Sync to LG TV mode or LG Sound Sync mode before connecting.
- Press Device Selection to view the devices that are or that can be connected and connect other devices.
- You can use the signage remote control to adjust the volume of the connected device.
- If the audio device fails to connect, check that it is switched on and available for connection.
- Depending on the type of the Bluetooth device, the device may not connect correctly or an abnormal behavior may occur such as unsynchronized video and audio.
- Sound may stutter or sound quality may be reduced if:
 - The Bluetooth device is too far from the Signage monitor.
 - There is an obstructing object between the Bluetooth device and the Signage monitor.
 - The Bluetooth device is used together with radio equipment such as a microwave oven or wireless LAN.

[Audio Out]

SETTINGS / ⚙️ → [Sound] → [Audio Out]

- [Off]: Disables the use of Audio Out. (No audio outputted.)
- [Variable]: You can specify an output range for the external audio device connected to the monitor and adjust the volume within the range. You can change the volume of an external audio device within the range of 0 to 100 (the same as the Signage speaker volume). However, there may be a difference in the actual volume level outputted.
- [Fixed]: Set a fixed audio output level for the external audio device.
 - If there is no external input, no external audio is outputted.
 - The variable audio output level 100 is the same as the fixed audio output level.

[Volume Increase Amount]

SETTINGS / ⚙️ → [Sound] → [Volume Increase Amount]

This feature enables you to adjust the amount of volume that increases/decreases when you press the up/down volume key on your remote control. The higher the value you set, the faster the volume increases. Choose from among [Low], [Medium], and [High] to adjust the volume range.

[AV Sync. Adjust]

SETTINGS / ⚙️ → [Sound] → [AV Sync. Adjust]

This feature adjusts audio timing to synchronize video and audio.

- [External Speaker] (-5~15): Adjust the sync between video and audio coming from external speakers, such as those connected to the digital audio output port, LG audio equipment, or headphones. Moving closer to - speeds up the audio output, while moving closer to + slows down the audio output, compared to the default value.
- [Internal Speaker] (-5~15): Adjust the sync of sound from the internal speakers. Moving closer to - speeds up the audio output, while moving closer to + slows down the audio output, compared to the default value.
- [Bypass]: Output the broadcast signals or the sound from external devices without any audio delay. Audio may be outputted earlier than video due to the processing time for video that is inputted into the monitor.

[Digital Audio Input]

SETTINGS / ⚙️ → [Sound] → [Digital Audio Input]

This feature enables you to choose an input source for audio output.

- [Digital]: Output the audio contained in the digital signal inputted from the connected digital input source (HDMI, DISPLAYPORT, or OPS).
- [Analog]: Output audio from the digital input source (HDMI, DISPLAYPORT, or OPS) connected to the monitor through the Audio In port.

Admin

[Lock Mode]

SETTINGS / ⚙️ → [Admin] → [Lock Mode]

[Home Dashboard Lock]

This feature enables you to restrict changes made to dashboard lock settings on the Home screen.

[USB Lock]

This feature enables you to configure the USB lock feature so that settings or content cannot be changed.

[OSD Lock]

This feature enables you to configure the OSD lock feature so that settings or content cannot be changed.

- Press and hold the Settings key for at least 10 seconds and enter password to access the settings menu in OSD Lock.

[IR Operation Lock]

- If you set this feature to [Off (Normal)], you can use your remote control.
- If you set this feature to [On (Power Key Only)], you can only use the power key.
- If you set this feature to [On (Block All)], you cannot use your remote control. (However, Power On feature is available.)

[Local Key Operation Lock]

This feature enables you to configure the Local Key Operation Lock feature so that settings or content cannot be changed.

- If you set this feature to [Off (Normal)], you can use the local keys on the monitor.
- If you set this feature to [On (Power Key Only)], you can only use the power key. (When you use a joystick, press and hold a local key to turn on/off the monitor.)
- If you set this feature to [On (Block All)], you cannot use the local keys. (However, Power On feature is available.)

[Wi-Fi Lock]

This feature enables you to turn the Wi-Fi feature on or off.

[Screen Share Lock]

This feature enables you to turn the Screen Share feature on or off.

If the Screen Share Lock value is changed, the function is not applied without a reboot.

[Change PIN Code]

You can change the admin password.

- 1 Enter your current password.
- 2 Enter a new 4-digit password.
- 3 Enter the same password again in the Confirm Password field for confirmation.

[Enterprise Settings]

- Enter your company account code to apply the corresponding enterprise settings.
- When your code has been entered, the monitor set gets reset, thereby applying the corresponding enterprise settings.
- This feature does not get activated if a code has already been entered.

[Reset to Initial Settings]

Resets all items except for the Q Start items (functions related to the language, screen direction, external input, time, and power) and other items to their initial settings.

[Factory Reset]

This feature resets the items applicable for Reset to Initial Settings, Date, Time, Language, Network IP, and the Input Label Internal Storage files.

However, Calibration mode's RGB gain is an exception.

NOTE

- It keeps the existing settings because the Off / On button in the User menu only affects the active / inactive status of the submenu.

CONTENT MANAGER

Web Login

- Different features are supported depending on the product.
- This Signage product comes with a feature that enables you to access it on your PC or mobile device.
- Content Manager, Group Manager 2.0, Control Manager, Log Out, Change Password menus are provided.
 - URL: <https://set ip:3777>
 - The initial password can be found at **HOME / ↑ → [MOBILE URL] menu.**

CAUTION

- Supported resolutions (this program is optimized for the following resolutions):
 - PC: 1920 x 1080, 1280 x 1024
 - Mobile: 360 x 640 (1440 x 2560, 1080 x 1920), DPR
- Supported browsers (this program is optimized for the following browsers):
 - Chrome 56 or later (recommended)
- For security purposes, please change the password after logging in with the initial password.
- After the initial password has been changed, it will no longer be shown on **HOME / ↑ → [MOBILE URL] menu.**

Content Manager

[Player]

HOME / ↑ →  [Player]

The Content Manager app's player feature enables you to play and manage video content, image content, template content, SuperSign content, and playlist content in an integrated way. (The OLED models do not support the playback and management of image content and template content.)

[Continuous Play]

- 1 Select your desired type of content from the tab on the left and then select your desired content.
- 2 Click [Play] in the upper right-hand corner of the screen and enjoy the content you have selected.

[Export]

- 1 Select your desired type of content from the tab on the left and click [Export] in the upper right-hand corner of the screen.
- 2 Select the content you wish to export.
- 3 Click [Copy]/[Move] in the upper right-hand corner of the screen and select the device to which you wish to export the content. (If a content file stored on the target device has been selected, the processing of the content file is skipped.)
- 4 You can see that the content has been moved/copied to the device.

[Delete]

- 1 Select your desired type of content from the tab on the left and click [Delete] in the upper right-hand corner of the screen.
- 2 Select the content you wish to delete.
- 3 Click [Delete] in the upper right-hand corner of the screen.
- 4 You can see that the content has been deleted.

[Filter / Sort]

- 1 Click [Filter / Sort] in the upper right-hand corner of the screen.
- 2 1) Choose your desired sort criterion to sort content files either by file name or in the order they have been played (the most recently played file shown at the top of the list).
2) It is possible to only view the content stored on your desired device by filtering content files by device.
3) It is possible to only view the content of your desired type by filtering content files by content type.

[Create Playlist]

When creating a playlist, you cannot include characters that cannot be used in file names on Windows — such as \, /, ;, *, ?, ", <, >, and | — in the names of the files in the playlist. In addition, if the playlist contains content files whose names include such characters, you cannot move or copy the playlist.

- 1 Select [Playlist] from the tab on the left and click [Create Playlist] in the upper right-hand of the screen.
- 2 Select the content you wish to add to the playlist and click [Next] in the upper right-hand of the screen.
- 3 Set a play time for each piece of content (applicable only for photo and template content), as well as other items such as Conversion Effect, Ratio, and Auto Playback, and then click "Done" button in the upper right-hand corner of the screen.
- 4 You can see a new [Playlist] has been created.

[Scheduler]

HOME /  →  [Scheduler]

The Content Manager app's scheduler feature enables certain content to be played at a scheduled time through a playlist or external input.

[Creating a Schedule]

- 1 Click [New Schedule] in the upper right-hand corner of the screen.
- 2 Choose between [Playlist] and [Input Source].
- 3 1) If you have selected [Playlist], select the playlist you wish to schedule the playback of.
2) If you have selected [Input Source], select the external input source you wish to schedule the playback of.
- 4 Enter schedule information and create a new schedule. (When creating a schedule, you cannot include characters that cannot be used in file names on Windows — such as \, /, ;, *, ?, ", <, >, and | — in the name of the schedule file. In addition, if the playlist linked to the schedule contains content files whose names include such characters, you cannot move or copy the playlist.)
- 5 Watch the playlist or external input you selected play back at its scheduled time.

[Importing a Schedule]

- 1 Click [Import] in the upper right-hand corner of the screen.
- 2 Select the external storage device from which you wish to import a schedule.
- 3 Select the schedule you wish to import to your monitor. (You can only choose a single schedule.)
- 4 Click [Select] in the upper right-hand corner of the screen.
- 5 Check that the schedule has been imported to the monitor's internal storage memory.

[Exporting a Schedule]

- 1 Click [Export] in the upper right-hand corner of the screen.
- 2 Select the external storage device to which you wish to export a schedule.
- 3 Select the schedule you wish to export from your monitor. (You can choose multiple schedules.)
- 4 Click [Select] in the upper right-hand corner of the screen.
- 5 Check that the schedule has been exported to the external storage device you selected.

[Deleting a Schedule]

- 1 Click [Delete] in the upper right-hand corner of the screen.
- 2 Select the schedules you wish to delete.
- 3 Click [Delete].
- 4 Check that the schedules have been deleted.

[Calendar View]

- 1 When you have registered schedules, click [Calendar View].
- 2 You can see that the schedules registered are displayed in the form of a timetable.

! NOTE

- If the schedule creation time overlaps, the previously created schedule is deleted.
- When a schedule that has not been set repeatedly is completed, the schedule is automatically deleted.
- Schedule does not work while Scheduling list app is running.

[Editor]

HOME /  →  [Editor]

The Content Manager app's editor feature enables you to add your desired templates.

- 1 Select the template of your desired format. (You can choose between Landscape mode and Portrait mode.)
- 2 Modify the template's text.
2-1. Apply your desired font style (text size, text thickness, underline, and italic).
- 3 Modify the media file.
- 4 Save the template by clicking [Save] in the top right-hand corner of the screen.
- 5 Check that the template you saved is shown in the template list.

[Supported Photo & Video Files]**! NOTE**

- Subtitles are not supported.
- The photo feature is not supported in OLED models.

Supported video codecs

Extension	Codec	
.asf, .wmv	Video	VC-1 Advanced Profile (except for WMVA), VC-1 Simple and Main Profiles
	Audio	WMA Standard (excluding WMA v1/WMA Speech)
.avi	Video	Xvid (excluding 3 warp-point GMC), H.264/AVC, Motion Jpeg, MPEG-4
	Audio	MPEG-1 Layer I, II, MPEG-1 Layer III (MP3), Dolby Digital, LPCM, ADPCM, DTS
.mp4, .m4v, .mov	Video	H.264/AVC, MPEG-4, HEVC
	Audio	Dolby Digital, Dolby Digital Plus, AAC, MPEG-1 Layer III (MP3)
.3gp	Video	H.264/AVC, MPEG-4
.3g2	Audio	AAC, AMR-NB, AMR-WB
.mkv	Video	MPEG-2, MPEG-4, H.264/AVC, VP8, VP9, HEVC
	Audio	Dolby Digital, Dolby Digital Plus, AAC, PCM, DTS, MPEG-1 Layer I, II, MPEG-1 Layer III (MP3)
.ts, .trp, .tp, .mts	Video	H.264/AVC, MPEG-2, HEVC
	Audio	MPEG-1 Layer I, II, MPEG-1 Layer III (MP3), Dolby Digital, Dolby Digital Plus, AAC, PCM
.mpg, .mpeg, .dat	Video	MPEG-1, MPEG-2
	Audio	MPEG-1 Layer I, II, MPEG-1 Layer III (MP3)
.vob	Video	MPEG-1, MPEG-2
	Audio	Dolby Digital, MPEG-1 Layer I, II, DVD-LPCM

Maximum transmit ratio

Full HD movie	1920 x 1080: 20Mbps(Mega bit per second) H.264 1920 x 1080@60P BP/MP/HP@L4.2 40Mbps HEVC 1920 x 1080@60P MP@L4.1, Main10 Profile@L4.1 40Mbps
ULTRA HD movie (UHD models only.)	H.264 1920 x 1080@60P 4096 x 2160@30P BP/MP/HP@L5.1 50Mbps HEVC 4096 x 2160@60P MP@L5.1, Main10 Profile@L5.1 50Mbps

Supported Photo File Formats

File type	Format	Resolution
.jpeg, .jpg, .jpe	JPEG	<ul style="list-style-type: none"> • Min: 64 x 64 • Max <ul style="list-style-type: none"> - Normal Type: 15360(W) x 8640(H) - Progressive Type: 1920(W) x 1440(H)
.png	PNG	<ul style="list-style-type: none"> • Min: 64 x 64 • Max: 5760 (W) x 5760 (H)
.bmp	BMP	<ul style="list-style-type: none"> • Min: 64 x 64 • Max: 1920 (W) x 1080 (H)

Tips for using USB storage devices

- Only USB storage devices are recognized.
- USB storage devices connected to the monitor through a USB hub may not work properly.
- USB storage devices that use an automatic recognition program may not be recognized.
- USB storage devices that use their own drivers may not be recognized.
- The recognition speed of a USB storage device may depend on each device.
- Please do not turn off the display or unplug the USB device when the connected USB storage device is working. When the device is suddenly separated or unplugged, the stored files or the USB storage device may be damaged.
- Please do not connect the USB storage device which was artificially maneuvered on the PC. The device may cause the product to malfunction or fail to be played. Remember to only use USB storage devices that store normal music, image, and/or movie files.
- Storage devices formatted with utility programs that are not supported by Windows may not be recognized.
- Please connect power to a USB storage device (over 0.5 A) which requires an external power supply. Otherwise, the device may not be recognized.
- Please connect a USB storage device with the cable offered by the device maker.
- Some USB storage devices may not be supported or operated smoothly.
- File alignment methods of the USB storage device is similar to Windows XP and filenames can include up to 100 English characters.
- Be sure to back up important files since data stored in a USB memory device may be damaged. We will not be responsible for any data loss.
- If the USB HDD does not have an external power source, the USB device may not be detected. So make sure to connect it to an external power source.
 - Please use a power adapter for an external power source. No USB cable is provided for an external power source.

- If your USB storage device has multiple partitions, or if you use a USB multi-card reader, you can use up to four partitions or USB memory devices.
- If a USB storage device is connected to a USB multi-card reader, its volume data may not be detected.
- If the USB storage device does not work properly, remove it and connect it again.
- The speed at which a USB storage device is detected differs from device to device.
- If the USB storage device is connected in Standby Mode, a specific hard disk will automatically be loaded when the display is turned on.
- The recommended capacity is 1 TB or less for a USB external hard disk and 32 GB or less for USB memory.
- Any device with more than the recommended capacity may not work properly.
- If a USB external hard disk with a [Energy Saving] feature does not work, turn the hard disk off and on again to make it work properly.
- USB storage devices (USB 2.0 or below) are also supported. However, they may not work properly in the videos list.
- A maximum of 999 folders or files can be recognized under one folder.

Group Manager 2.0

This feature enables you to group together multiple monitor sets on a single network into the same group and to distribute content (schedules and playlists) or copy setting data on a group basis. This feature has two modes, Master and Slave, and it can access the browser on your PC or mobile device.

Master

- Add, edit, and delete group.
- Clone your device's settings data.
- Distribute [Schedule] and [Playlist] on a group basis.
- All monitor sets initially come in Master mode.

Slave

- Play [Schedule] and [Playlist] distributed in Master mode.
- Remove monitor sets for their groups.
- Monitor sets that have been added to a group are automatically switched to Slave mode. Conversely, when a monitor set has been deleted from a group, it is automatically initialized and switched to Master mode.
- If a new Slave has been added to an existing group, or if the [Data Cloning] or the distribution of [schedule] / [Playlist] has not been properly performed, the [Data Cloning] or [SYNC] button will be activated.
- You can duplicate the master device's setting data to the group by using [Data Cloning].
- You can re-download the content distributed to the group by using [Sync].

[Group Management]

- Creating a New Group
 1. Click [Add New Group].
 2. Enter a group name.
 3. Click [Add Device], select the devices you wish to add to the group, and add them.
 4. Click [Done], and you will see that a new group has been created.
- Editing a Group
 1. Click the group you wish to edit.
 2. Add a new device by using [Add Device].
 3. Delete a device by using [Delete Device].
 4. Check whether the devices in the group are connected to a network by using [Device Check].
 5. If there are any sets of devices in the group that are not [Data Cloning] or content synchronized, [Data Cloning] or [SYNC] button will be activated.
 6. You can re-copy the master device's setting data to the group by using [Data Cloning].
 7. You can re-distribute the content distributed to the group by using [Sync].
- Deleting a Group
 1. Click [Delete Group].
 2. Select the group you wish to delete and click [Delete].
 3. Check that the group you selected has been deleted.
- All Devices View: This page enables you to manage all slave monitor sets that are connected to the same network.
 1. Click [All Devices View].
 2. Click [Reset Device Mode].
 3. Select the slave monitor set whose device mode you wish to change and click [Reset].

[Setting Data Cloning]

- 1 Select your desired group and click [Clone].
- 2 Check that the data have been copied on the slave sets.

[Content Distribution]

- 1 Select the type of content you wish to distribute (Schedules or Playlists).
- 2 Select the content you wish to distribute.
- 3 Select the group to which you wish to distribute the content and click [Distribute].
- 4 Run the Content Manager app on the slave sets and check that the content has been distributed.

How to Use

- Monitors: Run/add/delete/edit apps in the Launcher bar.
- Mobile devices: Run the app in the Launcher bar or access the app from a mobile device using the QR code or URL provided.

CAUTION

- You can create up to 25 groups.
- You can add up to 12 slave devices to a group.
- You can distribute the schedules stored on external devices after executing Content Manager's import operation.
- Make sure to delete all schedules stored on the slave sets before distributing any schedules.
- A list of devices you can add to your desired group appears only when the following conditions have been met:
 - The devices you wish to add must be on the same network as the master device.
 - The devices you wish to add must be in Master mode, and they must not belong to any existing group.
 - The UPnP feature must be enabled (go to [General] > [Network] > UPnP and set it to [On]).
- Group Manager 2.0 may not work properly in wireless network environments. It is recommended you use a wired network.
- Run the initial settings for Slave function when deleting the group.

ScreenShare

This feature allows the screen of a user's device such as a mobile or PC Windows to be shared with a display using a wireless connection such as WiDi or Miracast.

[How to Use ScreenShare]

INPUT /  → 

- 1 Connect according to the instructions provided by the guide that can be accessed through the CONNECTION GUIDE button in the upper right.
- 2 Once the connection is established, Screen Share between the user device and the monitor is enabled.

! NOTE

- For information on how to use Intel WiDi, visit PC/laptop manufacturer webpage or <http://intel.com/go/widi>.
- This feature only works properly with WiDi 3.5 or later versions.
- This feature only works on Windows 8.1 or later

MANAGEMENT TOOLS

Control Manager

Control and check the status of the display through the Web browser.

This function is available for PCs and mobile devices.

Different features are supported depending on the product.

Function

- [Dashboard]: Display a summary of the product's status and provides links to each page.
- [Display] and [Sound]: Provides features such as Screen Brightness, Sound, Input, and Reboot.
- [Time & Date]: Enable/disable Set Automatically feature and displays/changes the time set for the product.
- [Network]: Set the name and IP address of your Signage monitor.
- [Screen Fault Detection]: Display the video output status of the product.
- [Tile Mode]: Display the tile mode settings of the product.
- [Fail Over]: Turns the Fail Over feature on or off and sets related items.
- [Play via URL]: Turn Play via URL on or off and set URLs.
- [Software Update]: Update the firmware of the product.
- [Charts]: Output the product's status information such as its temperature and fan status.
- [Logs]: Output product malfunction records.
- [System Information]: Output information such as the product's software version and model name.

! NOTE

- When [Screen Rotation] [On] is set to On, [Screen Fault Detection] does not work.

Picture ID

[Picture ID] is used to change the settings of a specific set (display) using a single IR receiver for multi-vision. Communication is possible between a monitor with an IR receiver and other monitors using RS-232C cables. Each monitor is identified by a Set ID. Setting [Picture ID] allows you to only use the remote control with monitors with a [Set ID] that matches the [Picture ID].

- 1 Assign [Set ID] to the installed monitors as shown below:

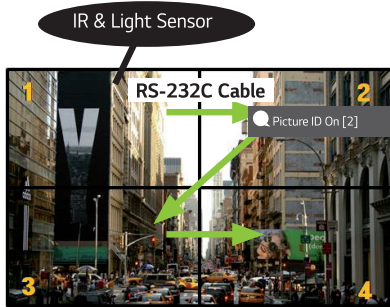

- 2 Press the red [Picture ID] [On] button on the remote control.
- 3 Make sure that the Picture ID you set is identical to the [Set ID] of the monitor you wish to control.
 - A set with a [Set ID] that is different from the [Picture ID] cannot be controlled by IR signals.

! NOTE

- If [Picture ID] has been set to 2, only the upper right monitor, which has a [Set ID] of 2, can be controlled by IR signals.
- If you press the green [Picture ID] [Off] button on your remote control, the [Picture ID] for all monitors are turned off. If you then press any button on the remote control, all monitors can be controlled by IR signals regardless of their [Set ID]'s.

TOUCH













Touch Assistive Menu

This touch-exclusive feature allows the user to configure settings without a remote control.

Touching the screen for a certain period of time or pressing the "Touch Assistive Menu" local key brings up the Touch Assistive Menu on the screen.

Different features are supported depending on the product.

Function

-  [Home]: Navigates to the Home screen.
-  [Reader Mode]: A mode with low blue light, which lessens strain on the eyes when reading text.
-  [Local Key Lock]: Configures the product button (local key) lock function.
-  [External Input]: Navigates to the external input selection screen.
-  [Settings]: Navigates to the Settings screen.
-  [IDB]: Run IDB
-  [Player]: Run player
-  [SI]: Go to SI App Selection screen
 -  : Run SI Apps installed with ZIP Type
 -  : Run SI Apps installed with IPK Type
 -  : Go to Developer Mode
 -  : Go to SI Server Setting

IDB (Interactive Digital Board)

- This feature may not be available on some models.
- Different features are supported depending on the product.

This feature provides writing function. To run IDB, press the  (IDB) button or the local key IDB button on the Touch Assistive Menu.

Function









- When running IDB, a blank screen appears, and you can use Touch to draw.
- When you touch the circle icon in the center of the screen, or keep in contact with any part of the screen for a certain period, the circular menu will expand and appear.
- Press the center of the expanded circle menu to change it to a small icon. You can move the position by dragging the middle part.
- In the circular menu, you can change the pen type and color, and you can erase, revert, and select regions.
- Touch the left or right arrows on the screen to display the full menu and you can delete all screens or save the current screen as a file in the internal storage or external storage.
- You can turn Multi-touch On and Off in the full menu setting. When the Multi-touch function is turned on, the Zoom button appears and when the Multi-touch function is off, you can zoom in and out using two fingers.
- Exit IDB with the Exit button in the full menu setting.
- To connect to a network, press the Start button on IDB and run IDB Duo on the PC that is connected to the same router as the touch model. Then, enter the 6-digit token displayed on IDB.
- To display a video connected to a network or external input cable, select the corresponding item in Pair from the full menu.
- If you touch the screen while a connected video is being displayed, the Markup Mode button will appear. Switching to the Markup Mode allows you to capture the full screen to write on it and save it.

! NOTE

- Files stored in IDB's internal storage are deleted upon closing IDB.
- IDB does not enable keys except for Volume and Power keys.
- When Screen Touch is set to Off, IDB is unavailable.
- IDB is unavailable when Screen Rotation is enabled.
- Using multiple Touch pens and fingers at the same time, or using Eraser may slow down your work.

IR CODE

- All models do not support the HDMI/USB function.
- Some key codes may not be supported depending on the model.

Code (Hex)	Function	Remarks
08	 (Power)	Remote control button
C4	MONITOR ON	Remote control button
C5	MONITOR OFF	Remote control button
95	ENERGY SAVING	Remote control button
0B	INPUT (Select input)	Remote control button
10	Number Key 0	Remote control button
11	Number Key 1	Remote control button
12	Number Key 2	Remote control button
13	Number Key 3	Remote control button
14	Number Key 4	Remote control button
15	Number Key 5	Remote control button
16	Number Key 6	Remote control button
17	Number Key 7	Remote control button
18	Number Key 8	Remote control button
19	Number Key 9	Remote control button
02	 (Vol +)	Remote control button
03	 (Vol -)	Remote control button
E0	Brightness  (Page Up)	Remote control button
E1	Brightness  (Page Down)	Remote control button
DC	 (3D)	Remote control button
32	1/a/A	Remote control button
2f	CLEAR	Remote control button
7E	 SIMPLINK	Remote control button
79	ARC (Mark/Aspect Ratio)	Remote control button
4D	PSM (Picture Mode)	Remote control button
09	 (MUTE)	Remote control button

Code (Hex)	Function	Remarks
43	⚙️ (Settings/Menu)	Remote control button
99	Auto Configuration	Remote control button
40	⤴ (Up)	Remote control button
41	⤵ (Down)	Remote control button
06	➤ (Right)	Remote control button
07	⤵ (Left)	Remote control button
44	Ⓞ OK (OK)	Remote control button
28	↶ (BACK)	Remote control button
7B	Tile	Remote control button
5B	Exit	Remote control button
72	Picture ID On (Red)	Remote control button
71	Picture ID Off (Green)	Remote control button
63	Yellow	Remote control button
61	Blue	Remote control button
5F	W.Bal	Remote control button
3F	⌘ (S.Menu)	Remote control button
7C	🏠 (Home)	Remote control button
97	Swap	Remote control button
96	Mirror	Remote control button

CONTROLLING MULTIPLE PRODUCTS

- This only applies to certain models.

Use this method to connect several products to a single PC. You can control several products at a time by connecting them to a single PC.

In the Option menu, the Set ID must be between 1 and 1000 without being duplicated.

Connecting cables

- The image may be different according to the model.

Connect the RS-232C cable as shown in the picture.

The RS-232C protocol is used for communication between the PC and product. You can turn the product on/off, select an input source and adjust the OSD menu from your PC.

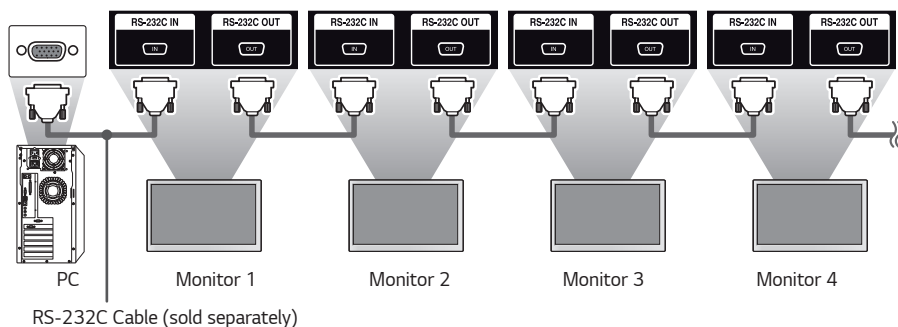
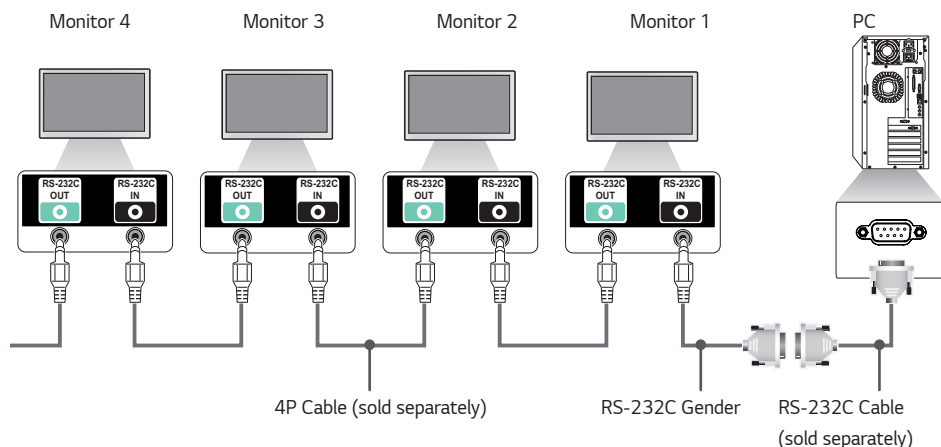

Communication Parameter

Baud Rate: 9600 bps

Data Length: 8 bits

Parity Bit: None

Stop Bit: 1 bit

Flow Control: None

Communication Code: ASCII code

! NOTE

- When using 3-wire connections (non-standard), an IR daisy chain cannot be used.
- Be sure to only use the provided gender to connect properly.
- When you have daisy-chained multiple Signage products to control them simultaneously, if you attempt to turn on/off the master device in a continuous manner, some products may not turn on. In this case, you can turn those monitors on by pressing the "MONITOR ON" button, not the Power button.

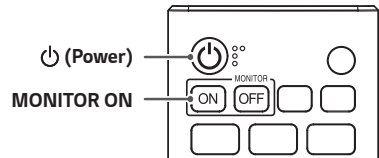

Command Reference List

		Command		Data (Hexadecimal)
		1	2	
01	[Power]	k	a	00 to 02
02	[Select input]	x	b	See [Select Input]
03	[Aspect Ratio]	k	c	See [Aspect Ratio]
04	[Brightness Control]	j	q	See [Brightness Control]
05	[Picture Mode]	d	x	See [Picture Mode]
06	[Contrast]	k	g	00 to 64
07	[Brightness]	k	h	00 to 64
08	[Sharpness]	k	k	00 to 32
09	[Color]	k	i	00 to 64
10	[Tint]	k	j	00 to 64
11	[Color Temperature]	x	u	70 to D2
12	[Balance]	k	t	00 to 64
13	[Sound Mode]	d	y	See [Sound Mode]
14	[Mute]	k	e	00 to 01
15	[Volume Control]	k	f	00 to 64
16	[Clock] 1 (year/month/day)	f	a	See [Clock] 1
17	[Clock] 2 (hour/minute/second)	f	x	See [Clock] 2
18	[No Signal Power Off (15 Min)]	f	g	00 to 01
19	[Auto Power Off]	m	n	00 to 01
20	[Language]	f	i	See [Language]
21	Set [Default]	f	k	00 to 02
22	Current Temperature	d	n	FF
23	[Key]	m	c	See [Key]
24	Time Elapsed	d	l	FF
25	Product Serial Number	f	y	FF

		Command		Data (Hexadecimal)
		1	2	
26	Software Version	f	z	FF
27	[White Balance] Red Gain	j	m	00 to FE
28	[White Balance] Green Gain	j	n	00 to FE
29	[White Balance] Blue Gain	j	o	00 to FE
30	[White Balance] Red Offset	s	x	00 to 7F
31	[White Balance] Green Offset	s	y	00 to 7F
32	[White Balance] Blue Offset	s	z	00 to 7F
33	[Backlight]	m	g	00 to 64
34	[Screen Off]	k	d	00 to 01
35	[Tile Mode]	d	d	00 to FF
36	Check [Tile Mode]	d	z	FF
37	[Tile ID]	d	i	See [Tile ID]
38	[Natural Mode]	d	j	00 to 01
39	[DPM (Standby Mode)]	f	j	See [DPM (Standby Mode)]
40	Remote Control/Local Key Lock	k	m	00 to 01
41	[Power On Delay]	f	h	00 to FA
42	[Fail Over] Select	m	i	00 to 02
43	[Fail Over] Input Select	m	j	See [Fail Over] Input Select
44	Remote Controller Key Lock	t	p	00 to 02
45	[Local Key Lock]	t	o	00 to 02
46	Check [Status]	s	v	See Check [Status]
47	[Screen Fault Detection]	t	z	00 to 01
48	[Daylight Saving Time]	s	d	See [Daylight Saving Time]
49	[PM Mode]	s	n, 0c	00 to 03
50	[ISM Method]	j	p	See [ISM Method]

		Command		Data (Hexadecimal)
		1	2	
51	[Network Settings]	s	n, 80(81)(82)	See [Network Settings]
52	[Auto Configuration]	j	u	01
53	[H Position]	f	q	00 to 64
54	[V Position]	f	r	00 to 64
55	[H Size]	f	s	00 to 64
56	[Power On Status]	t	r	00 to 02
57	Wired [Wake On LAN (Networked standby mode)]	f	w	00 to 01
58	[Intelligent Auto]	t	i	00 to 01
59	[OSD Rotation]	t	h	00 to 02
60	[Time Sync]	s	n, 16	00 to 01
61	[Content Sync]	t	g	00 to 01
62	[LAN Daisy Chain]	s	n, 84	00 to 01
63	[Content Rotation]	s	n, 85	00 to 02
64	[Scan Inversion]	s	n, 87	00 to 01
65	[Beacon]	s	n, 88	00 to 01
66	[Brightness Scheduling] Mode	s	m	00 to 01
67	[Brightness Scheduling]	s	s	See [Brightness Scheduling]
68	[Multi Screen] Mode & Input	x	c	See [Multi Screen] Mode & Input
69	[Aspect Ratio] (Multi Screen)	x	d	See [Aspect Ratio] (Multi Screen)
70	[Screen Off] (Multi Screen)	x	e	See [Screen Off] (Multi Screen)
71	[Screen Off Always]	s	n, 0d	00 to 01
72	Screen Video Freeze	k	x	00 to 01
73	Wireless [Wake On LAN (Networked standby mode)]	s	n, 90	00 to 01
74	OSD Lock	k	l	00 to 01

		Command		Data (Hexadecimal)
		1	2	
75	[HDMI IT Contents]	s	n, 99	00 to 01
76	[On/Off Time Scheduling]	s	n, 9a	See [On/Off Time Scheduling]
77	[Holiday Setting]	s	n, 9b	See [Holiday Setting]
78	[UPnP] Mode	s	n, 9c	00 to 01
79	[Home Dashboard Lock]	s	n, 9d	00 to 01
80	[USB Lock]	s	n, 9e	00 to 01
81	[Wi-Fi Lock]	s	n, 9f	00 to 01
82	[Screen Share Lock]	s	n, a0	00 to 01
83	[Backup via Storage]	s	n, a1	See [Backup via Storage]
84	[Digital Audio Input]	s	n, a2	00 to 01
85	[Bootring Logo Image]	s	n, a3	00 to 01
86	[SoftAP] Mode	s	n, a4	00 to 01
87	[Natural Size]	s	n, a5	00 to 64
88	[Clear Panel Noise]	s	n, a6	01
89	[Change PIN Code]	s	n, a7	See [Change PIN Code]
90	Play Internal Storage Media	s	n, a8	Play Internal Storage Media
91	[No Signal Image]	s	n, a9	00 to 01
92	[Audio Out]	s	n, aa	00 to 02
93	[DPM (Standby Mode) Wake Up Control]	s	n, 0b	00 to 01
94	Fan Failure Check	d	w	FF
95	[Apply to all inputs]	s	n, 52	01
96	[Frame Control]	s	n, b7	00 to 01
97	Multichannel	s	n, 76	01 to 09

* Note: Commands may not work when there is no external input used.

* Some commands may not be supported on some models.

Transmission/Reception Protocol

Transmission

(Command1)(Command2)()(Set ID)()(Data)(Cr)

- * (Command1): Identifies between the factory setting and the user setting modes.
- * (Command 2): This command is used to control the monitor.
- * (Set ID): Used for selecting a set you want to control. A unique Set ID can be assigned to each set ranging from 1 to 1000 (01H to FFH) under Settings in the OSD menu. Selecting '00H' for Set ID allows the simultaneous control of all connected monitors. (The maximum value may differ depending on the model.)
- * (Data): Transmits command data. Data count may increase depending on the command.
- * (Cr): Carriage Return. This parameter corresponds to '0 x 0D' in ASCII code.
- * (): White Space. This parameter corresponds to '0 x 20' in ASCII code.

Acknowledgment

(Command2)()(Set ID)()(OK/NG)(Data)(x)

- * The product transmits an ACK (acknowledgment) based on this format when receiving normal data. At this point, if the data is FF, it indicates the present status data. If the data is in data write mode, it returns the data of the PC computer.
- * If a command is sent with Set ID '00' (= 0 x 00), the data is reflected to all monitors and they do not send an acknowledgment (ACK).
- * If you send "FF" as the value of the data in control mode via RS-232C, you can check the value currently set for the relevant feature (not applicable to some features).
- * Some commands may not be supported on some models.

01. [Power] (Command: k a)

Controls the power on/off status of the monitor.

Transmission

(k)(a)()([Set ID])() (Data)(Cr)

Data 00: [Off]

01: [On]

02: [Reboot]

Acknowledgment

(a)()([Set ID])() (OK/NG)(Data)(x)

- * The Acknowledgment signal is returned properly only when the monitor is fully powered on.
- * There may be a delay between the Transmission and Acknowledgment signals.
- * This feature may not be supported on some models.

02. [Select Input] (Command: x b)

Selects an input signal.

Transmission

(x)(b)()([Set ID])() (Data)(Cr)

Data 20: AV

40: COMPONENT

60: RGB

70: DVI-D (PC)

80: DVI-D (DTV)

90: HDMI1 (DTV)

A0: HDMI1 (PC)

91: HDMI2/OPS (DTV)

A1: HDMI2/OPS (PC)

92: OPS/HDMI3/DVI-D (DTV)

A2: OPS/HDMI3/DVI-D (PC)

95: OPS/DVI-D (DTV)

A5: OPS/DVI-D (PC)

96: HDMI3/DVI-D (DTV)

A6: HDMI3/DVI-D (PC)

97: HDMI3/HDMI2/DVI-D (DTV)

A7: HDMI3/HDMI2/DVI-D (PC)

98: OPS (DTV)

A8: OPS (PC)

C0: DISPLAYPORT (DTV)

D0: DISPLAYPORT (PC)

E0: SuperSign webOS Player

E1: Others

E2: Multi Screen

E3: Play via URL

Acknowledgment

(b)()([Set ID])() (OK/NG)(Data)(x)

- * Some input signals may not be available with certain models.
- * webOS Player is processed as NG when the content is not saved.

03. [Aspect Ratio] (Command: k c)

Adjusts the aspect ratio of your monitor.

Transmission

(k)(c)()([Set ID])() (Data)(Cr)

Data 02: [Full Wide]

06: [Original]

Acknowledgment

(c)()([Set ID])() (OK/NG)(Data)(x)

- * The aspect ratio may differ depending on the model's input configuration.

04. [Brightness Control] (Command: j q)

Sets the brightness of your monitor.

Transmission

(j)(q)()([Set ID])() (Data)(Cr)

Data 00: [Off]

01: [Minimum]

02: [Medium]

03: [Maximum]

04: [Automatic]

05: [Screen Off]

Acknowledgment

(q)()([Set ID])() (OK/NG)(Data)(x)

- * This feature may not be supported on some models.

05. [Picture Mode] (Command: d x)

Selects a picture mode.

Transmission

(d)(x)()([Set ID])() (Data)(Cr)

Data 00: [Mall/QSR]

01: [General]

02: [Gov./Corp.]

03: [Transportation]

04: [Education]

05: [Expert 1]

06: [Expert 2]

08: [Auto Power Save]

09: [Photo]

11: [Calibration]

Acknowledgment

(x)()([Set ID])() (OK/NG)(Data)(x)

- * Depending on the model, some picture modes may not be supported.

06. [Contrast] (Command: k g)

Adjusts the screen contrast.

Transmission

(k)(g)()([Set ID])() (Data)(Cr)

Data 00-64: [Contrast] 0-100

Acknowledgment

(g)()([Set ID])()(OK/NG)(Data)(x)

09. [Color] (Command: k i)

Adjusts the screen colors.

Transmission

(k)(i)()([Set ID])() (Data)(Cr)

Data 00-64: [Color] 0-100

Acknowledgment

(i)()([Set ID])()(OK/NG)(Data)(x)

07. [Brightness] (Command: k h)

Adjusts the screen brightness.

Transmission

(k)(h)()([Set ID])() (Data)(Cr)

Data 00-64: [Brightness] 0-100

Acknowledgment

(h)()([Set ID])()(OK/NG)(Data)(x)

10. [Tint] (Command: k j)

Adjusts the screen tints.

Transmission

(k)(j)()([Set ID])() (Data)(Cr)

Data 00-64: [Tint] Red 50-Green 50

Acknowledgment

(j)()([Set ID])()(OK/NG)(Data)(x)

08. [Sharpness] (Command: k k)

Adjusts the screen sharpness.

Transmission

(k)(k)()([Set ID])() (Data)(Cr)

Data 00-32: [Sharpness] 0-50

Acknowledgment

(k)()([Set ID])()(OK/NG)(Data)(x)

11. [Color Temperature] (Command: x u)

Adjusts the screen color temperature.

Transmission

(x)(u)()([Set ID])() (Data)(Cr)

Data 70-D2: 3200K-13000K

Acknowledgment

(u)()([Set ID])()(OK/NG)(Data)(x)

* This feature may not be supported on some models.

12. [Balance] (Command: k t)

Adjusts the sound balance.

Transmission**(k)(t)()([Set ID])()(Data)(Cr)**

Data 00-64: Left 50-Right 50

Acknowledgment**(t)()([Set ID])()(OK/NG)(Data)(x)**

* This feature may not be supported on some models.

13. [Sound Mode] (Command: d y)

Selects a sound mode.

Transmission**(d)(y)()([Set ID])()(Data)(Cr)**

Data 01: [Standard]

02: [Music]

03: [Cinema]

04: [Sports]

05: [Game]

07: [News] ([Clear Voice III])

Acknowledgment**(y)()([Set ID])()(OK/NG)(Data)(x)**

* This feature may not be supported on some models.

14. [Mute] (Command: k e)

Mutes/unmutes audio.

Transmission**(k)(e)()([Set ID])()(Data)(Cr)**

Data 00: Quiet (Sound Off)

01: Current Volume Level (Sound On)

Acknowledgment**(e)()([Set ID])()(OK/NG)(Data)(x)**

* This feature may not be supported on some models.

15. [Volume Control] (Command: k f)

Adjusts the playback volume.

Transmission**(k)(f)()([Set ID])()(Data)(Cr)**

Data 00-64: [Volume] 0-100

Acknowledgment**(f)()([Set ID])()(OK/NG)(Data)(x)**

* This feature may not be supported on some models.

16. [Clock] 1 (year/month/day) (Command: f a)

Sets the Clock 1 (year/month/day) values and Auto Time.

Transmission**1. (f)(a)()([Set ID])()(Data1)()(Data2)()(Data3)(Cr)****2. (f)(a)()([Set ID])()(0)(0)()(Data1)(Cr)**

1. When setting Clock 1 (year/month/day)

Data1 00-: 2010-

Data2 01-0C: January to December

Data3 01-1F: 1st-31st

* The minimum and maximum values for Data1 differ depending on the product's release year.

* Enter "fa [Set ID] ff" to view Clock 1 (year/month/day) settings.

2. When Setting Auto Time

Data1 00: Auto

01: Manual

* To view the set value of the Auto time, enter "fa [Set ID] 00 ff".

Acknowledgment**1. (a)()([Set ID])()(OK/NG)(Data1)(Data2)(Data3)(x)****2. (a)()([Set ID])()(OK/NG)(0)(0)(Data1)(x)**

17. [Clock] 2 (hour/minute/second) (Command: f x)

Sets the Clock 2 values (hour/minute/second).

Transmission`(f)(x)()([Set ID])()(Data1)()(Data2)()(Data3)(Cr)`

Data1 00 to 17: Hour 00 to hour 23

Data2 00 to 3B: Minute 00 to minute 59

Data3 00 to 3B: Second 00 to second 59

* Enter "fx [Set ID] ff" to view the Time 2 (hour/minute/second) settings.

* This feature is only available when Clock 1 (year/month/day) has been set.

Acknowledgment`(x)()([Set ID])()(OK/NG)(Data1)(Data2)(Data3)(x)`**18. [No Signal Power Off (15 Min)] (Command: f g)**

Sets the monitor to enter Automatic Standby mode if there is no signal for 15 minutes.

Transmission`(f)(g)()([Set ID])()(Data)(Cr)`

Data 00: [Off]

01: [On]

Acknowledgment`(g)()([Set ID])()(OK/NG)(Data)(x)`**19. [Auto Power Off] (Command: m n)**

Activates Auto Power Off when there is no IR signal for 4 hours.

Transmission`(m)(n)()([Set ID])()(Data)(Cr)`

Data 00: [Off]

01: [On]

Acknowledgment`(n)()([Set ID])()(OK/NG)(Data)(x)`**20. [Language] (Command: f i)**

Sets the OSD language.

Transmission`(f)(i)()([Set ID])()(Data)(Cr)`

Data 00: Czech

01: Danish

02: German

03: English

04: Spanish (Europe)

05: Greek

06: French

07: Italian

08: Dutch

09: Norwegian

0A: Portuguese

0B: Portuguese (Brazil)

0C: Russian

0D: Finnish

0E: Swedish

0F: Korean

10: Chinese (Mandarin)

11: Japanese

12: Chinese (Cantonese)

13: Arabic

Acknowledgment`(i)()([Set ID])()(OK/NG)(Data)(x)`

* Some languages may not be available with certain models.

21. Set [Default] (Command: f k)

Executes Reset.

Initialize Screen can only be executed in RGB input mode.

Transmission

```
(f)(k)( )([Set ID])( )(Data)(Cr)
```

Data 00: Picture Reset
01: Initialize Screen
02: Reset to Initial Settings

Acknowledgment

```
(k)( )([Set ID])( )(OK/NG)(Data)(x)
```

* This feature may not be supported on some models.

22. Current Temperature (Command: d n)

Checks the current temperature of the product.

Transmission

```
(d)(n)( )([Set ID])( )(Data)(Cr)
```

Data FF: Check status

Acknowledgment

```
(n)( )([Set ID])( )(OK/NG)(Data)(x)
```

* The temperature is displayed in hexadecimal.

23. [Key] (Command: m c)

Sends a key code for the IR remote control.

Transmission

```
(m)(c)( )([Set ID])( )(Data)(Cr)
```

Data IR_KEY_CODE

Acknowledgment

```
(c)( )([Set ID])( )(OK/NG)(Data)(x)
```

For key codes, see IR Codes.

* Some key codes may not be supported on some models.

24. Time Elapsed (Command: d l)

Displays the time that has elapsed after your monitor has turned on.

Transmission

```
(d)(l)( )([Set ID])( )(Data)(Cr)
```

Data FF: Reads status

Acknowledgment

```
(l)( )([Set ID])( )(OK/NG)(Data)(x)
```

* The data received is displayed in hexadecimal.

25. Product Serial Number (Command: f y)

Checks the serial number of the product.

Transmission

```
(f)(y)( )([Set ID])( )(Data)(Cr)
```

Data FF: Checks product serial number

Acknowledgment

```
(y)( )([Set ID])( )(OK/NG)(Data)(x)
```

Data is in ASCII format.

26. Software Version (Command: f z)

Checks the software version of the product.

Transmission

```
(f)(z)( )([Set ID])( )(Data)(Cr)
```

Data FF: Checks software version

Acknowledgment

```
(z)( )([Set ID])( )(OK/NG)(Data)(x)
```

27. [White Balance] Red Gain (Command: j m)

Adjusts the red gain value for white balance.

Transmission`(j)(m)()([Set ID])() (Data)(Cr)`Data 00 to FE: Red gain 0 to 254
FF: Checks red gain value**Acknowledgment**`(m)()([Set ID])() (OK/NG)(Data)(x)`**30. [White Balance] Red Offset (Command: s x)**

Adjusts the red offset value for white balance.

Transmission`(s)(x)()([Set ID])() (Data)(Cr)`Data 00 to 7F: Red offset 0 to 127
FF: Checks red offset value**Acknowledgment**`(x)()([Set ID])() (OK/NG)(Data)(x)`**28. [White Balance] Green Gain (Command: j n)**

Adjusts the green gain value for white balance.

Transmission`(j)(n)()([Set ID])() (Data)(Cr)`Data 00 to FE: Green gain 0 to 254
FF: Checks green gain value**Acknowledgment**`(n)()([Set ID])() (OK/NG)(Data)(x)`**31. [White Balance] Green Offset (Command: s y)**

Adjusts the green offset value for white balance.

Transmission`(s)(y)()([Set ID])() (Data)(Cr)`Data 00 to 7F: Green offset 0 to 127
FF: Checks green offset value**Acknowledgment**`(y)()([Set ID])() (OK/NG)(Data)(x)`**29. [White Balance] Blue Gain (Command: j o)**

Adjusts the blue gain value for white balance.

Transmission`(j)(o)()([Set ID])() (Data)(Cr)`Data 00 to FE: Blue gain 0 to 254
FF: Checks blue gain value**Acknowledgment**`(o)()([Set ID])() (OK/NG)(Data)(x)`**32. [White Balance] Blue Offset (Command: s z)**

Adjusts the blue offset value for white balance.

Transmission`(s)(z)()([Set ID])() (Data)(Cr)`Data 00 to 7F: Blue offset 0 to 127
FF: Checks blue offset value**Acknowledgment**`(z)()([Set ID])() (OK/NG)(Data)(x)`

33. [Backlight] (Command: m g)

Adjusts the backlight brightness.

Transmission`(m)(g)()([Set ID])() (Data)(Cr)`

Data 00 to 64: [Backlight] 0 to 100

Acknowledgment`(g)()([Set ID])()(OK/NG)(Data)(x)`**34. [Screen Off] (Command: k d)**

Turns off/off the screen.

Transmission`(k)(d)()([Set ID])() (Data)(Cr)`

Data 00: Screen On

01: Screen Off

Acknowledgment`(d)()([Set ID])()(OK/NG)(Data)(x)`

* This feature may not be supported on some models.

35. [Tile Mode] (Command: d d)

Sets a tile mode and values for the tile rows and columns.

Transmission`(d)(d)()([Set ID])() (Data)(Cr)`Data 00 to FF: the first byte - tile column
The second byte - tile row

* 00, 01, 10, and 11 mean that the tile mode is off

* The maximum value may differ depending on the model.

Acknowledgment`(d)()([Set ID])()(OK/NG)(Data)(x)`

* This feature may not be supported on some models.

* Video wall models require to be rebooted for the normal operation after the values are changed.

36. Check [Tile Mode] (Command: d z)

Checks the tile mode.

Transmission`(d)(z)()([Set ID])() (Data)(Cr)`

Data FF: Checks [Tile Mode]

Acknowledgment`(z)()([Set ID])()(OK/NG)(Data1)(Data2)(Data3)(x)`

Data1 00: [Tile Mode] Off

01: [Tile Mode] on

Data2 00 to 0F: tile column

Data3 00 to 0F: tile row

* This feature may not be supported on some models.

37. [Tile ID] (Command: d i)

Sets the tile ID value of the product.

Transmission`(d)(i)()([Set ID])() (Data)(Cr)`

Data 01 to E1: [Tile ID] 1 to 225

FF: Checks the [Tile ID]

* The data value cannot exceed the value of row x column.

Acknowledgment`(i)()([Set ID])()(OK/NG)(Data)(x)`

* If you enter a value that exceeds the value of row x column for the Data parameter, Ack becomes NG.

* This feature may not be supported on some models.

* Video wall models require to be rebooted for the normal operation after the values are changed.

38. [Natural Mode] (In Tile Mode) (Command: d j)

To display the image naturally, the part of the image that would normally be displayed in the gap between the monitors is omitted.

Transmission`(d)(j)()([Set ID])() (Data)(Cr)`

Data 00: [Off]

01: [On]

Acknowledgment`(j)()([Set ID])()(OK/NG)(Data)(x)`

* This feature may not be supported on some models.

39. [DPM (Standby Mode)] (Command: f j)

Sets the Display Power Management feature.

Transmission**(f)(j)()([Set ID])()(Data)(Cr)**

Data 00: [Off]
 02: 10 seconds
 04: 1 minute
 05: 3 minutes
 06: 5 minutes
 07: 10 minutes

Acknowledgment**(j)()([Set ID])()(OK/NG)(Data)(x)**

* This feature may not be supported on some models.

42. [Fail Over] Select (Command: m i)

Sets an input mode for fail over.

Transmission**(m)(i)()([Set ID])()(Data)(Cr)**

Data 00: [Off]
 01: [Auto]
 02: [Custom]

Acknowledgment**(i)()([Set ID])()(OK/NG)(Data)(x)****43. [Fail Over] Input Select (Command: m j)**

Selects an input source for fail over.

* This feature is only available when Fail Over is set to Custom.

Transmission**(m)(j)()([Set ID])()(Data1)()(Data2)()(Data3)()(Data4) ... ()(DataN)(Cr)**

Data1 to N (input priority 1 to N)
 60: RGB
 70: DVI-D
 90: HDMI1
 91: HDMI2
 92: OPS/HDMI3/DVI-D
 95: OPS/DVI-D
 96: HDMI3/DVI-D
 97: HDMI3/HDMI2/DVI-D
 98: OPS
 C0: DISPLAYPORT

Acknowledgment**(j)()([Set ID])()(OK/NG)(Data1)(Data2)(Data3)(Data4) ... (DataN)(x)**

* Some input signals may not be available with certain models.

* The data number (N) may vary depending on the model. (The data number depends on the number of supported input signals.)

* This feature operates as the last input, and supports data in DTV format.

40. Remote Control/Local Key Lock (Command: k m)

Adjusts the remote control/local key (front) lock.

Transmission**(k)(m)()([Set ID])()(Data)(Cr)**

Data 00: [Off] (Lock Off)
 01: [On] (Lock On)

* When the monitor is turned off, the power key works even in On (01) mode.

Acknowledgment**(m)()([Set ID])()(OK/NG)(Data)(x)**

* This feature may not be supported on some models.

41. [Power On Delay] (Command: f h)

Sets the schedule delay for when the power turns on (unit: seconds).

Transmission**(f)(h)()([Set ID])()(Data)(Cr)**

Data 00 to FA: min. 0 to max. 250 (seconds)

Acknowledgment**(h)()([Set ID])()(OK/NG)(Data)(x)**

* The maximum value may differ depending on the model.

44. Remote Controller Key Lock (Command: t p)

Configures the settings of the product's remote control key.

Transmission**(t)(p)()([Set ID])() (Data)(Cr)**

- Data 00: All keys lock off
 01: Locks on all keys except Power key
 02: Locks on all keys

Acknowledgment**(p)()([Set ID])() (OK/NG)(Data)(x)**

- * When the monitor is turned off, the power key works even in the locks on all of the keys (02) mode.

45. [Local Key Lock] (Command: t o)

Configures the local key operation settings of the product.

Transmission**(t)(o)()([Set ID])() (Data)(Cr)**

- Data 00: All keys lock off
 01: Locks on all keys except Power key
 02: Locks on all keys

Acknowledgment**(o)()([Set ID])() (OK/NG)(Data)(x)**

- * When the monitor is turned off, the power key works even in the locks on all of the keys (02) mode.
 * This feature may not be supported on some models.

46. Check [Status] (Command: s v)

Checks the current signal of the product.

Transmission**(s)(v)()([Set ID])() (Data)() (FF)(Cr)**

- Data 02: Checks whether there is a signal
 03: The monitor is currently in [PM Mode]
 07: Checks whether the Top, Bottom and Main temperature sensors are functioning normally.
 08: The temperature of each temperature sensor when the monitor set was last powered off.
 09: Fan speed
 10: RGB Sensing OK/NG (screen fault detection)

Acknowledgment**(v)()([Set ID])() (OK/NG)(Data)(Data1)(x)**

- Data 02 (when a signal is found)
 Data1 00: No signal
 01: Signal present

 Data 03 (when the monitor is currently in PM mode)
 Data1 00: [Screen On] is activated.
 01: [Screen Off] is activated.
 02: [Screen Off Always] is activated.
 03: [Sustain Aspect Ratio] is activated.
 04: [Screen Off & Backlight] is activated.

 Data 07 (when checking whether the Top, Bottom and Main temperature sensors are working properly)
 Data1 00: All temperature sensors faulty
 01: Top normal, Bottom faulty, Main faulty
 02: Top faulty, Bottom normal, Main faulty
 03: Top normal, Bottom normal, Main faulty
 04: Top faulty, Bottom faulty, Main normal
 05: Top normal, Bottom faulty, Main normal
 06: Top faulty, Bottom normal, Main normal
 07: All temperature sensors are normal

 Data 10 (when executing [Screen Fault Detection])
 Data1 00: [Screen Fault Detection] result NG
 07: [Screen Fault Detection] result OK

- * When screen Fault Detection is set to Off or not supported, execution results are rendered "NG."

Data 08 (when checking the temperature of each temperature sensor when the monitor set was last powered off)

Acknowledgment

(v)()([Set ID])()(OK/NG)(Data)(Data1)
(Data2)(Data3)(x)

Data1 The temperature of the Top sensor when the monitor set was last powered off.

Data2 The temperature of the Bottom sensor when the monitor set was last powered off.

Data3 The temperature of the Main sensor when the monitor set was last powered off.

Data 09 (when checking the fan speed)

Acknowledgment

(v)()([Set ID])()(OK/NG)(Data)(Data1)(Data2)(x)

Data1 00-ff: The upper 1-byte of the fan speed

Data2 00-ff: The lower 1-byte of the fan speed

Fan speed: 0 to 2008 in hexadecimal and 0 to 8200 in decimal

* This feature may not be supported on some models.

47. [Screen Fault Detection] (Command: t z)

Sets the Screen Fault Detection feature.

Transmission

(t)(z)()([Set ID])()(Data)(Cr)

Data 00: [Off]

01: [On]

Acknowledgment

(z)()([Set ID])()(OK/NG)(Data)(x)

* This feature may not be supported on some models.

48. [Daylight Saving Time] (Command: s d)

Sets Daylight Savings Time.

Transmission

(s)(d)()([Set ID])()(Data1)()(Data2)()
(Data3)() (Data4)() (Data5)()(Cr)

Data1 00: [Off] (Data2-5: FF)

01: Start time

02: End time

Data2 01-0C: January to December

Data3 01 to 06: Weeks 1 to 6

* The maximum value of [Data3] may vary depending on the date.

Data4 00 to 06 (Sunday to Saturday)

Data5 00 to 17: Hour 00 to hour 23

* If you wish to read the start/end times, enter FF for parameters [Data2] through [Data5].

(E.g. 1: sd 01 01 ff ff ff ff - Checks the end time.)

(E.g. 2: sd 01 02 ff ff ff ff - Checks the start time.)

* This feature only works when Clock 1 (year/month/day) and Clock 2 (hour/minute/second) have been set.

Acknowledgment

(d)()([Set ID])()(OK/NG)(Data1)(Data2)
(Data3)(Data4)(Data5)(x)

* This feature may not be supported on some models.

49. [PM Mode] (Command: s n, 0c)

Sets the PM mode.

Transmission

(s)(n)()([Set ID])()(0c)()(Data)(Cr)

Data 00: Activates Power Off mode

01: Activates [Sustain Aspect Ratio] mode

02: Activates [Screen Off] mode

03: Activates [Screen Off Always] mode

04: Activates [Screen Off & Backlight] mode

Acknowledgment

(n)()([Set ID])()(OK/NG)(0c)(Data)(x)

* This feature may not be supported on some models.

50. [ISM Method] (Command: j p)

Selects an ISM method.

Transmission

(j)(p)()([Set ID])()(Data)(Cr)

Data	01: [Inversion] (Invert)
	02: [Orbiter] (Move)
	04: [White Wash] (Remove; white pattern)
	08: [Normal] (Standard)
	20: [Color Wash] (Color pattern)
	80: [Washing Bar]
	90: [User Image]
	91: [User Video]

* The jp command only works when the timer has been set to immediately.

Acknowledgment

(p)()([Set ID])()(OK/NG)(Data)(x)

* This feature may not be supported on some models.

51. [Network Settings] (Command: s n, 80 or 81 or 82)

Configures network and DNS settings.

Transmission

(s)(n)()([Set ID])()(Data1)()(Data2)()
(Data3)()(Data4)()(Data5)(Cr)

Data1 80: Configures/views the temporary IP mode (Auto/Manual), subnet mask, and gateway.
81: Configures/views the temporary DNS address.
82: Saves temporary settings and views information about the current network.

* If Data 1 is 80,

Data2 00: Auto
01: Manual
FF: Views the temporary IP mode (Auto/Manual), subnet mask, and gateway.

* If Data 2 is 01 (Manual),

Data3 Manual IP address
Data4 Subnet mask address
Data5 Gateway address

* If Data 1 is 81,

Data2 DNS address
FF: Displays the temporary DNS address.

* If Data 1 is 82,

Data2 80: Applies the temporarily saved IP mode (Auto/Manual), subnet mask and gateway.
81: Applies the temporary DNS address
FF: Information on the current network (IP, subnet gateway and DNS)

* An example of settings,

1. Auto: sn 01 80 00
 2. Manual: sn 01 80 01 010177223241 255255254000 010177222001 (IP: 10.177.223.241, subnet: 255.255.254.0, gateway: 10.177.222.1)
 3. Network read: sn 01 80 ff
 4. DNS settings: sn 01 81 156147035018 (DNS: 156.147.35.18)
 5. Applying the settings: sn 01 82 80 (applies the saved IP mode (auto/manual), subnet mask, and gateway), sn 01 82 81 (applies the saved DNS)
- * Each IP address contains 12 decimal digits.

Acknowledgment

(n)()([Set ID])()(OK/NG)(Data1)(Data)(x)

* This feature is available only for wired networks.

* This feature may not be supported on some models.

52. [Auto Configuration] (Command: j u)

Automatically corrects the position and shaking of the picture.
(Works only in RGB-PC input mode.)

Transmission

(j)(u)()([Set ID])()(Data)(Cr)

Data 01: Execution

Acknowledgment

(u)()([Set ID])()(OK/NG)(Data)(x)

* This feature may not be supported on some models.

53. [H Position] (Command: f q)

Adjusts the horizontal position of the screen.

* The operational range varies depending on the RGB input resolution.

(Works only in RGB-PC input mode.)

Transmission

(f)(q)()([Set ID])()(Data)(Cr)

Data 00-64: Min -50 (Left) to Max 50 (Right)

Acknowledgment

(q)()([Set ID])()(OK/NG)(Data)(x)

* This feature may not be supported on some models.

54. [V Position] (Command: f r)

Adjusts the vertical position of the screen.

* The operational range varies depending on the RGB input resolution.

(Works only in RGB-PC input mode.)

Transmission

(f)(r)()([Set ID])()(Data)(Cr)

Data 00-64: Min -50 (Down) to Max 50 (Up)

Acknowledgment

(r)()([Set ID])()(OK/NG)(Data)(x)

* This feature may not be supported on some models.

55. [H Size] (Command: f s)

Adjusts the horizontal size of the screen.

* The operational range varies depending on the RGB input resolution.

(Works only in RGB-PC input mode.)

Transmission

(f)(s)()([Set ID])()(Data)(Cr)

Data 00-64: Min -50 (Small) to Max 50 (Large)

Acknowledgment

(s)()([Set ID])()(OK/NG)(Data)(x)

* This feature may not be supported on some models.

56. [Power On Status] (Command: t r)

Sets the Power On status of the monitor.

Transmission

(t)(r)()([Set ID])()(Data)(Cr)

Data 00: LST (Maintains the previous power status)

01: STD (Keeps the power off)

02: PWR (Keeps the power on)

Acknowledgment

(r)()([Set ID])()(OK/NG)(Data)(x)

57. Wired [Wake On LAN (Networked standby mode)] (Command: f w)

Selects a Wired Wake On LAN option.

Transmission

(f)(w)()([Set ID])()(Data)(Cr)

Data 00: [Off]

01: [On]

Acknowledgment

(w)()([Set ID])()(OK/NG)(Data)(x)

58. [Intelligent Auto] (Command: t i)

Selects an Intelligent Auto option.

Transmission

(t)(i)()([Set ID])()(Data)(Cr)

Data 00: [Off]
01: [On]

Acknowledgment

(i)()([Set ID])()(OK/NG)(Data)(x)

* This feature may not be supported on some models.

59. [OSD Rotation] (Command: t h)

Sets the OSD Rotation mode.

Transmission

(t)(h)()([Set ID])()(Data)(Cr)

Data 00: [Off]
01: 90 degrees
02: 270 degrees
03: 180 degrees

Acknowledgment

(h)()([Set ID])()(OK/NG)(Data)(x)

* This feature may not be available on some models.

60. [Time Sync] (Command: s n, 16)

Sets Time Sync.

Transmission

(s)(n)()([Set ID])()(1)(6)()(Data)(Cr)

Data 00: [Off]
01: [On]

* This feature only works when the monitor is in Master mode.

* This feature does not work if the current time is not set.

Acknowledgment

(n)()([Set ID])()(OK/NG)(1)(6)(Data)(x)

* This feature may not be supported on some models.

61. [Content Sync] (Command: t g)

Sets Content Sync.

Transmission

(t)(g)()([Set ID])()(Data)(Cr)

Data 00: [Off]
01: [On]

Acknowledgment

(g)()([Set ID])()(OK/NG)(Data)(x)

* This feature may not be supported on some models.

62. [LAN Daisy Chain] (Command: s n, 84)

Turns on/off LAN Daisy Chain.

Transmission

(s)(n)()([Set ID])()(8)(4)()(Data)(Cr)

Data 00: [Off]
01: [On]

Acknowledgment

(n)()([Set ID])()(OK/NG)(8)(4)(Data)(x)

* This feature may not be supported on some models.

63. [Content Rotation] (Command: s n, 85)

Turns on/off Content Rotation.

Transmission

(s)(n)()([Set ID])()(8)(5)()(Data)(Cr)

Data 00: [Off]
01: 90 degrees
02: 270 degrees
03: 180 degrees

Acknowledgment

(n)()([Set ID])()(OK/NG)(8)(5)(Data)(x)

* This feature may not be supported on some models.

64. [Scan Inversion] (Command: s n, 87)

Turns on/off Scan Inversion.

Transmission`(s)(n)()([Set ID])() (8)(7)() (Data)(Cr)`

Data 00: [Off]

01: [On]

Acknowledgment`(n)()([Set ID])() (OK/NG)(8)(7)(Data)(x)`

- * This feature may not be supported on some models.
- * Video wall models require to be rebooted for the normal operation after the values are changed.

65. [Beacon] (Command: s n, 88)

Turns on/off Beacon.

Transmission`(s)(n)()([Set ID])() (8)(8)() (Data)(Cr)`

Data 00: [Off]

01: [On]

Acknowledgment`(n)()([Set ID])() (OK/NG)(8)(8)(Data)(x)`

- * This feature may not be supported on some models.

66. [Brightness Scheduling] Mode (Command: s m)

Selects a Brightness Scheduling mode.

Transmission`(s)(m)()([Set ID])() (Data)(Cr)`

Data 00: Brightness Scheduling off

01: Brightness Scheduling on

- * This feature does not work if the current time is not set.
- * This feature may not be supported on some models.

Acknowledgment`(m)()([Set ID])() (OK/NG)(Data)(x)`**67. [Brightness Scheduling] (Command: s s)**

Sets Brightness Scheduling.

Transmission`(s)(s)()([Set ID])() (Data1)() (Data2)() (Data3)(Cr)`

Data1

1. f1 to f6 (data reading)

F1: Reads the 1st brightness schedule's data

F2: Reads the 2nd brightness schedule's data.

F3: Reads the 3rd brightness schedule's data.

F4: Reads the 4th brightness schedule's data.

F5: Reads the 5th brightness schedule's data.

F6: Reads the 6th brightness schedule's data.

FF: Reads all stored lists

3. e1 to e6 (Deletes one index), e0 (Deletes all indexes)

E0: Deletes all brightness schedules.

E1: Deletes the 1st brightness schedule.

E2: Deletes the 2nd brightness schedule.

E3: Deletes the 3rd brightness schedule.

E4: Deletes the 4th brightness schedule.

E5: Deletes the 5th brightness schedule.

E6: Deletes the 6th brightness schedule.

4. 00 to 17: Hour 00 to hour 23

Data2 00 to 3B: Minute 00 to minute 59th

Data2 00 to 64: Backlights 0 to 100

- * To read or delete a brightness schedule you have set, [Data2] [Data3] must be set to FF.
- * If you want to read all configured brightness schedules through FF, do not enter any values in [[Data2][Data3].
- * When all configured brightness schedules are read through FF, OK is acknowledged even if there is no stored list.

Example 1: fd 01 f1 ff ff - Reads the 1st index data in Brightness Scheduling.

Example 2: sn 01 1b ff ff ff ff - Reads all index data in in Brightness Scheduling.

Example 3: fd 01 e1 ff ff - Deletes the 1st index data in Brightness Scheduling.

Example 4: ss 01 07 1E 46 - Adds a schedule whose time is 07:30 and whose backlight is 70.

- * This feature may not be supported on some models.

Acknowledgment`(s)()([Set ID])() (OK/NG)(Data1)(Data2)(Data3)(x)`

68. [Multi Screen] Mode & Input (Command: x c)

Saves and controls Multi Screen modes and inputs.

Transmission`(x)(c)()([Set ID])()(Data1)()(Data2)()(Data3)()(Data4)()(Data5)()(Cr)`

Data1 (Sets MultiScreen mode)

- 10: PIP
- 22: PBP2
- 23: PBP3
- 24: PBP4

Data2 (Sets the MultiScreen Main Input)

Data3 (sets the MultiScreen Sub1 Input)

Data4 (sets the MultiScreen Sub2 Input)

Data5 (sets the MultiScreen Sub3 Input)

- 80: DVI-D
- 90: HDMI1
- 91: HDMI2/OPS
- 92: OPS/HDMI3/DVI-D
- 95: OPS/DVI-D
- 96: HDMI3/DVI-D
- 97: HDMI3/HDMI2/DVI-D
- 98: OPS
- CO: DISPLAYPORT

Acknowledgment`(c)()([Set ID])()(OK/NG)()(Data1)(Data2)(Data3)(Data4)(Data5)(x)`

- * This feature may not be supported on some models.
- * Only the input modes supported by the model works.
- * This feature operates as the last input, and supports data in DTV format.
- * Please add the following statement: "When the Read operation is performed, 00 is returned if it is not an external input."

69. [Aspect Ratio] (Multi Screen) (Command: x d)

Saves and controls aspect ratios (Multi Screen).

Transmission`(x)(d)()([Set ID])()(Data1)()(Data2)(Cr)`

Data1 Controls the Main input

- 02: Controls the Sub1 input
- 03: Controls the Sub2 input
- 04: Controls the Sub3 input

Data2 00: [Full]
01: [Original]

Acknowledgment`(d)()([Set ID])()(OK/NG)(Data1)(Data2)(x)`

- * This feature may not be supported on some models.

70. [Screen Off] (Multi Screen) (Command: x e)

Turns on/off each screen in the Multi Screen.

Transmission`(x)(e)()([Set ID])()(Data1)()(Data2)(Cr)`

Data1 Controls the Main input

- 02: Controls the Sub1 input
- 03: Controls the Sub2 input
- 04: Controls the Sub3 input

Data2 00: Screen off
01: Turns the screen off.

- * This feature only works when the Multi Screen app is running.
- * This feature does not work when there is no signal.

Acknowledgment`(e)()([Set ID])()(OK/NG)(Data1)(Data2)(x)`

- * This feature may not be supported on some models.

71. [Screen Off Always] (Command: s n, 0d)

If you activate the Screen Off Always feature, the monitor enters Screen Off mode regardless of whether or not you have activated PM mode.

Transmission`(s)(n)()([Set ID])()(0)(d)()(Data)(Cr)`

Data 00: [Off]
01: [On]

Acknowledgment`(n)()([Set ID])()(OK/NG)(0)(d)(Data)(x)`

- * This feature may not be supported on some models.

72. Screen Video Freeze (Command: k x)

Controls pauses of the video.

Transmission`(k)(x)()([Set ID])()(Data)(Cr)`

Data 00: Turns on the freeze function.
01: Turns off the Freeze feature.

- * This feature only works in single input mode.

Acknowledgment`(x)()([Set ID])()(OK/NG)(Data)(x)`

- * This feature may not be supported on some models.

73. Wireless [Wake On LAN (Networked standby mode)] (Command: s n, 90)

Sets the Wireless Wake-on-LAN feature.

Transmission`(s)(n)()([Set ID])() (9)(0)() (Data)(Cr)`Data 00: [Off]
01: [On]**Acknowledgment**`(n)()([Set ID])() (OK/NG)(9)(0)(Data)(x)`

* This feature may not be supported on some models.

74. OSD Lock (Command: k l)

Sets OSD Lock.

Transmission`(k)(l)()([Set ID])() (Data)(Cr)`Data 00: OSD Lock
01: Unlock OSD Lock**Acknowledgment**`(l)()([Set ID])() (OK/NG)(Data)(x)`**75. [HDMI IT Contents] (Command: s n, 99)**

Automatically sets the picture mode based on HDMI data.

Transmission`(s)(n)()([Set ID])() (9)(9)() (Data)(Cr)`Data 00: [Off]
01: [On]**Acknowledgment**`(n)()([Set ID])() (OK/NG)(9)(9)(Data)(x)`

* This feature may not be supported on some models.

76. [On/Off Time Scheduling] (Command: s n, 9a)

Sets on/off time schedules.

Transmission

- `(s)(n)()([Set ID])() (9)(a)() (Data1)() (Data2)() (Data3)() (Data4)() (Data5)(Cr)`
- `(s)(n)()([Set ID])() (9)(a)() (Data1)() (Data2)(Cr)`
- `(s)(n)()([Set ID])() (9)(a)() (Data1)(Cr)`

1. Setting an On/Off Time

Data1 Select the desired day of the week

01: Sunday
02: Monday
03: Tuesday
04: Wednesday
05: Thursday
06: Friday
07: Saturday

Data2 Set an On Time (hour)

00 to 17: Hour 00 to hour 23

Data3 Set an On Time (minute)

00 to 3B: Minute 00 to minute 59

Data4 Set an Off Time (hour)

00 to 17: Hour 00 to hour 23

Data5 Set an Off Time (minute)

00 to 3B: Minute 00 to minute 59

2. Checking a Schedule

Data1 Select the desired schedule.

F1: Reads the schedule for Sunday
F2: Reads the schedule for Monday
F3: Reads the schedule for Tuesday
F4: Reads the schedule for Wednesday
F5: Reads the schedule for Thursday
F6: Reads the schedule for Friday
F7: Reads the schedule for Saturday

Data2

FF

3. Deleting a Schedule

E0: Deletes all schedules
E1: Deletes the schedule for Sunday
E2: Deletes the schedule for Monday
E3: Deletes the schedule for Tuesday
E4: Deletes the schedule for Wednesday
E5: Deletes the schedule for Thursday
E6: Deletes the schedule for Friday
E7: Deletes the schedule for Saturday

* This feature does not work if the current time is not set.

Acknowledgment

- `(n)()([Set ID])() (OK/NG)(9)(a) (Data1)(Data2)(Data3)(Data4)(Data5)(x)`
- `(n)()([Set ID])() (OK/NG)(9)(a)(f)(1-7) (Data1)(Data2)(Data3)(Data4)(Data5)(x)`
- `(n)()([Set ID])() (OK/NG)(9)(a)(Data1)(x)`

* This feature may not be supported on some models.

77. [Holiday Setting] (Command: s n, 9b)

Sets holidays.

Transmission

1. (s)(n)()([Set ID])()(9)(b)()
(Data1)()(Data2)()(Data3)()
(Data4)()(Data5)()(Data6)(Cr)
2. (s)(n)()([Set ID])()(9)(b)()(Data1)()(Data2)(Cr)
3. (s)(n)()([Set ID])()(9)(b)()(Data1)(Cr)

1. Setting a Holiday

- Data1 Start year
00-: 2010-
- Data2 Start month
01 to 0c: January to December
- Data3 Start date
01 to 1F: 1st to 31st
- Data4 For how long from the start year/month/date
01-07: For 1 to 7 days
- Data5 Repetition
00: None
01: Every month
02: Every Year
- Data6 Repeats the schedule on a date/day-of-the-week basis.
01: On a date basis.
02: On a day-of-the-week basis.

- * The minimum and maximum values for [Data1] differ depending on the product's release year.
- * You can input a value for [Data 6] only when a value has already been set for [Data 5] (every year or every month).

2. Checking a Schedule

- Data1 Select the desired schedule.
F1: Reads the 1st schedule
F2: Reads the 2nd schedule
F3: Reads the 3rd schedule
F4: Reads the 4th schedule
F5: Reads the 5th schedule
F6: Reads the 6th schedule
F7: Reads the 7th schedule

Data2

FF

3. Deleting a Schedule

- E0: Deletes all schedules
E1: Deletes the 1st schedule
E2: Deletes the 2nd schedule
E3: Deletes the 3rd schedule
E4: Deletes the 4th schedule
E5: Deletes the 5th schedule
E6: Deletes the 6th schedule
E7: Deletes the 7th schedule

- * This feature does not work if the current time is not set.

Acknowledgment

1. (n)()([Set ID])()(OK/NG)(9)(b)
(Data1)(Data2)(Data3)(Data4)(Data5)(Data6)(x)
2. (n)()([Set ID])()(OK/NG)(9)(b)(f)(1-7)
(Data1)(Data2)(Data3)(Data4)(Data5)(Data6)(x)
3. (n)()([Set ID])()(OK/NG)(9)(b)(Data1)(x)

- * This feature may not be supported on some models.

78. [UPnP] Mode (Command: s n, 9c)

Sets UPnP mode.

Transmission

- (s)(n)()([Set ID])()(9)(c)()(Data)(Cr)
- Data 00: [Off]
01: [On]

Acknowledgment

- (n)()([Set ID])()(OK/NG)(9)(c)(Data)(x)

- * This feature may not be supported on some models.
- * Changing UPnP mode results in a reboot.

79. [Home Dashboard Lock] (Command: s n, 9d)

Sets Home Dashboard Lock.

Transmission`(s)(n)()([Set ID])() (9)(d)() (Data)(Cr)`

Data 00: [Off]

01: [On]

Acknowledgment`(n)()([Set ID])() (OK/NG)(9)(d)(Data)(x)`

* This feature may not be supported on some models.

82. [Screen Share Lock] (Command: s n, a0)

Sets Screen Share Lock.

Transmission`(s)(n)()([Set ID])() (a)(0)() (Data)(Cr)`

Data 00: [Off]

01: [On]

Acknowledgment`(n)()([Set ID])() (OK/NG)(a)(0)(Data)(x)`

* This feature may not be supported on some models.

80. [USB Lock] (Command: s n, 9e)

Sets USB Lock.

Transmission`(s)(n)()([Set ID])() (9)(e)() (Data)(Cr)`

Data 00: [Off]

01: [On]

Acknowledgment`(n)()([Set ID])() (OK/NG)(9)(e)(Data)(x)`

* This feature may not be supported on some models.

83. [Backup via Storage] (Command: s n, a1)

Sets Backup via Storage.

Transmission`1. (s)(n)()([Set ID])() (a)(1)() (Data1)(Cr)``2. (s)(n)()([Set ID])() (a)(1)() (Data1)(Data2)(Cr)`

1. Disabling Backup via Storage.

Data1 00: [Off]

2. Setting Backup via Storage to Auto

Data1 01: [Auto]

Data2 01: [30 Min]

02: [1 Hour]

03: [2 Hours]

04: [3 Hours]

3. Setting Backup via Storage to Manual

Data1 02: Manual

4. Setting Backup via Storage to SuperSign Content

Data1 03: SuperSign content

Acknowledgment`1. (n)()([Set ID])() (OK/NG)(a)(1)(Data1)(x)``2. (n)()([Set ID])() (OK/NG)(a)(1)(Data1)(Data2)(x)`

* This feature may not be supported on some models.

81. [Wi-Fi Lock] (Command: s n, 9f)

Sets Wi-Fi Lock.

Transmission`(s)(n)()([Set ID])() (9)(f)() (Data)(Cr)`

Data 00: [Off]

01: [On]

Acknowledgment`(n)()([Set ID])() (OK/NG)(9)(f)(Data)(x)`

* This feature may not be supported on some models.

84. [Digital Audio Input] (Command: s n, a2)

Sets Digital Audio Input.

Transmission`(s)(n)()([Set ID])()(a)(2)()(Data)(Cr)`

Data 00: [Digital]

01: [Analog]

Acknowledgment`(n)()([Set ID])()(OK/NG)(a)(2)(Data)(x)`

* This feature may not be supported on some models.

85. [Booting Logo Image] (Command: s n, a3)

Sets Booting Logo Image.

Transmission`(s)(n)()([Set ID])()(a)(3)()(Data)(Cr)`

Data 00: [Off]

01: [On]

Acknowledgment`(n)()([Set ID])()(OK/NG)(a)(3)(Data)(x)`

* This feature may not be supported on some models.

86. [SoftAP] Mode (Command: s n, a4)

Sets SoftAP Mode.

Transmission`(s)(n)()([Set ID])()(a)(4)()(Data)(Cr)`

Data 00: [Off]

01: [On]

Acknowledgment`(n)()([Set ID])()(OK/NG)(a)(4)(Data)(x)`

* This feature may not be supported on some models.

87. [Natural Size] (Command: s n, a5)

Sets Natural Size.

Transmission`(s)(n)()([Set ID])()(a)(5)()(Data)(Cr)`

Data 00-64: [Natural Size] 0-100

Acknowledgment`(n)()([Set ID])()(OK/NG)(a)(5)(Data)(x)`

* This feature may not be supported on some models.

88. [Clear Panel Noise] (Command: s n, a6)

Immediately executes Clear Panel Noise.

Transmission`(s)(n)()([Set ID])()(a)(6)()(Data)(Cr)`

Data 01: Execution

Acknowledgment`(n)()([Set ID])()(OK/NG)(a)(6)(Data)(x)`

* This feature may not be supported on some models.

89. [Change PIN Code] (Command: s n, a7)

Changes PIN Code.

Transmission`(s)(n)()([Set ID])()(a)(7)()(Data1)(Data2)(Data3)``(Data4)()(Data5)(Data6)(Data7)(Data8)(Cr)`

Data 1-4: 0-9 (Existing PIN code)

Data 5-8: 0-9 (New PIN code)

Acknowledgment`(n)()([Set ID])()(OK/NG)(a)(7)()(Data1)(Data2)``(Data3)(Data4)()(Data5)(Data6)(Data7)(Data8)(x)`

* This feature may not be supported on some models.

90. Play Internal Storage Media (Command: s n, a8)

Plays the media stored on the monitor's internal storage.

Internal storage media: videos and images stored on the monitor's internal storage after being exported via Contents Management Player.

Not applicable: Template content, SuperSign content, and playlist content.

Transmission

(s)(n)()([Set ID])() (a)(8)() (Data)(Cr)

Data 01: [Play]

Acknowledgment

(n)()([Set ID])()(OK/NG)(a)(8)() (Data)(x)

* This feature may not be supported on some models.

91. [No Signal Image] (Command: s n, a9)

Turns on/off No Signal Image.

Transmission

(s)(n)()([Set ID])() (a)(9)() (Data)(Cr)

Data 00: [Off]

01: [On]

Acknowledgment

(n)()([Set ID])()(OK/NG)(a)(9)(Data)(x)

* This feature may not be supported on some models.

92. [Audio Out] (Command: s n, aa)

Controls the status of Audio Out (Volume Mute, Variable, Fixed, or Off).

Transmission

(s)(n)()([Set ID])() (a)(a)() (Data)(Cr)

Data 00: [Off]

01: [Variable]

02: [Fixed]

Acknowledgment

(n)()([Set ID])()(OK/NG)(a)(a)(Data)(x)

* This feature may not be supported on some models.

93. [DPM (Standby Mode) Wake Up Control] (Command: s n, Ob)

Selects a DPM Wake Up option.

Transmission

(s)(n)()([Set ID])()(0)(b)() (Data)(Cr)

Data 00: [Clock]

01: [Clock+DATA]

Acknowledgment

(n)()([Set ID])()(OK/NG)(0)(b)(Data)(x)

* This feature may not be supported in some models.

94. Fan Failure Check (Command: d w)

Check the fan malfunction.

Transmission

(d)(w)()([Set ID])() (Data)(Cr)

Data FF: Read status

Acknowledgment

(w)()([Set ID])()(OK/NG)(Data1)(Data2)(x)

Data1 00: Fan failure

01: Fan normal

Data2 00: 0 faults (Fan Normal)

01: 1 fault

02: 2 faults

03: 3 faults

04: 4 faults

05: 5 faults

06: 6 faults

07: 7 faults

08: 8 faults

09: 9 faults

0A: 10 are faulty.

* This feature may not be available on some models.

95. [Apply to all inputs] (Command: s n, 52)

Apply the video mode and low value of the current input to the same video value of all inputs.

Transmission

(s)(n)()([Set ID])()(5)(2)()(Data)(Cr)

Data 01: [Apply]

Acknowledgment

(n)()([Set ID])()(OK/NG)(5)(2)(Data)(x)

- * This feature may not be available on some models.
- * Other commands do not work for a certain time after applying.

96. [Frame Control] (Command: s n, b7)

Controls Frame Control.

Transmission

(s)(n)()([Set ID])()(b)(7)()(Data)(Cr)

Data 00: Off
01: On

Acknowledgment

(n)()([Set ID])()(OK/NG)(b)(7)(Data)(x)

- * This feature may not be available for all models.
- * Video wall models require to be rebooted for the normal operation after the values are changed.

97. Multichannel (Command: s n, 76)

Switches channels.

Transmission

(s)(n)()([Set ID])()(7)(6)()(Data)(Cr)

Data 01 - 09: Channel to switch to

Acknowledgment

(n)()([Set ID])()(OK/NG)(7)(6)(Data)(x)

- * This feature may not be available for all models.

