



OWNER'S MANUAL

WASHING MACHINE



Before beginning installation, read these instructions carefully. This will simplify installation and ensure that the product is installed correctly and safely. Leave these instructions near the product after installation for future reference.

ENGLISH

P9000R



MFL72042043
Rev.00_122123

www.lg.com

Copyright © 2023 LG Electronics Inc. All Rights Reserved.

TABLE OF CONTENTS

This manual may contain images or content that may be different from the model you purchased.
This manual is subject to revision by the manufacturer.

SAFETY INSTRUCTIONS

READ ALL INSTRUCTIONS BEFORE USE.....3
WARNING.....3

INSTALLATION

Parts and Specifications8
Installation Place Requirements9
Installing the Drain Hose10

OPERATION

Preparing the Wash Load12
Adding Detergents.....12
Control Panel13
Operating the Appliance14

MAINTENANCE

Cleaning after Every Wash17
Cleaning the Appliance Periodically17
Caring the Appliance18

TROUBLESHOOTING

Before Calling for Service.....20

APPENDIX

Reference21

SAFETY INSTRUCTIONS

READ ALL INSTRUCTIONS BEFORE USE

The following safety guidelines are intended to prevent unforeseen risks or damage from unsafe or incorrect operation of the appliance. The guidelines are separated into 'WARNING' and 'CAUTION' as described below.

Safety Messages

 This symbol is displayed to indicate matters and operations that can cause risk. Read the part with this symbol carefully and follow the instructions in order to avoid risk.

 **WARNING**
This indicates that the failure to follow the instructions can cause serious injury or death.

 **CAUTION**
This indicates that the failure to follow the instructions can cause minor injury or damage to the product.

WARNING

WARNING

- To reduce the risk of explosion, fire, death, electric shock, injury or scalding to persons when using this product, follow basic precautions, including the following:

Technical Safety

- This appliance is not intended for use by persons (including children) with reduced physical, sensory or mental capabilities, or lack of experience and knowledge, unless they have been given supervision or instruction concerning use of the appliance by a person responsible for their safety.

- Children should be supervised to ensure that they do not play with the appliance.
- Cleaning and user maintenance shall not be made by children without supervision.
- If the power cord is damaged, it must be replaced by the manufacturer, its service agent or similarly qualified persons in order to avoid a hazard.
- Ventilation openings must not be obstructed by a carpet.
- This appliance is intended to be used in household only.
- Use a new hose or hose-set supplied with the appliance. Reusing old hoses can cause a water leak and subsequent property damage.
- The inlet water pressure must be less than 100 kPa.

Maximum Capacity

The maximum capacity for clothes to be used is **Wash (9 kg) / Spin (6.5 kg)**.

NOTE

- Maximum wash capacity is based on dry clothes and maximum spin capacity is based on wet clothes.
-

Installation

- Never attempt to operate the appliance if it is damaged, malfunctioning, partially disassembled, or has missing or broken parts, including a damaged cord or plug.
- This appliance should only be transported by two or more people holding the appliance securely.
- Do not install the appliance in a damp and dusty place. Do not install or store the appliance in any outdoor area, or any area that is subject to weathering conditions such as direct sunlight, wind, rain, or temperatures below freezing.
- Make sure the power plug is completely pushed into the power outlet.

- Do not plug the appliance into multiple outlet sockets or an extension power cable.
- Do not modify the power plug provided with the appliance. If it does not fit the power outlet, have a proper outlet installed by a qualified electrician.
- This appliance must be grounded. In the event of malfunction or breakdown, grounding will reduce the risk of electric shock by providing a path of least resistance for electric current.
- This appliance is equipped with a power cord having an equipment-grounding conductor and a grounding power plug. The power plug must be plugged into an appropriate outlet socket that is installed and grounded in accordance with all local codes and ordinances.
- Improper connection of the equipment-grounding conductor can result in risk of electric shock. Check with a qualified electrician or service personnel if you are in doubt as to whether the appliance is properly grounded.
- Tighten and secure the drain hose at connecting ends to avoid separation.

Operation

- Do not attempt to separate any panels or disassemble the appliance.
- Do not repair or replace any part of the appliance. All repairs and servicing must be performed by qualified service personnel unless specifically recommended in this Owner's Manual. Use only authorized factory parts.
- Do not leave the appliance door open. Children may hang on the door or crawl inside the appliance, causing damage or injury.
- Do not put in, wash or dry articles that have been cleaned in, washed in, soaked in, or spotted with combustible or explosive substances (such as waxes, wax removers, oil, paint, gasoline, degreasers, drycleaning solvents, kerosene, petrol, spot removers, turpentine, vegetable oil, cooking oil, acetone, alcohol, etc.). Improper use can cause fire or explosion.

- Do not use or store flammable or combustible substances (ether, benzene, alcohol, chemical, LPG, combustible spray, insecticide, air freshener, cosmetics, etc.) near the appliance.
- Do not place flammable objects (such as candles, lamps, etc.) or heating devices (such as stoves, heaters, etc.) on the appliance.
- Never reach into the appliance while it is operating. Wait until the drum has completely stopped.
- In case of a water leak from the appliance, disconnect the power plug and contact the LG Electronics customer information centre.
- Turn off water taps to relieve pressure on hoses and valves and to minimize leakage if a break or rupture should occur. Check the condition of the fill hoses; they may need replacement after 5 years.
- If there is a gas leakage (isobutane, propane, natural gas, etc.) within the home, do not touch the appliance or power plug and ventilate the area immediately.
- If the drain hose or inlet hose is frozen during winter, use it only after thawing.
- Keep all washing detergents, softener and bleach away from children.
- Do not touch the power plug or the appliance controls with wet hands.
- Do not bend the power cable excessively or place a heavy object on it.
- Wipe off dirt or dust on the contacts of the power plug.
- Do not fill the washing machine with more than 50 °C water. It may deform plastic parts or cause malfunctions.
- Do not drain water from the wash tub while the spin tub is operating.
- Always unplug the power cord after use.
- During washing spinning and drain, check that drain hose is lowered.

Maintenance

- Disconnect the appliance from the power supply before cleaning the appliance. Setting the controls to the OFF or stand by position does not disconnect this appliance from the power supply.

- Securely plug the power plug in the outlet socket after completely removing any moisture and dust.
- Do not spray water inside or outside the appliance to clean it.
- Never unplug the appliance by pulling on the power cable. Always grip the power plug firmly and pull straight out from the outlet socket.
- Only qualified service personnel from LG Electronics service centre should disassemble, repair, or modify the appliance. Contact an LG Electronics customer information centre if you move and install the appliance in a different location.

Disposal

- Before discarding an old appliance, unplug it. Cut off the cable directly behind the appliance to prevent misuse.
- Dispose of all packaging materials (such as plastic bags and styrofoam) away from children. The packaging materials can cause suffocation.

INSTALLATION

Parts and Specifications

NOTE

- Appearance and specifications may change without notice to improve the quality of the appliance.

Front View

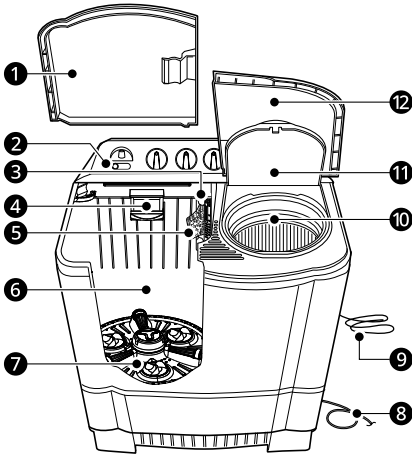

- ① Washing Cover
- ② Water Supply Selector
- ③ Over Flow Filter
- ④ Detergent Box
- ⑤ Rotation Filter-C*1
- ⑥ Cabinet
- ⑦ Pulsator
- ⑧ Power Cord
- ⑨ Earth Wire *2
- ⑩ Spin Dryer Basket
- ⑪ Safety Cover
- ⑫ Spin Dryer Cover

*2 This feature is only available on models with a two-pin plug.

Accessories

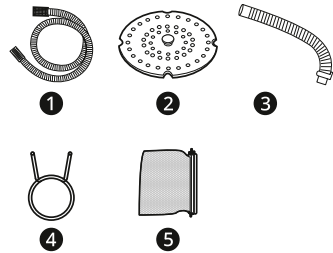

- ① Inlet Hose
- ② Safety Cover
- ③ Drain Hose
- ④ Snap Ring
- ⑤ Rotation Filter-C*1

*1 The included accessories vary depending on the model you purchased.

*1 This feature is only available on some models.

Specifications

Model	P9000R
Water Level	H : 60 litres
Water Pressure	Less than 100 kPa (1 kgf/cm ²)
Product Weight	25 kg

Dimension(mm)

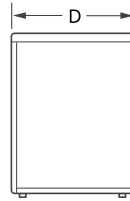
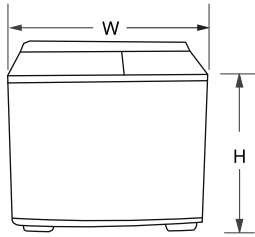

W	795	D	480	H	975
---	-----	---	-----	---	-----

Installation Place Requirements

Before installing the appliance, check the following information in order to install the appliance in a correct place.

Unpacking Shipping Material

- 1 Remove packing bands from the carton. Open upper flaps and fold them back. Lift off the carton. Remove the plastic bag and all other packing material.

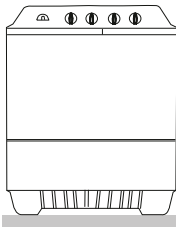

- 2 Lift the washing machine and remove the base packing.
- 3 Remove the tape securing the power supply cord and drain hose.
- 4 Remove the inlet hose and filter from the accessory bag.

Installation Location

Installation Area

- For placing & leveling the machine
 - Select flat & firm floor.



10 INSTALLATION

- Maintain more than 15 cm gap between the side of drain hose and the wall.

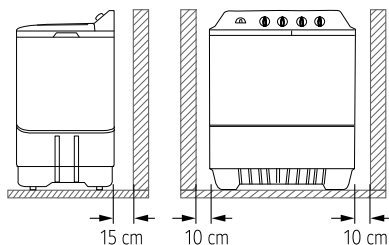

- The base openings must not be obstructed by carpeting when the washing machine is installed on a carpeted floor.

NOTE

- The machine has mobility function by manual intervention, care to be taken to avoid any body parts coming under wheels.
- Install the washing machine on a horizontal support. Otherwise, it may cause vibration and noise.
- Incorrect installation may cause severe noise and break down.

Connecting the earth wire (only for models with two prong plug)

- Install the earth wire to prevent short-circuit due to leaking current and electric shock.
- It is attached at the back of the washer. Connect it to the metal water pipe. If the water pipe is made of plastics, it does not have the earth effect.
- Do not connect the earth wire ① to the gas pipe ②, lightning arrester, telephone connector, etc.

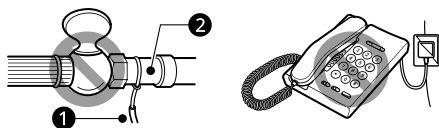

⚠ WARNING

- The appliance with two pronged plug must be grounded.

Connecting the power plug

- Insert the power plug into the outlet.
- Before connecting the power plug, check if the voltage setting of the washer matches the outlet voltage.
- If AC outlet with ground terminal is used, grounding is not needed. If not, never forget earthing (earthing method above).
- The appliance must be positioned so that the plug is accessible.

Other earthing method

- After connecting the earth wire ① to the earth cooper plate ②, bury it atleast 75 cm deep under the wet ground.

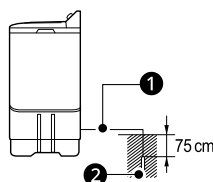

- Connect the earth wire ③ to the earthing-only outlet.

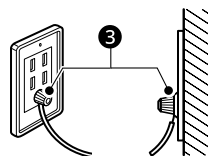

- If grounding method as described are not possible, a separate circuit-breaker ④ should be employed and installed by a qualified electrician.

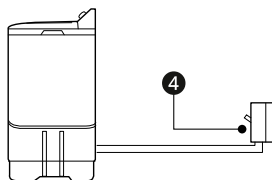

Installing the Drain Hose

Before connecting the drain hose, check your drain hose model and follow the instructions for that model.

Installing the Drain Hose

- 1 Fix the snap ring ① to the drain hose.

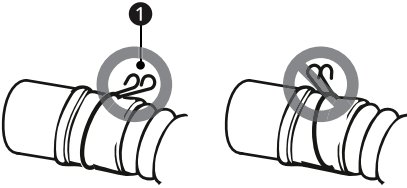

- 2 Align the drain hose with drain outlet

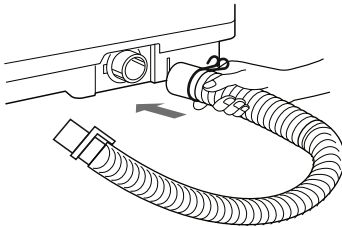

- 3 Press hose clip and push the hose towards the body of the washing machine and release the snap ring.

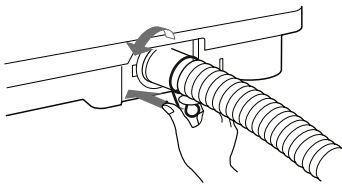

Positioning the Drain Hose

- Do not crush hose. Make sure to maintain gap of more than 15 cm between the side of drain hose and the wall.
- Make sure the drain hose is not kinked.

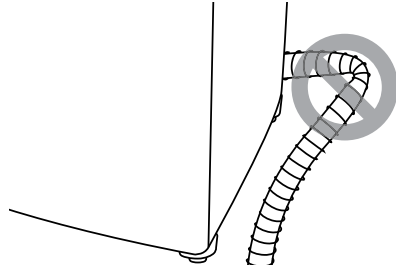

- Make sure water is drained smoothly by placing a base under the machine or by applying other appropriate mean.

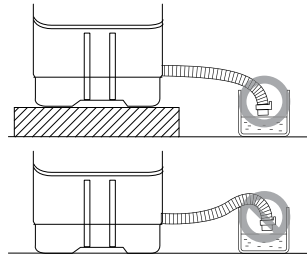

NOTE

- Be sure to re-route the drain hose so that it is not kinked or has sharp bends which will prevent proper drainage.
- Use only new hose set provided with the machine.

⚠ WARNING

- Packaging materials (such as plastic bags and thermocol) should be kept away from children.

OPERATION

Preparing the Wash Load

Sort the wash load for best washing results, and then prepare the clothes according to the symbols on their care labels.

Checking the Clothes before Loading

- To help distribute the load evenly during spinning, combine large and small items in a load.
- Do not wash single small items. Add 1-2 similar items to the load to prevent an out-of-balance load.
- Check all pockets to make sure that they are empty. Items such as nails, hair clips, matches, pens, coins and keys can damage both your appliance and clothes.

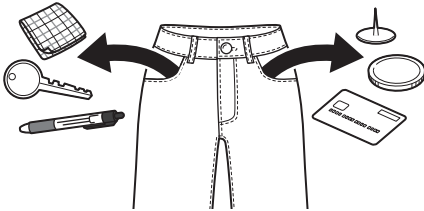

- Wash delicates (stockings, underwired bras) in a wash net.
- Close zippers, hooks and strings to make sure that these items do not snag on other clothes.
- Pre-treat dirt and stains by brushing a small amount of detergent dissolved water onto stains to help lift dirt.

Adding Detergents

Detergent Dosage

- Detergent should be selected according to fabric type, colour, soil level and washing temperature and should be used according to the detergent manufacturer's instructions.
- Too much detergent results in excessive suds which cause poor washing.

- When you use liquid detergent, follow the guidelines provided by the detergent manufacturer.
- Detergent usage may need to be adjusted for water temperature, water hardness, size and soil level of the laundry. For best results, avoid oversudsing.
- Refer to the label of the clothes, before choosing the detergent and water temperature.
- Use only suitable detergents for the respective type of clothing:
 - General powdered detergents for all types of fabric
 - Powdered detergents for delicate fabric
 - Liquid detergents for all types of fabric or designated detergents only for wool
- For better washing performance and whitening, use detergent that contains general powdered bleach.

⚠ CAUTION

- Using liquid detergent without diluting, or leaving laundry for a long time after pouring diluted liquid detergent into the drum might cause the clothes to be damaged, bleached, discoloured.

NOTE

- Do not let the detergent harden. Doing so may lead to blockages, poor rinse performance or odour.
 - Full load: According to manufacturer's recommendation.
 - Part load: 3/4 of the normal amount
 - Minimum load: 1/2 of full load
-

Control Panel

Control Panel and Functions

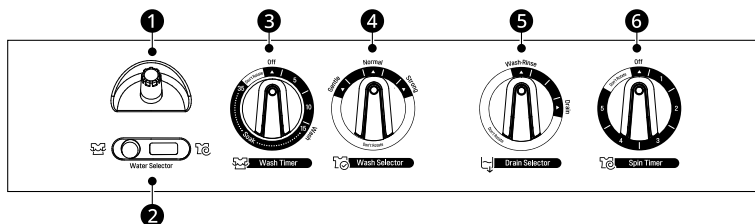

1 Water Supply Inlet

- Connect here with the Inlet hose from the water tap to feed water to the tub.

2 Water Selector

- Select **WASH** to supply water for washing and rinsing and **SPIN** for spin shower rinse.

3 Wash Timer

- The **Wash Timer** can be used for soak, wash and rinse operations. Select the desired time for soaking, washing or rinsing.

4 Wash Selector

- Set the selector to **Gentle**, **Normal**, **Strong** according to kinds and quantity of the laundry.

5 Drain Selector

- Select **Wash.Rinse** for washing and rinsing, and **Drain** to drain the water out of the tub.

6 Spin Timer

- Select the desired time for spinning. The maximum limit is 10 min, but should not be continued over 3 cycles.
- Don't rotate the knob more than prescribed limit.

NOTE

- After spinning continuously for 3 times, do not spin for more than 1 hour. Otherwise, the spin motor may be damaged, catch fire, or stop operating.

Operating the Appliance

Washing

1 Set the **Drain Selector** as **Wash.Rinse** Position.



2 Set the **Water Selector** to **WASH**.



3 Put the appropriate amount of detergent and the laundry into the wash tub. Add water to the desired water level. Refer to the **Guide for Washing** for further details.

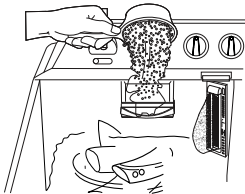

4 Open water supply and fill water till water level mark **H**. That is because clothes can absorb enough water, supplying adequate water for washing.

5 Select the **Wash Selector** to **Gentle, Normal, Strong** according to kinds and quantity of the laundry.



6 Set the desired wash time.



- In the period 0~15 min
 - The machine will run the washing function.
- In the period 16~35 min
 - The machine will switch between washing and soaking.

7 When washing is finished, select the **Drain Selector** to **DRAIN** position and drain the water out.



8 Spinning is done in the spin dryer basket. Move the laundry into spin dryer basket. Put the laundry down lightly. Place the safety cover horizontally on the laundry . Set the desired spin time with the **Spin Timer**.

Rinsing

Continuous water supply rinse

The course is to rinse while feeding water continuously.

1 Select the **Drain Selector** to **Wash.Rinse** position.



2 Put the laundry into the wash tub and open the water tap.

3 Set the rinse time with the **Wash Timer** and feed water continuously.



Interim spin rinse

Interim spin rinse prior to regular rinsing will remove sudsy water from the laundry and improve rinsing efficiency.

1 After washing

- Put the laundry into the spin dryer basket.
- Place the safety cover horizontally on the laundry.

2 Set the **Water Selector** to **SPIN** and open the tap.



3 Set the desired water flow and spin time appropriately.



4 After spinning, put the laundry into the wash tub and rinse.

⚠ CAUTION

- Do not operate the spin with water supply on.

Spinning

1 Put the laundry evenly into the spin dryer basket.

- Transfer the clothes from wash tub to spin dryer basket one by one.

2 Put the laundry down lightly.

3 Place the safety cover **2** horizontally on the top of the laundry inside the basket.

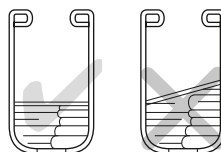

4 Close the safety cover-1 **1** and then spin dryer cover.

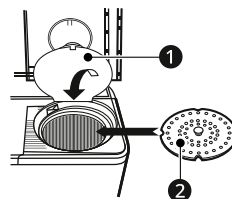

5 Set the **Spin Timer**.

Spin Time Guide

Type of clothing	Spin Time
Thin fabrics (synthetic fabrics, mixed fabrics) / Sweaters	1 min
Silk (synthetic fabrics)	1 - 3 min
Cotton underwear	3 - 5 min
Sheets / Towels	5 - 10 min

16 OPERATION

- Do not drain the water out of the wash tub while the spin dryer basket is in operation. Otherwise the spin motor could be damaged.
- If the spin dryer basket is off- balance and vibrates excessively, stop the spinning, rearrange the clothes evenly, and then resume spinning.
- If the spinning fail to stop when the spin dryer cover is opened, the brake is out of order. Immediately stop using the machine and request repair service.

NOTE

- For wollen clothes, spin for 1 min only for clothes protection.

CAUTION

- Do not continue Spin over 3 consecutive cycles. After 3 consecutive spin cycles, stop spinning more then 1 hour. Spin motor may stop operation or may be damaged.
-

After Finishing Wash

- 1** Remove the laundry from the spin dryer basket and close the spin dryer cover.
- 2** If there is water in the wash tub, set the **Drain Selector** to **Drain** in order to drain it out.
- 3** Disconnect the power cord from the electrical outlet.
- 4** Clean the washing machine.

MAINTENANCE

Cleaning after Every Wash

What to Clean

- If you always use cold water, we recommend that a warm or hot wash be used at regular intervals e.g. every 5th wash should be at least a warm one.
- Turn off taps after use to prevent the chance of flooding, otherwise an inlet hose may burst.
- Always unplug the power cord after use.
- After the cycle is finished, wipe the door and the inside of the door to remove any moisture.

⚠ WARNING

- Leave the door open to dry the drum interior but only if it is safe and any children are supervised.

Cleaning the Exterior

Proper care of the appliance can extend the service life.

Exterior

- Immediately wipe off any spills.
- Wipe with a damp cloth and then again with a dry cloth ensuring there is no moisture in cabinet joints or crevices.
- Do not press on the surface or the display with sharp objects.

Cleaning the Appliance Periodically

Cleaning the Lint Filter

The filter is an important part for an efficient washing performance result, so take a special care. Clean the filter regularly.

⚠ CAUTION

- Clean the lint filter after at least 2 - 3 washes.

- Do not drop the filter on the floor.
- Be careful not to get your fingernails caught in the filter when you handle the filter.
- Do not leave iron objects (such as clothes pins, hairpins, etc.) in the lint filter as they promote rust.

Overflow Filter and Rotation Filter-C

- 1 Lift up the area ❶ of the overflow filter. Take out the rotation filter-C by pulling in the direction shown.

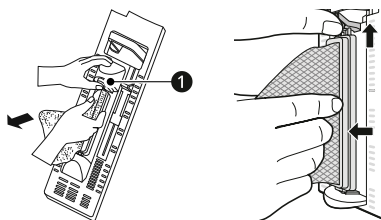

- 2 Pull the overflow filter forward from the wash tub.

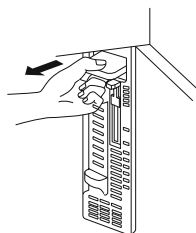

- 3 Turn the net over and rinse in water.



- 4** Use a brush or your hand to remove all of the lints which has adhered to the overflow filter.

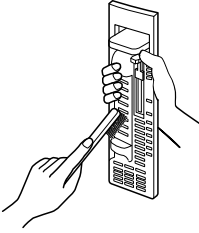

- 5** Insert the overflow filter back into the wash tub.

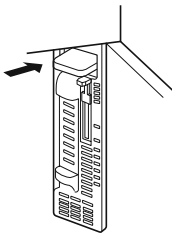

- 6** Insert the rotation filter-C back into the overflow filter.

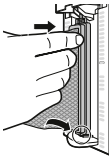

NOTE

- If only rotation filter-C need washing, follow the process 1>3>6 from the above.
-

Detergent Box

- 1** Pull the detergent box.

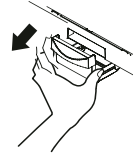

- 2** Press at side of detergent box and rotate downwards following the arrow direction.

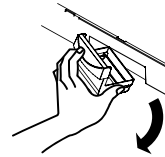

- 3** Clean the detergent box with water.

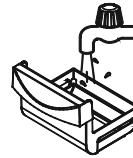

- 4** Slide the detergent box into place.

Caring the Appliance

Pulsator

If a button or some other object gets caught in the pulsator.

- 1 Take out the pulsator cap with "-" type screw driver.



- 2 Use a screwdriver to unscrew the screw in the center of the pulsator and lift the pulsator straight up in order to remove the button or other object.

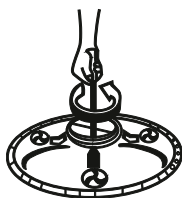

- 3 Place the pulsator at its original position and tighten the screw.

- 4 Place the pulsator cap at its original position.

Spin Dryer Basket

If clothing becomes trapped between the spin dryer basket and the spin tub.

- 1 Take hold of the front of the safety cover.

- 2 Firmly hold the tub ① by the other hand.

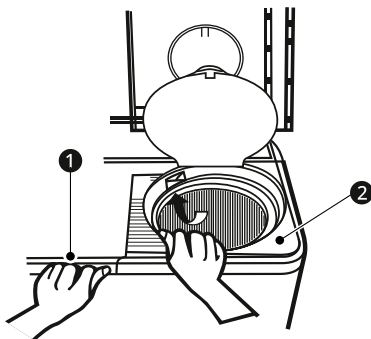

- 3 Pull the safety cover ② upward.

- 4 Remove the clothing.

- 5 Close the safety cover, pressing down on it so that it fits securely into the spin tub.

Water Leakage

In case water leakage is observed, rotate **Drain Selector** 5-7 times. By doing so, any obstructed foreign particle will drain off.

- Perform the above steps again, till the problem is resolved.

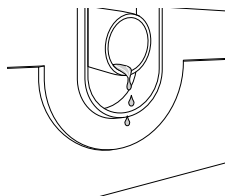

TROUBLESHOOTING

Before Calling for Service

Operation of the appliance can lead to errors and malfunctions. The following tables contain possible causes and notes for resolving an error message or malfunction. You can remedy most of the problems by yourself, consequently save time and money, since you do not need to call LG Electronics service centre. The following table should assist you by troubleshooting.

Operation

Symptoms	Possible Cause & Solution
Appliance will not operate.	Appliance is unplugged. <ul style="list-style-type: none"> Make sure that the cord is plugged securely into a working outlet.
	Controls are not set properly. <ul style="list-style-type: none"> Make sure the Wash Timer knob or the Spin Timer knob is not in the "0" position.
Appliance will not drain water.	Drain hose is kinked. <ul style="list-style-type: none"> Ensure that the drain hose is not kinked.
	Drain is located higher than 1.0 m above the floor. <ul style="list-style-type: none"> Make sure that the drain hose is no higher than 1.0 m above the bottom of the appliance.
Rattling and clanking noise	Foreign objects, such as keys, coins, or safety pins may be in the drum. <ul style="list-style-type: none"> Stop the appliance, check the drum for foreign objects. If noise continues after the appliance is restarted, call for service.
Thumping sound	Heavy laundry may produce a thumping sound. This is usually normal. <ul style="list-style-type: none"> If the sound continues, the appliance is probably out of balance. Stop and redistribute the laundry.
	The laundry may be out of balance. <ul style="list-style-type: none"> Pause the cycle and redistribute the laundry.
Vibrating noise	The laundry may be unevenly distributed in the drum. <ul style="list-style-type: none"> Pause the cycle and redistribute the laundry.

APPENDIX

Reference

Weight Guide for Clothes

Type of clothing	Type of fabric	Weight per piece
Under Shirt	Cotton	150 g (5.3 oz)
Handkerchief	Cotton	50 g (1.8 oz)
Bath Towel	Cotton	300 g (10.6 oz)
Shirt	Mixed Fabric	200 g (7.1 oz)
Socks (1 Pair)	Mixed fabric	50 g (1.8 oz)
Pajama (Shirt & Pants)	Cotton	500 g (17.6 oz)
Winter Undershirt	Woollen	600 g (21.2 oz)
Workclothes	Mixed Fabric	800 g (28.2 oz)
Blouse	Mixed Fabric	200 g (7.1 oz)

Guide for Washing

Refer to the following tables when washing.

Fabric type	Wash Selector	Amount of laundry (kg)	Water level	Amount of water (l)	Amount of detergent (g)
Synthetics, Silk, Delicate fabrics	Gentle	4.0 - 5.0	-	40	40
Cotton, Linen	Normal	5.0 - 6.5	-	50	50
Heavy soils Cotton, Linen	Strong	More than 6.5	H	60	60

NOTE

- Amount of laundry is based on dry laundry.
- Detergent amount is based on a general synthetic detergent.
- If washing and spinning must be operated together, starting washing and spinning operation shall be done at the same time to cope with EMC requirement.

Memo

Memo

