



OWNER'S MANUAL

# Flat Panel Digital X-ray Detector

---

Please read this manual carefully before operating your set and retain it for future reference.

17HQ901G-B

CE0123

[www.lg.com](http://www.lg.com)

Copyright © 2022 LG Electronics Inc. All Rights Reserved.

# CONTENTS

<b>OPEN SOURCE SOFTWARE NOTICE INFORMATION .....</b>	<b>3</b>
<b>ON CLEANING .....</b>	<b>3</b>
<b>GENERAL DESCRIPTION .....</b>	<b>4</b>
<b>NAMES AND FUNCTIONS OF COMPONENTS .....</b>	<b>7</b>
<b>ASSEMBLING BATTERY .....</b>	<b>15</b>
<b>REMOVING BATTERY .....</b>	<b>16</b>
<b>HOW TO USE MAIN CABLE HOLDER .....</b>	<b>18</b>
<b>SPECIFICATION AND DIMENSION OF EACH PART .....</b>	<b>19</b>
<b>ENVIRONMENTAL REQUIREMENT .....</b>	<b>23</b>
<b>INSTALLING CALIBRATION SOFTWARE .....</b>	<b>24</b>
<b>CONNECTION TYPE .....</b>	<b>25</b>

# OPEN SOURCE SOFTWARE NOTICE INFORMATION ON CLEANING

To obtain the source code that is contained in this product, under GPL, LGPL, MPL, and other open source licenses that have the obligation to disclose source code, and to access all referred license terms, copyright notices and other relevant documents, please visit <https://opensource.lge.com>.

LG Electronics will also provide open source code to you on CD-ROM for a charge covering the cost of performing such distribution (such as the cost of media, shipping, and handling) upon email request to [opensource@lge.com](mailto:opensource@lge.com).

This offer is valid to anyone in receipt of this information for a period of three years after our last shipment of this product.

## Recommended Cleaning Chemicals

- Isopropanol 70 %
- Ethanol 70 %
- 0.9 % NaCl solution
- Biospot 500 ppm

## How to Use Cleaner

- Prior to cleaning, turn off the Detector and remove the power cable.
- Soak a soft cloth in a recommended cleaner, then lightly rub the screen with no more than 1 N of force.
- The cleaner could cause serious damage if it leaks inside the Detector while cleaning.
- Do not use benzene, thinner, acids or alkaline cleaners or other such solvents.
- Cleaning guidelines for Detector must only be carried out by medical professionals (doctors or nurses) and must not be handled by patients.

# GENERAL DESCRIPTION

## Overview

This model is an x-ray imaging device, a system that can acquire and process X-ray images as digital images. It utilizes amorphous silicon and a high-performance scintillator to ensure sharp high-definition image quality with the resolution of 3.6 lp/mm and the pixel pitches of 140  $\mu\text{m}$ . This device is a flat panel based X-ray image acquisition device. This device must be used in conjunction with an operating PC and an X-ray generator. This device can be used for digitizing and transferring X-ray images for radiological diagnosis. The data transmission between the detector and PC can be enabled with a wired (cable) or wireless connection.

# Product Components

## Basic Accessories

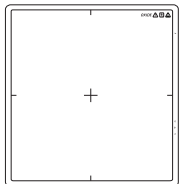

Detector

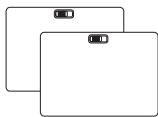

Battery 2 EA

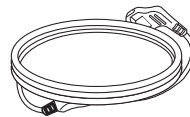

AC Power Cord for the AC Power Adapter



Inspection Report

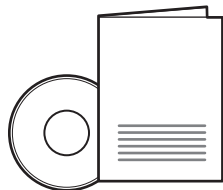

Owner's Manual/Regulatory Manual/Calibration Software

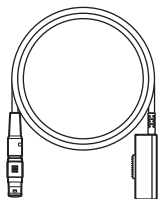

Main Cable

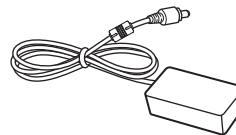

AC Power Adapter for Charger

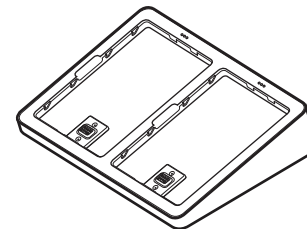

Battery Charger

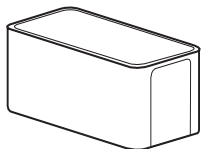

Control Box

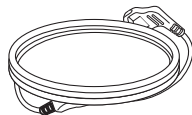

AC Power Cord for the Control Box

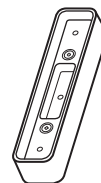

Main Cable Holder

## Optional Accessories

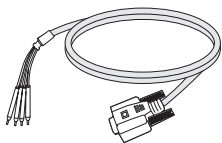

Trigger Cable

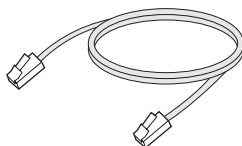

LAN Cable

- Some models may not include optional accessories.

### CAUTION

- You must use the authorised components as per the specification below. Unauthorised components may cause damage and/or cause the product to malfunction.

Component	Standard
LAN Cable	More than CAT5E Standard
Power Cord	US – Approved Medical grade regulation Others – Approved country safety regulation

- The AC/DC adapters etc. that are being used, with the exception of the upper components, must be supplied by the manufacturer.

# NAMES AND FUNCTIONS OF COMPONENTS

## Detector

Front

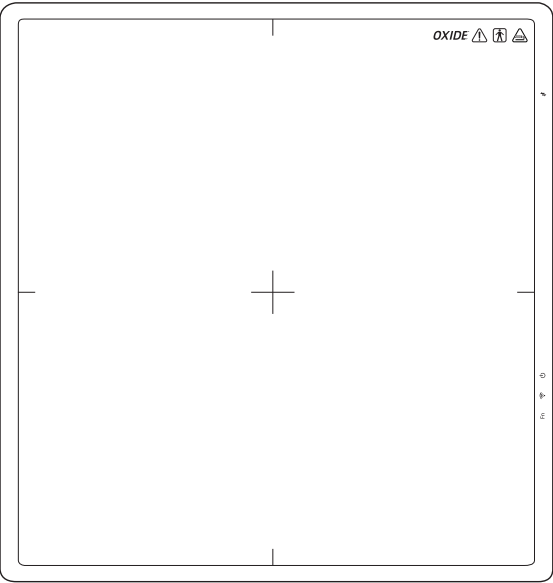

Back

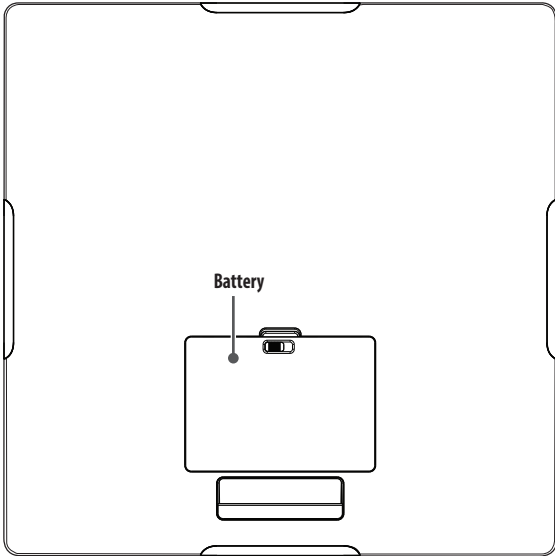



## Side



<b>1</b>	Connection to Main Cable
<b>2</b>	<p>⏻</p> <ul style="list-style-type: none"> <li>• Power LED Indicator</li> <li>• Power button</li> </ul>
<b>3</b>	<p>📶</p> <ul style="list-style-type: none"> <li>• Wired/Wireless LED Indicator</li> <li>• Wired/Wireless Connection Button</li> </ul>
<b>4</b>	<p>Fn</p> <ul style="list-style-type: none"> <li>• Function Switch LED Indicator</li> <li>• Function Switch Button</li> </ul>
<b>5</b>	OLED Indicator



## Button Information

Button	Description
 (Power button)	Press the Power button to turn the power on or off. <ul style="list-style-type: none"> <li>– On: Press and hold for 1 sec or longer</li> <li>– Off: Press and hold for 1 sec or longer</li> </ul>
 (Wired/Wireless Connection button)	Press this button for at least one second to switch between the following connection modes, in respective order: Ethernet/Station/AP mode.
Fn (Function Switch button)	Press this button for at least one second to switch between the following menus, in respective order: Check connection mode, video acquisition, image auto save. The menu is shown on the OLED indicator. <ul style="list-style-type: none"> <li>– Press and hold the Fn button for at least three seconds to change the on/off settings for each function.</li> </ul>



### NOTE

- Press and hold the  and Fn buttons at the same time for at least ten seconds to restore to factory settings.

## LED Indicator









LED	Description	
 (Power LED Indicator)	Displays the power and battery status of the detector.	
	Off	Power off
	White	Power on
	Orange	The battery level is greater than 10 % and less than 30%.
	Orange(blinking)	The battery level is less than 10%.
 (Wired/Wireless LED Indicator)	Displays the connection mode status of the detector.	
	Green	Ethernet connected
	Green(blinking)	Ethernet disconnected
	White	Wireless(Station/AP) connected
	White(blinking)	Wireless(Station/AP) disconnected
F <sub>n</sub> (LED Indicator for Function Switch)	Briefly lights up in green when the Function Switch button is used to change the on/off settings.	

### NOTE

- If the LED indicators show the following behaviour, a system error may have occurred. Please contact the manufacturer.
  -  +  + F<sub>n</sub>(Green(blinking))

## OLED Indicator

The OLED indicator displays the information below.

Connection Mode			Information
Ethernet	Station	AP	
999.999.999.999  Wired	999.999.999.999  STA SSID	999.999.999.999  AP AP SSID	Wired/STA/AP – Check Connection Mode (Ethernet/Station/AP).
Dynamic  On	Dynamic  On	Dynamic  On	Dynamic On/Off – Video Acquisition
Auto save  On (10/200)	Auto save  On (10/200)	Auto save  On (10/200)	Auto save On/Off (Up to 200 images) – Image Auto save





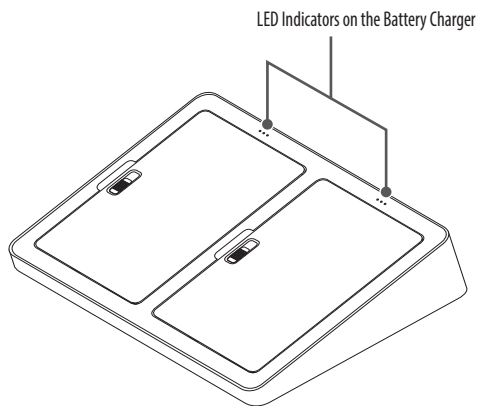

### NOTE

- The information displayed on the OLED indicator will vary depending on the connection mode (Ethernet/Station/AP).
- If left idle for ten seconds after pressing the FN button, the OLED indicator turns off. When the OLED indicator is turned on again, the starting screen is displayed.

## Battery and Battery Charger



<b>LED Indicators on the Battery Charger</b>				
<b>Remaining Battery Levels</b>	0 ~ 30 %	30 ~ 70 %	70 ~ 99 %	100 %
<b>Battery Status</b>	On charging			Completion of charging

### ! NOTE

- Battery: Lithium ion polymer battery (charging time - Typ. 3 hours)
- Battery Charger: 2-port cradle type
- The remaining battery level and status for each battery can be checked through the LED indicators on the battery charger.
- If the LED indicator does not turn on when charging the battery, it may be a connection error. Please reinstall the battery.

# Control Box

## Front

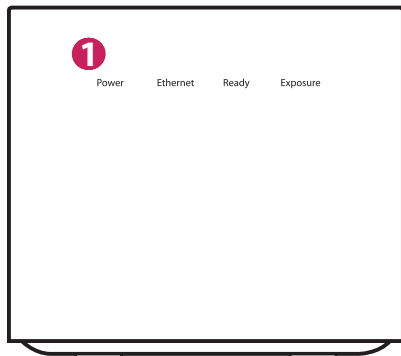

## Back

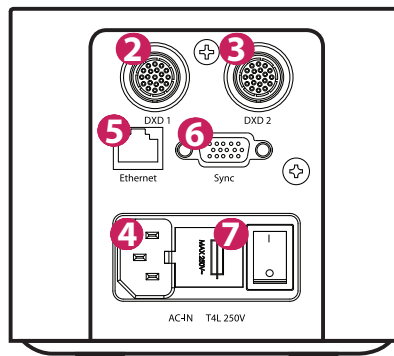

Number	LED Indicator	LED Colour	Description
1	Power	Green	Power normal operation
		Off	Power off (AC power cord no connection or Power error)
	Ethernet	Green	Ethernet normal operation
		Green(blinking)	On data communication
		Off	Ethernet disconnected
	Ready	Green	Ready signal from X-ray Generator is active
		Off	Ready signal from X-ray Generator is inactive
		Orange(blinking)	Power error
	Exposure	Orange	Exposure signal from X-ray Generator is active
		Off	Exposure signal from X-ray Generator is inactive
Orange(blinking)		Power error	

Number	Port	Description
2	DXD 1	Connects the Control Box to the Detector A. This connector supplies power (24 V --- 2.1 A) to the Detector and transmits the X-ray generator's sync signal and Ethernet image data.
3	DXD 2	Connects the Control Box to the Detector B. This connector supplies power (24 V --- 2.1 A) to the Detector and transmits the X-ray generator's sync signal and Ethernet image data. The Control Box supports connection to up to two detectors. One is for a bucky stand and the other is for a table (bed). Hospital X-ray examination rooms are typically equipped with both bucky stand and table type detectors. This makes it more convenient and efficient to use the detectors.
4	AC-IN	Connects the AC power cord.
5	Ethernet	An Ethernet port to transmit images/commands between the Detector and a PC.
6	Sync	Synchronizes the Detector and X-ray generator.
7	Fuse	Control box power fuses are 4 A, 250 V to Type T fuse. Power rating: T4L 250 V

# ASSEMBLING BATTERY

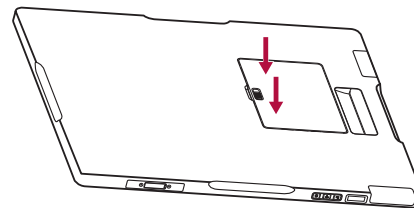
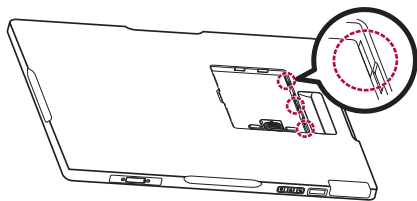
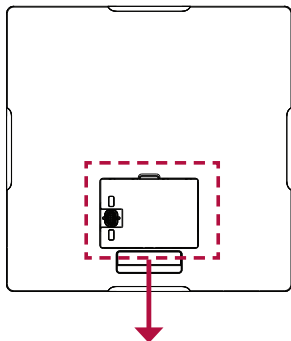

**1** Check the direction of the holes located inside the detector.

**2** Align the battery, and slide it into the holes inside the detector.

**3** Press the other side to assemble the battery.

# REMOVING BATTERY

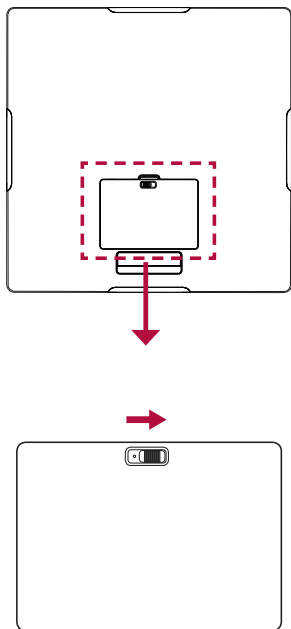

**1** Slide the battery lock button in the direction shown in the figure.

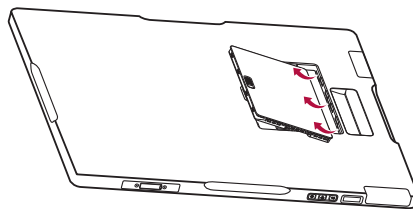

**2** Remove the battery by lifting it in the direction shown in the figure.

## Battery Hot-Swap

The detector is equipped with a hot-swappable battery. Hot-Swap is activated for one minute after the battery is removed from the detector.

### NOTE

- The detector will turn off if a charged battery is not inserted on time.
- Data collection and calibration functions are not available during a Hot-Swap.

## HOW TO USE MAIN CABLE HOLDER

- 1 Clean the wall before attaching the holder to it.
- 2 Attach the main cable holder using adhesive tape on the back.
- 3 Store the main cable of the detector in the holder.

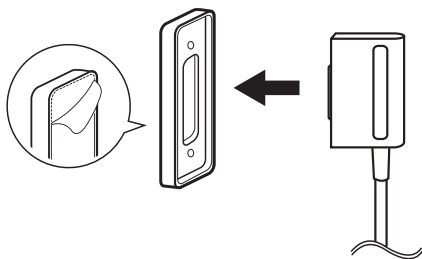

### ! NOTE

- The strength of the adhesive may be weakened depending on the environment. Avoid attaching the holder too high on the wall.
- Ensure that the holder is firmly fixed on the wall.
- Avoid storing anything other than the main cable.

# SPECIFICATION AND DIMENSION OF EACH PART

Specifications are subject to change without notice.

The symbol ~ means alternating current, and the symbol = = = means direct current.

## Specifications

### Detector

Item	Specifications
Model	17HQ901G
Sensor Type	Oxide TFT
Scintillator Type	CsI:Tl
Total Pixel Matrix	3072 x 3072 pixels
Total Pixel Area	430.08 mm x 430.08 mm
Pixel Pitch	140 um
Effective Pixel Matrix	3022 x 3022 pixels
A/D Conversion	16 bits
Data transmission	802.11 a/b/g/n/ac Wireless LAN Standard, 150 Mbps Wired Gigabit Ethernet Standard, 500 Mbps
Cycle time	Typ. 4.5 Sec (Wired) Typ. 5 Sec (Wireless)
Image Transmission	Typ. 1.5 Sec (Wired) Typ. 2 Sec (Wireless)
Image Save	Stores up to 200 images
Semi-dynamic mode	5fps @ 140 um (full FOV)
Energy Range	40 kVp ~ 150 kVp
MTF	Typ. 84 % @ 0.5 lp/mm
DQE	Typ. 78 % @ 0.1 lp/mm

Item	Specifications
Size (Width x Height x Depth) (mm)	460.0 x 460.0 x 15.6
Weight (kg)	Typ. 3.6
Window Materials	Carbon Fibre
Trigger Mode	Manual Mode Auto Mode (Auto Exposure Detection)
Power Consumption	Typ. 38 W
Wireless	Standard: 802.11 a/b/g/n/ac compliance Peak Mode: 867 Mbps Frequency: 2.4 GHz / 5 GHz Bandwidth: 20 MHz / 40 MHz / 80 MHz MIMO: 2 x 2
Rating	24 V = = = 2.1 A
Applied part	Type: BF Location: The front side of the Detector (Effective area only)

### NOTE

- Maximum wireless signal rate derived from IEEE standard specifications. Actual data throughput will vary. Network conditions and environmental factors, including volume of network traffic, building materials and construction, and network overhead, lower actual data throughput rate.
- Recommended Maximum operable distance: 2 m (From the Access Point)
- Wireless antennas: The module adopts the latest 802.11ac technology. The transmitter of the module is powered by host equipment (Detector). The antennas are 2 printed-dipole antennas.
- Wireless module: 802.11 a/b/g/n/ac USB 2.0 module is implemented. It supports 2T2R (2 transmit 2 receive) MIMO technology, which delivers throughput up to 300 Mbps.
- Images can be saved by the X-ray generator while the power of the detector is turned on without connecting to a PC. To produce images, X-ray is irradiated at intervals of more than 10 seconds. Check and load the saved images from LG Acquisition Workstation Software.

Detector has been tested with below table's X-ray condition. This table is only for reference. The legally certified radiologist expert should control X-ray dose.

- Sensor Type: a-Si TFT, X-ray conditions

	Adult			
	SID (inch / cm)	Tube Voltage (KV)	Tube Current (mA)	Tube Current x Time (mAs)
Chest P-A	72 inch / 182.8 cm	110 KV	320 mA	3.2 mAs
C-spine LAT	72 inch / 182.8 cm	75 KV	200 mA	20 mAs
L-spine A-P	40 inch / 101.6 cm	70 KV	250 mA	25 mAs
Abdomen A-P	40 inch / 101.6 cm	75 KV	320 mA	20.48 mAs
Pelvic A-P	40 inch / 101.6 cm	70 KV	250 mA	25 mAs
Wrist A-P	40 inch / 101.6 cm	50 KV	250 mA	5 mAs
Elbow A-P	40 inch / 101.6 cm	55 KV	250 mA	5 mAs
Shoulder AP	40 inch / 101.6 cm	65 KV	200 mA	8 mAs
Foot A-P	40 inch / 101.6 cm	50 KV	250 mA	5 mAs
Ankle A-P	40 inch / 101.6 cm	55 KV	100 mA	6.4 mAs
Knee A-P	40 inch / 101.6 cm	60 KV	100 mA	8 mAs

- Sensor Type: Oxide TFT, X-ray conditions

	Adult			
	SID (inch / cm)	Tube Voltage (KV)	Tube Current (mA)	Tube Current x Time (mAs)
Chest P-A	72 inch / 182.8 cm	110 KV	320 mA	2.56 mAs
C-spine LAT	72 inch / 182.8 cm	75 KV	200 mA	16 mAs
L-spine A-P	40 inch / 101.6 cm	70 KV	250 mA	20 mAs
Abdomen A-P	40 inch / 101.6 cm	75 KV	250 mA	16 mAs
Pelvic A-P	40 inch / 101.6 cm	70 KV	250 mA	20 mAs
Wrist A-P	40 inch / 101.6 cm	50 KV	200 mA	4 mAs
Elbow A-P	40 inch / 101.6 cm	55 KV	200 mA	4 mAs
Shoulder AP	40 inch / 101.6 cm	65 KV	200 mA	6.4 mAs
Foot A-P	40 inch / 101.6 cm	50 KV	200 mA	4 mAs
Ankle A-P	40 inch / 101.6 cm	55 KV	100 mA	4.8 mAs
Knee A-P	40 inch / 101.6 cm	60 KV	100 mA	6.4 mAs

### ! NOTE

- In the case of the Oxide TFT X-ray condition table, it is only applicable to 14HQ901G-B and 17HQ901G-B models. If the condition table is applied to other models, the desired image may not be obtained.
- Regarding paediatric dosage, it should be much less than for an adult. The certified radiologist should pay special attention to paediatric X-ray dosage levels.

## CAUTION

- Always use the detector in places that meet the following environmental requirements.

Item	Min	Max	Unit
Temperature (Storage)	-20	60	°C
Temperature (Operation)	10	35	°C
Humidity (Storage)	0	90	%, Non-condensing, Relative Humidity
Humidity (Operation)	0	80	
Pressure (Storage)	50	106	kPa
Pressure (Operation)	70	106	kPa

## GRID

Item	Recommended Specifications
SID	100 cm / 130 cm / 150 cm / 180 cm
Size	460 x 460 mm
Ratio	10:1
Frequency	215 Line / Inch
Inter Spacer	AL

## Battery

Item	Specifications
Model	LBS7222E
Size (Width x Height x Depth) (mm)	112.2 x 158 x 8.4
Weight (kg)	Typ. 0.2
Output Nominal voltage	Typ. 7.7 V ---
Operating Temperature	10 °C - 35 °C
Charging Time	When charged using the detector, Typ. 4 hours When two batteries are charged using the charger, Typ. 3 hours
Capacity	Typ. 4725 mAh, Min. 4300 mAh
Battery Performance	Typ. 7.5 hours (90-second shooting cycle, battery fully charged)

## NOTE

- The capacity of the battery pack decreases as the usage period increases.
  - The longer the period of use, the higher the possibility that the detector's operating time has become shorter.
  - The battery pack can be replaced at the end of its life. To obtain a replacement, please contact the manufacturer.

## Battery Charger

Item	Specifications
Model	LG Battery Charger
Size (Width x Height x Depth) (mm)	268.4 x 54.9 x 186.9
Weight (kg)	Typ. 0.52 (excluding the battery)
Input	19 V --- 3.42 A
Output Nominal voltage	8.7 V ---

## Battery Charger Adapter

Item	Specifications
Model	DA-65J19
Manufacturer	Asian Power Devices Inc. (APD)
Size (Width x Height x Depth) (mm)	134.0 x 59.8 x 31
Weight (kg)	Typ. 0.34
Input	AC 100-240 V~ 50-60 Hz, 1.5-0.7 A
Output	19 V --- 3.42 A
Classification by protection type against Electric Shock	Class I equipment
Cable Length (m)	1.5

## Control Box

Item	Specifications
Model	LG Control Box
Size (Width x Height x Depth) (mm)	125.0 x 109.8 x 255.0
Weight (kg)	Typ. 1.3
Input	AC 100-240 V~ 50/60 Hz, 1.4-0.7 A
Output	DXD 1 24 V --- 2.1 A, Trigger Signal, Ethernet Data from the detector A.
	DXD 2 24 V --- 2.1 A, Trigger Signal, Ethernet Data from the detector B.
	Ethernet An Ethernet port to transmit images/commands between the detector and a PC.
	Sync Synchronizes the detector and X-ray generator.

## Cables

Item	Length	Qty
Main Cable	7 m	1
LAN Cable (Optional)	10 m	1
Power Cord (110 V or 220 V)	1.5 m	2
Trigger Cable (Optional)	15 m	1

## Wireless module (LGSBWAC93) Specifications

Wireless LAN (IEEE 802.11a/b/g/n/ac)	
Frequency Range	Output power (Max.)
2400 to 2483.5 MHz	20 dBm
5150 to 5350 MHz	23 dBm
5470 to 5725 MHz	23 dBm
5725 to 5850 MHz	13.98 dBm

- As band channels can vary per country, the user cannot change or adjust the operating frequency. This product is configured for the regional frequency table.

\*IEEE 802.11ac is not available in all countries.

# ENVIRONMENTAL REQUIREMENT

## PC System Requirements

PC Specifications	
CPU	Intel i5
RAM	8 GB
Disk capacity	500 GB or more recommended
Network Card	Dual Ethernet 100/1000 Mbps
OS	Windows 7/8.1/10 (64 bit)
Monitor	Min Resolution 1920 x 1080
AP	Cisco models recommended (e.g. Linksys EA9200)

# INSTALLING CALIBRATION SOFTWARE

## How to Install

Launch the installation file of Calibration Software. After the installation file is launched, follow the instructions displayed on the screen to complete the installation.

## How to Uninstall

To remove Calibration Software from your PC, read and follow the steps below:

### Uninstall in the Control Panel

- 1 Click and launch Control Panel in your Start menu.
- 2 Select Programs and Features in Control Panel.
- 3 Select [LG DXD Calibration] from the list of the installed programs.
- 4 Select the [Delete] button when the screen for installation and uninstallation of the program appears.
- 5 Follow the on-screen prompts for proceeding uninstallation and click the [Next] button to complete uninstallation.

### Uninstall using the Installation File

Launch the installation file of Calibration Software and follow the instructions on the screen for uninstallation to complete the operation.

#### NOTE

- To uninstall the program using the installation file, make sure to run the installation file of the same version as the software installed in the PC.

# CONNECTION TYPE

## Connection of X-ray Generator - Detector

Select the trigger mode according to the image acquisition method.

- Auto mode: The detector automatically detects and acquires X-ray images.
- Manual mode: The detector recognizes the X-ray generator signals and acquires images.

## Connection of Detector - PC

The status of the connection between the detector and a PC

- Wired Mode: The wired connection between the detector and a PC through the Control Box
- Wireless (STA) mode: The wireless connection between the detector and a PC through a wireless AP
- Wireless (AP) mode: Wireless connection between the detector and a PC through the Soft AP function

## Network Connection Mode

Select the network connection mode using  (Wired/Wireless Connection button).

- Press  (Wired/Wireless Connection button) for at least one second to switch between the following connection modes, in respective order: Ethernet/Station/AP mode.

## Trigger Cable

The trigger cable is connected to the control box and X-ray Generator. It can only be used in manual mode, and not in automatic mode.

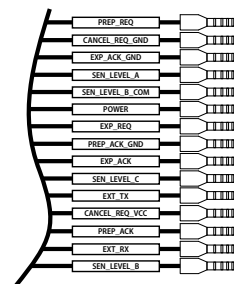
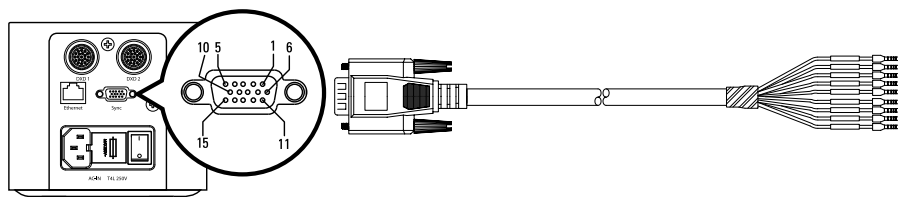

Pin Label

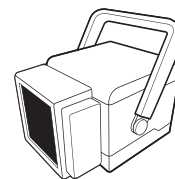

X-ray Generator

Number	Pin Label	Description
1	PREP_REQ	Prepare the signal from the X-ray generator to the control box.
2	CANCEL_REQ_GND	Cancel REQ ground.
3	EXP_ACK_GND	Signal ground
4	SEN_LEVEL_A	READY
5	SEN_LEVEL_B_COM	READY
6	POWER	Power: X-ray generator supply voltage (DC 12 V to 24 V)
7	EXP_REQ	Expose the signal from the X-ray generator to the control box.
8	PREP_ACK_GND	Prepare ground check.
9	EXP_ACK	Expose the acknowledgement signal from the control box to the X-ray generator.
10	SEN_LEVEL_C	READY
11	EXT_TX	READY
12	CANCEL_REQ_VCC	Cancel VCC request.
13	PREP_ACK	Prepare a confirmation signal from the control box to the X-ray generator.
14	EXT_RX	READY
15	SEN_LEVEL_B	READY

**!** **NOTE**

- Connection of trigger cable and X-ray generator is to be performed by qualified personnel. The description of each pin is in the common language for this industry.

# Block diagram of Trigger Cable connection

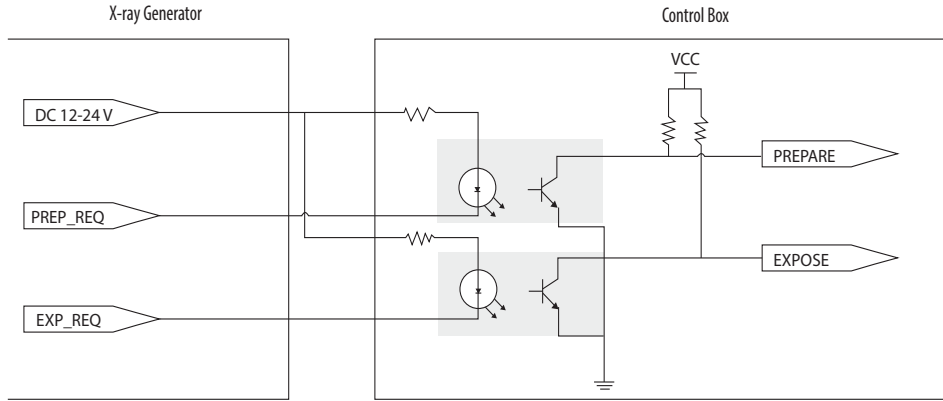

<Connection of X-ray Generator - Control Box>

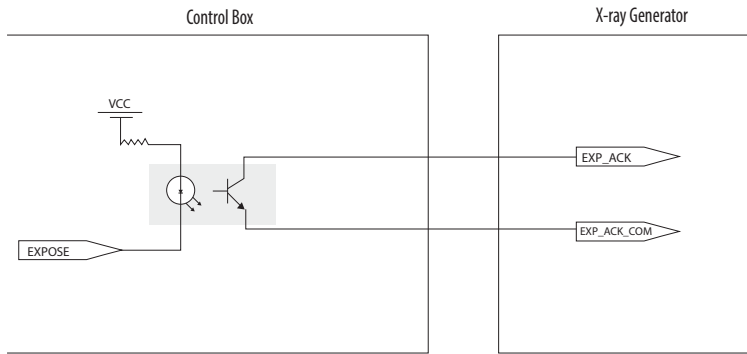

<Assembly Diagram>

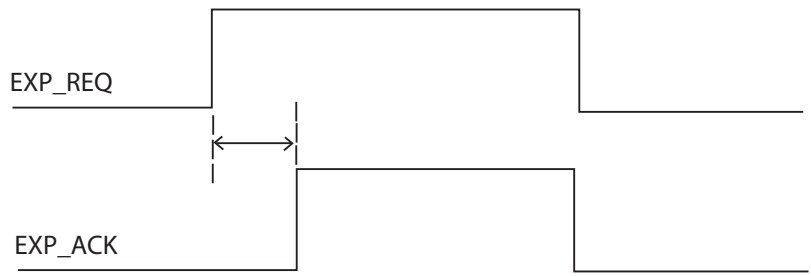

<Timing Chart>

## Connecting Detector to PC (Wired Mode)

A: Detector

B: Main Cable

C: Control Box

D: LAN Cable

E: PC

F: Object

G: X-ray Switch

H: Power Cord (AC 100-240 V~)

I: X-ray Generator

J: X-ray Generator Interface

K: Trigger Cable

Auto Mode

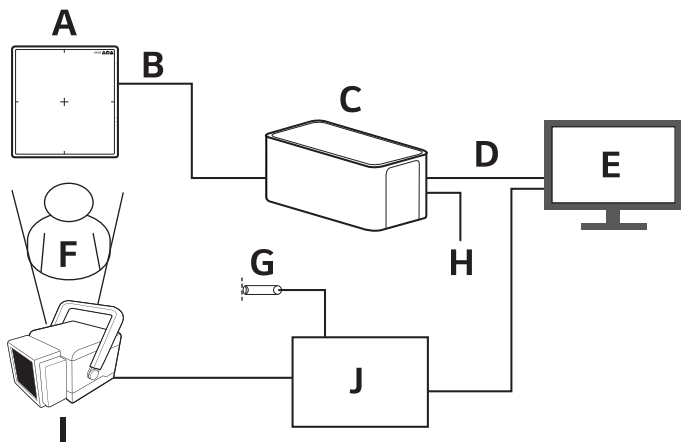

Manual Mode

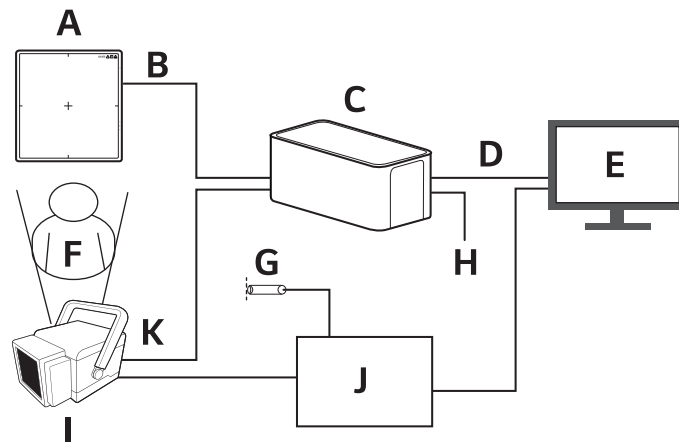

## Connecting the Cables

Main Cable: Connects the control box to the detector.

Up to two detectors can be connected, and both ports can be used by one detector.

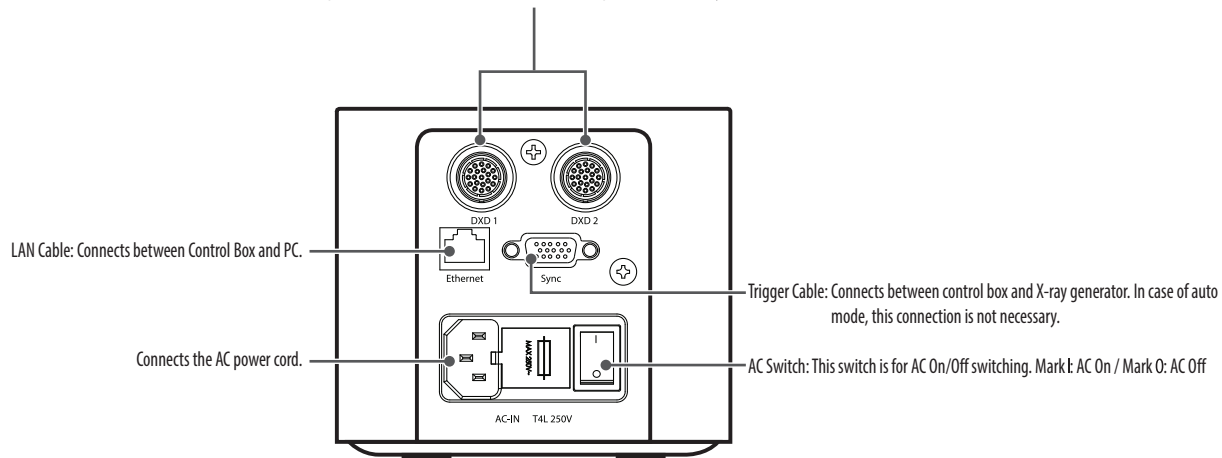

**Connect - Wired Connection**

Use the LAN cable to connect a PC to the Control Box and connect the detector to the Control Box with the main cable. After connecting the cables, proceed to set up the PC as shown below.

- 1 Launch the [Network and Sharing Center] and click [Change adapter settings].
  - Control Panel > Network and Internet > Network and Sharing Center > Change adapter settings
- 2 Go to [Properties] in Local Area Connection.
- 3 Select [Internet Protocol Version 4 (TCP/IPv4)] and then click [Properties] to set the IP address as follows:
  - IP address: 10.10.10.2 ~ 10.10.10.254 (set an IP address other than 10.10.10.99, 10.10.10.100)
  - [Subnet Mask]: 255.255.255.0
  - [Default Gateway]: 10.10.10.1
  - Do not set up DNS.

- 4 Launch Calibration Software, go to  (Settings) > [DXD] > [Connection & File Save] and enter the detector's IP (10.10.10.100). Click the [Ping] button to check the connection.

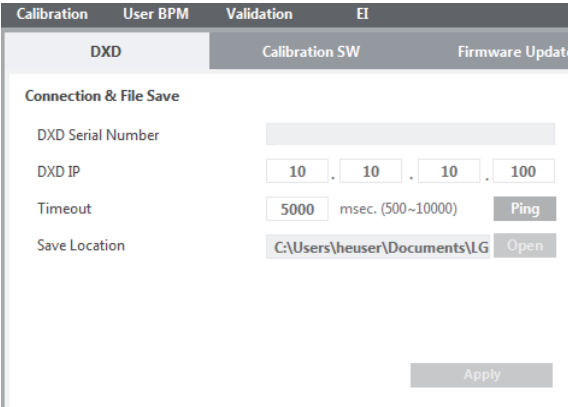

The screenshot shows a window titled 'Calibration' with tabs for 'User BPM', 'Validation', and 'EI'. The 'DXD' tab is active, and the 'Connection & File Save' section is expanded. The fields are as follows:

DXD	Calibration SW	Firmware Update
<b>Connection &amp; File Save</b>		
DXD Serial Number	<input type="text"/>	
DXD IP	<input type="text" value="10"/> . <input type="text" value="10"/> . <input type="text" value="10"/> . <input type="text" value="100"/>	
Timeout	<input type="text" value="5000"/> msec. (500~10000)	<input type="button" value="Ping"/>
Save Location	<input type="text" value="C:\Users\heuser\Documents\LG"/> <input type="button" value="Open"/>	
<input type="button" value="Apply"/>		

- Press the [Ping] button. If connected successfully, the following pop-up will appear:

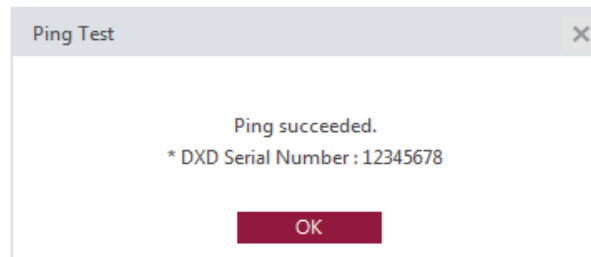

## Connecting Detector to PC (Wireless Mode)

A: Detector  
B: AP  
C: LAN Cable  
D: PC  
E: Object  
F: X-ray Switch

G: X-ray Generator  
H: X-ray Generator Interface  
I: Main Cable

J: Control Box  
K: Power Cord (AC 100-240 V~)  
L: Trigger Cable

### Auto Mode

#### 1. Station mode (for the use of external AP)

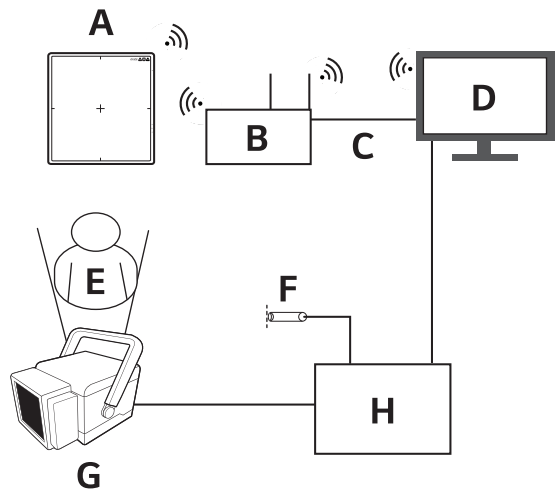

#### 2. AP mode (for the use of detector internal AP)

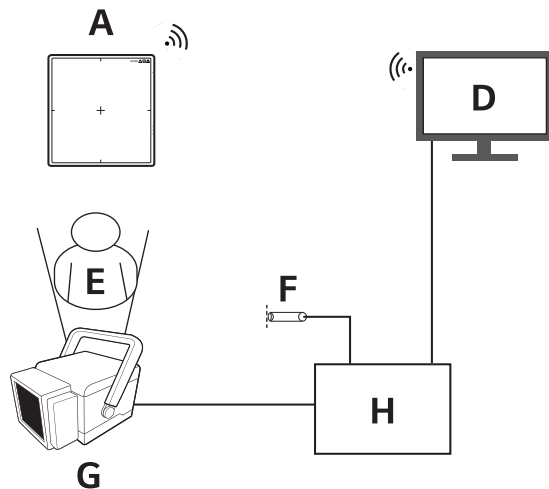

### ! NOTE

- Please install the AP and Detector as near as possible without obstacles in between them.

Manual Mode

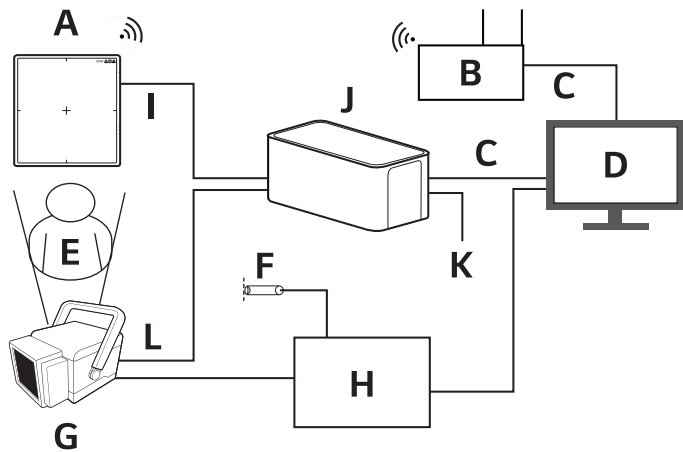

## Making connections-Wireless connection

- 1 The wireless factory default settings are as follows:
  - Station mode (connection via external AP)
    - SSID: LGEDXD
  - AP mode (connection via detector AP)
    - SSID: LGEDXD\_SOFTAP
- 2 It is possible to change the Wireless Settings using LG DXD Calibration Software.
  - Please see "Wireless AP Settings" for details.
- 3 Press  (Wired/Wireless Connection button) for at least one second to switch between the following connection modes, in respective order: Ethernet/Station/AP mode.
- 4 The Connection method as below.
  - Station mode
    - PC settings and connection with Detector are same with wired Connection.
  - AP mode
    - Enter [Wi-Fi] under PC Settings, and enter [Show available networks].
    - Attempts are made to connect after checking the DXD wireless AP SSID, which is shown as the research result (the initial value is LGEDXD\_SOFTAP). Enter the password to connect.
    - If the ping test fails despite the wireless connection being complete, please enter the IP address as follows:
      1. Launch the [Network and Sharing Center] and click [Change adapter settings].
        - (Control Panel > Network and Internet > Network and Sharing Center > Change adapter settings)
        - Select a network adapter.
      2. Go to [Properties] in Local Area Connection.
      3. Select [Internet Protocol Version 4 (TCP/IPv4)] and then click [Properties] to set the IP address as follows:
        - IP address: 10.10.10.2 ~ 10.10.10.254 (set an IP address other than 10.10.10.99, 10.10.10.100)
        - [Subnet Mask]: 255.255.255.0
        - [Default Gateway]: 10.10.10.1
        - Do not set up DNS.

## ! NOTE

- Refer to the wireless access point setup guide.
  - "Wireless Access Point Setup Guide (Model: Cisco Linksys EA9200)"



The model and serial number of the product are located on the back and on one side of the product. Record them below in case you ever need service.

Model

---

Serial No.

---

**(Australia only)**

This product must be installed by a professional installer.

After the installation of the product in the customer premises, fully remove all product packaging (including any expanded or moulded plastic packaging materials) and recycle or dispose of such packaging responsibly. Do not dispose any expanded plastic packaging in the household bin.

**WARNING:** This equipment is compliant with Class A of CISPR 32. In a residential environment this equipment may cause radio interference.