

Scan the QR code to see the manual.



LG SIGNATURE

OWNER'S MANUAL

WINE CELLAR



Before beginning installation, read these instructions carefully. This will simplify installation and ensure that the product is installed correctly and safely. Leave these instructions near the product after installation for future reference.

ENGLISH



MFL71467804
Rev.04_011124

www.LGSIGNATURE.com

Copyright © 2020-2024 LG Electronics Inc. All Rights Reserved.

TABLE OF CONTENTS

This manual may contain images or content that may be different from the model you purchased.
This manual is subject to revision by the manufacturer.

SAFETY INSTRUCTIONS

READ ALL INSTRUCTIONS BEFORE USE..... 4
WARNING 4
CAUTION 11
CARING FOR THE ENVIRONMENT 13

INSTALLATION

Before Installation 14
Levelling the Appliance 14
Turning on the Power..... 15
Moving the Appliance for Relocation 15

OPERATION

Before Use 17
Product Features..... 19
Control Panel 22
Automatic Opening Door 25
InstaView..... 25
Storing Wine 26
Storage Racks 27
Shelf 29
Auto-lift Device 29

SMART FUNCTIONS

LG ThinQ Application 34
Using the Voice Assistant..... 36
Smart Diagnosis 37

MAINTENANCE

Cleaning 39
Air Filter 40

TROUBLESHOOTING

Before Calling for Service.....41

SAFETY INSTRUCTIONS

READ ALL INSTRUCTIONS BEFORE USE

The following safety guidelines are intended to prevent unforeseen risks or damage from unsafe or incorrect operation of the appliance. The guidelines are separated into 'WARNING' and 'CAUTION' as described below.

Safety Messages



This symbol is displayed to indicate matters and operations that can cause risk. Read the part with this symbol carefully and follow the instructions in order to avoid risk.



WARNING

This indicates that the failure to follow the instructions can cause serious injury or death.



CAUTION

This indicates that the failure to follow the instructions can cause the minor injury or damage to the product.

WARNING

WARNING

- To reduce the risk of explosion, fire, death, electric shock, injury or scalding to persons when using this product, follow basic precautions, including the following:
-

Technical Safety

- This appliance can be used by children aged from 8 years and above and persons with reduced physical, sensory or mental capabilities or lack of experience and knowledge if they have been given supervision or instruction concerning use of the appliance in a safe way and understand the hazards involved. Children shall not play with the

appliance. Cleaning and user maintenance shall not be made by children without supervision.

- This appliance is not intended for use by persons (including children) with reduced physical, sensory or mental capabilities, or lack of experience and knowledge, unless they have been given supervision or instruction concerning use of the appliance by a person responsible for their safety. Children should be supervised to ensure that they do not play with the appliance.
- Children aged from 3 to 8 years are allowed to load and unload refrigerating appliances.
- This appliance is intended to be used in household and similar applications such as:
 - staff kitchen areas in shops, offices and other working environments;
 - farm houses and by clients in hotels, motels and other residential type environments;
 - bed and breakfast type environments;
 - catering and similar non-retail applications.
- This refrigerating appliance is not intended to be used as a built-in appliance.



This symbol alerts you to flammable materials that can ignite and cause a fire if you do not take care.

- This appliance contains a small amount of isobutane refrigerant (R600a), but it is also combustible. When transporting and installing the appliance, care should be taken to ensure that no parts of the refrigerating circuit are damaged.
- The refrigerant and insulation blowing gas used in the appliance require special disposal procedures. Consult with service agent or a similarly qualified person before disposing of them.
- Do not damage the refrigerant circuit.

- If the power cord is damaged or the hole of the outlet socket is loose, it must be replaced. Do not use the power cord and contact an authorized service centre in order to avoid a hazard.
- Do not locate multiple portable socket-outlets or portable power supplies at the rear of the appliance.
- Securely plug the power plug in the outlet socket after completely removing any moisture and dust.
- Never unplug the appliance from the power supply by pulling on the power cable. Always grip the power plug firmly and pull straight out from the outlet socket.
- Keep ventilation openings, in the appliance enclosure or in the built-in structure, clear of obstruction.
- Do not store explosive substances such as aerosol cans with a flammable propellant in this appliance.
- Transport the appliance upright only and do not tilt it.
- When positioning the appliance, ensure the supply cord is not trapped or damaged.
- Do not use mechanical devices or other means to accelerate the defrosting process.
- Do not use a hair drier to dry the inside of the appliance or place a candle inside to remove the odours.
- Do not use electrical appliances inside the food storage compartments of the appliance, unless they are of the type recommended by the manufacturer.
- Make sure not to get a body part such as a hand or foot stuck while moving the appliance.
- Disconnect the power cord before cleaning the appliance interior or exterior.
- Do not spray water or inflammable substances (toothpaste, alcohol, thinner, benzene, flammable liquid, abrasive, etc.) over the interior or exterior of the appliance to clean it.
- Do not clean the appliance with brushes, cloths or sponges with rough surfaces or which are made of metallic material.

- Only qualified service personnel from LG Electronics service centre should disassemble or repair the appliance.

Risk of Fire and Flammable Materials

- If a leak is detected, avoid any naked flames or potential sources of ignition and air the room in which the appliance is standing for several minutes. In order to avoid the creation of a flammable gas air mixture if a leak in the refrigerating circuit occurs, the size of the room in which the appliance is used should correspond to the amount of refrigerant used. The room must be 1 m² in size for every 8 g of R600a refrigerant inside the appliance.
- Refrigerant leaking out of the pipes could ignite or cause an explosion.
- The amount of refrigerant in your particular appliance is shown on the identification plate inside the appliance.

Installation

- This appliance should only be transported by two or more people holding the appliance securely.
- Install the appliance on a firm and level floor.
- Do not install the appliance in a damp and dusty place. Do not install or store the appliance in any outdoor area, or any area that is subject to weathering conditions such as direct sunlight, wind, rain, or temperatures below freezing.
- Do not place the appliance in direct sunlight or expose it to the heat from heating appliances such as stoves or heaters.
- Be careful not to expose the rear of the appliance when installing.
- Install the appliance in a place where it is easy to unplug the power plug of the appliance.
- Be careful not to let the appliance door fall during assembly or disassembly.
- Be careful not to pinch, crush, or damage the power cable during assembly or disassembly of the appliance door.

- Be careful not to point the power plug up or let the appliance lean against the power plug.
- Do not modify or extend the power cable.
- Ensure that the outlet socket is properly grounded, and that the earth pin on the power cord is not damaged or removed from the power plug. For more details on grounding, inquire at an LG Electronics customer information centre.
- This appliance is equipped with a power cord having an equipment-grounding conductor and a grounding power plug. The power plug must be plugged into an appropriate outlet socket that is installed and grounded in accordance with all local codes and ordinances.
- Never start up an appliance showing any signs of damage. If in doubt, consult your dealer.
- Dispose of all packaging materials (such as plastic bags and styrofoam) away from children. The packaging materials can cause suffocation.
- Do not plug the appliance into a multi socket adapter which does not have a power cable (mounted).
- The appliance should be connected to a dedicated power line which is separately fused.
- Do not use a multi-socket outlet which is not properly grounded (portable). It must comply with the technical specifications of the appliance and may only be used for the appliance.

Operation

- Do not use the appliance for any purpose (storage of medical or experimental materials or shipping) other than any domestic household food storage use.
- If water penetrates electrical parts of the appliance, disconnect power plug and contact an LG Electronics customer information centre.
- Unplug the power plug during a severe thunderstorm or lightening or when not in use for a long period of time.

- Do not touch the power plug or the appliance controls with wet hands.
- Do not bend the power cable excessively or place a heavy object on it.
- Immediately unplug the power plug and contact an LG Electronics customer information centre if you detect a strange sound, odour, or smoke coming from the appliance.
- Do not place hands or metallic objects inside the area emitting the cold air, cover or heat releasing grille on the back.
- Do not apply excessive force or impact to the back cover of the appliance.
- Be careful of nearby children when you open or close the appliance door. The door may bump the child and cause injury.
- Avoid the danger of children getting trapped inside the appliance. A child trapped inside the appliance can cause suffocation.
- Do not put animals, such as pets into the appliance.
- Do not place heavy or fragile objects, containers filled with liquid, combustible substances, flammable objects (such as candles, lamps, etc.), or heating devices (such as stoves, heaters, etc.) on the appliance.
- Do not place any electronic appliance (such as heater and mobile phone) inside the appliance.
- If there is a gas leakage (isobutane, propane, natural gas, etc.), do not touch the appliance or power plug and ventilate the area immediately. This appliance uses a refrigerant gas (isobutane, R600a). Although it uses a small amount of the gas, it is still combustible gas. Gas leakage during appliance transport, installation or operation can cause fire, explosion or injury if sparks are caused.
- Do not use or store flammable or combustible substances (ether, benzene, alcohol, chemical, LPG, combustible spray, insecticide, air freshener, cosmetics, etc.) near the appliance.
- This appliance incorporates an earth connection for functional purposes.
- Connect to potable water supply only.

- If connected to a water supply, connect to a potable water supply only.
- Fill with potable water only.
 - If using an icemaker or dispenser water tank, make sure to fill it with potable water only.

Auto-lift Feature

- The auto-lift drawer function can be used by children aged 8 years and above and persons with reduced physical, sensory or mental capabilities or lack of experience and knowledge if they have been given supervision or instruction concerning its use in a safe way and understand the hazards involved. The function can be turned off in the control panel, if desired.
- Do not allow children to play with or climb inside the drawer's inner compartment.
- Do not use the auto-lift function while folding the rear drawer back cover.
- Do not put your hand in the open areas at the sides or back of the drawer when open.
- Keep feet away from the bottom drawer when using the auto-open feature.
- Turn off the appliance before cleaning the bottom drawer compartment.
- The auto-lift device is heavy, so remove it with both hands.
- Do not unlock the locking knob of auto-lift device. The device could be activated, unfold, and be damaged.

Disposal

- When discarding the appliance, remove the door gasket while leaving the shelves and baskets in place and keep children away from the appliance.

CAUTION

CAUTION

- To reduce the risk of minor injury to persons, malfunction, or damage to the product or property when using this product, follow basic precautions, including the following:

Installation

- After unpacking, check the appliance for any damage that may have occurred during transit.
- Wait for at least 3 to 4 hours in order to ensure the refrigerant circuit is fully efficient.
- Move the appliance carefully on sensitive floors to avoid damage to the floor.

Operation

- Do not touch frozen food or the metal parts in the freezer compartment with wet or damp hands. It may cause frostbite.
- Do not place glass containers, bottles or cans (especially those containing carbonated drinks) in the freezer compartment, shelves or ice bin that will be exposed to temperatures below freezing. Contents may expand when frozen, break the container and cause injury.
- The tempered glass on the front side of the appliance door or the shelves can be damaged by an impact. If it is broken, do not touch it with hands.
- Do not hang from the appliance doors, storage room, shelf or climb up into it.
- Do not store an excessive amount of water bottles or containers for side dishes on the door baskets.
- Do not open or close the appliance door with excessive force.
- If the hinge of the appliance door is damaged or operates improperly, stop using the appliance and contact an authorized service centre.

- Prevent animals from nibbling on the power cable or water hose.
- Never eat frozen foods immediately after they have been taken out in the freezer compartment. There is a risk of freezing or the formation of frost blisters. FIRST AID: Immediately hold it under cold running water. Do not pull it away.
- Make sure not to get a hand or foot stuck upon opening or closing the appliance door or door in door.

Wine Storage

- Pull wine racks open gently. Jerking the racks out may cause bottles to fall.
- Store only wine bottles in the wine storage compartment. The temperature of the compartment is too high to safely preserve refrigerated foods.

Maintenance

- This appliance is equipped with maintenance-free LED interior light. Do not remove cover or LED lamp in any attempt to repair or change it. Contact an LG Electronics customer information centre.
- Do not clean glass shelves or covers with warm water when they are cold. They may shatter if exposed to sudden temperature changes.
- Do not insert the shelves upside down. The shelves may fall.
- If ice forms in the freezer compartment, please contact LG Electronics customer service. Do not use sharp-edged objects to remove any frost or ice build-up. Do not use sprays, electric heating devices such as fan heaters, hair dryers, steam cleaners or other heat sources for defrosting. Plastic parts could deform.
- Dispose of the ice inside the ice bin in the freezer compartment during an extended power outage.

CARING FOR THE ENVIRONMENT

Disposal of Your Old Appliance



- This crossed-out wheeled bin symbol indicates that waste electrical and electronic products (WEEE) should be disposed of separately from the municipal waste stream.
- Old electrical products can contain hazardous substances so correct disposal of your old appliance will help prevent potential negative consequences for the environment and human health. Your old appliance may contain reusable parts that could be used to repair other products, and other valuable materials that can be recycled to conserve limited resources.
- You can take your appliance either to the shop where you purchased the product, or contact your local government waste office for details of your nearest authorised WEEE collection point. For the most up to date information for your country please see www.lg.com/global/recycling.

INSTALLATION

Before Installation

Dimensions and Clearances

Too small of a distance from adjacent items may result in the degradation of freezing capability and increased electricity costs. Allow over 50 mm of clearance between the back of the appliance and the wall when installing the appliance.

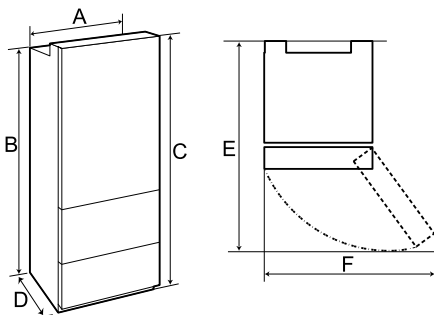

| Type | Dimensions |
|------|------------|
| A | 700 mm |
| B | 1753 mm |
| C | 1793 mm |
| D | 735 mm |
| E | 1350 mm |
| F | 1040 mm |

Ambient Temperature

- The appliance is designed to operate within a limited range of ambient temperatures, depending on the climate zone.
- The internal temperatures could be affected by the location of the appliance, the ambient temperature, the frequency of door opening and so on.
- The climate class can be found on the rating label.

| Climate Class | Ambient Temperature Range °C |
|-------------------------|--------------------------------------|
| SN (Extended Temperate) | +10 - +32 |
| N (Temperate) | +16 - +32 |
| ST (Subtropical) | +16 - +38 / +18 - +38** |
| T (Tropical) | +10 - +43* / +16 - +43 / +18 - +43** |

* Australia, India, Kenya

** Argentina

NOTE

- The appliances rated from SN to T are intended to be used at an ambient temperature between 10 °C and 43 °C.

Levelling the Appliance

Adjusting the Levelling Leg

If the appliance seems unsteady, or the doors do not close easily, adjust the appliance's tilt using the instructions below.

- 1 Open the bottom drawer and remove the cover from the appliance.

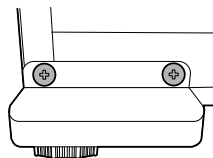

- 2 Turn the levelling leg to the left to raise that side of the appliance or to the right to lower it.

It may take several turns of the levelling leg to adjust the tilt of the appliance.

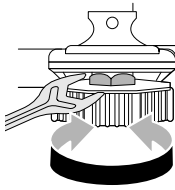

Moving the Appliance for Relocation

Moving the Appliance

- 1 Remove all food from inside the appliance.
- 2 Fix the power plug.
 - Models with a power plug hook:
 - Pull the power plug out, insert and fix it into the power plug hook at the rear or on top of the appliance.
 - Models without a power plug hook:
 - Pull the power plug out and fix the power supply cable with a tape to the side of the appliance where the power socket is located at the installation site.
- 3 Tape parts such as shelves and the door handle to prevent from falling off while moving the appliance.
- 4 Move the appliance with more than two people carefully. When transporting the appliance over a long distance, keep the appliance upright.

- 3 Open the door and the drawers and check to make sure that they close easily. If they do not close easily, tilt the appliance slightly more to the rear by turning both levelling legs to the left. It may take several more turns, and be sure to turn both levelling legs the same amount.

- 4 When the appliance is level, open the bottom drawer and reassemble the cover.

Turning on the Power

Connecting the Appliance

To turn on the appliance, connect the power plug into the outlet socket. Do not double up with other appliances on the same outlet.

NOTE

- After connecting the power supply cord (or plug) to the outlet, wait 3 or 4 hours before you put food into the appliance. If you add food before the appliance has cooled completely, your food may spoil.
- To turn off the appliance, disconnect the power plug from the outlet socket.

⚠ CAUTION

- Move the appliance carefully on sensitive floors to avoid damage to the floor.
 - Use cardboard, floor mat or carpet to prevent scratches on the floor when installing or moving the appliance.

⚠ CAUTION

- Do not move the appliance in zigzags.

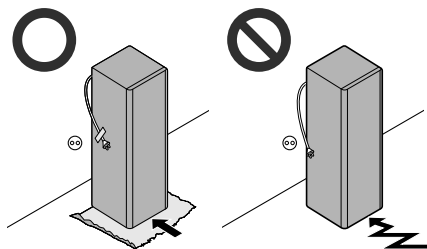

- 5** After installing the appliance, connect the power plug into a mains outlet socket and switch it on.

OPERATION

Before Use

Notes for Operation

- Before placing food in the appliance, clean the inside and outside of the appliance with warm water and a mild washing-up liquid to remove manufacturing residues.
- Users should keep in mind that frost can form if the door is not closed completely or if the humidity is high during the summer.
- Ensure there is sufficient space between food stored on the shelf or door basket to allow the door to close completely.
- Opening the door for long periods can cause a significant increase of the temperature in the compartments of the appliance.
- If the refrigerating appliance is left empty for long periods, switch off, defrost, clean, dry, and leave the door open to prevent mould developing within the appliance.
- Note that a temperature rise after defrosting has a permissible range in the appliance specifications. If you wish to minimise the impact on the food storage due to a temperature rise, seal or wrap the stored food in several layers.

Door Open Alarm

This feature is only available on some models.

The alarm sounds if the door is left open or not completely closed.

NOTE

- Contact the LG Electronics customer information centre if the alarm sound continues even after closing all doors.

Failure Detection

The appliance can automatically detect problems during the operation.

NOTE

- If a problem is detected, the appliance may not operate and an error code is displayed even when any button is pressed.
- If an error code is indicated on the display, do not turn off the power. Immediately contact the LG Electronics customer information centre and report the error code. If you turn off the power, the repair technician from the our information centre may have difficulty finding the problem.

Suggestion for Energy Saving

- For the most efficient use of energy, keep all inner parts (e.g. door bins, drawers and shelves) on their original location.
- Ensure there is sufficient space between stored foods. This allows cold air to be circulated evenly and lowers electricity bills.
- Store hot food only after it has cooled in order to prevent dew or frost.
- When storing food in the freezer compartment, set the freezer temperature lower than the temperature indicated on the food.
- Do not set the temperature of the appliance lower than needed.
- Do not put food near the temperature sensor of the fridge compartment. Keep a distance of at least 3 cm from the sensor.

Storing Foods Effectively

- Food may freeze or spoil if stored at the wrong temperature. Set the refrigerator to the correct temperature for the food being stored.
- Store frozen food or refrigerated food inside sealed containers.
- Check the expiration date and label (storage instructions) before storing food in the appliance.

18 OPERATION

- Do not store food for a long period of time if it spoils easily at a low temperature.
- Do not place unfrozen food in direct contact with food that is already frozen. Do not store excessive amounts of fresh food.
 - If you want to freeze food over several days, only store up to about 2/3 of the maximum freezing capacity.
- Freeze food in portion-sized quantities for faster freezing, easier thawing and processing.
- Place the refrigerated food or frozen food in each fridge or freezer compartment immediately after purchasing.
- Store raw meat and fish in suitable containers in the refrigerator, so that it is not in contact with or drip onto other food.
- Refrigerated foods and other food items can be stored on top of the vegetable drawer.
- Avoid refreezing any food which has been completely thawed. Freezing any food which has been completely thawed again will lower its taste and nutrition.
 - Only take out the amount of food that you need. Consume thawed food quickly. It can only be refrozen after being cooked.
- Cool hot food before storing. If too much hot food is placed inside, the internal temperature of the appliance can increase and negatively affect other foods stored in the appliance.
- Do not overfill the appliance. Cold air can not circulate properly if the appliance is overfilled.
- If you set an excessively low temperature for food, it may become frozen. Do not set a temperature lower than the required temperature for the food to be stored correctly.
- If there are chill compartments in the appliance, do not store vegetables and fruits with higher moisture content in the chill compartments as they may freeze due to the lower temperature.
- Always follow the food manufacturer's instructions on the permissible storage duration of frozen food. Do not exceed the recommended storage time of food.
 - Mark the storage date, permissible storage duration, and the food name on the packaging to prevent it from exceeding the storage time limit.
- In the event of a blackout, call the electricity company and ask how long it is going to last.
 - You should avoid door openings while the power is off.
 - When the power supply gets back to normal, check the condition of the food.
 - If the power outage lasts longer, especially during the summer months, please follow these guidelines:
 - Do not place additional food into the appliance during the power outage.
 - If the power outage is announced and is expected to last for more than 10 hours, prepare some ice and put it in a container on the top shelf of the fridge.
 - Due to the temperature increase in the appliance during a power outage or other malfunction, the shelf life of the food will be reduced and its quality will decrease. If necessary, process thawed food and freeze it again in the cooked state.

Freezing the Maximum Amount of Food

If large quantities of food are to be stored, the inner container and auto-lift device should be taken out of the bottom drawer.

CAUTION

- To remove the drawers, first remove the food from drawers and then pull out the drawers carefully. Not doing so could cause injury or damage to the drawers.
-

Product Features

The appearance or components of the appliance may differ from model to model.

Exterior

*1 This feature may vary depending on model purchased.

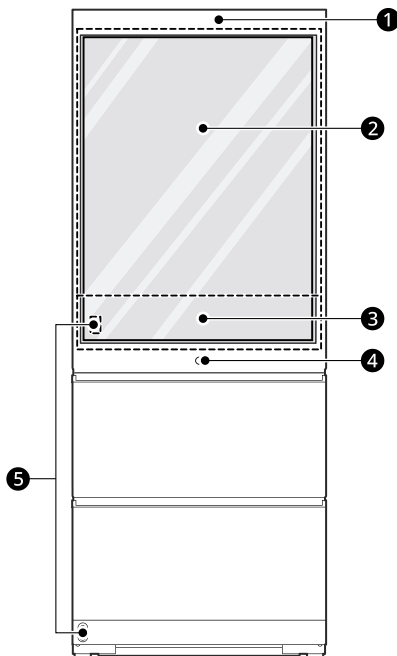

❶ Voice Assistant Device ^{*1}

A voice assistant device is built into the door.

❷ InstaView Door

The sleek tinted glass panel illuminates with two quick knocks, allowing you to see inside the easy access compartment without ever opening the door.

❸ Control Panel

Displays the wine, fridge, and freezer temperature controls.

❹ Bottom Pullout Drawer Button

When the button is pressed, the bottom drawer opens automatically and the inner compartment rises up for convenient access.

❺ Automatic Door Opening Sensors

Stand close enough to the front of the appliance and **DOOR OPEN** appears on the floor. Pass your foot over the words on the floor to open the wine storage door automatically.

Interior

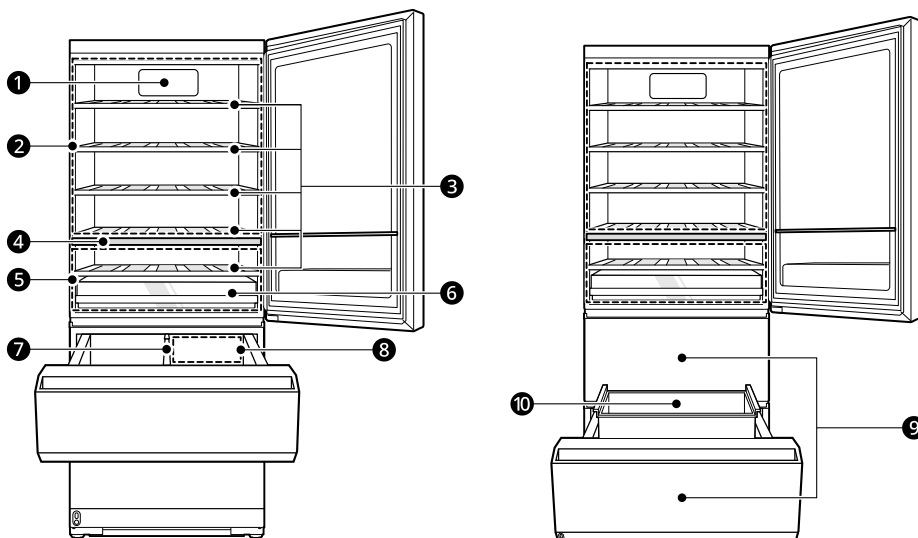

1 Fresh Filter

This reduces odours inside the wine compartment.

2 Upper Zone

Stores bottles of red wine.

3 Storage Rack

Stores wine bottles on their sides for best long-term storage.

4 Zone Divider

Helps maintain separate temperature zones.

5 Lower Zone

Stores bottles of white wine and champagne.

6 Champagne Drawer

Stores champagne bottles. Before storing champagne, turn on the champagne function in the control panel.

7 Durabase Divider

Provides storage for large food items.

8 Quick Freezing Zone

To freeze food items quickly, store the food in the right side of the middle drawer. Food items will freeze most quickly in the drawer.

9 Middle / Bottom Drawer

The 2 drawers can be set to either Fridge or Freezer mode. Both drawers must use the same mode.

- To store fresh food, press the **Fridge Drawer** button for at least 1 second.

- To store frozen food, press the **Freezer Drawer** button for at least 1 second.

CAUTION

- Empty out both drawers before changing the mode from freezer to fridge or vice versa.
 - If the mode is changed while food is in the drawer, the food could spoil.
-

Inner Container

This is where fruits and vegetables are stored to help maintain freshness by adjusting the humidity controller.

Control Panel

The actual control panel may differ from model to model.

Control Panel and Functions

*1 This feature may vary depending on model purchased.

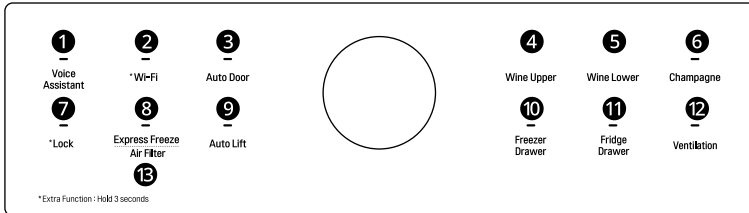

1 Voice Assistant*1

Changes voice assistant settings. This button allows you to activate/deactivate the Voice Assistant. To use the voice assistant feature, the appliance must be connected to the **LG ThinQ** application. For more information on connecting the appliance, refer to the **SMART FUNCTIONS**.

2 Wi-Fi

This button allows the appliance to connect to a home **Wi-Fi** network. Refer to **SMART FUNCTIONS** for information on the initial setup of the **LG ThinQ** application.

3 Auto Door

The door opens automatically if you place a foot near the motion sensor at the bottom of the door. This is convenient when you have both hands full and need to open the door.

To set the automatic opening door function, press the button repeatedly to toggle between the ON, Sound Off, and OFF settings.

4 Wine Upper

Indicates the set temperature of the upper zone in Celsius (°C). The default temperature is **13 °C**.

Press the **Wine Upper** button repeatedly to select a new set temperature from **11 °C to 18 °C**.

5 Wine Lower

Indicates the set temperature of the lower zone in Celsius (°C). The default temperature is **8 °C**.

Press the **Wine Lower** button repeatedly to select a new set temperature from **5 °C to 11 °C**.

6 Champagne

Press the **Champagne** button repeatedly to turn on and off this function. The default condition is turned off.

NOTE

- If you turn off this function, the temperature inside the champagne drawer remains the same as the temperature of the lower wine compartment.

7 Lock

The lock function disables every other button on the display.

- When power is initially connected to the appliance, the lock function is off.
- To lock the control panel buttons, press and hold the **Lock** button until the icon appears in the display and the function is activated.
- To disable the function, press and hold the **Lock** button for approximately three seconds.

8 Express Freeze

This function can quickly freeze a large amount of ice or frozen foods.

- This function is enabled and disabled in turn each time you press the button.
- This function automatically terminates after a specific period has passed.

9 Auto Lift

When **Auto Lift** is enabled, pressing the bottom pullout drawer button automatically opens the drawer and raises the inner compartment for convenient access.

Press the bottom pullout drawer button again to automatically lower the inner compartment and close the drawer.

10 Freezer Drawer

Press this button repeatedly to select a desired temperature between **- 23 °C and - 15 °C**.

- The default freezer temperature is **-18 °C**.
- To set the drawers to the freezer mode, press and hold the **Freezer Drawer** button for approximately 1 second.

11 Fridge Drawer

Press this button repeatedly to select a desired temperature between **1 °C and 7 °C**.

- The default fridge temperature is **3 °C**.
- To set the drawers to the fridge mode, press and hold the **Fridge Drawer** button for approximately 1 second.

NOTE

- The displayed temperature is the target temperature, and not the actual temperature of the appliance. The actual temperature depends on the food inside the appliance.

12 Ventilation

Press the **Ventilation** button to raise the humidity in all temperature zones.

13 Air Filter

Replace the air filter when the icon turns on. After replacing the air filter, press and hold the **Air Filter** button for three seconds to turn the icon light off. Replace the air filter approximately every six months.

NOTE

- For optimal food preservation, increasing or decreasing 1 °C from the default temperature is recommended for each compartment.
- The control panel will turn off automatically for energy saving.
- If there is any finger or skin contacts to the control panel while cleaning it, the button function may operate.

24 OPERATION

NOTE

- This appliance incorporates an earth connection for functional purposes only.
-

Automatic Opening Door

Using the Automatic Opening Door

- 1 When the automatic door opening function is enabled, text is displayed on the floor near the motion sensor.

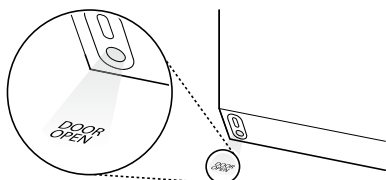

- 2 Pass one foot in front of the motion sensor and step on the displayed text. The door opens. If the door opens less than about 20 degrees and is not opened further, it will close automatically after 3 seconds. You must be standing directly in front of the appliance in close proximity for the door opening sensor to operate.

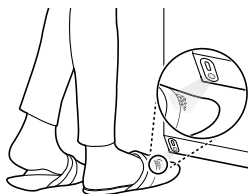

⚠ CAUTION

- You may want to disable the automatic door opening function if you have young children or persons with reduced physical, sensory, or mental capabilities in the home. They could be injured if the door opens unexpectedly while they are nearby.

NOTE

- Place your foot close enough to the sensor that the text appears on top of the foot, not just on the toes.



- The displayed text may not be readable on some flooring materials, but this will not affect the performance of the automatic door opening function.
- If flooring material is highly reflective (metal, glass tile), the motion sensor may malfunction and the automatic door opening function may not work properly.
- Reflective objects placed in front of the motion sensor may cause the text to display, but the text disappears if no movement is detected.
- If a pet passes by below when a person stands in front of the product, the automatic door opening function may be triggered.

InstaView

This feature is only available on some models.

Using the InstaView Door

The sleek tinted glass panel illuminates with two quick knocks, allowing you to see inside the wine storage compartment without ever opening the door.

- 1 Knock twice on the glass to turn the LED light inside the door on or off.
- 2 The LED light turns off automatically after ten seconds.

NOTE

- The InstaView Door function is disabled for 2 seconds after closing the door.

NOTE

- Knock near the center of the glass. Knocking near the edges of the glass may not activate the InstaView Door function.
- Knock hard enough so that the knocking sound is audible.
- The InstaView Door function may activate if a loud noise occurs near the appliance.
- Clean the glass door with a dry cloth. To remove stubborn stains, slightly moisten a clean cloth with lukewarm water or a glass cleaner. Do not spray glass cleaner directly at the glass door.

Storing Wine

⚠ CAUTION

- Do not overfill or pack items too tightly onto storage racks. Doing so may cause damage to the rack or personal injury if items are removed with excessive force.

NOTE

- If you are leaving home for a short period, like a short vacation, the appliance should be left on.
- If you are leaving the appliance turned off for an extended period, remove all contents and turn off the power. Clean the interior, and leave the door and drawers open or slightly ajar to prevent fungi from growing in the appliance.
- If the appliance is kept in a hot and humid place, frequent opening of the door may cause condensation to form. Wipe off the condensation with a clean cloth or a paper towel.
- If the wine compartment door is opened and closed too often, warm air may penetrate the appliance and raise its temperature. This can increase the running costs of the unit and shorten the storage life of stored wines.
- Do not install the wine cooler near heat sources or where it will be exposed to direct sunlight.

Storage Capacity

The wine storage compartment of this product is designed to store only wine, so it is not recommended for storing other liquor, beverages or foods.

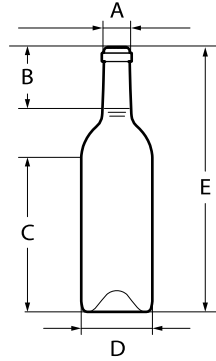

| List | Dimension (mm) |
|------|----------------|
| A | ∅ 27.5 |
| B | 63 |
| C | 158.5 |
| D | ∅ 76.1 |
| E | 300.5 |

NOTE

- Stagger the fronts and backs of the bottles on the racks for safer storage.

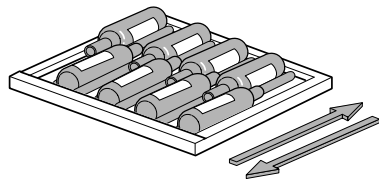

Storing Red Wine

The top shelf can hold up to 16 normally sized wine bottles. The remaining shelves can hold up to 9 normally sized wine bottles each.

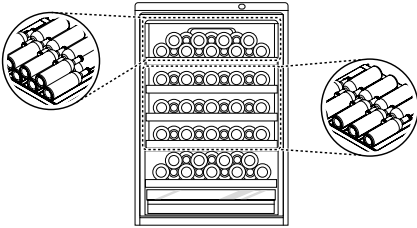

Storing White Wine

The shelf can hold up to 16 normally sized wine bottles.

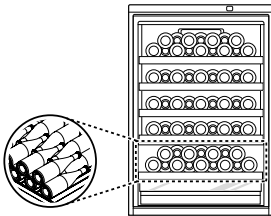

Storing Champagne

The drawer can hold up to 6 normally sized champagne.

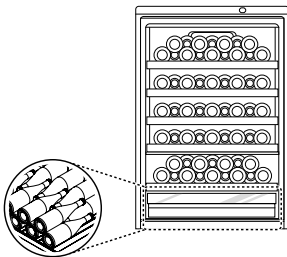

Storage Racks

The sliding racks help keep bottles organized and easy to reach.

⚠ CAUTION

- The storage racks are heavy. Always use two hands when removing or assembling the racks to avoid product damage or personal injury. Always empty racks before removing them.
- Always open the door completely before removing or assembling the racks.
- As a natural product, the wood used for the racks can vary in color and grain, including the presence of knots.
- Due to the nature of the wood, spilled wine and other liquids may stain or discolor the racks.

Removing/Refitting Red Wine Racks

- 1 To remove, raise the front of the shelf to disengage the shelf hooks, then lift the shelf from the back.

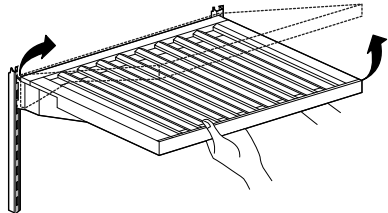

- 2 To refit, tilt the front of the shelf up and guide the shelf hooks into the slots at a desired height.

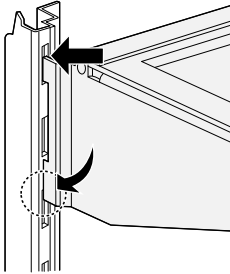

NOTE

- Foreign objects and dirt between the shelf and the inner cabinet wall could prevent the shelf light from turning on.

Removing/Refitting White Wine Rack

- 1 To remove the rack, lift the rack and pull straight out.

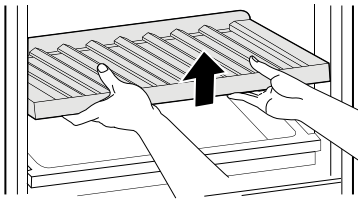

- 2 To refit the rack, insert the rack into the frame and lower it into place.

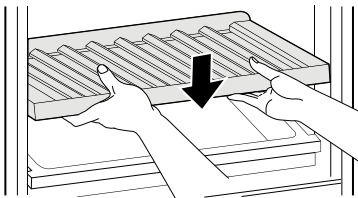

Removing/Refitting Champagne Drawer

- 1 To remove, pull the drawer 1 out.

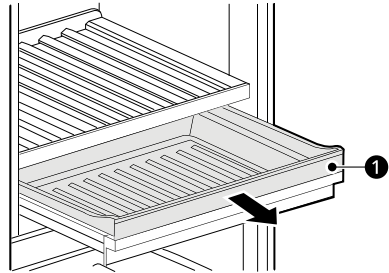

- 2 Lift the drawer straight up and out of the frame.

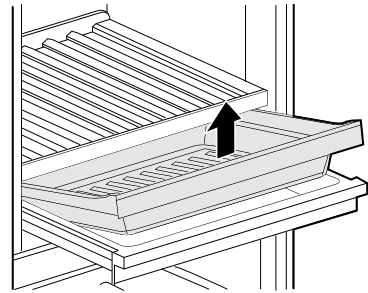

- 3 Keeping both levers 2 pressed, lift the drawer support slightly and remove it from the rail.

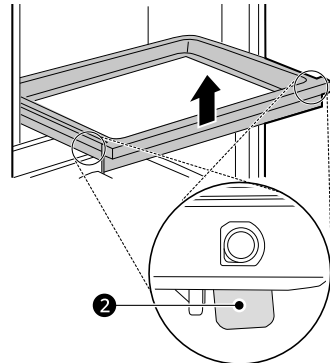

- 4 To refit, hook the drawer support on the rails located on both side and press it down until you hear snap sound.

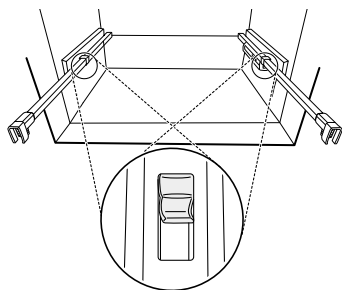

- 5 Angle the drawer into the frame and set it in place.

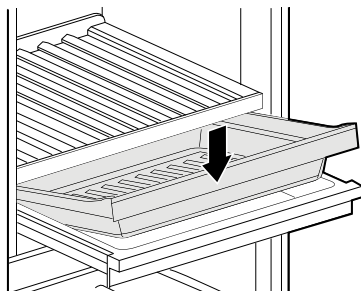

Shelf

Removing/Refitting the Shelf

- 1 Hold the both side of the shelf. Lift the shelf up and remove it by pulling it out.

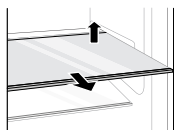

- 2 Refit the shelf by sliding it inward until the shelf snaps into the frame.

Auto-lift Device

Setting Auto Lift

Press **Auto Lift** repeatedly to toggle between Off → Sound On → Sound Off → Auto Drawer Opening Only.

The setting is indicated by the icon in the display.

- Off: The drawer must be opened manually and the auto-lift function is disabled.
- Sound On: Sound is heard, the drawer is automatically opened and the inner container is raised.
- Sound Off: The drawer automatically opens without sound and the inner container is raised.
- Auto Drawer Opening Only: The drawer opens automatically without sound, but the inner container is not raised.

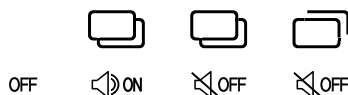

Using Auto Lift

- 1 Press the **Auto Lift** button to turn **Auto Lift** on.
- 2 Press the bottom pullout drawer button ②. The bottom drawer automatically opens and the inner container is raised.
 - When the auto open sensor ① detects motion in front of the appliance, the bottom pullout drawer button ② lights up. If the button does not light up, move closer to the appliance to trip the sensor.

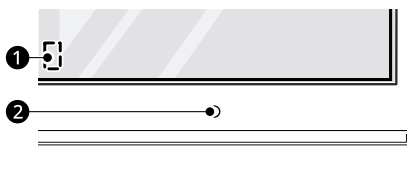

30 OPERATION

- 3 Press the bottom pullout drawer button  to automatically lower the inner container and close the drawer.

NOTE

- When the auto-lift function is turned off in the control panel:
 - Standing in front of the appliance will not activate the light around the bottom pullout drawer button.
 - When the bottom pullout drawer button is pressed, the light blinks 3 times.
- When the auto-lift function is turned on in the control panel:
 - If pressing the bottom pullout drawer button does not close the bottom drawer, open the middle drawer or manually close the bottom drawer.
 - If pressing the bottom pullout drawer button does not open the bottom drawer, manually opening the drawer will cause the inner compartment to lift up.
 - The auto-lift function does not work when the middle drawer is open.

- 2 Open the bottom drawer, hold the inner compartment with both hands and pull it out.

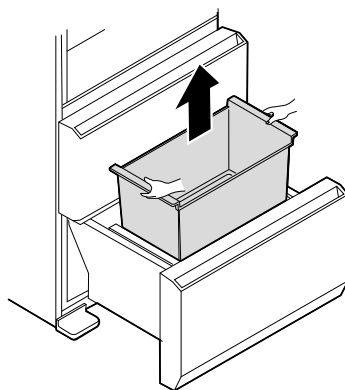

- 3 The auto-lift device is at the bottom of the drawer. Hold the inner edge of the device with both hands and pull it up.

Removing the Auto-lift Device

Remove the auto-lift device in the bottom drawer to increase the storage space or for cleaning.

- 1 Unplug the appliance or disconnect power.

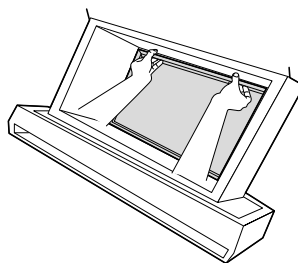

- 4 Hold the top of the auto-lift device with both hands and remove it from the bottom drawer.

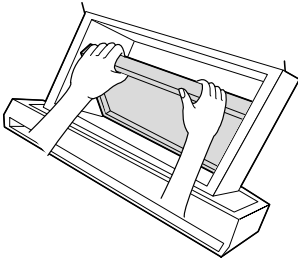

⚠ WARNING

- The auto-lift device is heavy, so remove it with both hands.

- 5 Insert the fingertips of both hands under the cover at the center and pull the cover forward gently.

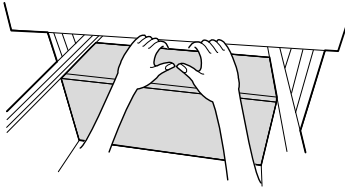

⚠ CAUTION

- Pull the cover gently to avoid damaging it.

- 6 Fold the back of the cover down and push the folded cover back slightly.

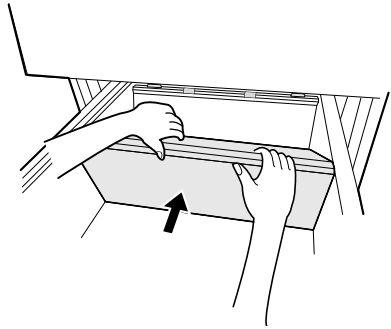

- 7 Insert the supplied hole cover into the groove at the bottom of the drawer.

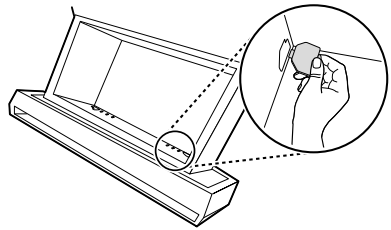

Refitting the Auto-lift Device

- 1 Remove the hole cover from the bottom of the drawer.

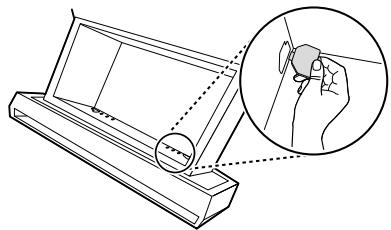

- 2** Raise the back section of the folded cover and rest it on the guide **1** at the rear of the drawer.

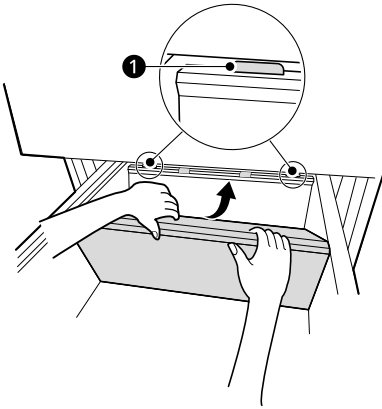

- 3** Hold the middle of the cover and lift it slightly into the groove.

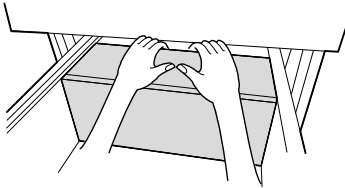

- 4** Make sure the hinges **2** on the auto-lift device are aligned with the slots **3** in the drawer.

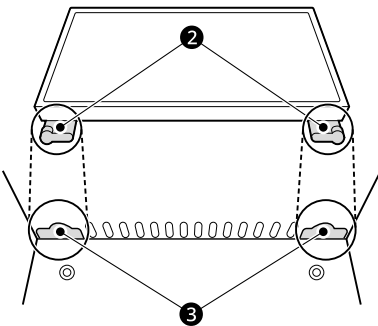

- 5** Lift the auto-lift device with both hands.

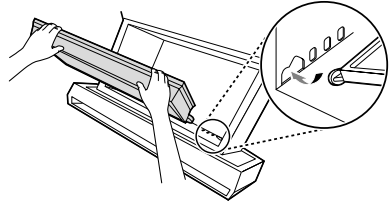

- 6** Insert the hinges on the auto-lift device into the slots at the front of the drawer.

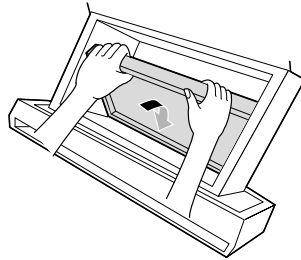

- 7** Lower the device into place and move it back and forth to make sure it is engaged.

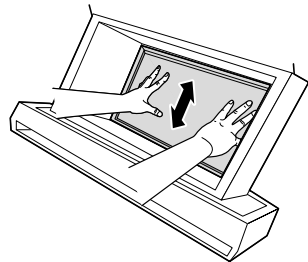

- 8** Use both hands to refit the inner compartment in the drawer.

- 9 Plug in the appliance or connect power.

SMART FUNCTIONS

LG ThinQ Application

This feature is only available on models with Wi-Fi. The **LG ThinQ** application allows you to communicate with the appliance using a smartphone.

LG ThinQ Application Features

Communicate with the appliance from a smartphone using the convenient smart features.

Smart Diagnosis

- If you experience a problem while using the appliance, this smart diagnosis feature will help you diagnose the problem.

Settings

- Allows you to set various options on the appliance and in the application.

NOTE

- If you change your wireless router, internet service provider, or password, delete the registered appliance from the **LG ThinQ** application and register it again.
- The application is subject to change for appliance improvement purposes without notice to users.
- Functions may vary by model.

Installing LG ThinQ Application and Connecting an LG Appliance

Models with QR Code

Scan the QR code attached to the product using the camera or a QR code reader application on your smartphone.

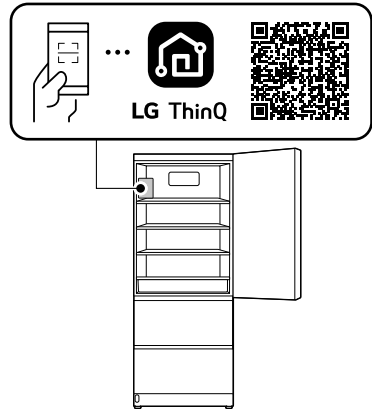

Models without QR Code

- 1 Search for and install the **LG ThinQ** application from the Google Play Store or Apple App Store on a smartphone.
- 2 Run the **LG ThinQ** application and sign in with your existing account or create an LG account to sign in.
- 3 Touch the add (+) button on the **LG ThinQ** application to connect your LG appliance. Follow the instructions in the application to complete the process.

NOTE

- To verify the Wi-Fi connection, check that the Wi-Fi indicator on the control panel is lit.

- The appliance supports 2.4 GHz Wi-Fi networks only. To check your network frequency, contact your Internet service provider or refer to your wireless router manual.
- **LG ThinQ** is not responsible for any network connection problems or any faults, malfunctions, or errors caused by network connection.
- The surrounding wireless environment can make the wireless network service run slowly.
- If the distance between the appliance and the wireless router is too far, the signal strength becomes weak. It may take a long time to connect or installation may fail.
- If the appliance is having trouble connecting to the Wi-Fi network, it may be too far from the router. Purchase a Wi-Fi repeater (range extender) to improve the Wi-Fi signal strength.
- The network connection may not work properly depending on the Internet service provider.
- The Wi-Fi connection may not connect or may be interrupted because of the home network environment.
- The appliance cannot be connected due to problems with the wireless signal transmission. Unplug the appliance and wait about a minute before trying again.
- If the firewall on your wireless router is enabled, disable the firewall or add an exception to it.
- The wireless network name (SSID) should be a combination of English letters and numbers. (Do not use special characters.)
- Smartphone user interface (UI) may vary depending on the mobile operating system (OS) and the manufacturer.
- If the security protocol of the router is set to **WEP**, you may fail to set up the network. Please change it to other security protocols (**WPA2** is recommended) and connect the product again.
- To disable the Wi-Fi function, press and hold the **Wi-Fi** button for 3 seconds. The Wi-Fi indicator will be turned off.
- To reconnect the appliance or add another user, press and hold the **Wi-Fi** button for 3 seconds to temporarily turn it off. Run the **LG ThinQ** application and follow the instructions in the application to connect the appliance.

Wireless LAN Module Specifications

| Model | PWFSA2 |
|---------------------|--------------------------|
| Frequency Range | 2412 - 2472 MHz |
| Output Power (Max.) | IEEE 802.11 b: 17.55 dBm |
| | IEEE 802.11 g: 16.07 dBm |
| | IEEE 802.11 n: 15.85 dBm |

Wireless function S/W version: V 1.0

For consideration of the user, this device should be installed and operated with a minimum distance of 20 cm between the device and the body.

Declaration of Conformity

UK Declaration of Conformity



Hereby, LG Electronics declares that the radio equipment type Refrigerator is in compliance with the relevant statutory requirements. The full text of the UK declaration of conformity is available at the following internet address:

<http://www.lg.com/global/support/cedoc/cedoc#>

EU Declaration of Conformity



Hereby, LG Electronics declares that the radio equipment type Refrigerator is in compliance with Directive 2014/53/EU. The full text of the EU declaration of conformity is available at the following internet address:

<http://www.lg.com/global/support/cedoc/cedoc#>

Open Source Software Notice Information

To obtain the source code that is contained in this product, under GPL, LGPL, MPL, and other open source licenses that have the obligation to disclose

source code, and to access all referred license terms, copyright notices and other relevant documents, please visit <https://opensource.lge.com>.

LG Electronics will also provide open source code to you on CD-ROM for a charge covering the cost of performing such distribution (such as the cost of media, shipping, and handling) upon email request to opensource@lge.com.

This offer is valid to anyone in receipt of this information for a period of three years after our last shipment of this product.

Using the Voice Assistant

This feature may vary depending on model purchased.

Before Using

The product must be connected to the **LG ThinQ** app in order to use the voice assistant feature.

For more information on connecting the product, refer to the **SMART FUNCTIONS** section.

NOTE

- Voice assistant supports English commands only, so it will not be responded to other than English language.

Voice Assistant Features

Use your voice to automatically open the door and get information such as the weather or time of day.

| Function | Command (example) |
|-------------|--|
| Open Door | Open the refrigerator door. |
| | Could you open the refrigerator door? |
| | Please open the refrigerator door. |
| Information | What day is it today? |
| | What time is it now? |

NOTE

- Voice assistant results may vary based on the volume of the user's voice, their intonation, and the ambient noise.
- For best results, keep background noise to a minimum and stand within 3 m of the appliance.
- On some models, the motion sensor works with the voice assistant to answer certain voice commands.

Setting up the Voice Assistant

You must wake the voice assistant up before it can assist you. You can select 2 different ways to do this.

Wake Zone + Wake Word mode

This mode allows you to use either motion sensor activation or voice activation.

- **Wake Zone:** Stand close enough to the front of the product and the voice assistant will wake automatically without the wake word.
- **Wake Word:** Stand within 3 m of the appliance and clearly say, "**Hi, LG**".

Wake Word mode

This mode allows you to use voice activation.

- **Wake Word:** Stand within 3 m of the appliance and clearly say, "**Hi, LG**".

OFF mode

This mode turns off the voice assistant.

Setting up the Voice Assistant on Paired Refrigerators

When two or more refrigerators with the voice assistant feature are paired, the refrigerators will respond to your voice command at the same time. To avoid this, set the voice assistant feature to **ON** in the control panel of the appliance for which you want to use voice controls. Set the voice assistant feature to **OFF** in the control panel of the appliance for which you don't want to use voice controls.

Using Wake Word

To use the Wake Word, stand within 3 m of the appliance.

- 1 To wake the voice assistant, say, "**Hi, LG**".
 - The voice assistant control window automatically displays "**Go ahead, I'm listening.**" and enters the ready mode.
- 2 Clearly issue your command.
 - Example: **Open the refrigerator door.**
 - If the voice assistant does not recognize the command, repeat it or try a different command.

Using Wake Zone

To use the Wake Zone, stand near the front of the appliance and the voice assistant will automatically wake and enter standby mode to receive voice commands.

- 1 Stand in front of the product and wait a moment.
 - The voice assistant control window automatically displays "**Go ahead, I'm listening.**" and enters the ready mode.
- 2 Clearly issue your command.
 - Example: **Open the refrigerator door.**

NOTE

- Voice assistant supports English commands only, so it will not respond to commands that are not in English.
- To issue a new voice command, say, "**Hi, LG**" or move away from the appliance and then move close again (within 1 m).
- If the voice command is not recognized, the voice assistant function exits the standby mode.

Smart Diagnosis

This feature is only available on some models. Use this feature to help you diagnose and solve problems with your appliance.

NOTE

- For reasons not attributable to LGE's negligence, the service may not operate due to external factors such as, but not limited to, Wi-Fi unavailability, Wi-Fi disconnection, local app store policy, or app unavailability.
- The feature may be subject to change without prior notice and may have a different form depending on where you are located.

Using LG ThinQ to Diagnose Issues

If you experience a problem with your Wi-Fi equipped appliance, it can transmit troubleshooting data to a smartphone using the **LG ThinQ** application.

- Launch the **LG ThinQ** application and select the **Smart Diagnosis** feature in the menu. Follow the instructions provided in the **LG ThinQ** application.

Using Audible Diagnosis to Diagnose Issues

Follow the instructions below to use the audible diagnosis method.

- Launch the **LG ThinQ** application and select the **Smart Diagnosis** feature in the menu. Follow the instructions for audible diagnosis provided in the **LG ThinQ** application.

- 1 Press the **Lock** button to activate the lock function.
 - If the display has been locked for over 5 minutes, you must deactivate the lock and then reactivate it.

- 2 Open the fridge door and then hold the phone on the upper right speaker hole.

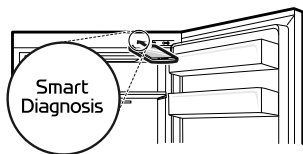

- 3 Press and hold the **Freezer Drawer** button for three seconds or longer while holding your phone to the speaker until the data transfer is complete.

- 4 After the data transfer is complete, the diagnosis will be displayed in the application.

NOTE

- For best results, do not move the phone while the tones are being transmitted.
-

MAINTENANCE

Cleaning

General Cleaning Tips

- Performing manual defrosting, maintenance or cleaning of the appliance while food is stored in the freezer can raise the temperature of the food and reduce its storage life.
- Regularly clean any surfaces that can come in contact with food.
- When cleaning the inside or outside of the appliance, do not wipe it with a rough brush, toothpaste, or flammable materials. Do not use cleaning agents containing flammable substances. This may cause discolouration or damage to the appliance.
 - Flammable substances: alcohol (ethanol, methanol, isopropyl alcohol, isobutyl alcohol, etc.), thinner, bleach, benzene, flammable liquid, abrasive, etc.
- After cleaning, check if the power cable is damaged.

Cleaning the Exterior

- When cleaning the outside air vents of the appliance by means of vacuuming, then the power cord should be unplugged from the outlet to avoid any static discharge that can damage the electronics or cause an electric shock. Regular cleaning of the rear and side ventilation covers is recommended to maintain reliable and economical operation of the unit.
- Keep the air vents on the exterior of the appliance clean. Blocked air vents can cause fire or appliance damage.
- For the appliance exterior, use a clean sponge or soft cloth and a mild detergent in warm water. Do not use abrasive or harsh cleaners. Dry thoroughly with a soft cloth. Do not use contaminated cloths when cleaning the stainless steel doors. Always use a dedicated cloth and wipe in the same direction as the grain. This helps reduce surface staining and tarnishing.

Cleaning the Interior

- Before removing a shelf or drawer from inside the appliance, remove all stored foods from the shelf or drawer to prevent injury or damage to the appliance. Otherwise, injury may occur due to the weight of stored foods.
- Detach the shelves and drawers and clean them with water and a mild detergent, and then dry them sufficiently, before replacing them.
- Regularly wipe the door gaskets with a wet soft towel.
- Door basket spills and stains should be cleaned as they can compromise storage ability of the basket and could even be damaged.
- Never clean the shelves or containers in the dishwasher. The parts may become deformed due to the heat.
- The automatic defrosting system in the appliance ensures that the compartment remains free of ice buildup under normal operating conditions. Users do not need to defrost it manually.

Air Filter

Replacing the Fresh Filter

- 1 Remove the cover of the Fresh Filter compartment. The cover can be easily separated by inserting the plastic rod into the groove on either side of the bottom of the compartment.

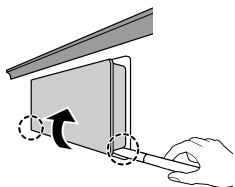

- 2 Remove the filter inside the Fresh filter cover and replace it with a new filter.
 - Make sure to insert the new filter with the “**Back**” label facing out.

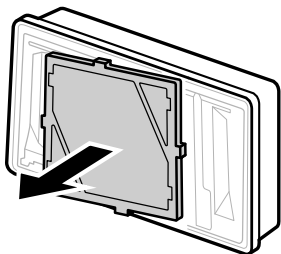

- 3 To reset the filter replacement period, press the **Air Filter** button on the control panel until the icon on the control panel turns off.

TROUBLESHOOTING

Before Calling for Service

Cooling

| Symptoms | Possible Cause & Solution |
|--|---|
| There is no refrigeration or freezing. | Is there a power interruption? <ul style="list-style-type: none"> Check the power of other appliances. |
| | Appliance is unplugged. <ul style="list-style-type: none"> Plug the power plug in the outlet properly. |
| | A fuse in your home may be blown or the circuit breaker tripped. Or the appliance is connected to a GFCI (Ground Fault Circuit Interrupter) outlet, and the outlet's circuit breaker has tripped. <ul style="list-style-type: none"> Check the main electrical box and replace the fuse or reset the circuit breaker. Do not increase fuse capacity. If the problem is a circuit overload, have it corrected by a qualified electrician. Reset the circuit breaker on the GFCI. If the problem persists, contact an electrician. |
| There is poor refrigeration or freezing. | Is the fridge or freezer temperature set to its warmest setting? <ul style="list-style-type: none"> Set the fridge or freezer temperature to a colder setting. |
| | Is the appliance in direct sunlight, or is it near a heat generating object such as cooking oven or heater? <ul style="list-style-type: none"> Check the installation area and reinstall it away from heat generating objects. |
| | Did you store hot food without cooling it first? <ul style="list-style-type: none"> Cool the hot food first before putting it in the fridge or freezer compartment. |
| | Did you put in too much food? <ul style="list-style-type: none"> Maintain an appropriate space between food. |
| | Are the appliance doors completely closed? <ul style="list-style-type: none"> Completely close the door and make sure that stored food is not obstructing in the door. |
| | Is there enough space around the appliance? <ul style="list-style-type: none"> Adjust the installation position to make enough space around the appliance. |
| The appliance contains a bad smell. | Is the fridge or freezer temperature set to 'Warm'? <ul style="list-style-type: none"> Set the fridge or freezer temperature to a colder setting. |

| Symptoms | Possible Cause & Solution |
|-------------------------------------|---|
| The appliance contains a bad smell. | Did you put in food with a strong smell? <ul style="list-style-type: none"> Store foods with strong smells in sealed containers. |
| | Vegetables or fruit may have spoiled in the drawer. <ul style="list-style-type: none"> Throw away rotten vegetables and clean the vegetable drawer. Do not store vegetables too long in the vegetable drawer. |

Condensation & Frost

| Symptoms | Possible Cause & Solution |
|--|---|
| There is condensation inside the appliance or on the bottom of the vegetable drawer cover. | Did you store hot food without cooling it first? <ul style="list-style-type: none"> Cool the hot food first before putting it inside the fridge or freezer. |
| | Did you leave the appliance door open? <ul style="list-style-type: none"> Although the condensation will disappear soon after you close the appliance door, you can wipe it with a dry cloth. |
| | Do you open the appliance doors too frequently? <ul style="list-style-type: none"> Condensation can form due to the temperature difference from the outside. Wipe out the dampness with a dry cloth and do not open the doors too frequently. |
| | Did you put warm or moist food inside without sealing it in a container? <ul style="list-style-type: none"> Store food in a covered or sealed container. |
| Frost has formed in the freezer compartment. | Doors may not be closed properly. <ul style="list-style-type: none"> Check if the food item inside the appliance is blocking the door and make sure that the door is tightly closed. |
| | Did you store hot food without cooling it first? <ul style="list-style-type: none"> Cool the hot food first before putting it in the fridge or freezer compartment. |
| | Is the air entry or exit of the freezer compartment blocked? <ul style="list-style-type: none"> Make sure that air entry or exit is not blocked so that the air can circulate inside. |
| | Is the freezer compartment overfilled? <ul style="list-style-type: none"> Maintain an appropriate space between items. |
| Frost or condensation has formed inside or outside the appliance. | Did you open and close the appliance door frequently or is the appliance door improperly closed? <ul style="list-style-type: none"> Frosts or condensation can form if the outside air penetrates inside the appliance. Do not open the doors too frequently. |

| Symptoms | Possible Cause & Solution |
|--|--|
| Frost or condensation has formed inside or outside the appliance. | <p>Is the installation environment humid?</p> <ul style="list-style-type: none"> Condensation can appear on the exterior of the appliance if the installation area is too humid or on a humid day such as a rainy day. Wipe off any moisture with a dry cloth. |
| The side or front of the appliance is warm. | <p>There are anti condensation pipes fitted to these areas of the appliance to reduce condensation forming from around the door area.</p> <ul style="list-style-type: none"> The heat releasing pipe to prevent condensation is installed on the front and side of the appliance. You may feel it particularly hot right after the appliance is installed or during the summer. You can be assured that this is not a problem and is quite normal. |
| There is water inside or outside of the appliance. | <p>Is there water leakage around the appliance?</p> <ul style="list-style-type: none"> Check if the water has leaked from a sink or another place. |
| | <p>Is there water on the bottom of the appliance?</p> <ul style="list-style-type: none"> Check if the water is from the thawed frozen food or a broken or dropped container. |

Parts & Features

| Symptoms | Possible Cause & Solution |
|---|---|
| The appliance door is not closed tightly. | <p>Is the appliance leaning forward?</p> <ul style="list-style-type: none"> Adjust the front feet to raise the front side slightly. |
| | <p>Were the shelves properly assembled?</p> <ul style="list-style-type: none"> Refit the shelves if needed. |
| | <p>Did you close the door with excessive force?</p> <ul style="list-style-type: none"> If you apply too much force or speed when closing the door, it may remain briefly open before closing. Make sure that you do not slam the door closed. Close without force. |
| It is difficult to open the appliance door. | <p>Did you open the door right after you closed it?</p> <ul style="list-style-type: none"> If you try to open the appliance door within one minute after you closed it, you may have difficulties because of the pressure inside the appliance. Try to open the appliance door again in a few minutes so that the internal pressure stabilizes. |
| The inside lamp in the appliance does not turn on. | <p>Lamp failure</p> <ul style="list-style-type: none"> Close the door and re-open. If the lamp does not turn on, please contact the LG Electronics customer information centre. Do not attempt removal of the lamp. |

Voice Assistant

| Symptoms | Possible Cause & Solution |
|--|---|
| Voice Assistant function turns on automatically. | <p>The voice assistant is set to the Wake Zone + Wake Wordmode. Every time you pass in front of the appliance, the voice assistant wakes and enters the standby mode to recognize voice commands.</p> <ul style="list-style-type: none"> Change Voice Assistant from Wake Zone + Wake Word to Wake Word. |

Noises

| Symptoms | Possible Cause & Solution |
|---|--|
| The appliance is noisy and generates abnormal sounds. | <p>Is the appliance installed on a weak floor or improperly levelled?</p> <ul style="list-style-type: none"> Install the appliance on a solid and flat area. |
| | <p>Does the rear of the appliance touch the wall?</p> <ul style="list-style-type: none"> Adjust the installation position to allow enough clearance around the appliance. |
| | <p>Are objects scattered behind the appliance?</p> <ul style="list-style-type: none"> Remove the scattered objects from behind the appliance. |
| | <p>Is there an object on top of the appliance?</p> <ul style="list-style-type: none"> Remove the object on top of the appliance. |
| Clicking noises | <p>The defrost control will click when the automatic defrost cycle begins and ends. The thermostat control (or appliance control on some models) will also click when cycling on and off.</p> <ul style="list-style-type: none"> Normal Operation |
| Rattling noises | <p>Appliance is not resting evenly on the floor.</p> <ul style="list-style-type: none"> Floor is weak or uneven or levelling legs need to be adjusted. |
| | <p>Appliance with a compressor was moved while operating.</p> <ul style="list-style-type: none"> Normal operation. If the compressor does not stop rattling after three minutes, turn the power to the appliance off and then on again. |
| Whooshing noises | <p>Evaporator fan motor is circulating air through the fridge and freezer compartments.</p> <ul style="list-style-type: none"> Normal Operation |
| | <p>Air is being forced over the condenser by the condenser fan.</p> <ul style="list-style-type: none"> Normal Operation |
| Gurgling noises | <p>Appliance flowing through the cooling system.</p> <ul style="list-style-type: none"> Normal Operation |

| Symptoms | Possible Cause & Solution |
|----------------|--|
| Popping noises | <p>Contraction and expansion of the inside walls due to changes in temperature.</p> <ul style="list-style-type: none"> • Normal Operation |
| Vibrating | <p>If the side or back of the appliance is touching a cabinet or wall, some of the normal vibrations may make an audible sound.</p> <ul style="list-style-type: none"> • To eliminate the noise, make sure that the sides and back do not make any contact with any wall or cabinet. |

Wi-Fi

| Symptoms | Possible Cause & Solution |
|--|--|
| Your home appliance and smartphone are not connected to the Wi-Fi network. | <p>The password for the Wi-Fi that you are trying to connect to is incorrect.</p> <ul style="list-style-type: none"> • Find the Wi-Fi network connected to your smartphone and remove it, then register your appliance on LG ThinQ. |
| | <p>Mobile data for your smartphone is turned on.</p> <ul style="list-style-type: none"> • Turn off the Mobile data of your smartphone and register the appliance using the Wi-Fi network. |
| | <p>The wireless network name (SSID) is set incorrectly.</p> <ul style="list-style-type: none"> • The wireless network name (SSID) should be a combination of English letters and numbers. (Do not use special characters.) |
| | <p>The router frequency is not 2.4 GHz.</p> <ul style="list-style-type: none"> • Only a 2.4 GHz router frequency is supported. Set the wireless router to 2.4 GHz and connect the appliance to the wireless router. To check the router frequency, check with your Internet service provider or the router manufacturer. |
| | <p>The distance between the appliance and the router is too far.</p> <ul style="list-style-type: none"> • If the distance between the appliance and the router is too far, the signal may be weak and the connection may not be configured correctly. Move the location of the router so that it is closer to the appliance. |

Customer Care and Service

Contact an LG Electronics customer information centre.

- To find information on LG authorized service centre, visit our website at www.lg.com.
- Only qualified service personnel from LG authorized service centre should disassemble, repair, or modify the appliance.
- The minimum warranty period of this refrigerating appliance is 24 months.
- Spare parts referenced in Regulation EU 2019/2019 are available for 7 years (only door gaskets are available for 10 years).

46 TROUBLESHOOTING

- To purchase spare parts, contact an LG Electronics customer information centre or our website at www.lg.com.

NOTE

- Regulation EU 2019/2019, valid from 1st March 2021, is related to the Energy Efficiency classes by Regulation EU 2019/2016.
- For more information about the energy efficiency of the appliance, visit <https://eprel.ec.europa.eu> and search using the model name (valid from 1st March 2021).
- Scan the QR code on the energy label supplied with the appliance, which provides a web link to the information related to the performance of the appliance in the EU EPREL database. Keep the energy label for reference and all other documents supplied with the appliance (valid from 1st March 2021).
- The model name can be found on the rating label of the appliance.
- This product contains a light source of energy efficiency class G.

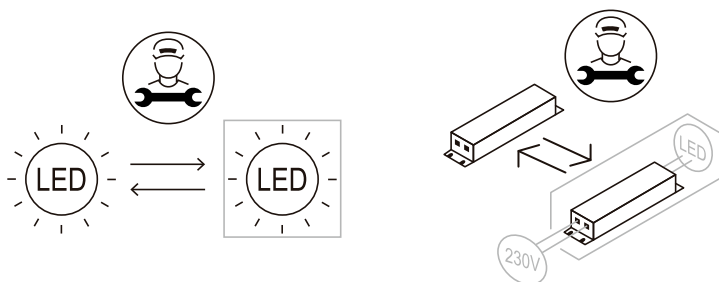

Memo

LG SIGNATURE