

# SPECIFICATIONS

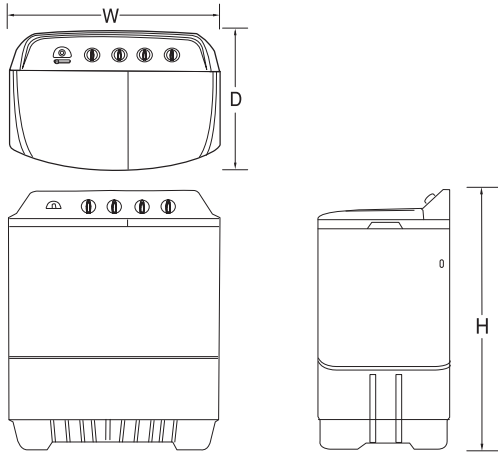

Power source	On specification label
Water Level	H : 84 Litres, M: 72 Litres, L : 60 Litres, S : 50 Litres
Water Pressure	Less than 100 kPa (1 kgf/cm <sup>2</sup> )
Dimension	880 x 530 x 1025 mm. (W x D x H)
Weight	30.0 kg



## OWNER'S MANUAL

# WASHING MACHINE



Before beginning installation, read these instructions carefully. This will simplify installation and ensure that the product is installed correctly and safely. Leave these instructions near the product after installation for future reference.

EN ENGLISH

WP12WGR



MFL39986142  
Rev.01\_021121

www.lg.com  
Copyright © 2019-2021 LG Electronics. All rights reserved.

8

## CAUTION

READ ALL SAFETY INFORMATION AND INSTALLATION INSTRUCTIONS BEFORE USE



Follow all instructions in this manual to minimize the risk of fire, electric shock and to prevent property damage, personal injury or loss of life.

### Installation

- Do not install in areas exposed to snow, rain or to the weather.
- Install the washing machine on a horizontal support. Otherwise it may cause vibration and noise.

### Switch Area

- Avoid watering on the switch area. It may cause electric shock or fire.

### Spin Motor

- After continuous using spinning program 3 times, please stop spinning more than 1 hour. Otherwise the spin motor could be damaged of fire.

### In Operation

- Do not put your hand into the spin dryer basket while the machine is in operation.
- Do not drain the water out of the wash tub while the spin dryer basket is in operation. Otherwise the spin motor could be damaged.
- If during spinning, opening the lid does not stop the spin dryer basket within about 15 sec., immediately unplug and contact service.

### Electric Outlet

- Avoid connecting several electric devices to single outlet. It may cause fire.

### Volatile Material

- Do not use volatile material such as Benzene, Gasoline, kerosene, Insecticide.
- Do not leave strong alkaline substance such as bleach inside the tub. Damage on plastic surface and rubber parts may occur.

### Hot water

- Avoid using hot water over 50°C. It may deform plastic parts or cause malfunction.

### Heat

- Avoid electric heater, candle light, cigarette light, bug smoker, etc. near the machine. It may ignite or deform plastic part.

### Power Cord and Plug

- Do not damage, bend, distort or place any heavy objects on its.
- If the supply cord is damaged, it must be replaced by the manufacturer or its service agent or a similarly qualified person.
- Wipe off dirt or dust on the contacts of the power plug. It may cause fire.
- Do not touch a power plug with a wet hand. It may cause electric shock.
- Unplug the supply cord when not using the washing machine for a long time.

- This appliance is not intended for use by persons (including children) with reduced physical, sensory or mental capabilities, or lack of experience and knowledge, unless they have been given supervision or instruction concerning use of the appliance by person responsible for their safety. Children should be supervised to ensure that they do not play with the appliance.

- Do not allow children to play on, with, or inside the washing machine.
- Do not step on the washing machine or place any heavy objects on it.
- Do not wash, rinse or spin dry the waterproof sheets and clothes.
- Connect the washing machine to a grounded outlet in accordance with all local codes and ordinances.
- Disconnect the power supply before cleaning or performing maintenance. Unplugging the power cord by grasping the plug with dry hands. Never grasp the cord.
- The units should not be repaired, disassembled or modified by any person except the authorized technicians.
- This product may only be sold in Asia, Middle East and African countries and complies with the regulatory requirements in these countries.
- This product may not be sold outside these territories. LG Electronics cannot guarantee and is not responsible for the compliance of this product with the regulatory requirements in other regions/countries.
- A precaution indicates that the washing machine shall not be installed at a humid place.
- A precaution on the washing machine whose lid can be opened during water extraction, that if it takes 15 s or more for complete stop of water-extracting chamber tub such a case should be understood as a trouble.
- This appliance is intended to be used in household and similar applications.

If this product is used for commercial purpose, it is not warranted.  
(Example : Public places such as public bathroom, lodging house, training center, dormitory)  
If the product is installed outside the normal service area, any cost of transportation involved in the repair of the product, or the replacement of a defective part, shall be borne by the owner.  
\*Remark : Avoid using hot water over 60°C. (Only for Saudi Arabia Country)

2

## FEATURES

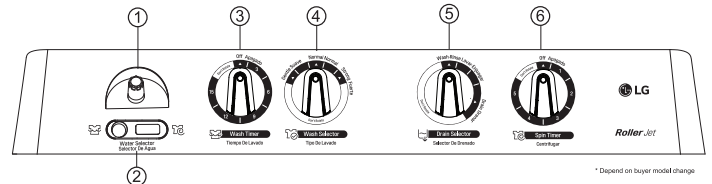
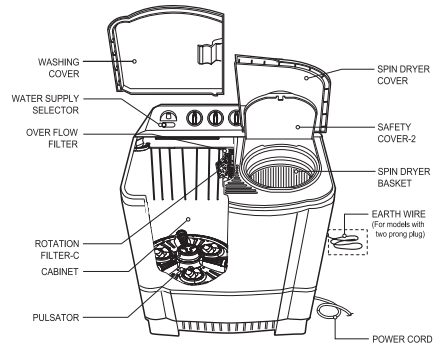

### 1. Water Supply Inlet

Connect here with the inlet hose from the water faucet to feed water to the tub.

### 2. Water Supply Selector

Select "WASH" to supply water for washing and rinsing and "SPIN" for spin shower rinse.

### 3. Wash Timer

Select the desired time for washing or rinsing. The maximum is 15 min.

### 4. Wash Selector

Set the program to "Gentle", "Normal", "Strong" according to kinds and quantity of the laundry.

### 5. Drain Selector

Select "Wash + Rinse" for washing and rinsing and "Drain" to drain the water out of the tub.

### 6. Spin Timer

Select the desired time for spinning. The maximum limit is 5 min. Don't rotate the knob more than prescribe limit.  
\*\*Stop spinning program for more than 1 hour after using spinning program 3 times continuously. Otherwise, the spin motor could be damaged of fire or stop operation.

3

# INSTALLATION

## Installation area

- Set on flat and firm floor.
- Incorrect installation may cause severe noise and break down.

- Maintain more than 10 cm. between the side of drain hose and the wall.
- A carpet must not obstruct the ventilation openings.

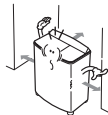

## Connecting the earth wire

- Install the earth wire to prevent short-circuit due to leaking current and electric shock.
- It is attached at the back of the washer. Connect it to the metal water pipe. If the water pipe is made of plastic, it does not have the earth effect.
- Do not connect the earth wire to the gas pipe, lightning arrester, telephone connector, etc..

\*Warning - the appliance with two pronged plug must be grounded.

## Connecting the power plug

- Insert the power plug into the outlet.
- Before connecting the power plug, check if the voltage setting of the washer matches the outlet voltage.
- If AC outlet with ground terminal is used, grounding is not needed. If not, never forget earthing.
- The appliance must be positioned so that the plug is accessible.

## Other earthing method

• After connecting the earth wire to the earth copper plate, bury it at least 75cm deep under the wet ground.

• Connecting to the earthing-only outlet.

• When installing it in an area where earthing is not possible, purchase a short-circuit breaker connect it to the outlet.

## Connecting the drain hose

- Connect the drain hose to the outlet of the plunger valve located at the back side.
- Push the clamp toward the body of the washing machine as shown in the figure.
- Be sure to reroute the hose so that it is not kinked, kinks or sharp bending in the hose will prevent proper drainage.
- Make sure water is drained smoothly by placing a base under the machine or by applying other appropriate mean.

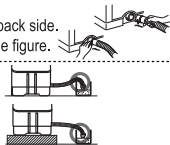

## Installation

- This appliance must be grounded. In the event of malfunction or breakdown, grounding will reduce the risk of electric shock by providing a path of least resistance for electric current.
- This appliance is equipped with a power cord having an equipment-grounding conductor and a grounding power plug. The power plug must be plugged into an appropriate socket outlet that is installed and grounded in accordance with all local codes and ordinances.
- Improper connection of the equipment-grounding conductor can result in risk of electric shock. Check with a qualified electrician or service personnel if you are in doubt as to whether the appliance is properly grounded.
- Do not modify the power cord provided with the appliance.
- The washing machine is to be connected to the water mains using new hose-sets and old hose-sets should not be reused.

4

# INSTALLATION & HOW TO WASH

## Before washing

1. Check the washing instruction labels on the clothing to be washed.
2. Remove all objects from the pockets of the clothing. Objects left in the pockets may damage clothing or break the washing machine (could cause the drain hose to clog).
3. After separating oiled or dyed clothing, wash.
4. For your convenience hang up the wash cover on the right or left side of the washing machine tub when not in use.

## Remove this before washing



## How to wash

**1** Set the drain selector Set as "Wash+Rinse" position.

**5** Select the wash program to "Gentle", "Normal" or "Strong" according to the kinds and quantity of the laundry. (Refer to Table 2)

**7** When washing is finished, locate the drain selector to "Drain" position and drain the water out.

**2** Set the water selector to "WASH"

**6** Set the desired wash time.

**8** Spinning in the spin dryer basket. Move the laundry into spin dryer basket. Put the laundry down lightly. Place the safety cover horizontally on the laundry. Set the desired spin time with the spin timer.

5

# HOW TO RINSE & HOW TO SPIN

## Interim spin rinse

- Interim spin rinse prior to regular rinsing helps removing sudsy water from the laundry and improve rinsing efficiency. Also is helpful to water saving.

**1** After washing. Move the laundry into the spin dryer basket. Place the safety cover horizontally on the laundry.

**2** Set the water selector to "SPIN".

**3** Set the desired spin flow appropriately. \*\*5 minutes maximum rotation in rinse. (See table 3)

**4** After interim spin rinse, move the laundry into the wash tub for rinsing.

## Note for spinning

1. Put the laundry evenly into the spin dryer basket.
2. Put the laundry down lightly.
3. Place the safety cover horizontally over the laundry, washing machine will be damage if the safety cover is not placed.
4. Close the spin dryer cover.
5. Do not drain the water out of the wash tub while the spin dryer basket is in operation.
6. If the spin dryer basket is off-balance and vibrates excessively, stop the spinning, rearrange the clothes evenly, and then resume spinning.

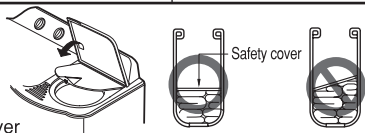

# CARE & MAINTENANCE

## Overflow filter & Rotation filter-C

1. Lift up the area (A) of the over flow filter and take out the rotation filter-C by pulling in direction as shown.
2. Pull the overflow filter forward from the wash tub in the direction of the arrow.
3. Turn the net over and rinse in water.
4. Use a brush or hand to remove all of the lint which has adhered to the overflow filter.
5. Insert the overflow filter back into the wash tub.
6. Insert the rotation filter-C back into the overflow filter.

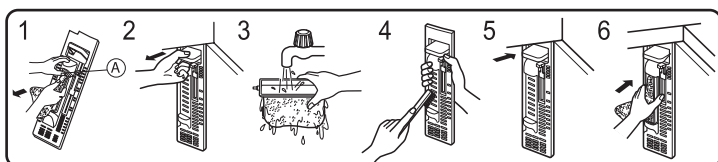

6

# REFERENCE

TABLE 1. WEIGHT GUIDE FOR CLOTHES

Type of clothing	Type of fabric	Weight per piece
Under shirt	Cotton	150g( 5.3oz)
Handkerchief	Cotton	50g( 1.8oz)
Bath towel	Cotton	300g(10.6oz)
Shirt	Mixed fabric	200g( 7.1oz)
Socks (1 pair)	Mixed fabric	50g( 1.8oz)
Pajamas (shirt and pants)	Cotton	500g(17.6oz)
Winter undershirt	Cotton	600g(21.2oz)
Workclothes	Mixed fabric	800g(28.2oz)
Blouse	Mixed fabric	200g( 7.1oz)

TABLE 2. GUIDE FOR WASHING

Type of fabric	Wash Selector	Wash time	Water level	Amount of laundry (Kg)	Amount of water (l)	Amount of detergent (g)
Synthetics, Silk, Woolen, Knits	Gentle	2-5 min	S	0.5 ~ 5.0	50	50
			L	5.0 ~ 6.0	60	60
			M	6.0 ~ 7.0	72	72
			H	7.0 ~	84	84
Cotton, Linen	Normal	5-10 min	S	0.5 ~ 5.0	50	50
			L	5.0 ~ 6.0	60	60
			M	6.0 ~ 7.0	72	72
			H	7.0 ~	84	84
Very soiled cotton and linen	Strong	10-15 min	S	0.5 ~ 5.0	50	50
			L	5.0 ~ 6.0	60	60
			M	6.0 ~ 7.0	72	72
			H	7.0 ~	84	84

- Amount of laundry is based on dry laundry.
- Detergent amount is based on a general synthetic detergent.
- If washing and spinning must be operated together, starting washing and spinning operation shall be done at the same time to cope with EMC requirement.

# TROUBLESHOOTING GUIDE

## Before Requesting Service

Problem	Checking point
Motor does not operate,	<ul style="list-style-type: none"> <li>• Is the power cord firmly plugged in?</li> <li>• Is the timer turned to a suitable point except "Off" ?</li> </ul>
Spin dryer basket does not operate.	<ul style="list-style-type: none"> <li>• Is there any clothing dropped between the basket and tub?</li> <li>• Is the spin dryer cover closed?</li> <li>• Is the laundry gathered to one side of the spin dryer basket?</li> </ul>
No draining	<ul style="list-style-type: none"> <li>• Is there lint stuck in the plunger valve?</li> <li>• Is the end of the drain hose guide located at an exceed height?</li> </ul>

7