

INSTALLATION MANUAL

AIR CONDITIONER

Please read this installation manual completely before installing the product.
Installation work must be performed in accordance with the national wiring standards by authorized personnel only.
Please retain this installation manual for future reference after reading it thoroughly.
※ This product contains Fluorinated Greenhouse Gases. (R410A)

MULTI

Original instruction

[Representative] LG Electronics Inc. EU Representative : LG Electronics European Shared Service Center B.V.
Krijgsman 1, 1186 DM Amstelveen, The Netherlands

[Manufacturer] LG Electronics Inc. Changwon 2nd factory 84, Wanam-ro, Seongsan-gu, Changwon-si,
Gyeongsangnam-do, KOREA

For more information, Refer to the CD or LG Web site (www.lg.com).



P/NO : MFL67855417

www.lg.com

ENGLISH

ITALIANO

ESPAÑOL

FRANÇAIS

DEUTSCH

ΕΛΛΗΝΙΚΑ

ČEŠTINA

NETHERLANDS

POLSKI

LIMBA ROMÂNĂ

TIPS FOR SAVING ENERGY

Here are some tips that will help you minimize the power consumption when you use the air conditioner. You can use your air conditioner more efficiently by referring to the instructions below:

- Do not cool excessively indoors. This may be harmful to your health and may consume more electricity.
- Block sunlight with blinds or curtains while you are operating the air conditioner.
- Keep doors or windows closed tightly while you are operating the air conditioner.
- Adjust the direction of the air flow vertically or horizontally to circulate indoor air.
- Speed up the fan to cool or warm indoor air quickly, in a short period of time.
- Open windows regularly for ventilation as the indoor air quality may deteriorate if the air conditioner is used for many hours.
- Clean the air filter once every 2 weeks. Dust and impurities collected in the air filter may block the air flow or weaken the cooling / dehumidifying functions.

For your records

Staple your receipt to this page in case you need it to prove the date of purchase or for warranty purposes. Write the model number and the serial number here:

Model number : _____

Serial number : _____

You can find them labeled on the side of each unit.

Dealer's name : _____

Date of purchase : _____

IMPORTANT SAFETY INSTRUCTIONS

READ ALL INSTRUCTIONS BEFORE USING THE APPLIANCE.

Always comply with the following precautions to avoid dangerous situations and ensure peak performance of your product

⚠ WARNING

It can result in serious injury or death when the directions are ignored

⚠ CAUTION

It can result in minor injury or product damage when the directions are ignored

⚠ WARNING

- Installation or repairs made by unqualified persons can result in hazards to you and others.
- Installation work must be performed in accordance with the National Electric Code by qualified and authorized personnel only.
- The information contained in the manual is intended for use by a qualified service technician familiar with safety procedures and equipped with the proper tools and test instruments.
- Failure to carefully read and follow all instructions in this manual can result in equipment malfunction, property damage, personal injury and/or death.

Installation

- Do not use a defective or underrated circuit breaker. Use the correctly rated breaker and fuse. There is risk of fire or electric shock.
- For electrical work, contact the dealer, seller, a qualified electrician, or an Authorized Service Center. Do not disassemble or repair the product by yourself. There is risk of fire or electric shock.
- Always ground the product as per the wiring diagram. Do not connect the ground wire to gas or water pipes lightning rod or telephone ground wire. There is risk of fire or electric shock.
- Install the panel and the cover of control box securely. There is risk of fire or electric shock due to dust , water etc.
- Use the correctly rated breaker or fuse. There is risk of fire or electric shock.

- Do not modify or extend the power cable. If the power cable or cord has scratches or skin peeled off or deteriorated then it must be replaced. There is risk of fire or electric shock.
- For installation, removal or reinstall, always contact the dealer or an Authorized Service Center. There is risk of fire, electric shock, explosion, or injury.
- Do not install the product on a defective installation stand. Be sure that the installation area does not deteriorate with age. It may cause product to fall.
- Never install the outdoor unit on a moving base or a place from where it can fall down.
The falling outdoor unit can cause damage or injury or even death of a person.
- In outdoor unit the step-up capacitor supplies high voltage electricity to the electrical components. Be sure to discharge the capacitor completely before conducting the repair work.
An charged capacitor can cause electrical shock.
- When installing the unit, use the installation kit provided with the product. Otherwise the unit may fall and cause severe injury.
- Indoor/outdoor wiring connections must be secured tightly and the cable should be routed properly so that there is no force pulling the cable from the connection terminals. Improper or loose connections can cause heat generation or fire.
- Safely dispose off the packing materials. Like screws, nails, batteries, broken things etc after installation or svc and then tear away and throw away the plastic packaging bags. Children may play with them and cause injury.
- Be sure to check the refrigerant to be used. Please read the label on the product. Incorrect refrigerant used can prevent the normal operation of the unit.

Operation

- When the product is soaked (flooded or submerged) in water, contact an Authorized Service Center for repair before using it again.
There is risk of fire or electric shock.
- Be sure to use only those parts which are listed in the svc parts list. Never attempt to modify the equipment. The use of inappropriate parts can cause an electrical shock, excessive heat generation or fire.

- Do not touch , operate, or repair the product with wet hands. Hold the plug by hand when taking out. There is risk of electric shock or fire.
- Do not place a heater or other heating appliances near the power cable. There is risk of fire and electric shock.
- Do not allow water to run into electric parts. Install the unit away from water sources. There is risk of fire, failure of the product, or electric shock.
- Do not store or use or even allow flammable gas or combustibles near the product. There is risk of fire.
- Do not use the product in a tightly closed space for a long time. Perform ventilation regularly. Oxygen deficiency could occur and hence harm your health.
- Do not open the front grille of the product during operation. (Do not touch the electrostatic filter, if the unit is so equipped.) There is risk of physical injury, electric shock, or product failure.
- If strange sound, smell or smoke comes from product. Immediately turn the breaker off or disconnect the power supply cable. There is risk of electric shock or fire.
- Ventilate the product room from time to time when operating it together with a stove, or heating element etc. Oxygen deficiency can occur and hence harm your health.
- When the product is not to be used for a long time, disconnect the power supply plug or turn off the breaker. There is risk of product damage or failure, or unintended operation.
- Take care to ensure that nobody especially kids could step on or fall onto the outdoor unit. This could result in personal injury and product damage.
- Take care to ensure that power cable could not be pulled out or damaged during operation. There is risk of fire or electric shock.
- Do not place ANYTHING on the power cable. There is risk of fire or electric shock.
- When flammable gas leaks, turn off the gas and open a window for ventilation before turning on the product. Do not use the telephone or turn switches on or off. There is risk of explosion or fire.

 **CAUTION****Installation**

- Two or more people must lift and transport the product. Avoid personal injury.
- Do not install the product where it will be exposed to sea wind (salt spray) directly. It may cause corrosion on the product.
- Install the drain hose to ensure that the condensed water is drained away properly. A bad connection may cause water leakage.
- Keep level even when installing the product. To avoid vibration or noise.
- Do not install the product where the noise or hot air from the outdoor unit could damage or disturb the neighborhoods. It may cause a problem for your neighbors and hence dispute.
- Always check for gas (refrigerant) leakage after installation or repair of product. Low refrigerant levels may cause failure of product.
- Please install safely at a place that can sufficiently endure the weight of the product.
If the strength is not sufficient, the product may fall and cause injury.

Operation

- Do not use the product for special purposes, such as preserving foods, works of art, etc. It is a consumer air conditioner, not a precision refrigeration system. There is risk of damage or loss of property.
- Do not block the inlet or outlet of air flow. It may cause product failure.
- Use a soft cloth to clean. Do not use harsh detergents, solvents or splashing water etc. There is risk of fire, electric shock, or damage to the plastic parts of the product.
- Do not touch the metal parts of the product when removing the air filter. There is risk of personal injury.
- Do not step on or put anything on the product. (outdoor units) There is risk of personal injury and failure of product.
- Always insert the filter securely after cleaning. Clean the filter every two weeks or more often if necessary. A dirty filter reduces the efficiency.
- Do not insert hands or other objects through the air inlet or outlet while the product is operating. There are sharp and moving parts that could cause personal injury.

- Be cautious when unpacking and installing the product. Sharp edges could cause injury.
- If the refrigerant gas leaks during the repair, do not touch the leaking refrigerant gas. The refrigerant gas can cause frostbite (cold burn).
- Do not tilt the unit when removing or uninstalling it. The condensed water inside can spill.
- Do not mix air or gas other than the specified refrigerant used in the system. If air enters the refrigerant system, an excessively high pressure results, causing equipment damage or injury.
- If the refrigerant gas leaks during the installation, ventilate the area immediately. Otherwise it can be harmful for your health.
- Dismantling the unit, treatment of the refrigerant oil and eventual parts should be done in accordance with local and national standards.
- Replace the all batteries in the remote control with new ones of the same type. Do not mix old and new batteries or different types of batteries. There is risk of fire or product failure.
- Do not recharge or disassemble the batteries. Do not dispose of batteries in a fire. They may burn or explode.
- If the liquid from the batteries gets onto your skin or clothes, wash it well with clean water. Do not use the remote if the batteries have leaked. The chemicals in batteries could cause burns or other health hazards.
- If you eat the liquid from the batteries, brush your teeth and see doctor. Do not use the remote if the batteries have leaked. The chemicals in batteries could cause burns or other health hazards.
- Do not let the air conditioner run for a long time when the humidity is very high and a door or a window is left open. Moisture may condense and wet or damage furniture.
- Do not expose your skin or kids or plants to the cool or hot air draft. This could harm to your health.
- Do not drink the water drained from the product. It is not sanitary and could cause serious health issues.
- Use a firm stool or ladder when cleaning, maintaining or repairing the product at an height. Be careful and avoid personal injury.

TABLE OF CONTENTS

2 TIPS FOR SAVING ENERGY

3 IMPORTANT SAFETY INSTRUCTIONS

9 INSTALLATION

10 INSTALLATION OF INDOOR, OUTDOOR UNIT

- 10 Select the best location
- 11 Fixing Installation Plate
- 12 Piping length and elevation
- 13 Refrigerant charge
- 14 Preparing work for Installation (ART COOL Type Only)
- 15 Sticking the installation guide map and fixing Indoor unit (ART COOL Type Only)
- 16 Drill a hole in the wall

17 INSTALLATION OF WIRED REMOTE CONTROLLER

- 19 Wired remote controller installation

20 FLARING WORK AND CONNECTION OF PIPING

- 20 Flaring work
- 21 Connection of piping - Indoor
- 23 Connection of piping - Outdoor
- 26 Installation
- 27 Installation of The Main Unit

28 CONNECTING THE CABLE BETWEEN INDOOR UNIT AND OUTDOOR UNIT

- 28 Connect the cable to the Indoor unit
- 30 Connect the cable to the Outdoor unit
- 32 Connection of Wiring

33 CHECKING THE DRAINAGE AND FORMING THE PIPINGS

- 33 Checking the Drainage
- 34 Forming the Piping

35 AIR PURGING AND EVACUATION

- 35 Checking method
- 36 Evacuation

37 PANEL FRONT ASSEMBLY (ART COOL TYPE ONLY)

38 INSTALLATION PI485

39 TEST RUNNING

40 FUNCTION

- 40 Dip S/W Setting
- 41 Forced Cooling Operation
- 42 Wiring Error Check
- 42 Saving Power Consumption
- 43 Night Quiet Mode
- 44 Mode Lock
- 45 PCB Display(14/16/18/21k Model Only)

46 MAX COMBINATION CAPACITY







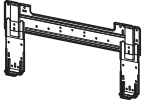
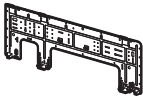
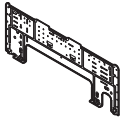
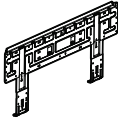

47 INSTALLATION GUIDE AT THE SEASIDE

47 SEASONAL WIND AND CAUTIONS IN WINTER













- 48 Model Designation
- 48 Airborne Noise Emission
- 48 Limiting concentration

INSTALLATION

Installation Parts

Installation plate				
				
Type "B" screws				
				
Type "A" screw (6 EA)	Type "A" screw (8 EA)	Type "A" screw (7 EA)	Type "A" screw and plastic anchors	
				
Holder Remote Control				
				

Installation Tools

Figure	Name	Figure	Name
	Screw driver		Multi-meter
	Electric drill		Hexagonal wrench
	Measuring tape, Knife		Ammeter
	Hole core drill		Gas-leak detector
	Spanner		Thermometer, Level
	Torque wrench		Flaring tool set

INSTALLATION OF INDOOR, OUTDOOR UNIT

Read completely, then follow step by step.

You need to select adequate installation location considering the following conditions, and make sure to acquire the consent of the user.

Select the best location

Indoor unit

- 1 Do not have any heat or steam near the unit.
- 2 Select a place where there are no obstacles in front of the unit.
- 3 Make sure that condensation drainage can be conveniently routed away.
- 4 Do not install near a doorway.
- 5 Ensure the spaces indicated by arrows from the wall, ceiling, fence or other obstacles.
- 6 Use a stud finder to locate studs to prevent unnecessary damage to the wall.

CAUTION

Install the indoor unit on the wall where the height from the floors more than 2.3 meters. (ART COOL Type Only 1.5m)

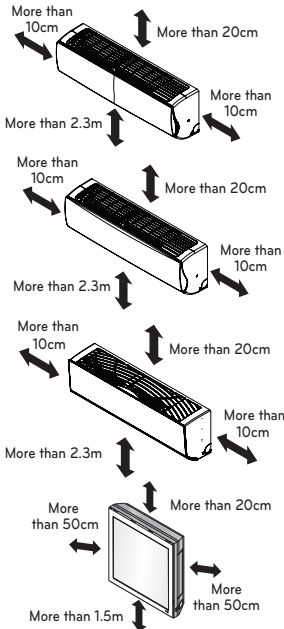

Outdoor unit

- 1 If an awning is built over the unit to prevent direct sunlight or rain exposure, make sure that heat radiation from the condenser is not restricted.
- 2 Ensure that the spaces indicated by arrows around front, back and side of the unit.
- 3 Do not place animals and plants in the path of the warm air.
- 4 Take the air conditioner weight into account and select a place where noise and vibration are minimum.
- 5 Select a place so that the warm air and noise from the air conditioner do not disturb neighbors.
- 6 Place that can sufficiently endure the weight and vibration of the outdoor unit and where even installation is possible
- 7 Place that has no direct influence of snow or rain
- 8 Place with no danger of snowfall or icicle drop
- 9 Place without weak floor or base such as decrepit part of the building or with a lot of snow accumulation

Rooftop Installations

If the outdoor unit is installed on a roof structure, be sure to level the unit. Ensure the roof structure and anchoring method are adequate for the unit location. Consult local codes regarding rooftop mounting.

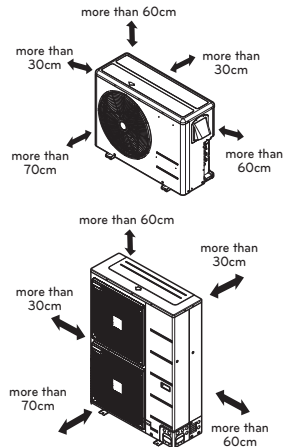

Fixing Installation Plate

The wall you select should be strong and solid enough to prevent vibration

- Mount the installation plate on the wall with type "A" screws. If mounting the unit on a concrete wall, use anchor bolts.
 - Mount the installation plate horizontally by aligning the centerline using a level.

<Type 1>

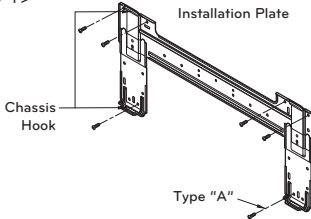

- Measure the wall and mark the centerline. It is also important to use caution concerning the location of the installation plate—routing of the wiring to power outlets is through the walls typically. Drilling the hole through the wall for piping connections must be done safely.

<Type 2>

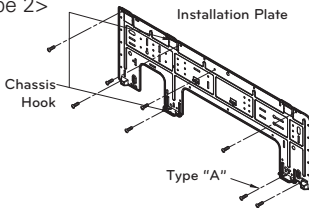

<Type 3>

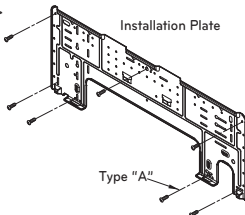

<Type 4>

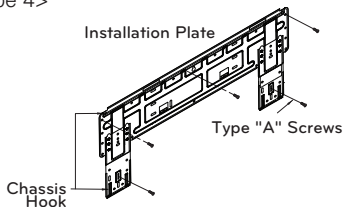

Indoor Type	Capacity (kBtu/h)	Type
Wall mounted /ART COOL Mirror	7, 9, 12	1, 3
	18, 24	2, 4

<Type 1>

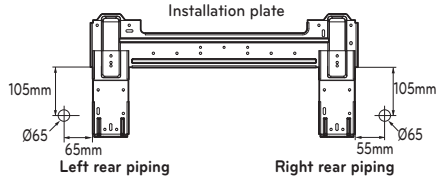

<Type 2>

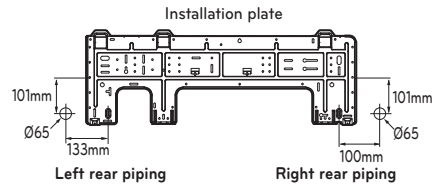

<Type 3>

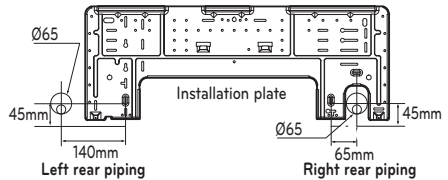

<Type 4>

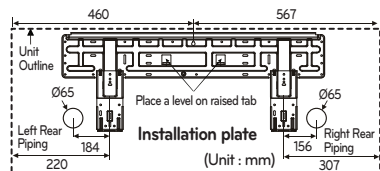

Piping length and elevation

Multiple Piping Models

(Unit: m)

Phase	Capacity(kBtu/h)	Total Length	Max Length(A/B)	Max Elevation (h1)	In - In Elevation (h2)
1Ø	14/16	30	20	15	7.5
	18	50	25	15	7.5
	21	50	25	15	7.5
	24/27	70	25	15	7.5
	30	75	25	15	7.5
	40	85	25	15	7.5

Distributor type Models

(Unit: m)

Phase	Capacity (kBtu/h)	Total Length	Max Main Pipe Length (A/B)	Total Branch Pipe Length	Max Branch Pipe Length	Max Elevation (h1)	In - In Elevation (h2)
1Ø	40	100	50	50	15	30	15
	48	135	55	80	15	30	15
	56	145	55	90	15	30	15
3Ø	42	125	55	70	15	30	15
	48	135	55	80	15	30	15
	56	145	55	90	15	30	15

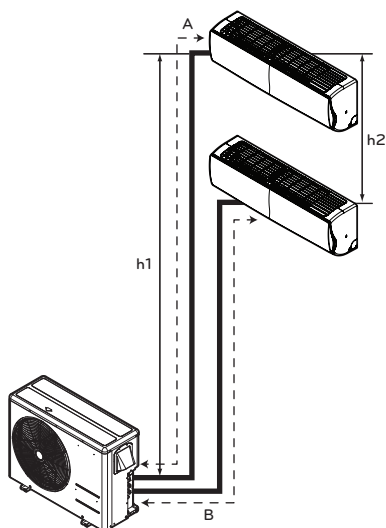

Multiple Piping Type

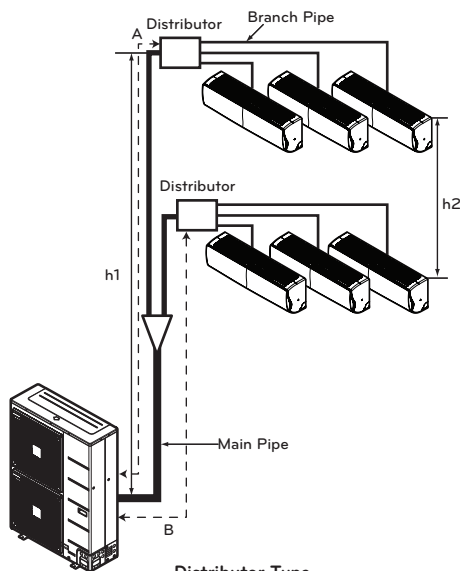

Distributor Type

CAUTION

Capacity is based on standard length and maximum allowance length is on the basis of reliability. If outdoor unit is at higher elevation than the indoor units, after 24m of vertical height, 1 oil trap is required.

Refrigerant charge

The calculation of the additional charge should be taken in account for the length of extra pipe.

Multiple Piping Models

(Unit: m)

Phase	Capacity(kBtu/h)	Standard Length(m)	Max Piping for one room(m)	Max total Piping Length	Additional Charge(g/m)
1Ø	14/16	7.5	20	30	20
	18	7.5	25	50	20
	21	7.5	25	50	20
	24/27	7.5	25	70	20
	30	7.5	25	75	20
	40	7.5	25	85	20

Distributor type Models

(Unit: m)

Phase	Capacity(kBtu/h)	Main Piping length		Branch piping length	
		Standard length(m)	Additional refrigerant(g/m)	Standard length(m)	Additional refrigerant(g/m)
1Ø	40	5	50	5	20
	48	5	50	5	20
	56	5	50	5	20
3Ø	42	5	50	5	20
	48	5	50	5	20
	56	5	50	5	20

- Multiple Piping Models

$$\text{Additional charge (g)} = ((A \text{ Room Installation Length} - \text{Standard Length}) \times 20\text{g/m} + (B \text{ Room Installation Length} - \text{Standard Length}) \times 20\text{g/m} + \dots) - CF(\text{Correction Factor}) \times 150$$

* CF = Max. number of connectable indoor unit – Total number of connected indoor unit

- Distributor type Models

$$\text{Additional charge (g)} = ((\text{Total Main piping Length} - \text{Main Standard Length}) \times 50\text{g/m} + (A \text{ Room Branch Length} - \text{Standard Length}) \times 20\text{g/m} + (B \text{ Room Branch Length} - \text{Standard Length}) \times 20\text{g/m} + (C \text{ Room Branch Length} - \text{Standard Length}) \times 20\text{g/m} + \dots) - CF(\text{Correction Factor}) \times 100$$

* CF = Max. number of connectable indoor unit – Total number of connected indoor unit

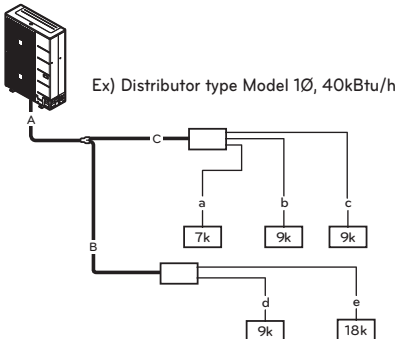

- Total main pipe(A+B+C) = 30m
- Each branch pipe
 - a = 10m
 - b = 8m
 - c = 5m
 - d = 3m
 - e = 10m

*Additional Charge

$$= ((30-5) \times 50 + (10-5) \times 20 + (8-5) \times 20 + (5-5) \times 20 + (3-5) \times 20 + (10-5) \times 20) - (7-5) \times 100 = 1270\text{g}$$

Preparing work for Installation (ART COOL Type Only)

Open panel front

- 1 First, push the front panel backward and lift it up to remove the two screws.
- 2 The moment of lifting the both lower parts of panel front, you can hear sound this panel came out, In this time panel front is separated
- 3 After pull down this panel a bit, and separate connecting wire with product.

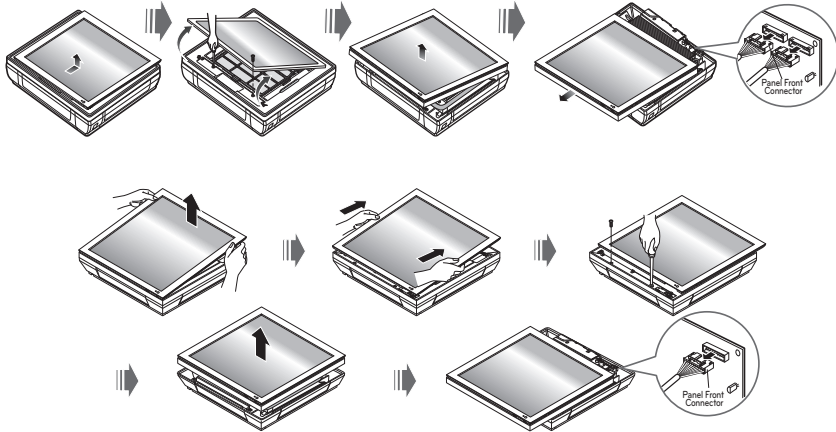

Remove cover pipe and cover side

- 1 Remove two screws (for fixing cover pipe)
- 2 Pull up the cover side of desired connecting direction, then cover side is separated.
- 3 In case of connecting direction is left or right, path through the hole of cover side.

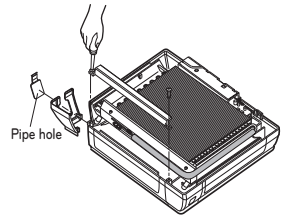

! CAUTION

After removing the pipe hole, cut the burr for safety.

! NOTE

When connecting pipe path through rear wall, don't remove the hole.

Drain hose junction

- 1 Remove the rubber stopple of desired direction of drainage.
- 2 As the following picture, Insert drain hose in the handle of drain pan, and join drain hose and connecting hose.

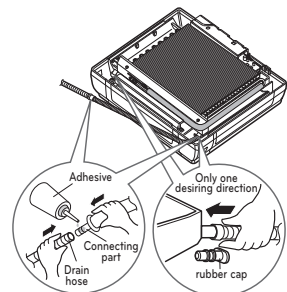

Sticking the installation guide map and fixing Indoor unit (ART COOL Type Only)

Put an Installation Guide Map on the desired surface.

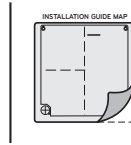

Make a hole with diameter of 6mm and depth of 30-35mm when piercing a screw point.

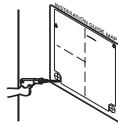

Drive the four plastic anchors into drilled points.

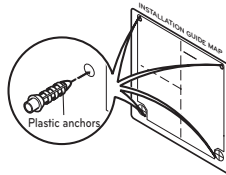

Hang the hole of product at the upper screws.

(In this time, Remove the map)

(Falling attention)

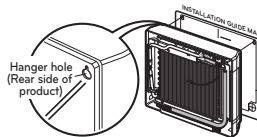

Check the fixed product with light power.

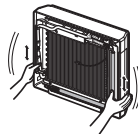

Adjust level even by level gauge and fix to installation for reference on the wall.

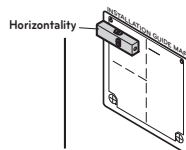

16 INSTALLATION OF INDOOR, OUTDOOR UNIT

Drill the piercing part for connecting pipe as diameter $\varnothing 65\text{mm}$. (In case of piercing rear surface)



Refer to No. 5 on this page when making a hole in the wall.

First, Drive the two points of the upper parts by screws. (Leave 10mm for hanging product)

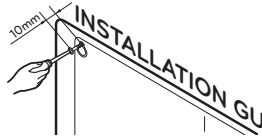

Drive the lower parts after facing the hole of product with plastic anchors, and fix completely the upper screws.

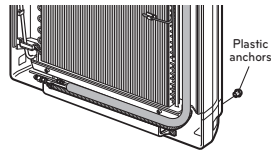

In case of nothing wrong in the matter, connect the pipe and the wire. (Installation manual reference)

Drill a hole in the wall

Drill the piping hole with a $\varnothing 65\text{mm}$ hole core drill. Drill the piping hole at either the right or the left with the hole slightly slanted to the outdoor side.

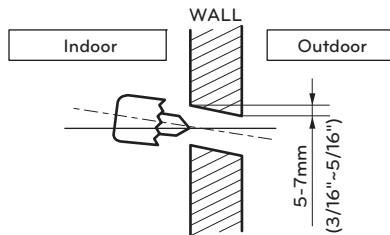

INSTALLATION OF WIRED REMOTE CONTROLLER

- 1 Please fix tightly using provided screw after placing remote controller setup board on the place where you like to setup.
 - Please set it up not to bend because poor setup could take place if setup board bends.
 - Please set up remote controller board fit to the reclamation box if there is a reclamation box.

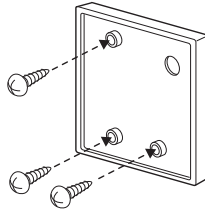

- 2 Can set up Wired remote controller cable into three directions.
 - Setup direction: the surface of wall reclamation, upper, right
 - If setting up remote controller cable into upper and right side, please set up after removing remote controller cable guide groove.

* Remove guide groove with long nose.

- ① Reclamation to the surface of the wall
- ② Upper part guide groove
- ③ Right part guide groove

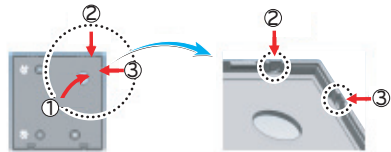

<Wire guide grooves>

- 3 Please fix remote controller upper part into the setup board attached to the surface of the wall, as the picture below, and then, connect with setup board by pressing lower part.
 - Please connect not to make a gap at the remote controller and setup board's upper and lower, right and left part.

<Connecting order>

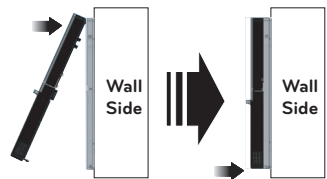

<Separating order>

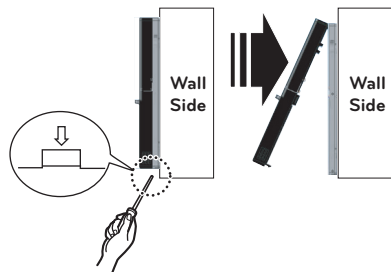

When separating remote controller from setup board, as the picture below, after inserting into the lower separating hole using screw driver and then, spinning clockwise, remote controller is separated.

- There are two separating holes. Please individually separate one at a time.
- Please be careful not to damage the inside components when separating.

18 INSTALLATION OF WIRED REMOTE CONTROLLER

4 Please connect indoor unit and remote controller using connection cable.

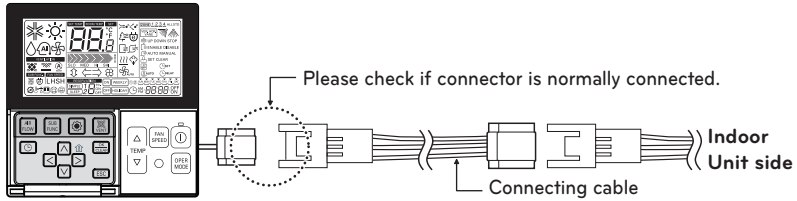

5 Please use extension cable if the distance between wired remote controller and indoor unit is more than 10m.

! CAUTION

When installing the wired remote controller, do not bury it in the wall.

(It can cause damage in the temperature sensor.)

Do not install the cable to be 50m or above.

(It can cause communication error.)

- When installing the extension cable, check the connecting direction of the connector of the remote controller side and the product side for correct installation.
- If you install the extension cable in the opposite direction, the connector will not be connected.
- Specification of extension cable: 2547 1007 22# 2 core 3 shield 5 or above.

Wired remote controller installation

- Since the room temperature sensor is in the remote controller, the remote controller box should be installed in a place away from direct sunlight, high humidity and direct supply of cold air to maintain proper space temperature. Install the remote controller about 5ft(1.5m) above the floor in an area with good air circulation at an average temperature.

Do not install the remote controller where it can be affected by:

- Drafts, or dead spots behind doors and in corners.
- Hot or cold air from ducts.
- Radiant heat from sun or appliances.
- Concealed pipes and chimneys.
- Uncontrolled areas such as an outside wall behind the remote controller.
- This remote controller is equipped with a seven segment LED. display. For proper display of the remote controller LED's, the remote controller should be installed properly as shown in Fig.1. (The standard height is 1.2~1.5 m from floor level.)

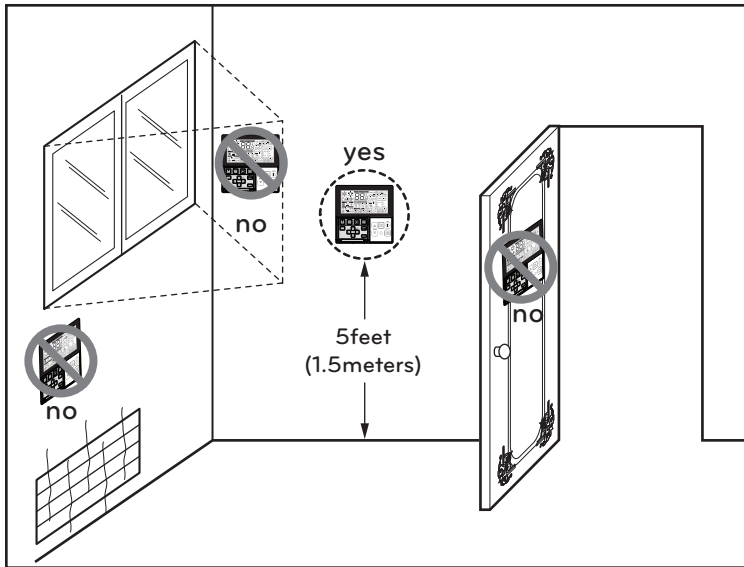

Fig.1 Typical locations for remote controller

FLARING WORK AND CONNECTION OF PIPING

Flaring work

Main cause for gas leakage is due to defect in flaring work. Carry out correct flaring work in the following procedure.

Cut the pipes and the cable

- Use the piping kit accessory or the pipes purchased locally.
- Measure the distance between the indoor and the outdoor unit.
- Cut the pipes a little longer than measured distance.
- Cut the cable 1.5m longer than the pipe length.

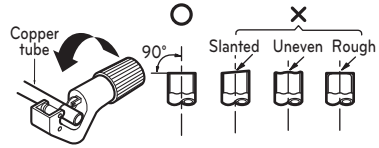

Burrs removal

- Completely remove all burrs from the cut cross section of pipe/tube.
- Put the end of the copper tube/pipe in a downward direction as you remove burrs in order to avoid dropping burrs into the tubing.

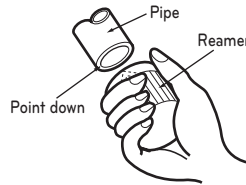

Putting nut on

- Remove flare nuts attached to indoor and outdoor unit, then put them on pipe/tube having completed burr removal. (not possible to put them on after flaring work)

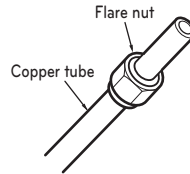

Flaring work

- Carry out flaring work using flaring tool as shown below.

Outside diameter		A
mm	inch	mm
Ø6.35	1/4	1.1~1.3
Ø9.52	3/8	1.5~1.7
Ø12.7	1/2	1.6~1.8
Ø15.88	5/8	1.6~1.8
Ø19.05	3/4	1.9~2.1

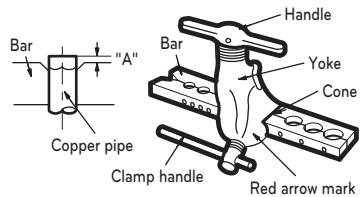

Firmly hold copper pipe in a bar in the dimension shown in the table below.

Check

- Compare the flared work with figure below.
- If flare is noted to be defective, cut off the flared section and do flaring work again.

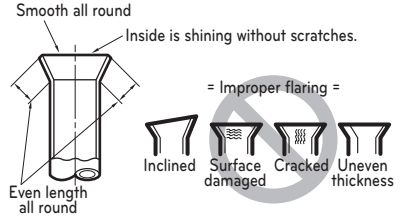

Connection of piping - Indoor

Preparing the indoor unit's piping and drain hose for installation through the wall.

- 1 Route the indoor tubing and the drain hose in the direction of rear left or right

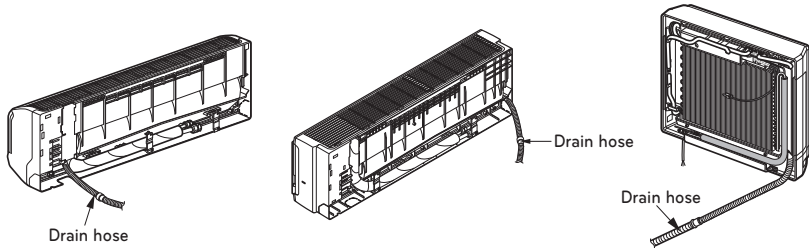

- 2 Tape the tubing, drain hose and the connecting cable. Be sure that the drain hose is located at the lowest side of the bundle. Locating at the upper side can cause drain pan to overflow inside the unit.

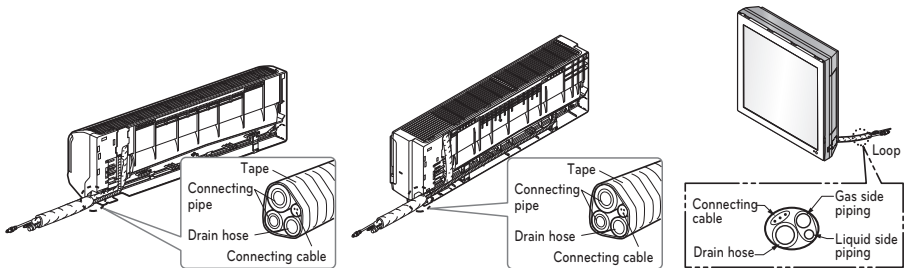

CAUTION

If the drain hose is routed inside the room, insulate the hose with an insulation material* so that dripping from "sweating"(condensation) will not damage furniture or floors.

*Foamed polyethylene or equivalent is recommended.

Indoor unit installation

Hook the indoor unit onto the upper portion of the installation plate.(Engage the two hooks of the rear top of the indoor unit with the upper edge of the installation plate.) Ensure that the hooks are properly seated on the installation plate by moving it left and right. Press the lower left and right sides of the unit against the installation plate until the hooks engage into their slots(clicking sound).

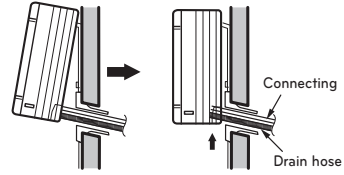

Connecting the pipings to the indoor unit and drain hose to drain pipe

- Align the center of the pipings and sufficiently tighten the flare nut by hand.
- Tighten the flare nut with a wrench.

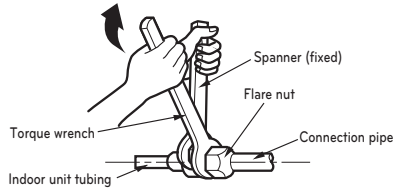
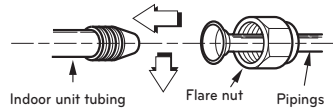

Outside diameter		Torque
mm	inch	N·m
Ø6.35	1/4	16±2
Ø9.52	3/8	38±4
Ø12.7	1/2	55±6
Ø15.88	5/8	75±7
Ø19.05	3/4	110±10

- When extending the drain hose at the indoor unit, install the drain pipe.

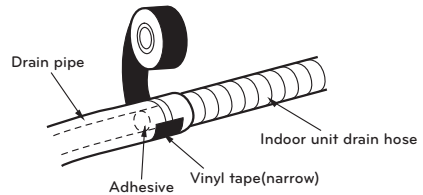

Wrap the insulation material around the connecting portion.

- Overlap the connection pipe insulation material and the indoor unit pipe insulation material. Bind them together with vinyl tape so that there is no gap.
- Wrap the area which accommodates the rear piping housing section with vinyl tape.

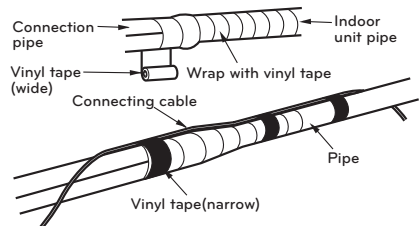
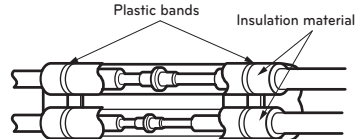

- Bundle the piping and drain hose together by wrapping them with vinyl tape over the range within which they fit into the rear piping housing section.

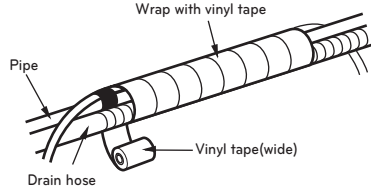

CAUTION

Installation Information (For right piping) For right piping, follow the instruction below.

Good case

Press on the upper side of clamp and unfold the tubing to downward slowly.

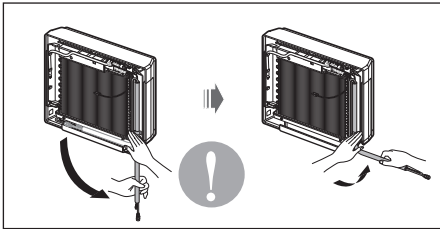

Bad case

Following bending type from left to right could cause problem of pipe damage.

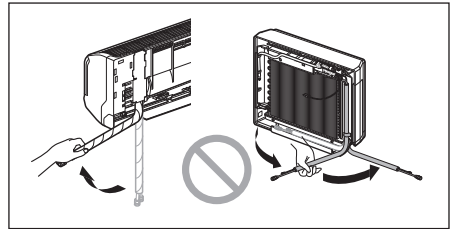

Connection of piping - Outdoor

Align the center of the piping and sufficiently tighten the flare nut by hand.

Connecting pipe order

- 1) ROOM A~E gas side pipe
- 2) ROOM A~E liquid side pipe

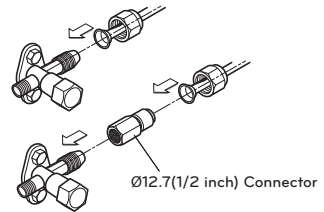

Finally, tighten the flare nut with torque wrench until the wrench clicks.

- When tightening the flare nut with torque wrench ensure the direction for tightening follows the arrow on the wrench.

Outside diameter		Torque N·m
mm	inch	
Ø6.35	1/4	16±2
Ø9.52	3/8	38±4
Ø12.7	1/2	55±6
Ø15.88	5/8	75±7
Ø19.05	3/4	110±10

Outdoor unit

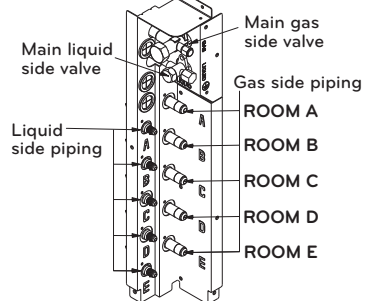

- For the units with capacity more than 48 kBTu/h, the installation piping is connectable in four directions.(refer to figure 1)
- When connecting in a downward direction, knock out the knockout hole of the base pan. (refer to figure 2)

Preventing foreign objects from entering (Figure3)

- Plug the pipe through-holes with putty or insulation material(procured locally)to stop up all gaps,as shown in the figure 3.
- Insects or small animals entering the outdoor unit may cause a short circuit in the electrical box.

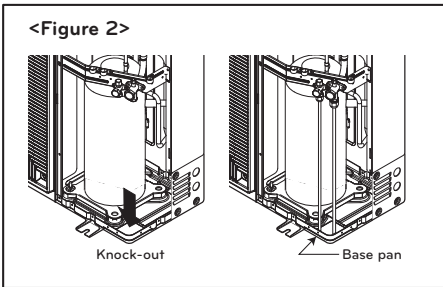
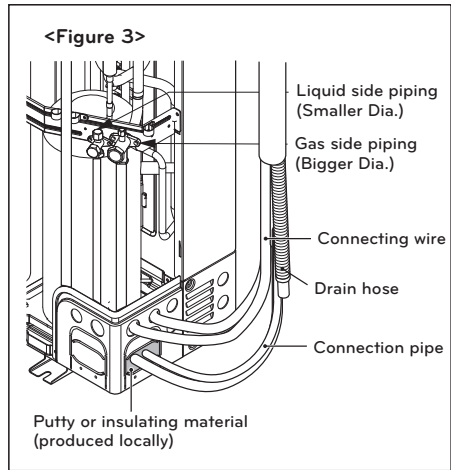
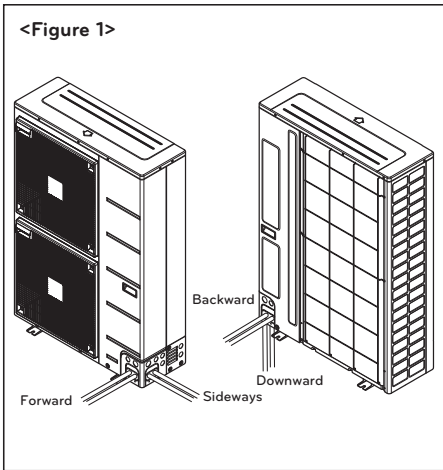
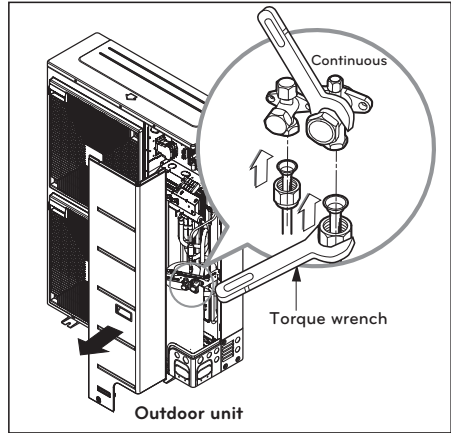

Branch

[unit:mm]

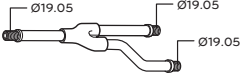
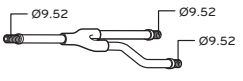
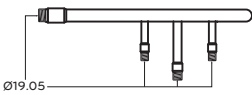
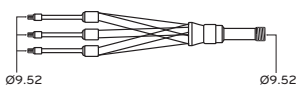
Model	Gas Pipe	Liquid Pipe
PMBL5620		
PMBL1203F0		

Y branch

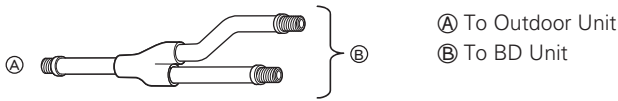

Ensure that the branch pipes are attached horizontally or vertically (see the diagram below.)

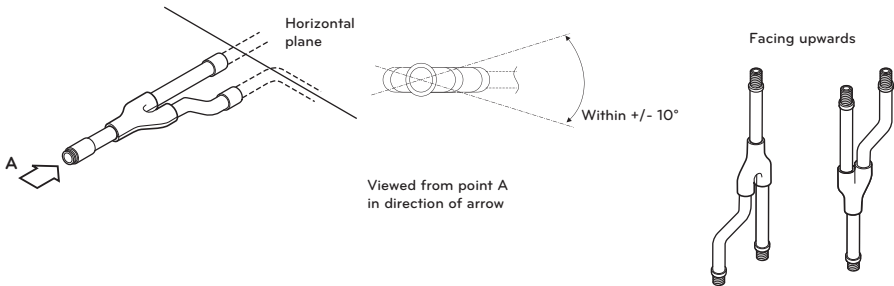

Branch pipe should be insulated with the insulator in each kit.

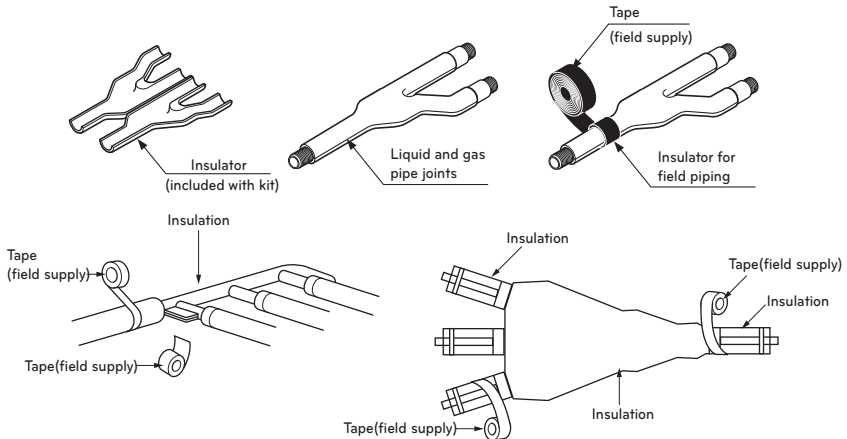

Installation

- This unit may be installed suspended from the ceiling or mounted on the wall.
- This unit may only be installed horizontally, as shown in the diagram below. (Side B is facing up) However, it may be freely installed in any direction forward or back, and to the sides.
- Be sure to leave a 600mm square opening for service and inspection as shown in the diagram below, for both ceiling - suspended installation and wall-mounted installation.
- This unit "does not require drain treatment" as it uses internal foam treatment as low-pressure piping insulation.
- Service direction is the side B and C
- The piping for the indoor unit may be led around in direction A
- The inclination of side B must be within ± 5 degrees forward or back or to the sides.

[unit:mm]

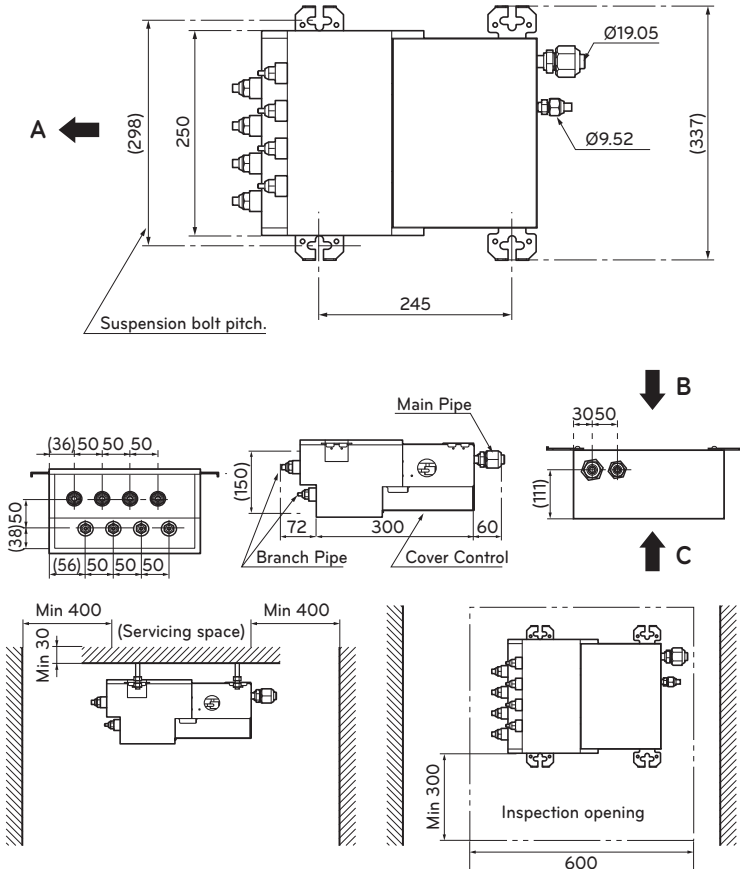

Installation of The Main Unit

(1) Ceiling-suspended type

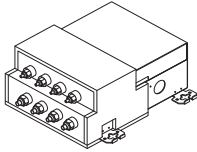

(2) Wall-mount type

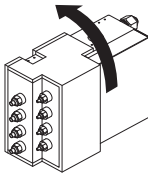

NOTE

- This unit has two different installation types: (1) Ceiling-suspended type and (2) wall-mounted type.
- Choose the proper installation pattern according to the location of installation.
- The installation location for printed wiring board can be changed. Follow the procedure specified in the "CONNECTING THE WIRING" section to change the location.

Ceiling-suspended type

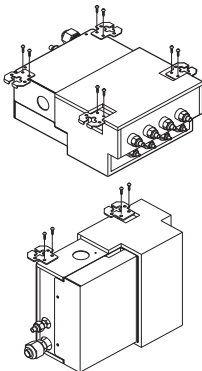

Procedure

- 1 Fix the furnished hanger metal with two screws.(4 locations in total).
- 2 Using an insert-hole-in- anchor, hang the hanging bolt.

- 3 Install a hexagon nut and a flat washer (locally-procured)to the hanging bolt as shown in the figure in the left, and lift the main unit to hang on the hanger metal.

- 4 After checking with a level that the unit is level, tighten the hexagon nut.

* The tilt of the unit should be within $\pm 5^\circ$ in front/back and left/right.

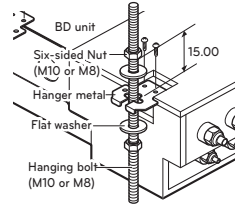

Wall-mounted type

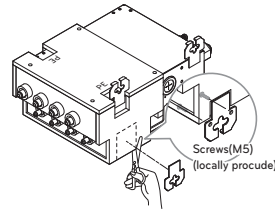

Procedure

- 1 Fix the furnished hanger metal with two screws. (3 locations in total).
- 2 After checking with a level that the unit is level, fix the unit with the furnished wood screws.

* The tilt of the unit should be within $\pm 5^\circ$ in front/back and left/right.

* Block up the parts of hanger holes (2 places) by using insulation PE after installing the hanger.

CAUTION

- Once a screw-hole on the main unit has had a screw hammered in, make sure to either hammer it again or cover it with aluminum tape. (This is to prevent condensation)
- Be sure to install the unit with the ceiling-side up.
- Do not install near bedrooms. the sound of refrigerant flowing through the piping may sometimes be audible.

CONNECTING THE CABLE BETWEEN INDOOR UNIT AND OUTDOOR UNIT

Connect the cable to the Indoor unit

Connect the cable to the indoor unit by connecting the wires to the terminals on the control board individually according to the outdoor unit connection. (Ensure that the color of the wires of the outdoor unit and the terminal No. are the same as those of the indoor unit.)

The earth wire should be longer than the common wires.

The circuit diagram is not subject to change without notice.

When installing, refer to the circuit diagram behind the panel front of Indoor Unit the wiring diagram on the Control Cover Inside Outdoor Unit.

CAUTION

- The circuit diagram is not subject to change without notice.
- Be sure to connect wires according to the wiring diagram.
- Connect the wires firmly, so that not to be pulled out easily.
- Connect the wires according to color codes by referring the wiring diagram.

2 Unit

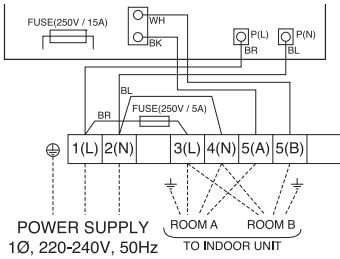

3 Unit

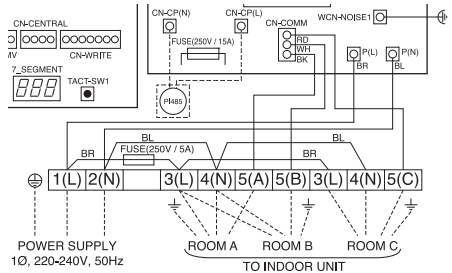

4 Unit

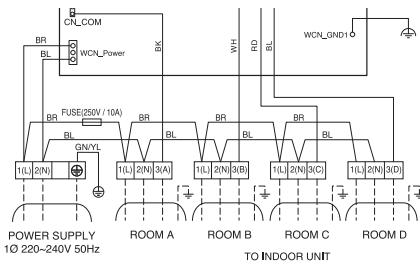

5 Unit

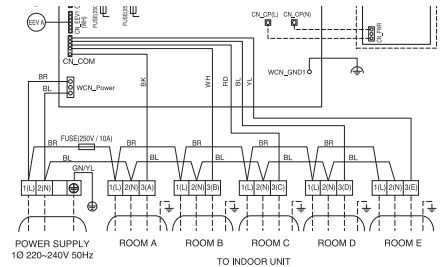

5 Unit

7~9 Unit (1Ø)

7~9 Unit (3Ø)

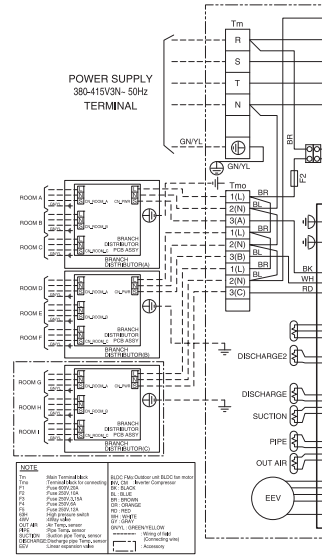
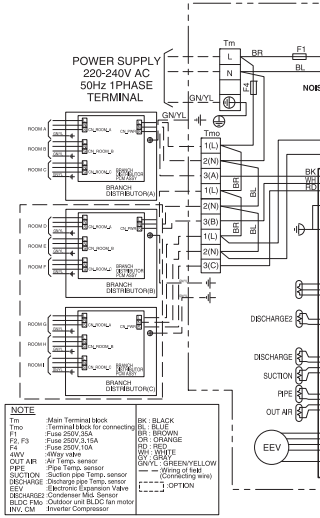
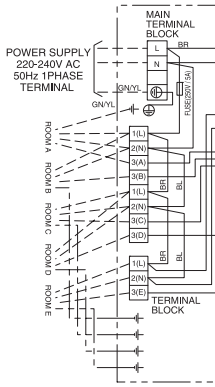

NOTE

Tm	Main Terminal Block	RE, BLACK	Refrigerant
Tno	Terminal block for connecting	BL, BLUE	Blow-off
F1	Fuse 200V, 50A	BR, BROWN	Brake
F2, F3	Fuse 200V, 50A	RD, RED	Refrigerant
F4	Fuse 200V, 50A	OR, ORANGE	Oil
AVE	Average	GR, GREEN	Ground
OUT AIR	Air Temp. sensor	GN/YL, GREEN/YELLOW	(Connecting wire)
PIPE	Pipe Temp. sensor	---	(Supply of heat)
SUCTION	Suction pipe Temp. sensor	---	(Supply of heat)
DISCHARGE	Discharge pipe Temp. sensor	---	(Supply of heat)
EVE	Electronic Expansion Valve	---	(Supply of heat)
RECHARGE	Recharge Mix Sensor	---	(Supply of heat)
RELOC FMS	Outdoor Air Filter (air mass)	---	(Supply of heat)
INV, GM	Inverter Compressor	---	(Supply of heat)

NOTE

Tm	Main Terminal Block	RE, BLACK	Refrigerant
Tno	Terminal block for connecting	BL, BLUE	Blow-off
F1	Fuse 200V, 50A	BR, BROWN	Brake
F2, F3	Fuse 200V, 50A	RD, RED	Refrigerant
F4	Fuse 200V, 50A	OR, ORANGE	Oil
AVE	Average	GR, GREEN	Ground
OUT AIR	Air Temp. sensor	GN/YL, GREEN/YELLOW	(Connecting wire)
PIPE	Pipe Temp. sensor	---	(Supply of heat)
SUCTION	Suction pipe Temp. sensor	---	(Supply of heat)
DISCHARGE	Discharge pipe Temp. sensor	---	(Supply of heat)
EVE	Electronic Expansion Valve	---	(Supply of heat)
RECHARGE	Recharge Mix Sensor	---	(Supply of heat)
RELOC FMS	Outdoor Air Filter (air mass)	---	(Supply of heat)
INV, GM	Inverter Compressor	---	(Supply of heat)

CAUTION

Provide a circuit breaker between power source and the unit as shown below.

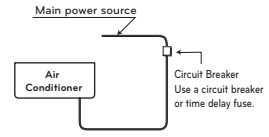

CAUTION

The power cord connected to the outdoor unit should be complied with the following specifications (Cable type approved by HAR or SAA).

Phase	1Ø										3Ø		
Capacity (kbtu/h)	14	16	18	21	24	27	30	40	48	56	42	48	56
NORMAL CROSS SECTIONAL AREA	2.5	2.5	2.5	2.5	2.5	2.5	2.5	3.5	4.0	4.0	2.5	2.5	2.5
Cable Type	H07RN-F												

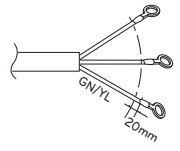

The power connecting cable connected to the indoor and outdoor unit should be complied with the following specifications (This equipment shall be provided with a cord set complying with the national regulation).

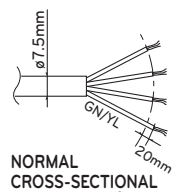

NORMAL CROSS-SECTIONAL AREA 0.75mm² H07RN-F

Connect the cable to the Outdoor unit

- 1 Remove the cover control from the unit by loosening the screw.
Connect the wires to the terminals on the control board individually as the following.
- 2 Secure the cable onto the control board with the holder (clammer).
- 3 Refix the cover control to the original position with the screw.
- 4 Use a recognized circuit breaker between the power source and the unit. A disconnection device to adequately disconnect all supply lines must be fitted.

1Ø Models

Capacity (kBtu/h)	14	16	18	21	24	27	30	40	48	56
Circuit Breaker (A)	15	15	20	20	25	25	30	40	40	40

3Ø Models

Capacity (kBtu/h)	42	48	56
Circuit Breaker (A)	20	20	20

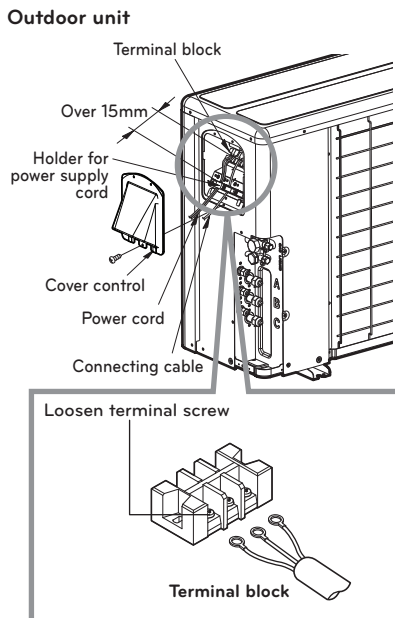

⚠ CAUTION

After the confirmation of the above conditions, prepare the wiring as follows.

- 1 Never fail to have an individual power circuit specifically for the air conditioner. As for the method of wiring, be guided by the circuit diagram posted on the inside of control cover.
- 2 Firmly tighten the terminal screws to prevent them loosening. After tightening, pull the wires lightly to confirm that they do not move. (If they are loose the unit, the unit will not operate normally or it can cause burn-out of the wires.)
- 3 Specification of power source.
- 4 Confirm that electrical capacity is sufficient.
- 5 See to that the starting voltage is maintained at more than 90 percent of the rated voltage marked on the name plate.
- 6 Confirm that the cable thickness is as specified in the power source specification. (Particularly note the relation between cable length and thickness.)
- 7 Do not install an earth leakage circuit breaker in a wet or moist area.
- 8 The following would be caused by voltage drop.
 - Vibration of a magnetic switch, which will damage the contact point, fuse breaking, disturbance of the normal function of the overload.
- 9 The means for disconnection from a power supply shall be incorporated in the fixed wiring and have an air gap contact separation of at least 3mm in each active(phase) conductors.
- 10 The Power cord connected to the unit should be selected according to the following specifications.

Precautions when laying power wiring

Use round pressure terminals for connections to the power terminal block.

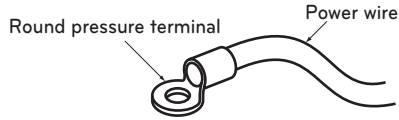

When none are available, follow the instructions below.

- Do not connect wiring of different thicknesses to the power terminal block. (Slack in the power wiring may cause abnormal heat.)
- When connecting wiring which is the same thickness, do as shown in the figure below.

Connect same thickness wiring to both sides.

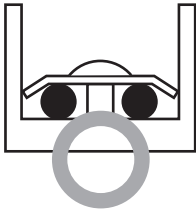

It is forbidden to connect two to one side.

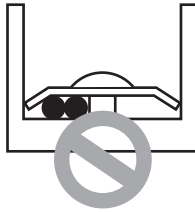

It is forbidden to connect wiring of different thicknesses.

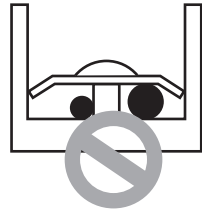

- For wiring, use the designated power wire and connect firmly, then secure to prevent outside pressure being exerted on the terminal block.
- Use an appropriate screwdriver for tightening the terminal screws. A screwdriver with a small head will strip the head and make proper tightening impossible.
- Over-tightening the terminal screws may break them.

Connection of Wiring

- Connect refrigerant pipes and connection wires to the appropriate ports marked with matching alphabets (A, B and C) on this unit.
- Follow the instructions on the wiring nameplate to connect the connection wires of indoor/outdoor units to terminal board numbers. (1, 2 and 3) Always fix each ground wire separately with a ground screw. (See the figure below.)
- After completing the wiring, fix the outer coating of wires securely with wire clamps.
- Refer to the circuit diagram on the control cover inside outdoor unit.

NOTE

The terminal board numbers are arranged from top to bottom in order of 1, 2 and 3.

In Case of 3 rooms

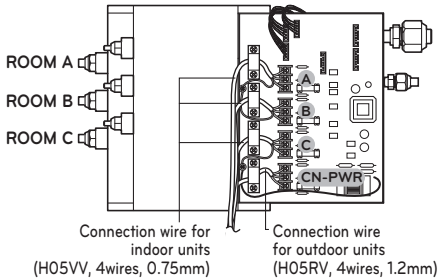

WARNING

Do not use tapped wires, stand wires, extensioncords, or starbust connections, as they may cause overheating, electrical shock, or fire.

- 1 Remove the control cover. Loosen the two screws, and slide the cover in the direction of the arrow.

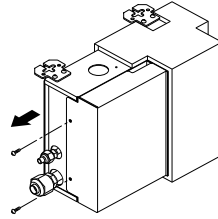

- 2 Perform wiring with reference the wiring diagram on a control cover of outdoor unit. Allow 300 mm for the pulling-out section of harness. Fix the wires completely with wire clamps(4 locations).

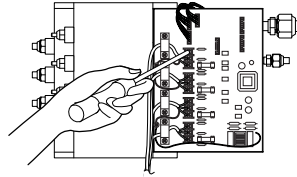

- 3 Put in the cover in the direction of the arrow then tighten the screws.

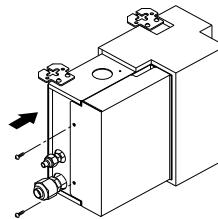

CHECKING THE DRAINAGE AND FORMING THE PIPINGS

Checking the Drainage

To check the drainage.

- 1 Pour a glass of water on the evaporator.
- 2 Ensure the water flows through the drain hose of the indoor unit without any leakage and goes out the drain exit.

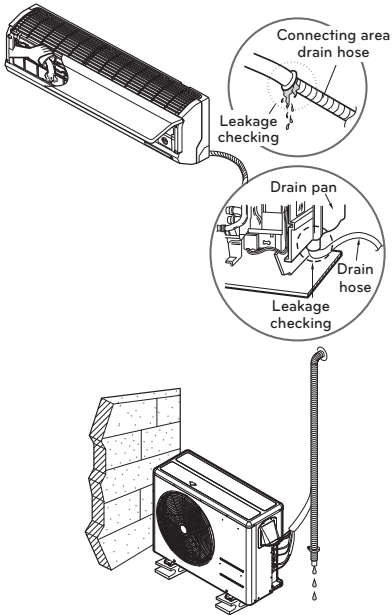

- 2 Do not make drain piping.

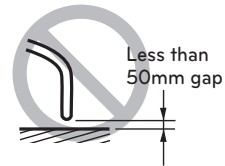
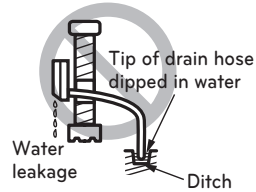
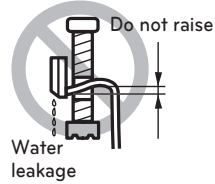

Drain piping

- 1 The drain hose should point downward for easy drain flow.

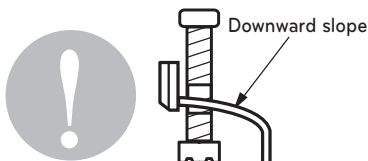

Forming the Piping

Form the piping by wrapping the connecting portion of the indoor unit with insulation material and secure it with two kinds of vinyl tape.

- If you want to connect an additional drain hose, the end of the drain outlet should be routed above the ground. Secure the drain hose appropriately.

In cases where the outdoor unit is installed below the indoor unit perform the following.

- 1 Tape the piping, drain hose and connecting cable from down to up.
- 2 Secure the tapped piping along the exterior wall using saddle or equivalent.

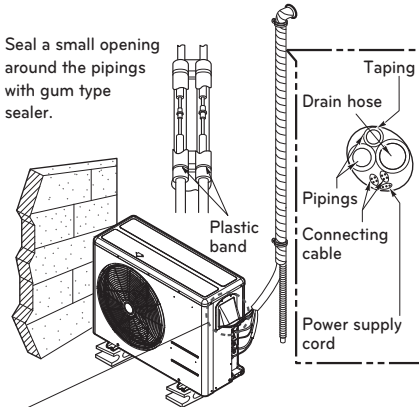

- Trap is required to prevent water from entering into electrical parts.

In cases where the Outdoor unit is installed above the Indoor unit perform the following.

- 1 Tape the piping and connecting cable from down to up.
- 2 Secure the taped piping along the exterior wall. Form a trap to prevent water entering the room.
- 3 Fix the piping onto the wall by saddle or equivalent.

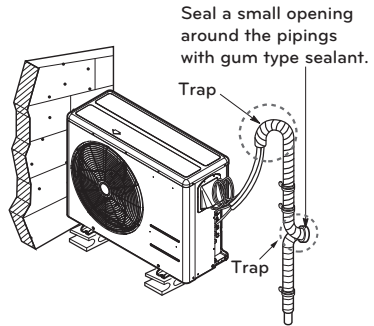

AIR PURGING AND EVACUATION

The air and moisture remaining in the refrigerant system have undesirable effects as indicated below.

- Pressure in the system rises.
- Operating current rises.
- Cooling(or heating) efficiency drops.
- Moisture in the refrigerant circuit may freeze and block capillary tubing.
- Water may lead to corrosion of parts in the refrigeration system.

Therefore, after evacuating the system, take a leak test for the piping and tubing between the indoor and outdoor unit.

Checking method

Preparation

Check that each tube(both liquid and gas side tubes) between the indoor and outdoor units have been properly connected and all wiring for the test run has been completed. Remove the service valve caps from both the gas and the liquid side on the outdoor unit. Check that both the liquid and the gas side service valves on the outdoor unit are kept closed at this stage.

Leakage test

Connect the manifold valve(with pressure gauges) and dry nitrogen gas cylinder to this service port with charge hoses.

CAUTION

Be sure to use a manifold valve for leakage test. If it is not available, use a stop valve for this purpose. The "Hi" knob of the manifold valve must always be kept close.

- Pressurize the system to no more than 551 P.S.I.G. with dry nitrogen gas and close the cylinder valve when the gauge reading reached 551 P.S.I.G. Next, test for leaks with liquid soap.

CAUTION

To avoid nitrogen entering the refrigerant system in a liquid state, the top of the cylinder must be higher than its bottom when you pressurize the system. Usually, the cylinder is used in a vertical standing position.

- Do a leakage test of all joints of the tubing(both indoor and outdoor) and both gas and liquid side service valves. Bubbles indicate a leak. Be sure to wipe off the soap with a clean cloth.
- After the system is found to be free of leaks, relieve the nitrogen pressure by loosening the charge hose connector at the nitrogen cylinder. When the system pressure is reduced to normal, disconnect the hose from the cylinder.

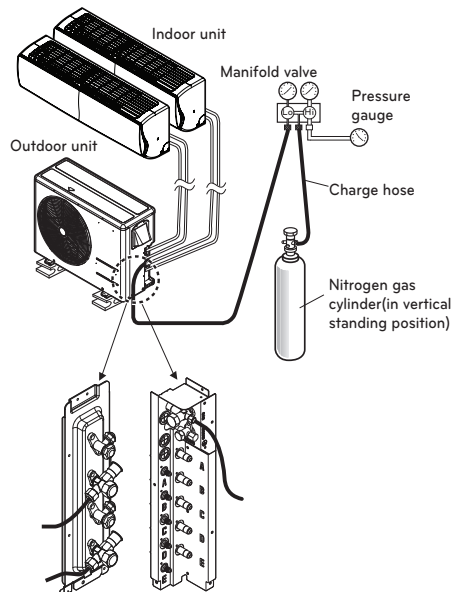

! WARNING

Use a vacuum pump or Inert (nitrogen) gas when doing leakage test or air purge. Do not compress air or Oxygen and do not use Flammable gases. Otherwise, it may cause fire or explosion.

- There is the risk of death, injury, fire or explosion.

Evacuation

- Connect the charge hose end described in the preceding steps to the vacuum pump to evacuate the tubing and indoor unit. Confirm the "Lo" knob of the manifold valve is open. Then, run the vacuum pump. The operation time for evacuation varies with tubing length and capacity of the pump. The following table shows the time required for evacuation.

Required time for evacuation when 30 gal/h vacuum pump is used	
If tubing length is less than 10m (33 ft)	If tubing length is longer than 10m (33 ft)
Less than 0.5 Torr	Less than 0.5 Torr

- When the desired vacuum is reached, close the "Lo" knob of the manifold valve and stop the vacuum pump.

Finishing the Job

- With a service valve wrench, turn the valve stem of liquid side valve counter-clockwise to fully open the valve.
- Turn the valve stem of gas side valve counter-clockwise to fully open the valve.
- Loosen the charge hose connected to the gas side service port slightly to release the pressure, then remove the hose.
- Replace the flare nut and its bonnet on the gas side service port and fasten the flare nut securely with an adjustable wrench. This process is very important to prevent leakage from the system.

- Replace the valve caps at both gas and liquid side service valves and fasten them tight.

This completes air purging with a vacuum pump. The air conditioner is now ready to test run.

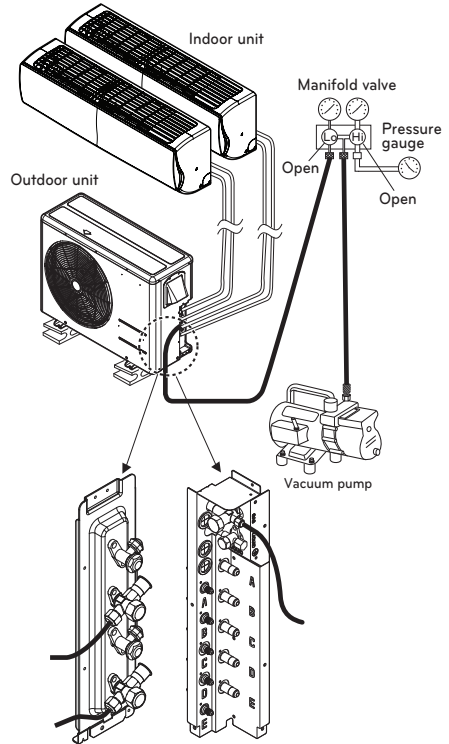

PANEL FRONT ASSEMBLY (ART COOL TYPE ONLY)

- 1 First, Check the side cover assembly exactly, Fix power cord in the bottom groove of cover side left.

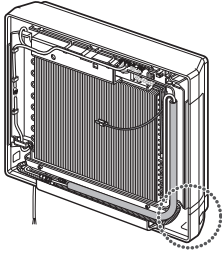

- 2 Assemble connecting lead wire with controller and first fix the upper part of panel front, then match the lower part of panel front

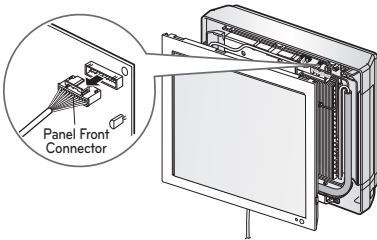
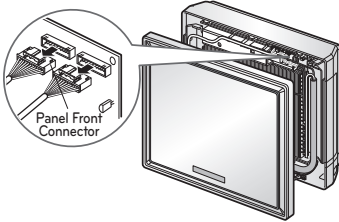

- 3 Suspend hook of front panel in the groove after contract lower of 2 screws.

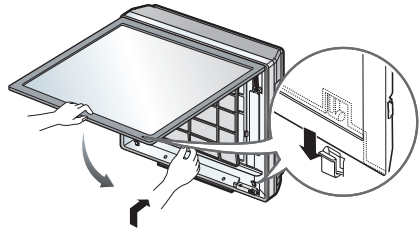
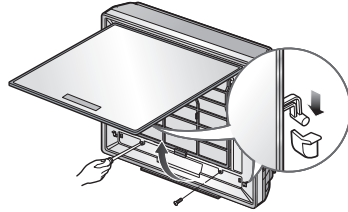

INSTALLATION PI485

Fix the PI485 PCB as shown in Fig.

Detailed installation method refer to PI485 Installation Manual.

18k Btu/h, 21k Btu/h

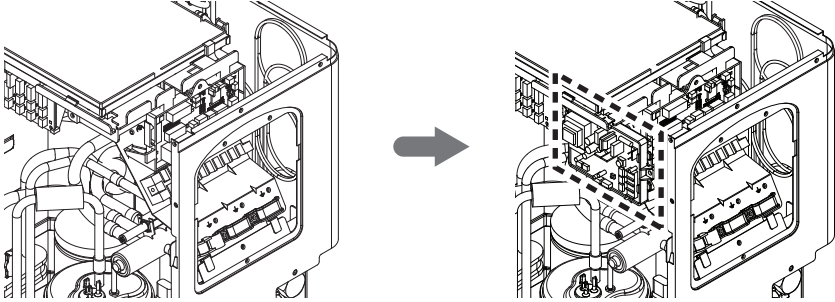

24k Btu/h, 27k Btu/h, 30k Btu/h

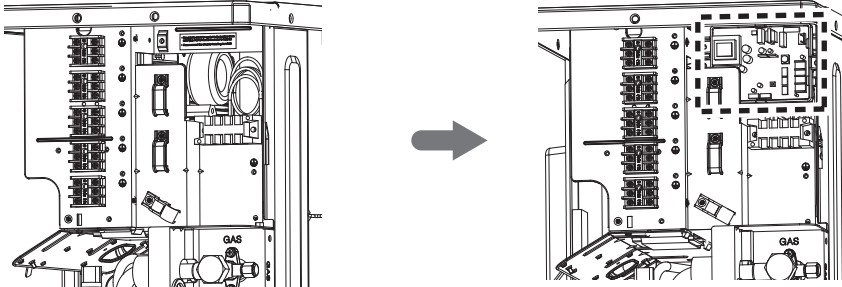

1Ø : 40k Btu/h, 48k Btu/h, 56k Btu/h

3Ø : 42k Btu/h, 48k Btu/h, 56k Btu/h

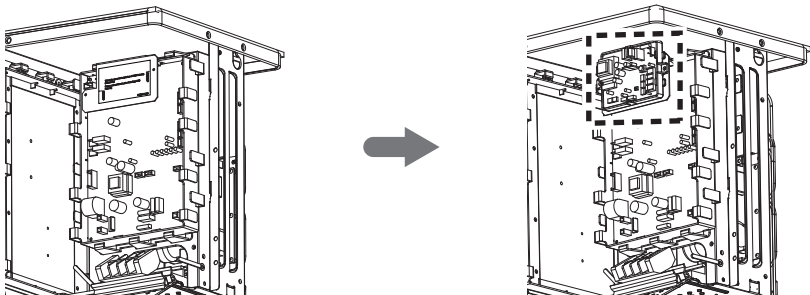

TEST RUNNING

- Check that all tubing and wiring have been properly connected.
- Check that the gas and liquid side service valves are fully open.

Prepare remote control

Remove the battery cover by pulling it according to the arrow direction.

Insert new batteries making sure that the (+) and (-) of battery are installed correctly.

Reattach the cover by pushing it back into position.



! NOTE

- Use 2 AAA(1.5volt) batteries. Do not use rechargeable batteries.
- Remove the batteries from the remote control if the system is not going to be used for a long time.

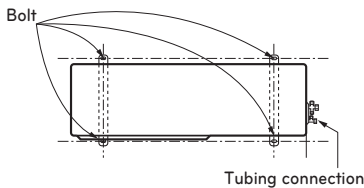

Evaluation of the performance

Operate unit for 15~20 minutes, then check the system refrigerant charge:

- Measure the pressure of the gas side service valve.
- Measure the temperature of the intake and discharge of air.
- Ensure the difference between the intake temperature and the discharge is more than 8°C.

- For reference, the gas side pressure of optimum condition is as below.(Cooling)

Refrigerant	Outside ambient TEMP.	The pressure of the gas side service valve.
R410A	35°C (95°F)	8.5~9.5kg/cm ² G (120~135 P.S.I.G.)

! NOTE

If the actual pressure are higher than shown, the system is most likely over-charged, and charge should be removed. If the actual pressure are lower than shown, the system is most likely under-charged, and charge should be added. The air conditioner is now ready for use.

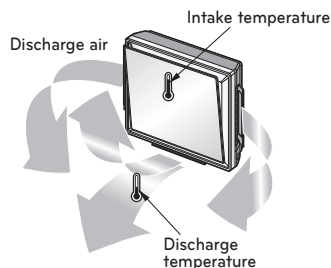
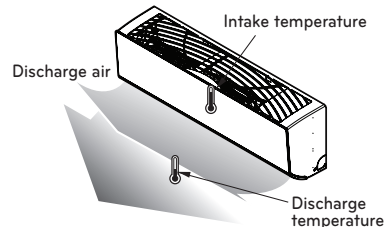
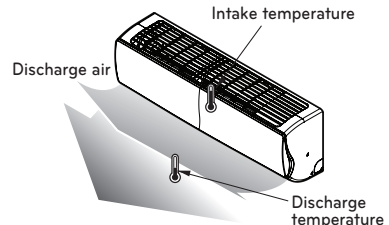

FUNCTION

Dip S/W Setting

If you set the Dip Switch when power is on, the change in setting is not applicable. The changing setting is enabled only when Power is reset.

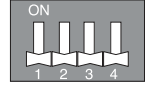

Dip Switch	Function
1 2 3 4	
	Normal Operation (No Function)
	Forced Cooling Operation
	Wiring Error Check
	Saving Power Consumption (Step 1)
	Saving Power Consumption (Step 2)
	Mode Lock (Cooling)
	Mode Lock (Heating)
	Night Quiet Mode (Step 1)
	Night Quiet Mode (Step 2)
	Mode Lock (Cooling) + Night Quiet Mode (Step 1)
	Mode Lock (Cooling) + Night Quiet Mode (Step 2)
	Mode Lock (Cooling) + Saving Power Consumption (Step 1)
	Mode Lock (Cooling) + Saving Power Consumption (Step 2)
	Mode Lock (Heating) + Saving Power Consumption (Step 1)
	Mode Lock (Heating) + Saving Power Consumption (Step 2)

! WARNING

When you set the dip switch, you should turn off the circuit breaker or shut the power source of the product down.

! CAUTION

- Unless the applicable dip switch is set properly, the product may not work.
- If you want to set a specific function, request that the installer sets the dip switch appropriately during installation.

14/16/18/21(1Ø) kBTu/h

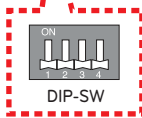
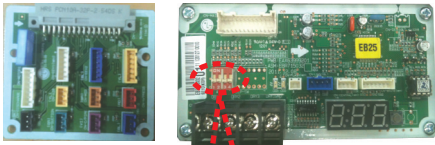

40/48/56(1Ø) kBTu/h

42/48/56(3Ø) kBTu/h

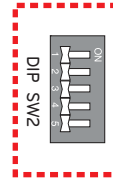
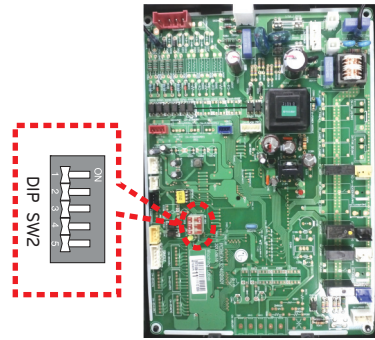

Forced Cooling Operation

Adding the refrigerant in winter.

Setting Procedure

- 1 Set the Dip Switch as follow after shutting the power source down.

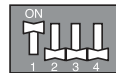

- 2 Reset the power.
- 3 Check that the Red LED of PCB is on during work.
(The indoor unit is operated by force.)
- 4 Add the specific amount of refrigerant.

24/27/30(1Ø) kBTu/h

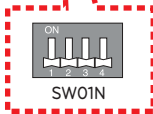
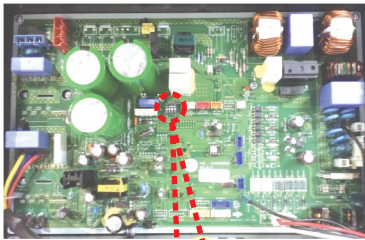

! CAUTION

- When the green LED of PCB is on, compressor is going to be off because of low pressure.
- You should return the Dip Switch to operate normally after finishing the operation.

Wiring Error Check

You can check whether or not the wiring is correct.

Setting Procedure

- 1 Set the Dip Switch as follow after shutting the power source down.

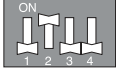

- 2 Reset the power.
- 3 Check that the Red and Green LED of PCB are on during work. (The indoor unit is operated by force.)
- 4 If the wiring is correct, the Green LED will light up.
If the wiring is wrong, display as below (Display only wrong connection.)
 - Red LED : Piping Number
 - Green LED : Wiring Number (Room)

Example)

If the Red LED blinks twice and the Green LED blinks 3 times, 2nd pipe is connected to 3rd room.

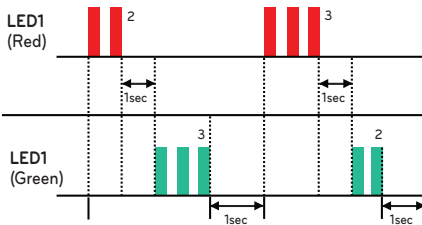

- 5 You should return the Dip Switch to operate normally after finishing wiring error check.



CAUTION

- If Indoor unit doesn't communicate to outdoor Unit, function could not be operated correctly.
- Only the wrong wiring connection is displayed. You should change connection correctly to operate the product.
- If Outdoor and Indoor temperature is too low in winter, the wiring error check function will not be operated. (Red LED is lighting)

Saving Power Consumption

Saving Power Consumption operation is the function which enables efficient operation by lowering the maximum power consumption value.

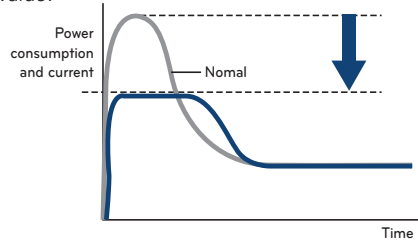

Setting Procedure

- 1 Set the Dip Switch as follow after shutting the power source down.

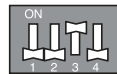

Step 1

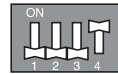

Step 2

- 2 Reset the power.

Saving Power Consumption Current level.

Phase	1Ø										3Ø		
	14k	16k	18k	21k	24k	27k	30k	40k	48k	56k	42k	48k	56k
Step1(A)	8	8	9	9	12	13	15	22	24	26	7	8	9
Step2(A)	7	7	8	8	10	11	13	18	20	22	6	7	8

Saving Power Consumption with Mode Lock.

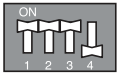

Saving Power
Consumption (step 1)
+ Mode Lock (Cooling)

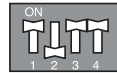

Saving Power
Consumption (step 1)
+ Mode Lock (Heating)

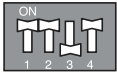

Saving Power
Consumption (step 2)
+ Mode Lock (Cooling)

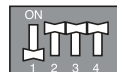

Saving Power
Consumption (step 2)
+ Mode Lock (Heating)

Night Quiet Mode

Night Quiet Mode operation lowers the noise level of the outdoor unit by changing the comp frequency and fan speed. This function is operated all night long.

Setting Procedure

1 Set the Dip Switch as follow after shutting the power source down.

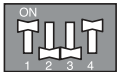

Step 1

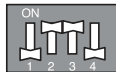

Step 2

* Noise level :Step 1 > Step 2

2 Reset the power.

Night Quiet Mode with Mode Lock.



Mode Lock (Cooling)
+ Night Quiet Mode
(step 1)

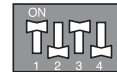

Mode Lock (Cooling)
+ Night Quiet Mode
(step 2)

CAUTION

- If comp frequency and fan speed are down, the cooling capacity may decrease accordingly.
- This function is only available for Cooling Mode.
- If you want to stop the Night Quiet Mode, Change the Dip Switch.
- If operating indoor unit is set by the fan speed "Power", Night Quiet Mode will be stopped until fan speed "Power" is changed.

Mode Lock

Setting Procedure

- 1 Set the Dip Switch as follow after shutting the power source down.

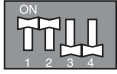

Only Cooling Mode

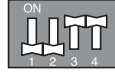

Only Heating Mode

- 2 Reset the power.

Mode Lock with Night Quiet Mode

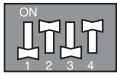

Mode Lock (Cooling)
+ Night Quiet Mode
(step 1)



Mode Lock (Cooling)
+ Night Quiet Mode
(step 2)

Saving Power Consumption with Mode Lock.

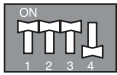

Mode Lock (Cooling)
+ Saving Power
Consumption (step 1)



Mode Lock (Heating)
+ Saving Power
Consumption (step 1)

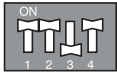

Mode Lock (Cooling)
+ Saving Power
Consumption (step 2)

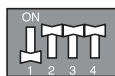

Mode Lock (Heating)
+ Saving Power
Consumption (step 2)

PCB Display(14/16/18/21k Model Only)

It is useful to check the cycle data without LGMV.

Operating Method

Whenever you push the Tact Switch, the cycle information will be shown as below.

※ After 1page is displayed, subsequently 2page is displayed.

Tact S/W		Item	Display		
14/16k	18/21k		Example	1page	2page
-	1 time	Low Pressure	890kpa	'LP'	' 89'
-	2 time	Hi Pressure	2900kpa	'HP'	'290'
1 time	3 time	Discharge Temp.	85°C	'DS'	' 85'
2 time	4 time	Cond Out Temp.	-10°C	'CS'	'-10'
3 time	5 time	Suction Temp.	-10°C	'SS'	'-10'
4 time	6 time	ODU Air Temp.	-10°C	'AS'	'-10'
5 time	7 time	Current	15A	'A'	' 15'
6 time	8 time	Voltage	230V	'V'	'230'
7 time	9 time	Comp Hz	100Hz	'F'	'100'
8 time	10 time	DC Link Voltage	230V	'dc'	'230'



! WARNING

When you push the Tact Switch, use the material non-conducting electricity.

MAX COMBINATION CAPACITY

Multi Piping Type

Capacity (kBtu/h)	Max Room No.	Combination Indoor Capacity (kBtu/h)	Max Combination Capacity (kBtu/h)
14	2	5,7,9,12	21
16	2	5,7,9,12	24
18	3	5,7,9,12,18	30
21	3	5,7,9,12,18	33
24	4	5,7,9,12,18,24	39
27	4	5,7,9,12,18,24	41
30	5	5,7,9,12,18,24	48
40	5	5,7,9,12,18,24	52

Distributor Type

Phase	Capacity (kBtu/h)	Max Room No.	Combination Indoor Capacity (kBtu/h)	Combination Capacity Range (kBtu/h)
1Ø	40	7	5, 7, 9, 12, 18, 24	16~52
	48	8	5, 7, 9, 12, 18, 24	19~63
	56	9	5, 7, 9, 12, 18, 24	23~73
3Ø	42	7	5, 7, 9, 12, 18, 24	16~54
	48	8	5, 7, 9, 12, 18, 24	19~63
	56	9	5, 7, 9, 12, 18, 24	23~73

The combination of indoor unit is to be decided that the sum of indoor unit capacity index must be smaller than the maximum combination capacity of outdoor unit. We recommend to calculate indoor unit capacity like below.

If you do not follow our recommendation, it will have some problems in low ambient condition i.e. some indoor unit will not be able to heat very well in heating mode.

CALCULATION METHOD FOR THE CONNECTABLE TOTAL CAPACITY OF INDOOR UNIT

Sum up the capacity of all indoor unit, but high static duct type indoor unit capacity weights 1.3 times

- Ex) 1 Outdoor unit : A9UW566FA3(FM56AH)(connectable maximum capacity is 73kBtu)
Indoor unit:
AMNH186BHA0[MB18AH],AMNH246BHA0[MB24AH],AMNH246BHA0[MB24AH]
(18 + 24 + 24) × 1.3 = 66 × 1.3 = 85.8kBtu: this combination has a some problem
- 2 Out door unit: FM56AH
Indoor unit:
AMNH186BHA0[MB18AH],AMNH246BHA0[MB24AH],AMNH18GD5L0[MS18AH]
(18 + 24) × 1.3 + 18 + 72.6: this combination can be ok

INSTALLATION GUIDE AT THE SEASIDE

CAUTION

- Air conditioners should not be installed in areas where corrosive gases, such as acid or alkaline gas, are produced.
- Do not install the product where it could be exposed to sea wind (salty wind) directly. It can result corrosion on the product. Corrosion, particularly on the condenser and evaporator fins, could cause product malfunction or inefficient performance.
- If outdoor unit is installed close to the seaside, it should avoid direct exposure to the sea wind. Otherwise it needs additional anticorrosion treatment on the heat exchanger.

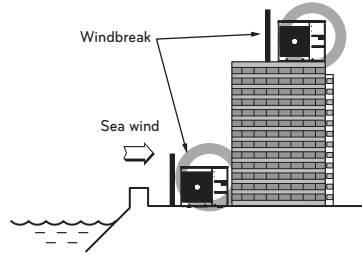

- It should be strong enough like concrete to prevent the sea wind from the sea.
- The height and width should be more than 150% of the outdoor unit.
- It should be keep more than 70 cm of space between outdoor unit and the windbreak for easy air flow.

Place with fluent water draining

- Install at a place with fluent water draining to prevent damage from localized heavy rain and avoid frequent flooded area.

Selecting the location(Outdoor Unit)

If the outdoor unit is to be installed close to the seaside, direct exposure to the sea wind should be avoided. Install the outdoor unit on the opposite side of the sea wind direction.

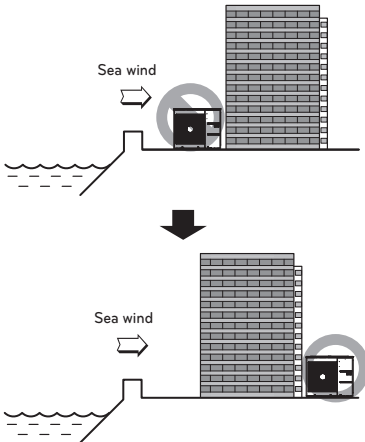

In case, to install the outdoor unit on the seaside, set up a windbreak not to be exposed to the sea wind.

- Periodic (more than once/year) cleaning of the dust or salt particles stuck on the heat exchanger by using water.

SEASONAL WIND AND CAUTIONS IN WINTER

- Sufficient measures are required in a snow area or severe cold area in winter so that product can be operated well.
- Get ready for seasonal wind or snow in winter even in other areas.
- Install a suction and discharge duct not to let in snow or rain.
- Install the outdoor unit not to come in contact with snow directly. If snow piles up and freezes on the air suction hole, the system may malfunction. If it is installed at snowy area, attach the hood to the system.
- Install the outdoor unit at the higher installation console by 50cm than the average snowfall (annual average snowfall) if it is installed at the area with much snowfall.
- Where snow accumulated on the upper part of the Outdoor Unit by more than 10cm, always remove snow for operation.

- 1 The height of H frame must be more than 2 times the snowfall and its width shall not exceed the width of the product. (If width of the frame is wider than that of the product, snow may accumulate)
- 2 Don't install the suction hole and discharge hole of the Outdoor Unit facing the seasonal wind.

Model Designation

Indoor unit

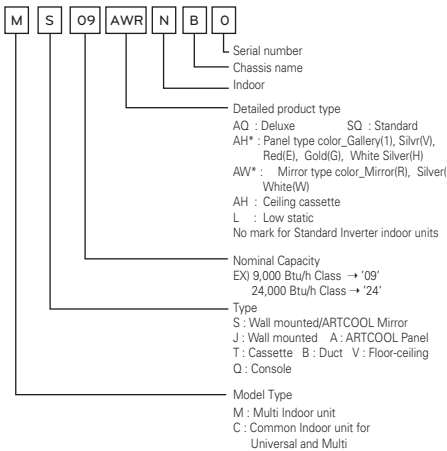

Outdoor unit

MULTI F.

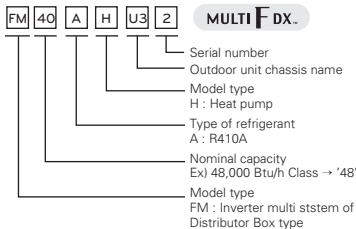
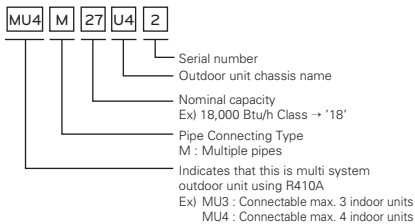

MULTI F DX.

Airborne Noise Emission

The A-weighted sound pressure emitted by this product is below 70 dB.

** The noise level can vary depending on the site.

The figures quoted are emission level and are not necessarily safe working levels. Whilst there is a correlation between the emission and exposure levels, this cannot be used reliably to determine whether or not further precautions are required. Factor that influence the actual level of exposure of the workforce include the characteristics of the work room and the other sources of noise, i.e. the number of equipment and other adjacent processes and the length of time for which an operator exposed to the noise. Also, the permissible exposure level can vary from country to country. This information, however, will enable the user of the equipment to make a better evaluation of the hazard and risk.

Limiting concentration

Limiting concentration is the limit of Freon gas concentration where immediate measures can be taken without hurting human body when refrigerant leaks in the air. The limiting concentration shall be described in the unit of kg/m³ (Freon gas weight per unit air volume) for facilitating calculation.

Limiting concentration: 0.44kg/m³(R410A)

Calculate refrigerant concentration

$$\text{Refrigerant concentration} = \frac{\text{Total amount of replenished refrigerant in refrigerant facility (kg)}}{\text{Capacity of smallest room where indoor unit is installed (m}^3\text{)}}$$

