

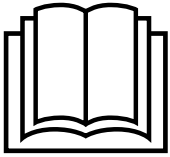

OWNER'S MANUAL

VACUUM CLEANER



Before beginning installation, read these instructions carefully. This will simplify installation and ensure that the product is installed correctly and safely. Leave these instructions near the product after installation for future reference.

ENGLISH

A9LSLIM

www.lg.com

TABLE OF CONTENTS

This manual may contain images or content that may be different from the model you purchased. This manual is subject to revision by the manufacturer.

SAFETY INSTRUCTIONS

- READ ALL INSTRUCTIONS BEFORE USE 03
- WARNING 03
- CAUTION 09

INSTALLATION

- Product Overview 10
- Installing the Charging Station 13
- Storing the Accessories 14
- Charging the Battery 15

OPERATION

- Getting Started 16
- Operational Controls 17
- Using the Nozzles and Tools 18

MAINTENANCE

- Cleaning the Appliance 19
- Cleaning the Nozzles 22

TROUBLESHOOTING

- Before Calling for Service 23

SAFETY INSTRUCTIONS

READ ALL INSTRUCTIONS BEFORE USE

The following safety guidelines are intended to prevent unforeseen risks or damage from unsafe or incorrect operation of the appliance. The guidelines are separated into 'WARNING' and 'CAUTION' as described below.

Safety Messages

 This symbol is displayed to indicate matters and operations that can cause risk. Read the part with this symbol carefully and follow the instructions in order to avoid risk.

WARNING

This indicates that the failure to follow the instructions can cause serious injury or death.

CAUTION

This indicates that the failure to follow the instructions can cause the minor injury or damage to the product.

WARNING

WARNING

- To reduce the risk of explosion, fire, death, electric shock, injury or scalding to persons when using this product, follow basic precautions, including the following:

Technical Safety

- This appliance is not intended for use by persons (including children) with reduced physical, sensory or mental capabilities, or lack of experience and knowledge, unless they have been given supervision or instruction concerning use of the appliance by a person responsible for their safety. Children should be supervised to ensure that they do not play with the appliance.
- Do not allow the appliance to be used as a toy. Close attention is necessary when used by or near children.

- Do not allow children to play with or hang on the appliance
- Do not use the appliance with damaged power cord or plug. The cord must be replaced. If the appliance is not working as it should, has been dropped, damaged, left outdoors, or dropped into water, return it to an LG Electronics service centre.
- Do not pull or carry by cord, use cord as a handle, close a door on cord, or pull cord around sharp edges or corners. Do not run appliance over cord. Keep cord away from heated surfaces.
- Do not unplug by pulling on cord. To unplug, grasp the plug, not the cord.
- Place the cords from other appliances out of the area to be cleaned.

Battery

- Never use the battery, adapter, and the charging station from other appliances with this appliance. Use only the battery and the charging station provided by LG Electronics.
- Never use the battery, adapter, and the charging station from this appliance with other appliances.
- Unplug the power cord and remove the battery if the appliance will not be used for an extended period of time.
- Do not use modified or damaged batteries.
- Do not disassemble, remove or short-circuit the battery.
- When disposing of the battery or the appliance, remove the battery from the appliance and safely dispose of it.
- Have specifically designated battery packs replaced when it is no longer able to hold a charge.
- Refer to the Charging the Battery section instructions for the method of replacing the battery.
- When disposing of this appliance, follow regulations for disposal of rechargeable lithium-ion batteries.
- Follow all local ordinances and regulations when handling or disposing of the battery.
- Prevent unintentional starting. Ensure the switch is in the off position before connecting to the battery pack, picking up or carrying the appliance.
- Disconnect the battery pack from the appliance before making any adjustments, changing accessories, cleaning, servicing, or storing appliance.
- When battery pack is not in use, keep it away from other metal objects, like paper clips, coins, keys, nails, screws or other small metal objects, that can make a connection from one terminal to another.
- Under abusive conditions, liquid may be ejected from the battery. If this

happens, avoid contact. If contact accidentally occurs, flush with water. If liquid contacts eyes, additionally seek medical help.

- If the appliance is to be stored unused for a long period, the batteries should be removed.
- Before removing the battery, you must turn off this appliance.
- When fitting the battery into the product body, insert it completely until it clicks.

Battery Specifications

- **Model Name:** VC-2339-5S1P
- **Type:** Rechargeable Lithium-ion Battery
- **Rated Capacity:** 2500 mAh

Installation

- To avoid an electrical shock or fire, do not install, charge or store the appliance where it may be exposed to water, rainfall or high humidity.
- Install, charge and store the appliance in a well-ventilated place.
- Avoid operating the appliance in areas where there is a risk of leakage of flammable gas, industrial oil or metallic dust.
- Do not store or install the appliance, power cord or plug near heating devices or open flames.
- Install the charging station on a firm, level surface.
- Do not use or store the appliance at temperatures below 5 °C or above 38 °C.
- Do not store or install the appliance where it is exposed to temperatures below freezing or exposed to outdoor weather conditions.
- When installing or moving the appliance, be careful not to pinch, crush, or damage the power cord or plug.
- Use the anchoring screws only when attaching to concrete or similar solid surfaces.
- Never drill into a wall without first checking that the area behind it is free from power conduits, plumbing, vents, or cables.

Operation

- Read all instructions before using the appliance, and save these instructions.
- Use only as described in this manual. Use only manufacturer's recommended attachment.
- This appliance is designed for normal indoor domestic use only. It is not to

be used for any non-residential, commercial, or industrial application.

- This product should only be used with a 100 - 240 V~ 50/60 Hz outlet. Make sure to check the power specifications of the place where you intend to use the appliance.
- Do not handle the power cord, plug, or appliance controls with wet hands.
- Wipe any moisture or dirt off the cord or plug with a dry cloth.
- Never attempt to operate this appliance if it is damaged, malfunctioning, partially disassembled, or has missing or broken parts, including a damaged cord or plug. Take it to an authorized LG Electronics service centre or dealer for assistance.
- Do not apply excessive force to the power cord to bend it, or place it under a heavy object as this will damage it.
- Do not use multiple-outlet adapters with this appliance. Make sure to use a power socket with a capacity of 10 A.
- Do not plug the appliance into a damaged or loose outlet.
- Make sure to unplug the power cord when the appliance is not to be used for an extended period of time.
- Do not damage, alter, excessively bend, twist, pull, pinch or heat the power cord.
- Before using the appliance, remove any wire or string on the floor.
- Avoid touching the prongs of the power plug with your finger(s) when unplugging the power cord.
- Do not cover the power cord with a rug or carpeting.
- Push the power plug firmly into the wall outlet so that it is not loose.
- If the product has been submerged, contact an LG Electronics service centre or dealer for instructions before resuming use.
- If the product makes a strange noise or emits an odour or smoke, discontinue use and contact an LG Electronics customer information centre.
- Only qualified technicians or service personnel from LG Electronics may disassemble, repair or modify the appliance.
- Never insert a sharp metallic object such as a pin, nail or knife in a hole or gap in the appliance or the charging station.
- Do not vacuum liquids with this appliance. Make sure that no water, beverage or detergent gets inside the appliance or the charging station.
- Do not allow the appliance to sweep up blades, thumb tacks, sawdust, sharp objects, or hot or cold ashes.
- Do not allow children to use the appliance.
- Do not let children or pets get close to the appliance when using, charging or storing.
- Do not insert the nozzle or tools in your mouth.

- Keep clothing and hair, fingers, or other parts of the body away from openings and moving parts.
- Do not operate the appliance with the suction inlet or outlet blocked.
- Do not use the appliance without the dust bin and filters in place.
- Do not use in an enclosed space where vapors are present from paint thinner, mothproofing substances, flammable dust or other explosive or toxic materials.
- Do not touch the charging terminals on the appliance or the charging station, or insert an electrified object inside the appliance or the station.
- Always store the appliance on the floor standing or wall-mounted charging station when it is not in use.
- Do not lean the appliance on walls, chairs or tables.
- If the earth leakage breaker is tripped when the product is put on the charging station, immediately remove the appliance from the charging station. Contact an LG Electronics customer service centre.
- Use extra care when cleaning on stairs.
- Do not use or store a heating device or flammable substance(ether, benzene, alcohol, chemicals, combustible sprays, insecticide, air freshener or cosmetics) in close proximity to the appliance.
- Do not attempt to clean up a liquid substance (water, beverage), odorous substances (candy, chocolate, pet excrement), metallic objects (blades, pins), flammable substances, burning / smoking(cigarettes, matches, or hot ashes), surfactants, or glass shards with this appliance.
- In the event of a gas leak(natural gas, propane gas, etc.), do not operate this or any other appliance. Open a window or door to ventilate the area immediately.
- Do not hold the charging station upside down with the battery in the charging station.
- Do not expose the appliance, and the battery in particular, to heat, a heating device or direct sunlight.
- Do not keep the appliance or its battery inside a vehicle which is exposed to direct sunlight.
- Never allow any water, beverage or detergent to get inside the battery.
- Do not apply physical impacts to the battery.

Maintenance

- Make sure to unplug the power cord when cleaning or maintaining the charging station.
- Do not wash the inlet port or the dust bin with water or detergent.
- Do not use detergents, polishes or air fresheners to clean the dust bin.
- Do not apply or spray a flammable substance (gasoline or thinner) or surfactants (detergent or bath soap) on the appliance.
- Wash hands after handling nozzles. The nozzles contain carbon fiber, and contact may cause minor skin irritation.

Disposal

- Keep packing materials out of the reach of children. Packaging materials can pose a suffocation risk for children.
- Destroy the carton, plastic bag, and other packing materials after the appliance is unpacked. Children might use them for play. Cartons covered with rugs, bedspreads, or plastic sheets can become airtight chambers.
- Dispose of this appliance according to local, state, and regional laws and regulations.
- Contact your local city council or the related government authority before disposing of this appliance.

CAUTION

- To reduce the risk of injury to persons, malfunction, or damage to the product or property when using the appliance, follow basic safety precautions, including the following:
-

Operation

- This appliance has a built-in safety device to prevent damage from overheating. If the appliance becomes overheated after extended use, it may automatically turn off. If this occurs, leave the appliance in a cool, well-ventilated area for about an hour before turning on the power again.
- Do not subject the product to shocks or drop it.
- Do not install wet or damp filters.
- Always use a soft cloth to clean the appliance. Do not clean the product with a volatile or organic solvent (thinner or acetone).
- Do not clean the same spot repeatedly for an extended period of time. Doing so may damage the carpet or flooring surface.
- Keep fingers away from pinch points when assembling the appliance or the charging station.
- Do not use the double-sided tape to anchor the charging station on wallpaper. Use the provided screws to anchor the charging station. The weight of the charging station and the appliance could damage the paper.
- Do not apply force or any impact to the Cyclonic Mesh Filter.
- Do not remove the battery during operation.

INSTALLATION

Product Overview

The images in this guide may be different from the actual components and accessories, which are subject to change by the manufacturer without prior notice for product improvement purposes.

Front View

*1 This feature is only available on some models.

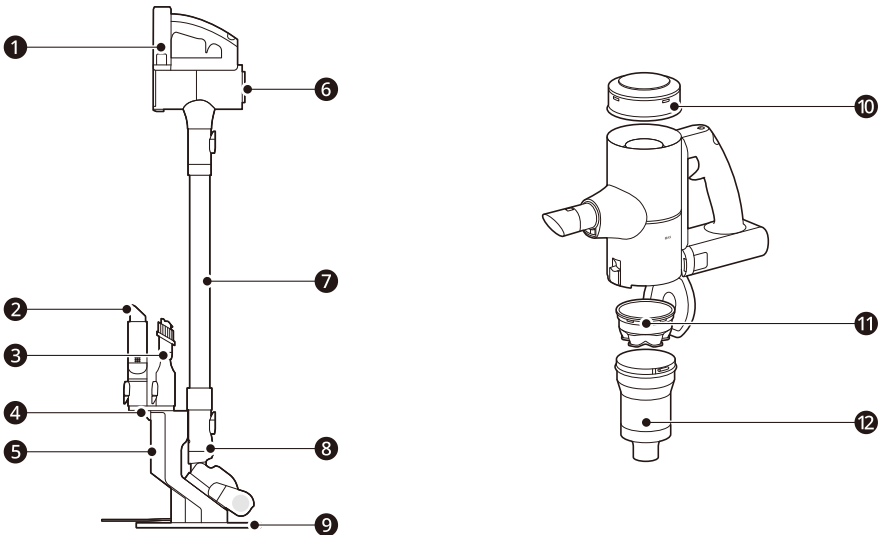

- ① Battery
- ② Crevice Tool
- ③ Combination Tool
- ④ Tool Holder
- ⑤ Charging Station
- ⑥ Product Body
- ⑦ Fixed Pipe
- ⑧ Nozzle
- ⑨ Charging Station Support
- ⑩ Exhaust Filter
- ⑪ Pre-filter
- ⑫ Cyclonic Mesh Filter

Accessories

Included Accessories

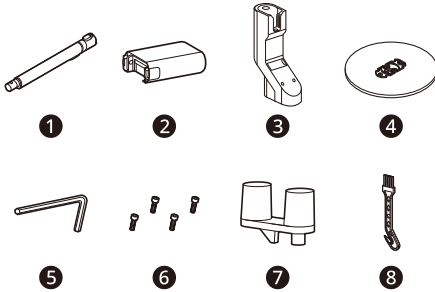

- ❶ Fixed Pipe
- ❷ Battery
- ❸ Charging Station
- ❹ Charging Station Support
- ❺ Allen Key
- ❻ Charging Station Screws
- ❼ Tool Holder
- ❽ Cleaning Brush

Basic Accessories

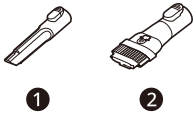

- ❶ Crevice Tool
- ❷ Combination Tool

Nozzles



- ❶ Hard Floor Power Drive Nozzle

Installation Kit

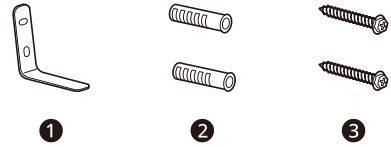

- ❶ 'L' Shaped Wall Mounting Bracket
- ❷ Wall Anchor
- ❸ Wall Set Screws

⚠ CAUTION

- The battery, exhaust filter and the pre-filter will eventually need to be replaced. Contact an LG Electronics customer service center.

Specifications

Appliance

Model	A9LSLIM	
Dimensions (Width X Depth X Height)	251 mm X 242 mm x 1026 mm	
Weight	Approximately 1.97 kg	
Power Consumption	250 W in Turbo Mode (Maximum 450 W) 100 W in Power Mode 55 W in Normal Mode	
Battery Run Time (Using one battery)	Using with the Nozzle Up to 6 minutes in Turbo Mode Up to 15 minutes in Power Mode Up to 30 minutes in Normal Mode	Using with the Tool Up to 7 minutes in Turbo Mode Up to 20 minutes in Power Mode Up to 40 minutes in Normal Mode

- Dimensions are given for the assembled product body, pipe and nozzle.
- Battery run time is the result of using a fully charged battery according to the LG Electronics test standard. Results may be different depending on actual use environment and period of use.

Power Supply unit

Model	ZD012M220075BS
Input	100 V - 240 V~, 50/60 Hz, 0.5 A
Output	DC 22.0V, 0.75A

Installing the Charging Station

Installing the Stand-type Charging Station

⚠ Warning

- Install the charging station on a level surface so that it does not tip over.
- Supervise children or pets to avoid the product and its charging station from tipping over.

⚠ Caution

- When assembling the product or charging station, be careful not to pinch your fingers.
- Be careful not to drop the accessories when taking them out of the packaging box.
- Use wall screws only for solid walls, such as concrete walls.

Be sure to follow the steps below for the charging station

1. Mount the charging station **4** to the charging station support **3**.
2. Use the included screws **2** and Allen Key **1** to assemble the charging station and charging station support.

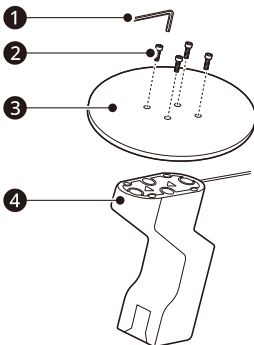

- Assemble according to the triangular assembly guide on the charging station and the charging station support.

⚠ Caution

- When assembling, be careful not to let the charging adapter wire get caught between the charging station and the charging station support.

Installing the Anti-Tip Bracket

The anti Tipping bracket helps prevent the product and its charging station from tipping over and causing damage or injury.

1. Before moving the product to its final location, select a suitable place to install the 「L」shaped wall mounting bracket.
 - The 「L」 shaped wall mounting bracket should be located right behind the product.
 - Place the charging station stand against the wall where it will be finally positioned and then align the L bracket to the top of the Charging base stand and the wall before marking out the two holes.

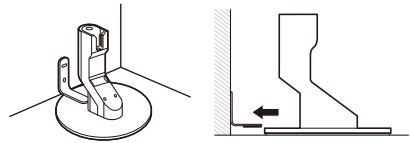

2. Drill 2 holes in the concrete wall at the selected location to insert the wall anchors. It is not recommended to secure the bracket to a Gyprock or plaster board wall as any impact or force to the bracket can damage the wall or its fixings.

- We recommend a wall hole diameter of 8.5 mm and a depth of 55 mm.
- NOTE: Make sure there are no pipes or wires inside the wall before drilling any holes.

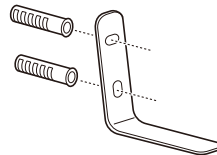

3. Use the wall set screws to fix the 「L」 shaped wall mounting bracket to the concrete wall.

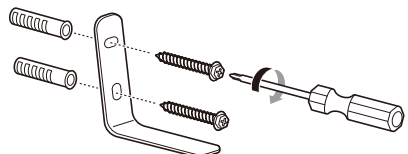

4. Slide the charging station support underneath the retaining bracket and connect the charging adaptor to the outlet.

Storing the accessories

Storing the Tools

Store the frequently used tools such as the combination tool and crevice tool attached to the charging station.

1. Insert Tool holder into the hole above the charging station.
 - The Tool holder can be assembled in 3 directions.

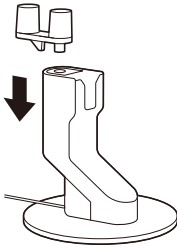

2. Insert the accessory tools into the holder.

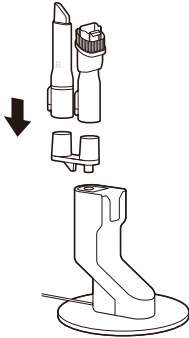

Assembling the Appliance

Follow these steps to safely assemble the appliance.

1. Assemble pipe ③ and floor Nozzle onto the main unit ①.
 - To remove the pipe, press and pull down the pipe release button ②.

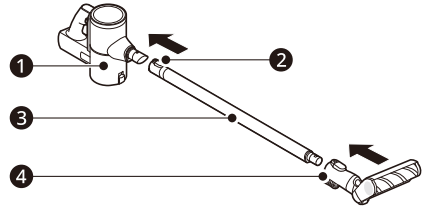

2. Align the product with the bottom groove ① of the charging station.
 - when the cleaner is successfully placed into the charging station it will emit an audible chime and the battery status bar will flash briefly. if the chime is not heard, then lift the cleaner from the charging station then lift it from the charging station and refit it again properly.

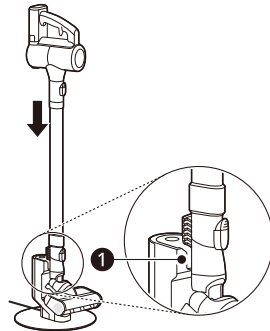

Charging the Battery

Before Charging the Battery

- Make sure that the adapter is connected to the power outlet.
- Fully charging a single battery usually takes 4 hours.
- The battery will not be charged if the indoor temperature is below 5 °C. Only charge the battery when indoor temperatures are between 5 °C and 38 °C.
- The battery will eventually need to be replaced. Due to the battery characteristics, runtime is shortened after using the appliance repeatedly for an extended period.

1. Press the power button to power off the product.
2. Align the product with the groove at the bottom of the charging station **1**.
 - Lower the cleaner into the charging station. When the cleaner is successfully placed into the charging station it will emit an audible chime and the battery status bar will flash briefly. If the chime is not heard, then lift the cleaner from the charging station then lift it from the charging station and refit it again properly.
 - When charging is complete, the battery level indicator **3** will turn off.

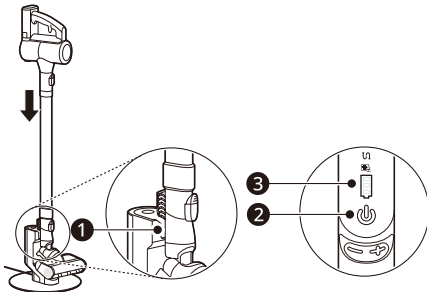

⚠ CAUTION

- Make sure to securely fit the product body onto the charging station. If the appliance falls off the charging station, it could cause injuries, property damage or product damage.

OPERATION

Getting Started

Before Using the Appliance

- Support the bottom of the appliance when cleaning an elevated surface.
- To avoid scratches on polished floors, keep tools and the brushes and rollers of the nozzles free from hair, grit, sand, or abrasive objects.
- Make sure that the exhaust filter or pre-filter is properly assembled before using the appliance.
- Close the dust bin cover properly before using the appliance. If the dust bin cover is left open, the suction strength may deteriorate and affect the cleaning results.
- Store the appliance in the charging station or place it flat on the floor when not in use. Leaning the appliance against a wall or chair can result in product damage or personal injury if the appliance falls.
- Environmental conditions such as temperature and humidity may cause static electricity to accumulate on the appliance. Please contact LG Electronics customer information centre if the problem persists.
- Make sure to remove any foreign object such as a sock or stocking before using the appliance. Any foreign object on the inlet port or extension pipe will prevent the appliance from functioning properly.
- Please use the product at normal room temperatures as the battery runtime may deteriorate severely if used at temperatures lower than 5 °C or higher than 38 °C for an extended period of time.
- The battery runtime is dependent on the surface type and the suction power.
- Follow manufacturer's recommendations when cleaning flooring, carpets, and rugs.
- Refer to the Specifications section for battery runtime details.

Assembling Attachments

Nozzles and tools can be attached to either the product body or the end of the fixed pipe.

1. Insert the fully charged battery ① into the cavity at the bottom of the handle on the product body and push the battery until it clicks.
 - If it is not properly inserted, the battery may fall out, causing product to malfunction or personal injury.

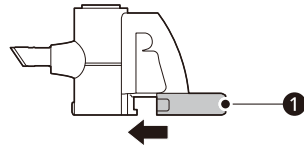

2. Attach the nozzles, tools, or fixed pipe by sliding them onto the inlet ② on the body until they click into place. The nozzles and tools can also be attached to the end of the fixed pipe ②.
 - Detach the accessories by pressing the release button ③.

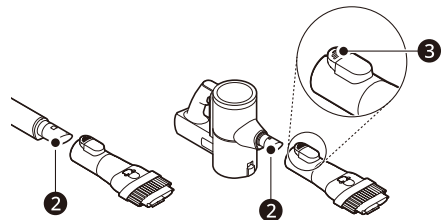

3. Press the **Power** button to activate the Normal mode.
 - To turn off the appliance, press the **Power** button again.

Operational Controls

Vacuum cleaner controls and status lights

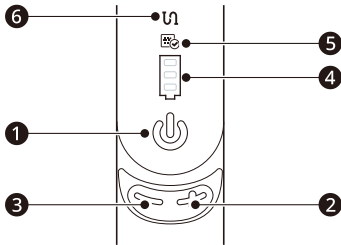

① Power Button

- Press the power button to power the cleaner on and off.
- When turned on, it operates in Normal mode.

② Increase suction (+) button

- Press the (+) button to increase suction power. The below 3 suction power modes are available. Normal → Power → Turbo mode.

③ Reduce suction (-) button

- When you press the (-) button, the suction power changes from Turbo → Power → Normal mode.

④ Battery level indicator

- The corresponding icon indicates the remaining battery capacity during use and also turns off when charging is complete.

⑤ Filter cleaning interval reminder light

- If you use the product for more than a certain amount of time, the icon will light up. Check the pre-filter, exhaust filter, and cyclonic mesh filter and clean if necessary.

⑥ Foreign matter clogging indicator lamp

- If the inside of the product, pipes, suction parts, inlets, pre-filters, exhaust filters, etc., are blocked by foreign objects, the icon will light up.
- If the foreign matter clogging persists, the appliance will switch off and a Foreign matter clogging notification will sound. Remove any debris that may be lodged in the pipe and clean the pre-filter, exhaust filter, and cyclonic mesh filter.

Using the Nozzles and Tools

Before Using the Nozzles and Tools

Some accessories are only available on some models.

Specialized attachments can help you clean more effectively. Tools and nozzles can be attached to the product body or the fixed pipe.

- Adjust the suction power if the inlet gets stuck on the floor, carpet, or bedding.
- Each Nozzle is equipped with a motor and may make a sound when operating.

⚠ CAUTION

- Do not use the Floor Power Nozzle on PVC or polyurethane mats for infants and children. The mat may stick to the nozzle, making it difficult to operate, causing damage to the mat or static electricity on the appliance. Clean mats using the crevice tool.

Floor Power Drive Nozzle

Use the Floor power nozzle for hard floors. it is not suitable for mats rugs or carpets.

- Do not push the 'PUSH' button on the Floor power nozzle during use as the rotating brush will detach and may cause damage or injury. It should only be pressed for cleaning purposes and when the nozzle is detached from the cleaner.

Crevice Tool

Use this tool to remove dust from corners or narrow spaces.

- Use it for areas with static electricity such as mats.
- Use it with the **Turbo** mode to clean pet hair out of furniture, mats, or tight areas like corners.

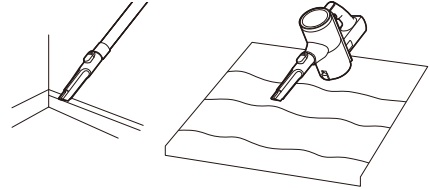

Combination Tool

Can be used in either crevice mode or brush mode for cleaning corners or small gaps where dust and dirt gather.

• Crevice Mode

Use the tool in the crevice mode to clean flat surfaces such as sofas or mattresses.

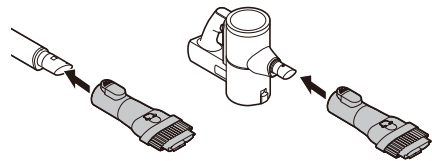

• Brush Mode

Use the tool in the brush mode to clean delicate surfaces such as frames or furniture.

- To convert modes, press the adjustment button ① and push forward.

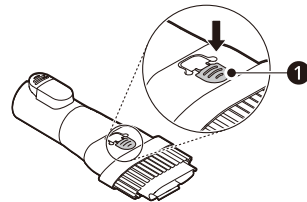

MAINTENANCE

Cleaning the Appliance

Before Cleaning the Appliance

To maintain the optimum suction power, the cyclonic mesh filter, the exhaust filter and the pre-filter should be cleaned regularly and washed under running water at least once a month.

- Turn off the power before cleaning the appliance.
- The frequency of cleaning varies depending on the usage environment and usage time. In a dusty environment, clean frequently.

⚠ WARNING

- Never wash the nozzle, rotating brush or product body with water. Water could reach the motor and cause electric shock or fire.
- Do not allow foreign objects to enter the motor. Doing so may cause electric shock, fire or product damage.
- Do not insert fingers or sharp objects into the motor. Doing so could cause product damage, personal injury or electric shock.

⚠ CAUTION

- Do not apply force or allow impacts to the cyclonic mesh filter. Doing so could deform the filter, compromise product performance, or cause the product to malfunction.

Removing Foreign Objects

In order to maintain product performance, be sure to remove any foreign objects and dust from inside the product body, fixed pipe or air inlets.

- Foreign materials inside the product can cause the product to be noisy, have poor suction, or shut down during operation.
- If the inside of the product body, fixed pipe, inlets, pre-filter, or exhaust filter is clogged with foreign objects, the power will surge

(alternating from Hi to Lo power) a few times to alert you to the blocked airflow. The appliance will then automatically turn off to prevent damage.

Separate the battery from the product body and remove the foreign objects before resuming use of the appliance.

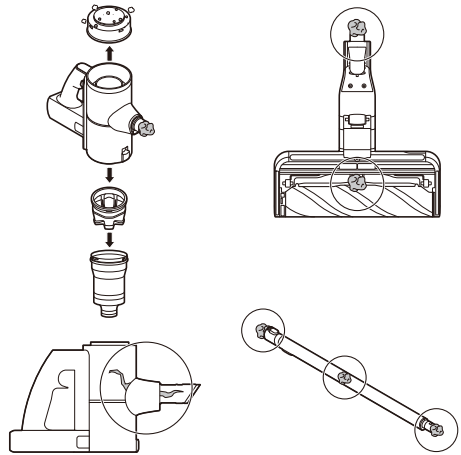

Cleaning the Dust Bin

Empty and clean the dust bin after every use.

- If the dust bin is completely full of dust or the filter is clogged, the suction power may be reduced.

1. Remove the battery from the body of the product before cleaning.
2. Press the dust bin cover release button ① to open the dust bin cover and empty the dust bin.

- Empty the dust bin into a larger waste bin.
- For less dust, the dust bin can first be emptied into a plastic or paper bag before disposing of the bag into a waste bin.

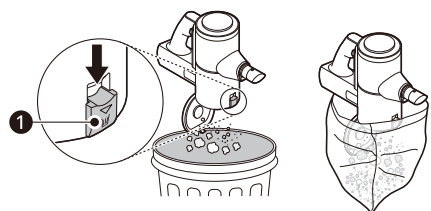

3. Rotate the cyclonic mesh filter **2** counter-clockwise to detach it.

- When the cyclonic mesh filter is removed, the pre-filter **3** should be attached to the cyclonic mesh filter. If it is not attached with the cyclonic mesh filter then, check the inside of the vacuum cleaner and take it out by hand.

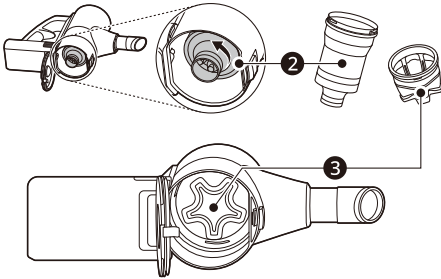

4. Remove dust from the cyclonic mesh filter and pre-filter and wash with water at least once a month.

- If there is any stubborn dust left in the cyclonic mesh filter, soak it in lukewarm water (about 40°C) for 30 minutes and then gently clean it with a brush before rinsing it again.
- Never tap or hit the cyclonic mesh filter against any surface as it will damage.
- Allow all the filters to dry in a well-ventilated area out of direct sunlight for at least 24 hours before reassembling.
- Any remaining moisture or undried filters may cause odour or severe damage to the suction motor.

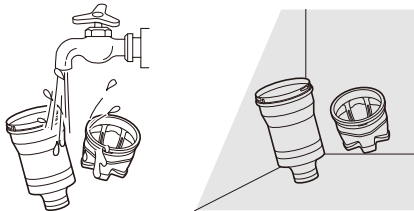

5. Use the cleaning brush **4** to remove the dust inside the dust bin.

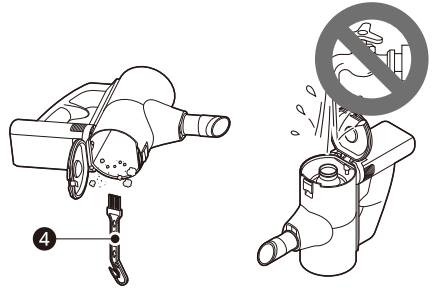

WARNING

- Never wash the product body with water. Water could reach the motor and cause electric shock or fire.
- Do not use the product body to suck up oils or any liquids, including water.
- Do not use the appliance without the Cyclonic Mesh Filter installed. Doing so could damage the product.
- Do not insert fingers or sharp objects into the motor to avoid product damage, personal injury, or electric shock.
- Do not allow foreign objects to reach the motor to avoid product damage, explosion or fire.

CAUTION

- Do not apply force or allow impacts to the Cyclonic Mesh Filter. Doing so could deform the filter, compromise product performance, or cause the product to malfunction.

Cleaning the exhaust filter

1. Remove the battery from the product body.
2. Rotate exhaust filter **1** counterclockwise to the open position **2** and remove it from the product body.

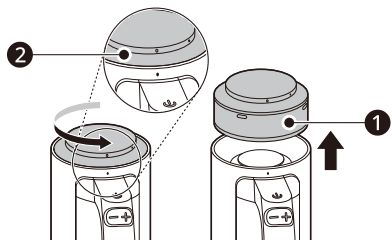

3. Use the cleaning brush **3** to clean the dust from the motor exhaust area.

- To prevent fire or permanent product damage, do not wash the body of the product with water as the suction motor is directly under the filter.

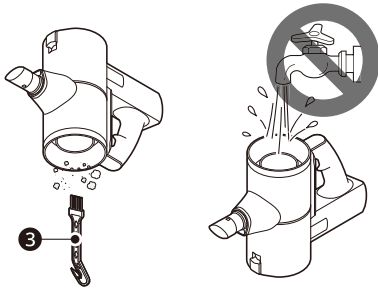

4. Dust off the filter and wash with water at least once a month.

- After washing the filter with water, allow it to dry completely in a well-ventilated area out of direct sunlight for at least 24 hours before reassembling. Any remaining moisture may cause odor or damage to the motor.



5. Align the exhaust filter to the open position and rotate clockwise to the locked position **4** to assemble it onto the product body.

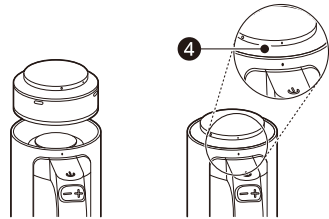

⚠ CAUTION

- Do not use the appliance without the exhaust filter installed. Doing so could result in product damage.

Cleaning the Nozzles

Clean the nozzle and rotating brush regularly.

⚠ CAUTION

- Always separate the nozzle from the product body or remove the battery before cleaning. If the nozzle starts to operate during cleaning, it could cause an injury.
- Keep fingers away from pinch points when assembling the nozzle on the appliance or the rotating brush on the nozzle.
- Do not use the rotating brush as a wet mop. It may cause product damage.
- Do not rinse or submerge the rotating brush or nozzle in water. It may cause product damage.

Cleaning the Slim Hard Floor Nozzle

1. Press the nozzle's release button **1** to disconnect the nozzle from the pipe or product body.

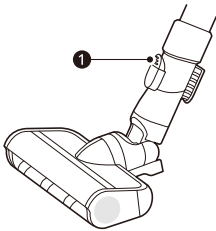

2. Turn the nozzle upside down and remove the rotating brush while holding down the PUSH button on the nozzle.

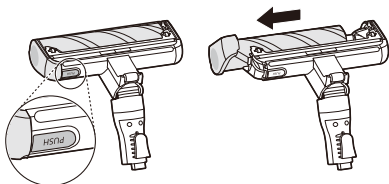

3. Attach the crevice tool to the product body and use the vacuum to remove foreign objects and dust from the brush and the bottom of the nozzle.

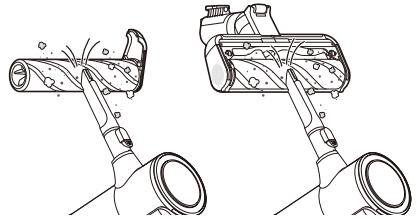

4. Use a damp towel or cloth to remove any remaining foreign objects and dust from the brush and the bottom of the nozzle. Remove foreign objects, debris and hair from all Rollers of the nozzles using tweezers.

- Wrap the handle of a long thin screwdriver with a wet towel or cloth and use it to clean the rotating brush and nozzle.

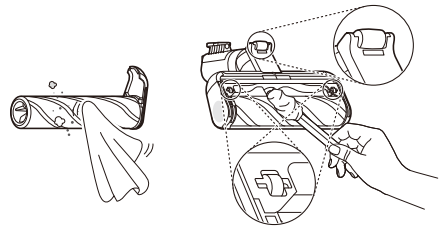

5. Slide the brush back into the nozzle until it clicks into place.

TROUBLESHOOTING

Before Calling for Service

Operation

Symptom	Causes and Solutions
The appliance does not operate.	Battery is fully discharged. <ul style="list-style-type: none"> Charge the battery.
	Appliance is turned off. <ul style="list-style-type: none"> Press the Power button to turn on the appliance.
Suction power is too weak.	Dust bin is full of dust. <ul style="list-style-type: none"> Empty the dust bin.
	Filters are clogged. <ul style="list-style-type: none"> Clean the pre-filter and the exhaust filter.
	Inlet is clogged. <ul style="list-style-type: none"> Remove any foreign objects from inside the product body or the fixed pipe.
	Foreign object is on rotating brush, or in inlet port. <ul style="list-style-type: none"> Remove any foreign objects (thread, hair) from the rotating brush or the inlet port.
The product body does not appear to be charging.	Power cord is unplugged. <ul style="list-style-type: none"> Plug the power cord securely into the outlet.
	Foreign object is on the charging terminals. <ul style="list-style-type: none"> Remove dirt or foreign objects from the charging terminals with a dry cloth.
Hot air is coming from the product body.	Motor is cooling. <ul style="list-style-type: none"> If the appliance is running normally, the hot air is a result of the motor cooling and is not a sign of malfunction.
A strange odour is coming from the appliance.	Appliance was purchased within the last 3 months. <ul style="list-style-type: none"> The cleaner may emit a smell of rubber for about 3 months after purchase.
	Dust bin is full of dust. <ul style="list-style-type: none"> The dust in the bin may cause some odour. Empty the bin and clean it.
	Foreign object is on the filter. <ul style="list-style-type: none"> The filter may emit an odour if it has not been cleaned for some time. Clean the pre-filter and exhaust filter regularly.

Symptom	Causes and Solutions
<p>A strange odour is coming from the appliance.</p>	<p>Pre-filter, Fine dust filter or the Cyclonic Mesh Filter were installed while damp or wet.</p> <ul style="list-style-type: none"> Wash the filters with running water. To avoid odour, allow the pre-filter to dry completely in a well-ventilated area out of direct sunlight for at least 24 hours before reassembling.
	<p>Exhaust filter was installed while damp or wet.</p> <ul style="list-style-type: none"> Wash the exhaust filter with running water. To avoid odour, allow the exhaust filter to dry completely in a well-ventilated area out of direct sunlight for at least 24 hours before reassembling.
<p>The appliance makes too much noise.</p>	<p>Vacuum cleaner is running in Turbo mode.</p> <ul style="list-style-type: none"> The motor may be louder at the higher suction power settings. This is normal.
<p>The appliance turns off unexpectedly or by itself after the motor speed fluctuates repeatedly.</p>	<p>Battery is not fully charged.</p> <ul style="list-style-type: none"> The battery must be fully charged before cleaning. If the problem persists when the battery is fully charged and the fixed pipe and attachments are clear from obstructions, contact an LG customer information centre for service.
	<p>Foreign object is in the product body, fixed pipe, inlet port or nozzle.</p> <ul style="list-style-type: none"> Remove any foreign objects from the product body, fixed pipe, inlet port or nozzle.
	<p>Filters are clogged.</p> <ul style="list-style-type: none"> Clean the pre-filter and the exhaust filter.
<p>The rotating brush does not rotate.</p>	<p>Brush is improperly installed.</p> <ul style="list-style-type: none"> Remove the brush, clean it if necessary and attach it again.
	<p>Foreign object is on rotating brush.</p> <ul style="list-style-type: none"> Remove any foreign objects from the rotating brush.

