



OWNER'S MANUAL

# AIR CONDITIONER

---



Read this owner's manual thoroughly before operating the appliance and keep it handy for reference at all times.

**TYPE: WALL MOUNTED**

EN ENGLISH

# TABLE OF CONTENTS

This manual may contain images or content that may be different from the model you purchased. This manual is subject to revision by the manufacturer.

<b>SAFETY INSTRUCTIONS .....</b>	<b>3</b>
IMPORTANT SAFETY INSTRUCTIONS .....	4
<b>NAMES OF PARTS.....</b>	<b>11</b>
Indoor Unit .....	11
Outdoor Unit .....	11
<b>INDOOR UNIT DISPLAY.....</b>	<b>12</b>
<b>EMERGENCY FUNCTION.....</b>	<b>13</b>
Emergency Function .....	13
<b>REMOTE CONTROLLER .....</b>	<b>14</b>
Using Wireless Remote Control.....	14
Replacement of Batteries.....	15
<b>OPERATING INSTRUCTIONS .....</b>	<b>16</b>
Cooling Mode .....	16
Auto Mode (auto changeover / auto operation mode) .....	16
Dry Mode .....	17
Heating Mode .....	17
Fan Mode.....	18
Fan Speed .....	18
Light Off.....	19
Jet Mode .....	19
Swing Control .....	20
Energy Saving .....	21
Dual Sensing .....	21
Room Temp .....	22
Change Celsius to Fahrenheit °C~°F .....	22
Setting the Current Time .....	22
Setting the On/Off Timer.....	23
Using the Sleep Function.....	24
Using Special Function .....	24
<b>PROTECTION.....</b>	<b>25</b>
<b>AUTO-RESTART FUNCTION .....</b>	<b>25</b>
Auto-Restart Function .....	25
<b>MAINTENANCE .....</b>	<b>26</b>
Air Filters .....	26
Cleaning the Heat Exchanger .....	26
End of Season Maintenance.....	26
<b>TROUBLESHOOTING .....</b>	<b>27</b>

The following safety guidelines are intended to prevent unforeseen risks or damage from unsafe or incorrect operation of the appliance. The guidelines are separated into 'WARNING' and 'CAUTION' as described below.



This symbol is displayed to indicate matters and operations that can cause risk. Read the part with this symbol carefully and follow the instructions in order to avoid risk.



## **WARNING**

This indicates that the failure to follow the instructions can cause serious injury or death.



## **CAUTION**

This indicates that the failure to follow the instructions can cause the minor injury or damage to the product.

The following symbols are displayed on indoor and outdoor units.



This symbol indicates that this appliance uses a flammable refrigerant. If the refrigerant is leaked and exposure to an external ignition source, there is a risk of fire.



This symbol indicates that the Operation Manual should be read carefully.



This symbol indicates that a service personnel should be handling this equipment with reference to the Installation Manual.



This symbol indicates that information is available such as the Operating Manual or Installation Manual.

## IMPORTANT SAFETY INSTRUCTIONS

### **WARNING**

**To reduce the risk of explosion, fire, death, electric shock, injury or scalding to persons when using this product, follow basic precautions, including the following:**

#### **Children in the Household**

- This appliance is not intended for use by persons (including children) with reduced physical, sensory or mental capabilities, or lack of experience and knowledge, unless they have been given supervision or instruction concerning use of the appliance by a person responsible for their safety. Children should be supervised to ensure that they do not play with the appliance.

#### **Installation**

- Do not install the air conditioner on an unstable surface or in a place where there is danger of it falling.
- Contact an authorized service center when installing or relocating the air conditioner.
- Install the panel and the cover of the control box safely.
- Do not install the air conditioner in a place where flammable liquids or gases such as gasoline, propane, paint thinner, etc., are stored.
- Make sure that the pipe and the power cable connecting the indoor and outdoor units are not pulled too tight when installing the air conditioner.
- Use standard circuit breaker and fuse that conform to the rating of the air conditioner.
- Do not input air or gas into the system except with the specific refrigerant.

- Use non-flammable gas (nitrogen) to check for leak and to purge air; using compressed air or flammable gas may cause fire or explosion.
- The indoor/outdoor wiring connections must be secured tightly, and the cable should be routed properly so that there is no force pulling the cable from the connection terminals. Improper or loose connections can cause heat generation or fire.
- Install dedicated electric outlet and circuit breaker before using the air conditioner.
- Do not connect the ground wire to a gas pipe, a lightning rod, or a telephone ground wire.
- Keep any required ventilation openings clear of obstruction.
- Means for disconnection must be incorporated in the fixed wiring in accordance with the wiring rules.
- Do not install the unit in potentially explosive atmospheres.

## **Operation**

- Be sure to use only those parts listed in the service parts list. Never attempt to modify the equipment.
- Make sure that children do not climb on or hit the outdoor unit.
- Dispose of the batteries in a place where there is no danger of fire.
- Use only the refrigerant specified on the air conditioner label.
- Cut off the power supply if there is any noise, smell, or smoke coming from the air conditioner.
- Do not leave flammable substances such as gasoline, benzene, or thinner near the air conditioner.
- Contact an authorized service center when the air conditioner is submerged by flood waters.
- Do not use the air conditioner for an extended period of time in a small place without proper ventilation.

- In the event of a gas leak (such as Freon, propane gas, LP gas, etc.) ventilate sufficiently before using the air conditioner again.
- Be sure to ventilate sufficiently when the air conditioner and a heating appliance such as a heater are used simultaneously.
- Do not block the inlet or outlet of air flow.
- Do not insert hands or other objects through the air inlet or outlet while the air conditioner is operating.
- Make sure that the power cable is neither dirty, loose, nor broken.
- Never touch, operate, or repair the air conditioner with wet hands.
- Do not place any objects on the power cable.
- Do not place a heater or other heating appliances near the power cable.
- Do not modify or extend the power cable. Scratches or peeling insulation on the power cables may result in fire or electric shock, and should be replaced.
- Cut off the power supply immediately in the event of a blackout or a thunderstorm.
- Take care to ensure that power cable could not be pulled out or damaged during operation.
- Do not touch refrigerant pipe, water pipe and any internal parts while the unit is operating or immediately after operation.

## **Maintenance**

- Do not clean the appliance by spraying water directly onto the product.
- Before cleaning or performing maintenance, disconnect the power supply and wait until the fan stops.

## Technical Safety

- Installation or repairs made by unauthorized persons can pose hazards to you and others.
- Any person who is involved with working on or breaking into a refrigerant circuit should hold a current valid certificate from an industry-accredited assessment authority, which authorizes their competence to handle refrigerants safely in accordance with an industry recognized assessment specification.
- Servicing shall only be performed as recommended by the equipment manufacturer. Maintenance and repair requiring the assistance of other skilled personnel shall be carried out under the supervision of the person competent in the use of flammable refrigerants.
- The information contained in the manual is intended for use by a qualified service technician who is familiar with the safety procedures and equipped with the proper tools and test instruments.
- Failure to read and follow all instructions in this manual can result in equipment malfunction, property damage, personal injury and/or death.
- The appliance shall be installed in accordance with national wiring regulations.
- When the power cord is to be replaced, the replacement work shall be performed by authorized personnel using only genuine replacement parts.
- This appliance must be properly grounded to minimize risk of electric shock.
- Do not cut or remove the grounding prong from the power plug.
- Attaching the earth wire to the power outlet cover screw does not ground the appliance unless the cover screw is metal, uninsulated, and the power outlet is grounded through house wiring.

- If you have any doubt whether the air conditioner is properly grounded, have the power outlet and circuit checked by a qualified electrician.
- The refrigerant and insulation blowing gas used in the appliance require special disposal procedures. Consult a service agent or a similarly qualified person before disposing of them.
- If the supply cord is damaged, it must be replaced by the manufacturer, its service agent or similarly qualified person in order to avoid a hazard.
- The appliance shall be stored in a well-ventilated area where the room size corresponds to the room area as specified for operation.
- The appliance shall be stored in a room without continuously operating open flames (for example an operating gas appliance) and ignition sources (for example an operating electric heater).
- The appliance shall be stored so as to prevent mechanical damage from occurring.

### CAUTION

**To reduce the risk of minor injury to persons, malfunction, or damage to the product or property when using this product, follow basic precautions, including the following:**

#### **Installation**

- Do not install the air conditioner in an area where it is directly exposed to sea wind (salt spray).
- Install the drain hose properly for the smooth drainage of water condensation.
- Exercise caution when unpacking or installing the air conditioner.

- Do not touch the leaking refrigerant during installation or repair.
- Transport the air conditioner with two or more people or use a forklift.
- Install the outdoor unit such that it is protected from direct sunlight. Do not place the indoor unit in a place where it is directly exposed to sunlight via the windows.
- Safely dispose of packing materials such as screws, nails, plastic bag or batteries using proper packaging after installation or repair.
- Install the air conditioner in a place where the noise from the outdoor unit or the exhaust fumes will not inconvenience the neighbors. Failure to do so may result in conflict with the neighbors.

## **Operation**

- Remove the batteries if the remote control is not to be used for an extended period of time.
- Make sure that the filter is installed before operating the air conditioner.
- Be sure to check if there is a refrigerant leak after installing or repairing the air conditioner.
- Do not place any object on the air conditioner.
- Never mix different types of batteries, or old and new batteries for the remote control.
- Do not let the air conditioner run for a long time when humidity is very high or when a door or a window has been left open.
- Stop using the remote control if there is a fluid leak in the battery. If your clothes or skin are exposed to the leaking battery fluid, wash off with clean water.
- Do not expose people, animals, or plants to the cold or hot wind from the air conditioner for extended periods of time.

- If the leaking battery fluid has been swallowed, rinse the inside of the mouth thoroughly and consult a doctor.
- Do not drink the water drained from the air conditioner.
- Do not use the product for special purposes, such as preserving foods, works of art, and etc. It is an air conditioner for consumer purposes, not a precision refrigeration system. There is risk of damage or loss of property.
- Do not recharge or disassemble the batteries.
- This appliance can be used by children aged from 8 years and above and persons with reduced physical, sensory or mental capabilities or lack of experience and knowledge if they have been given supervision or instruction concerning use of the appliance in a safe way and understand the hazards involved. Children shall not play with the appliance. Cleaning and user maintenance shall not be made by children without supervision.

## **Maintenance**

- Never touch the metal parts of the air conditioner when removing the air filter.
- Use a sturdy stool or ladder when cleaning, maintaining, or repairing the air conditioner at a height.
- Never use strong cleaning agents or solvents when cleaning the air conditioner or spray water. Use a smooth cloth.
- To clean the interior, contact an authorized service center or dealer. Using harsh detergents may cause corrosion or damage to the unit.

## Indoor Unit

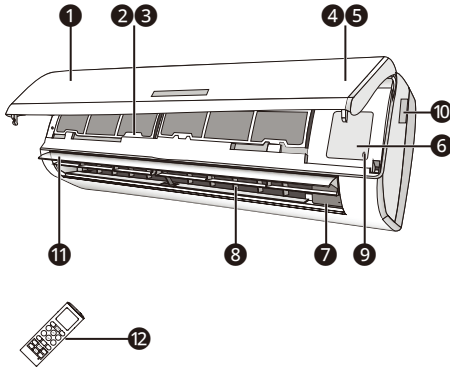

## Outdoor Unit

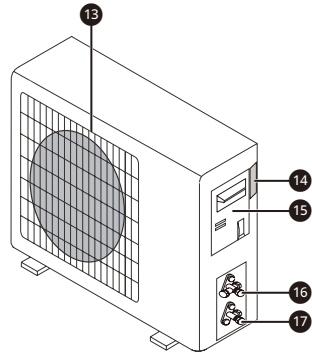

- ① Front panel
- ② Air filter
- ③ Optional filter (if installed)
- ④ LED Display
- ⑤ Signal receiver
- ⑥ Terminal block cover
- ⑦ Ionizer generator (if installed)
- ⑧ Deflectors
- ⑨ Emergency button
- ⑩ Indoor unit rating label
- ⑪ Airflow direction louver
- ⑫ Remote controller



- ⑬ Air outlet grille
- ⑭ Outdoor unit rating label
- ⑯ Terminal block cover
- ⑰ Gas valve
- ⑱ Liquid valve

### NOTE

- The above figures are only intended to be a simple diagram of the appliance and may not correspond to the appearance of the units that have been purchased.

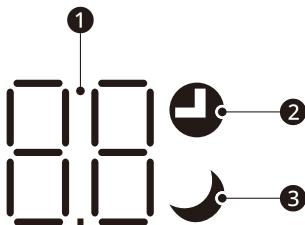
## Display



No.	LED	Function
①		Temperature display (if present)/Error code.
②		Lights up during Timer operation.
③		SLEEP mode.

### NOTE

- The shape and position of switches and indicators may be different according to the model, but their function is the same.

## Emergency Function

If the remote controller fails to work or maintenance necessary, proceed as follows:

Open and lift the front panel up to an angle to reach the emergency button.

- 1 One press of the emergency button (one beep) will lead to the forced COOLING operation.
- 2 Two press of the emergency button within 3 seconds (two beeps) will lead to the forced HEATING operation.
- 3 To switch off the unit, you just need to press the button again (a single long beep).
- 4 In forced operation, the air conditioner will automatically start working in 23 °C cooling/ Heating mode, auto fan speed.

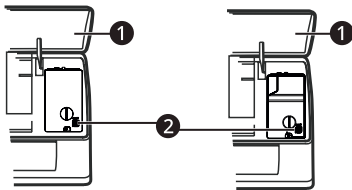

- 1 Front panel
- 2 Emergency button

## WARNING

- The shape and position of the emergency button may be different according to the model, but their function is the same.

## NOTE

- The external static pressure of heat pumps is 0 Pa for all models.
- The emergency button in some models could be on the right part of the unit under the front panel.

## Using Wireless Remote Control

You can operate the air conditioner more conveniently with the remote control.

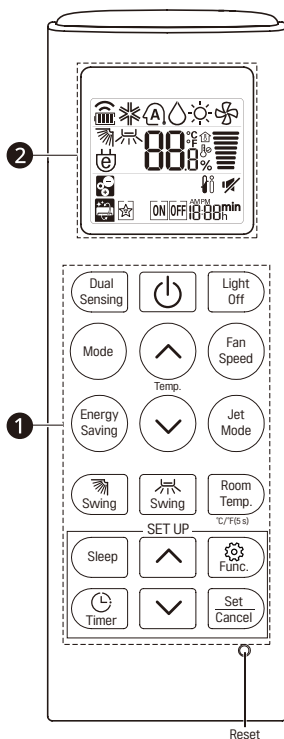

① Button	② Display Screen	Description
Dual Sensing		To set or cancel dual sensing mode operation.
	-	To turn On/Off the air conditioner.
Light Off	-	To turn On/Off the air conditioner indoor display.
Mode		To select the cooling mode.
		To select the auto changeover/auto operation mode.
		To select the dry mode.
		To select the heating mode.
		To select the fan mode.
Fan Speed		To adjust the fan speed.
Energy Saving		To minimize power consumption.
Jet Mode		To change room temperature quickly.
	88.8 <sup>°F</sup>	To adjust the desired room temperature in cooling, heating or auto mode. (16 °C ~ 31 °C)
Swing		To adjust the air flow direction vertically.
Swing		To adjust the air flow direction horizontally. (Optional)
Room Temp.		To display the room temperature.
Sleep		To set the sleeping mode automatically.
Func.		The Ion generator uses millions of ions to help improve indoor air quality. (Optional)
		To remove moisture generated inside the indoor unit.
Timer		To turn on/off air conditioner automatically at desired time.
Set/Cancel	-	To set/cancel the special functions and timer.
	-	To adjust time.
°C/°F(5 s)		To change unit between °C and °F

## Replacement of Batteries

When : There is no confirmation beep heard from the indoor unit. The LCD doesn't act.

Remove the battery cover plate from the rear of the remote controller, by sliding it in the direction of the arrow.

Install the batteries according the direction (+ and -) shown on the Remote Controller.

Reinstall the battery cover by sliding it into place.

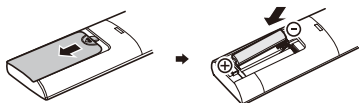

### **!** WARNING

- Use 2 LR03 AAA (1.5V) batteries. Do not use rechargeable batteries. Replace the old batteries with new ones of the same type when the display is no longer legible.
- Do not dispose batteries as unsorted municipal waste. Collection of such waste separately for special treatment is necessary.

### NOTE

- Please remove batteries to avoid leakage damage when not using for a long time.

### NOTE

- Direct the remote controller toward the air conditioner.
- Check that there are no objects between the remote control and the signal receptor in the indoor unit.
- Never leave the remote controller exposed to the rays of the sun.
- Keep the remote controller at a distance of at least 1 m from the television or other electrical appliances.

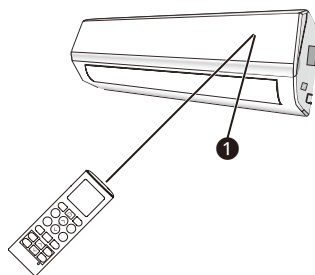

- ① Signal receptor

## Cooling Mode

The cooling function allows the air conditioner to cool the room and at the same time reduces air humidity.

To activate the Cooling mode of operation, press the **Mode** button on the remote controller until the symbol ☼ appears on the display.

The cooling function is activated by setting the button ☺ or ☹ at a temperature lower than that of the room.

To optimize the function of the air conditioner, adjust the temperature ❶, the speed ❷ and the direction of the air flow ❸ by pressing the buttons indicated.

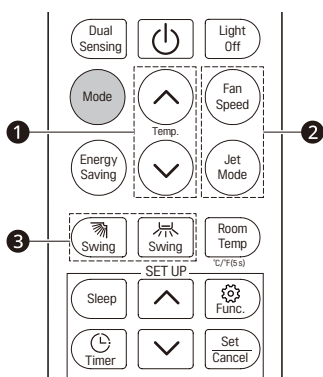

## Auto Mode (auto changeover / auto operation mode)

In **Auto** mode, the air conditioner will run automatically according to the room temperature.

To activate the Auto mode of operation, press the **Mode** button on the remote controller until the symbol ☼ appears on the display.

To optimize the function of the air conditioner, adjust the temperature ❶, the speed ❷ and the direction of the air flow ❸ by pressing the buttons indicated.

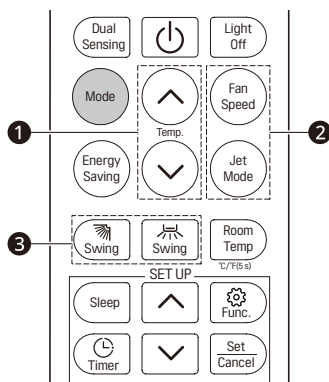

## Dry Mode

This function reduces the humidity of the air to make the room more comfortable.

To activate the Dry mode of operation, press the **Mode** button on the remote controller until the symbol  appears in the display.

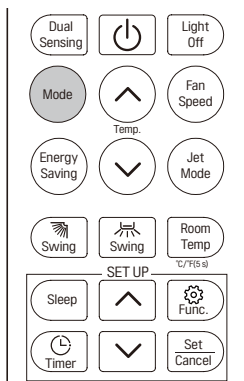

An automatic function of alternating cooling cycles and air fan is activated.



## Heating Mode

The heating function allows the air conditioner to heat the room.

To activate the Heating mode of operation, press the **Mode** button on the remote controller until the symbol  appears on the display.

With the button  or  set a temperature higher than that of the room.

To optimize the function of the air conditioner, adjust the temperature **1**, the speed **2** and the direction of the air flow **3** by pressing the buttons indicated.

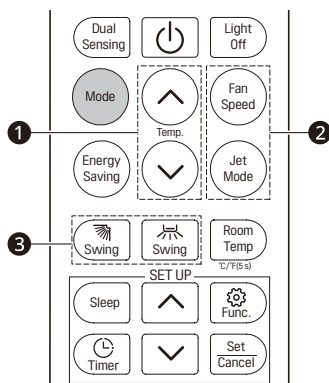

## Fan Mode

The air conditioner works in only ventilation.

To activate the Fan mode of operation, press the **Mode** button on the remote controller until the symbol  appears in the display.

To optimize the function of the air conditioner, Adjust the speed ❶ and the direction of the air flow ❷ By pressing the buttons indicated.

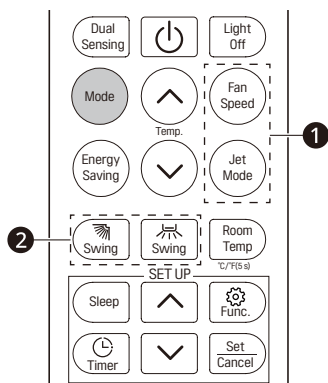









## Fan Speed

### Adjusting the Fan Speed

- Press **Fan Speed** button repeatedly to adjust the fan speed.

### Fan speed indicator

Display Screen	Speed
	Auto
	Jet
	High
	Mid-high
	Mid
	Low-mid
	Low
	Super Low

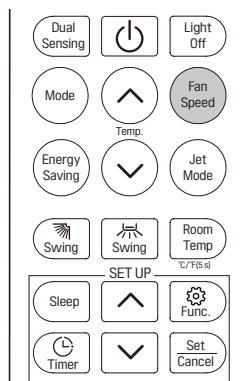

## Light Off

Switch on/off the LED display on panel.

To turn off the panel display, press **Light Off** button.

To turn on the panel display again, press **Light Off** button.

If the indoor display is set to OFF, pressing a button on the remote control automatically turns the display on for 15 seconds.

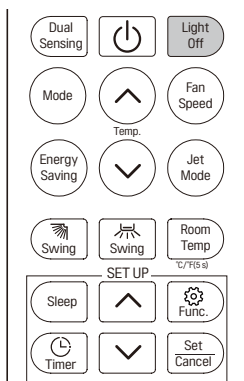

### NOTE

- LED turned off except  icon.

## Jet Mode

To activate Jet Mode function, pressing the button **Jet Mode** or pressing the button **Fan Speed** until  appears on the display.

To cancel this function, pressing the **Fan Speed** to switch other fan speed or pressing the **Jet Mode** button again.

In Cooling / Auto / Heating / Fan mode, when you select Jet Mode feature, it will use the highest fan setting to blow strong airflow.

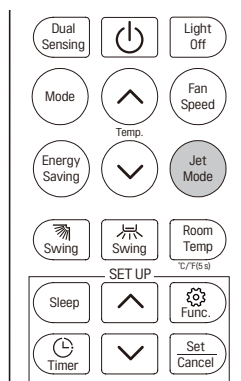

## Swing Control

### Vertically Swing

Press the button to activate the "Vertically Swing".

- If press time interval is in 2 seconds, the swing will cycle as below:



- If long press the button, the swing angle range will cycle as below:



### Horizontally Swing

Press the button to activate the "Horizontally Swing".

- If press time interval is in 2 seconds, the swing will cycle as below:



- If long press the button, the swing angle range will cycle as below:



### NOTE

- Adjusting the air flow direction horizontally may not be supported, depending on the model.
- Adjusting the air deflector arbitrarily may cause product failure.
- Never position manually, the delicate mechanism might seriously damaged! (Models without Horizontally Swing can adjust manually.)
- Never poke fingers, sticks or other objects in the air inlet or outlet vents. Such accidental contact might cause unforeseeable damage or hurt.
- Adjusting the swing angle change may not be supported, depending on the model.

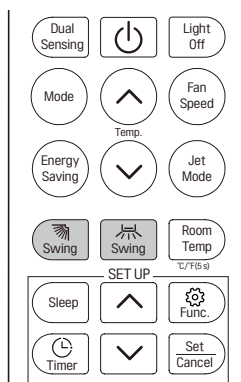

## Energy Saving

In this mode the appliance automatically sets the operation to achieve energy savings.

- 1 Turn on the appliance and select a Cooling, Heating mode.
- 2 Press the **“Energy Saving”** button, the appliance will run in Energy Saving mode.
- 3 Pressing the **“Energy Saving”** button again will cancel the mode, symbol ☺ will no longer be shown on the LCD screen.

In Energy Saving mode, the temperature ❶, the speed ❷ and the direction of the air flow ❸ can be adjusted by pressing the buttons indicated.

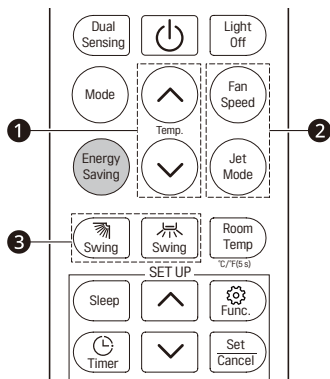

## Dual Sensing

Press the **“Dual Sensing”** button, the appliance will run in Dual Sensing mode.

Pressing the **“Dual Sensing”** button again will cancel the mode, symbol ☺ will no longer be shown on the LCD screen.

This function enable the remote control to measure the temperature at its current location and send this signal 7 times in 2 hours to the air conditioner to enable the air conditioner to optimize the temperature around you and ensure maximum comfort.

It will automatically deactivate 2 hours later.

In Dual sensing mode, the temperature ❶, the speed ❷ and the direction of the air flow ❸ can be adjusted by pressing the buttons indicated.

Advice to put the remote controller in the place where the indoor unit receive signal easily.

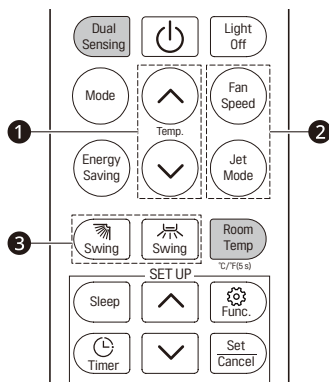

## Room Temp

Room temperature is displayed about 5 seconds if you press **Room Temp.** button.

## Change Celsius to Fahrenheit °C~°F

Press **Room Temp.** button for 5 seconds.

- Repeat the same process to change again.

## Setting the Current Time

- 1 Insert batteries (reinsert a battery if already inserted/or use the reset button).
  - The icon below blinks at the bottom of the display screen.



- 2 Press  or  button to select the time.
- 3 Press **Set/Cancel** button to finish.

### NOTE

- The On/Off Timer is available after setting the current time.



## Setting the On/Off Timer

This function sets the air conditioner to turn on/off automatically at desired time.

### Setting the On Timer

- 1 Press  button.
  - The icon below blinks at the bottom of the display screen.



- 2 Press  or  button to select the minutes.
- 3 Press **Set/Cancel** button to finish.
  - After setting the timer, current time and  icon are displayed on the display screen indicating that the desired time is set.

### Canceling the On Timer

- 1 Press  button.
  - The icon below blinks at the bottom of the display screen.





- 2 Press **Set/Cancel** button to finish.

## Setting the Off Timer

- 1 Press  button.
  - The icon below blinks at the bottom of the display screen.



- 2 Press  or  button to select the minutes.
- 3 Press **Set/Cancel** button to finish.
  - After setting the timer, current time and  icon are displayed on the display screen indicating that the desired time is set.

### Canceling the Off Timer

- 1 Press  button.
  - The icon below blinks at the bottom of the display screen.



- 2 Press **Set/Cancel** button to finish.

#### NOTE

- On/Off Timer can not be set together.
- On Timer is available when the product is turned off.
- Off Timer is available when the product is turned on.

## Using the Sleep Function

- 1 Turn the appliance on.
- 2 Press **Sleep** button.
  - The icon below blinks at the bottom of the display screen.





- 3 Do it again to deactivate this function.
  -  is displayed on the display screen.

### NOTE

- After 10 hours running in sleep mode, the air conditioner will return to the previous setting mode.

## Using Special Function

- 1 Turn the appliance on.
- 2 Press  button repeatedly to select the desired function.
- 3 Press **Set/Cancel** button to finish.
- 4 Do it again to deactivate this function.

Display Screen	Description
	To remove moisture generated inside the indoor unit.
	The Ion generator uses millions of ions to help improve indoor air quality.

### Auto Clean

In the Cooling and Dehumidification Mode, moisture is generated inside the indoor unit. This function removes such moisture.

This function enable the air conditioner still blow airflow about 15 minutes to dry the indoor inner parts to avoid mildew, when the air conditioner is off.

### Air Purification (Optional)

These functions supply clean and fresh air by ion particles and the filter.

### NOTE

- Some functions may not be supported, depending on the model.
- Some functions may operate differently from the remote control display.

The air conditioner is programmed for comfortable and suitable living conditions, if it is used in abnormal conditions as below, certain safety protection features might come into effect.

## Fix air conditioner:

Temperature	MODE	
	Cooling operating	Heating operating
Room temperature	16 °C ~ 31 °C	-
Outdoor temperature	21 °C ~ 48 °C	-

## WARNING

- The unit does not operate immediately if it is turned on after being turned off or after changing the mode during operation. This is a normal self-protection action, you need wait for about 3 minutes.
- The capacity and efficiency are according to the test conducted at full-load operation.
- The highest speed of indoor fan motor and the maximum open angle of the flaps and deflectors are requested.

# AUTO-RESTART FUNCTION

## Auto-Restart Function

The appliance is preset auto-restart function by manufacturer. In case of a sudden power failure, the module memorizes the setting conditions before the power failure. When the power restores, the unit restarts automatically with all the previous settings preserved by the memory function.

Periodic maintenance is essential for keeping your air conditioner efficient.

Before carrying out any maintenance, disconnect the power supply by taking the plug out from the socket.

## Air Filters

- 1 Open the front panel following the direction of the arrow.

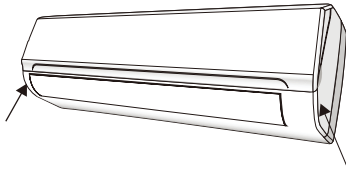

- 2 Keeping the front panel raised with one hand, take out the air filter with the other hand.

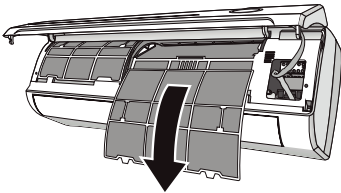
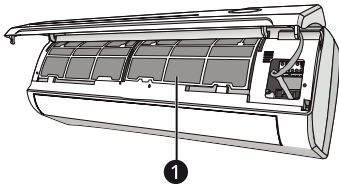

- 1 Air filter

- 3 Clean the filter with water; if the filter is soiled with oil, it can be washed with warm water (not exceeding 45 °C). Leave to dry in a cool and dry place.
- 4 Keeping the front panel raised with one hand, insert the air filter with the other hand.
- 5 Close.

## Cleaning the Heat Exchanger

- 1 Open the front panel of the unit and lift it till its greatest stroke and then unhooking it from the hinges to make the cleaning easier.
- 2 Clean the indoor unit using a cloth with the water (not higher than 40 °C) and neutral soap. Never use aggressive solvents or detergents.
- 3 If the outdoor unit is clogged, remove the leaves and the waste and remove the dust with air jet or a bit of water.

## End of Season Maintenance

- 1 Disconnect the automatic switch or the plug.
- 2 Clean and replace the filters.
- 3 On a sunny day let the conditioner work in ventilation for some hours, so that the inside of the unit can dry completely.

Please check the following before you contact the service center. If the problem persists, contact your local service center.

Malfunction	Possible Causes
<b>The appliance does not operate.</b>	Power failure/plug pulled out.
	Damaged indoor/outdoor unit fan motor.
	Faulty compressor thermomagnetic circuit breaker.
	Faulty protective device or fuses.
	Loose connections or plug pulled out.
	It sometimes stops operating to protect the appliance.
	Voltage higher or lower than the voltage range.
	Active TIMER-ON function.
Strange odour.	Damaged electronic control board.
Strange odour.	Air filter dirty.
Noise of running water.	Back flow of liquid in the refrigerant circulation.
A fine mist comes from the air outlet.	This occurs when the air in the room becomes very cold, for example in the "COOLING" or "DRY" modes.
A strange noise can be heard.	This noise is made by the expansion or contraction of the front panel due to variations in temperature and does not indicate a problem.
<b>Insufficient airflow, either hot or cold.</b>	Inappropriate temperature setting.
	Air inlet or outlet of indoor or outdoor unit has been blocked.
	Air filter is blocked.
	Fan speed set at minimum.
	Other sources of heat in the room.
<b>The appliance does not respond to commands.</b>	No refrigerant.
	Remote control is not near enough to indoor unit.
	Battery in remote controller may have been exhausted.
<b>The display is off.</b>	Obstacles between remote control and signal receiver in indoor unit.
	Press "Light Off" button.
	Power failure.

## WARNING

- Switch off the air conditioner immediately and cut off the power supply in the event of:
  - Strange noises during operation.
  - Faulty electronic control board.
  - Faulty fuses or switches.
  - Spraying water or objects inside the appliance.
  - Overheated cables or plugs.
  - Very strong smells coming from the appliance.

## Error Signals on the Display

In case of error, the display on the indoor unit shown the following error codes:

	<b>RUN lamp</b>	<b>Description of the trouble</b>
[H 01]	Flashes once	The fault of indoor temperature sensor.
[H 02]	Flashes twice	The fault of indoor pipe temperature sensor.
[H 10]	Flashes 6 times	Malfunction of indoor fan motor.
E4	Display code	Refrigerant leakage.

# Memo

# Memo

# Memo

