

INSTALLATION MANUAL

AIR CONDITIONER

Please read this installation manual completely before installing the product. Installation work must be performed in accordance with the national wiring standards by authorized personnel only. Please retain this installation manual for future reference after reading it thoroughly.

MULTI V™ IV
PRO



TIPS FOR SAVING ENERGY

Here are some tips that will help you to minimize the power consumption when you use the air conditioner. You can use your air conditioner more efficiently by referring to the instructions given below:

- Do not excessively cool indoors. This may be harmful for your health and may consume more electricity.
- Block sunlight with blinds or curtains while operating the air conditioner.
- Keep doors or windows closed tightly while operating the air conditioner.
- Adjust the direction of the air guide vane vertically or horizontally to circulate indoor air efficiently.
- Speed up the fan to cool or warm indoor air quickly, in a short period of time.
- Open windows regularly for ventilation as the indoor air quality may deteriorate if the air conditioner is used for many hours.
- Clean the air filter once every 2 weeks. Dust and impurities collected in the air filter may block the air flow or weaken the cooling / dehumidifying functions.

For your records

Staple your receipt to this page in case you need it to prove the date of purchase or for warranty purposes. Write the model number and the serial number here:

Model number : _____

Serial number : _____

Refer the label at side of each unit.

Dealer's name : _____

Date of purchase : _____

IMPORTANT SAFETY INSTRUCTIONS

READ ALL INSTRUCTIONS BEFORE USING THE APPLIANCE.

Always comply with the following precautions to avoid dangerous situations and ensure peak performance of your product

WARNING

It can result in serious injury or death when the directions are ignored

CAUTION

It can result in minor injury or product damage when the directions are ignored

WARNING

- Installation or repairs made by unqualified persons can result in hazards to you and others.
- The information contained in the manual is intended for use by a qualified service technician familiar with safety procedures and equipped with the proper tools and test instruments.
- Failure to carefully read and follow all instructions in this manual can result in equipment malfunction, property damage, personal injury and/or death.

Installation

- Have all electric work done by a licensed electrician according to "Electric Facility Engineering Standard" and "Interior Wire Regulations" and the instructions given in this manual and always use a special circuit.
 - If the power source capacity is inadequate or electric work is performed improperly, electric shock or fire may result.
- Ask the dealer or an authorized technician to install the air conditioner.
 - Improper installation by the user may result in water leakage, electric shock, or fire.
- Always ground the product.
 - There is risk of fire or electric shock.
- Always install a dedicated circuit and breaker.
 - Improper wiring or installation may cause fire or electric shock.
- For re-installation of the installed product, always contact a dealer or an Authorized Service Center.
 - There is risk of fire, electric shock, explosion, or injury.
- Do not install, remove, or re-install the unit by yourself (customer).
 - There is risk of fire, electric shock, explosion, or injury.
- Do not store or use flammable gas or combustibles near the air conditioner.
 - There is risk of fire or failure of product.
- Use the correctly rated breaker or fuse.
 - There is risk of fire or electric shock.
- Prepare for strong wind or earthquake and install the unit at the specified place.
 - Improper installation may cause the unit to topple and result in injury.
- Do not install the product on a defective installation stand.
 - It may cause injury, accident, or damage to the product.
- Use a vacuum pump or Inert(nitrogen) gas when doing leakage test or air purge. Do not compress air or Oxygen and do not use Flammable gases. Otherwise, it may cause fire or explosion.
 - There is the risk of death, injury, fire or explosion.

4 IMPORTANT SAFETY INSTRUCTIONS

- When installing and moving the air conditioner to another site, do not charge it with a different refrigerant from the refrigerant specified on the unit.
 - If a different refrigerant or air is mixed with the original refrigerant, the refrigerant cycle may malfunction and the unit may be damaged.
- Do not reconstruct to change the settings of the protection devices.
 - If the pressure switch, thermal switch, or other protection device is shorted and operated forcibly, or parts other than those specified by LGE are used, fire or explosion may result.
- Ventilate before operating air conditioner when gas leaked out.
 - It may cause explosion, fire, and burn.
- Securely install the cover of control box and the panel.
 - If the cover and panel are not installed securely, dust or water may enter the outdoor unit and fire or electric shock may result.
- If the air conditioner is installed in a small room, measures must be taken to prevent the refrigerant concentration from exceeding the safety limit when the refrigerant leaks.
 - Consult the dealer regarding the appropriate measures to prevent the safety limit from being exceeded. Should the refrigerant leak and cause the safety limit to be exceeded, hazards due to lack of oxygen in the room could result.

Operation

- Do not damage or use an unspecified power cord.
 - There is risk of fire, electric shock, explosion, or injury.
- Use a dedicated outlet for this appliance.
 - There is risk of fire or electrical shock.
- Be cautious that water could not enter the product.
 - There is risk of fire, electric shock, or product damage.
- Do not touch the power switch with wet hands.
 - There is risk of fire, electric shock, explosion, or injury.
- When the product is soaked (flooded or submerged), contact an Authorized Service Center.
 - There is risk of fire or electric shock.
- Be cautious not to touch the sharp edges when installing.
 - It may cause injury.
- Take care to ensure that nobody could step on or fall onto the outdoor unit.
 - This could result in personal injury and product damage.
- Do not open the inlet grille of the product during operation. (Do not touch the electrostatic filter, if the unit is so equipped.)
 - There is risk of physical injury, electric shock, or product failure.

 **CAUTION****Installation**

- Always check for gas (refrigerant) leakage after installation or repair of product.
 - Low refrigerant levels may cause failure of product.
- Do not install the product where the noise or hot air from the outdoor unit could damage the neighborhoods.
 - It may cause a problem for your neighbors.
- Keep level even when installing the product.
 - To avoid vibration or water leakage.
- Do not install the unit where combustible gas may leak.
 - If the gas leaks and accumulates around the unit, an explosion may result.
- Use power cables of sufficient current carrying capacity and rating.
 - Cables that are too small may leak, generate heat, and cause a fire.
- Do not use the product for special purposes, such as preserving foods, works of art, etc. It is a consumer air conditioner, not a precision refrigeration system.
 - There is risk of damage or loss of property.
- Keep the unit away from children. The heat exchanger is very sharp.
 - It can cause the injury, such as cutting the finger. Also the damaged fin may result in degradation of capacity.
- When installing the unit in a hospital, communication station, or similar place, provide sufficient protection against noise.
 - The inverter equipment, private power generator, high-frequency medical equipment, or radio communication equipment may cause the air conditioner to operate erroneously, or fail to operate. On the other hand, the air conditioner may affect such equipment by creating noise that disturbs medical treatment or image broadcasting.
- Do not install the product where it is exposed to sea wind (salt spray) directly.
 - It may cause corrosion on the product. Corrosion, particularly on the condenser and evaporator fins, could cause product malfunction or inefficient operation.

Operation

- Do not use the air conditioner in special environments.
 - Oil, steam, sulfuric smoke, etc. can significantly reduce the performance of the air conditioner or damage its parts.
- Do not block the inlet or outlet.
 - It may cause failure of appliance or accident.
- Make the connections securely so that the outside force of the cable may not be applied to the terminals.
 - Inadequate connection and fastening may generate heat and cause a fire.
- Be sure the installation area does not deteriorate with age.
 - If the base collapses, the air conditioner could fall with it, causing property damage, product failure, or personal injury.
- Install and insulate the drain hose to ensure that water is drained away properly based on the installation manual.
 - A bad connection may cause water leakage.
- Be very careful about product transportation.
 - Only one person should not carry the product if it weighs more than 20 kg.
 - Some products use PP bands for packaging. Do not use any PP bands for a means of transportation. It is dangerous.
 - Do not touch the heat exchanger fins. Doing so may cut your fingers.
 - When transporting the outdoor unit, suspending it at the specified positions on the unit base. Also support the outdoor unit at four points so that it cannot slip sideways.

- Safely dispose of the packing materials.
 - Packing materials, such as nails and other metal or wooden parts, may cause stabs or other injuries.
 - Tear apart and throw away plastic packaging bags so that children may not play with them. If children play with a plastic bag which was not torn apart, they face the risk of suffocation.
- Turn on the power at least 6 hours before starting operation.
 - Starting operation immediately after turning on the main power switch can result in severe damage to internal parts. Keep the power switch turned on during the operational season.
- Do not touch any of the refrigerant piping during and after operation.
 - It can cause a burn or frostbite.
- Do not operate the air conditioner with the panels or guards removed.
 - Rotating, hot, or high-voltage parts can cause injuries.
- Do not directly turn off the main power switch after stopping operation.
 - Wait at least 5 minutes before turning off the main power switch. Otherwise it may result in water leakage or other problems.
- Auto-addressing should be done in condition of connecting the power of all indoor and outdoor units. Auto-addressing should also be done in case of changing the indoor unit PCB.
- Use a firm stool or ladder when cleaning or maintaining the air conditioner.
 - Be careful and avoid personal injury.
- Do not insert hands or other objects through the air inlet or outlet while the air conditioner is plugged in.
 - There are sharp and moving parts that could cause personal injury.

TABLE OF CONTENTS

2 TIPS FOR SAVING ENERGY

3 IMPORTANT SAFETY INSTRUCTIONS

8 INSTALLATION PROCESS

9 OUTDOOR UNITS INFORMATION

14 ENVIRONMENT-FRIENDLY ALTERNATIVE REFRIGERANT R410A

15 SELECT THE BEST LOCATION

16 INSTALLATION SPACE

16 Individual Installation

18 LIFTING METHOD

19 INSTALLATION

19 The location of the Anchor bolts

20 Foundation for Installation

21 Preparation of Piping

24 Plumbing materials and storage methods

26 REFRIGERANT PIPING INSTALLATION

26 Precautions on Pipe connection / Valve operation

27 PIPE CONNECTIONS BETWEEN INDOOR AND OUTDOOR UNIT

27 Preparation Work

28 Pipe Drawing Out during Single / Series connection

30 Refrigerant piping system

32 Pipe Connection Method between outdoor unit/indoor unit

41 Refrigerant charging

42 Distribution Method

43 Branch pipe Fitting

47 Leak Test and Vacuum drying

49 Vacuum Mode

50 Heat insulation of refrigerant piping

51 ELECTRICAL WIRING

51 CAUTION

53 Control box and connecting position of wiring

54 Communication and Power Cables

55 Wiring of main power supply and equipment capacity

56 Field Wiring

63 Checking the setting of outdoor units

64 Group Number setting

65 Automatic Addressing

68 Cool & Heat selector

69 Static pressure compensation mode

70 Night Low Noise Function

71 Overall defrost mode

72 Setting the ODU address

73 Snow removal & rapid defrost

74 Target pressure adjusting

75 High Efficiency cooling mode

76 Auto dust removal mode

77 Smart Load Control

78 Continuous Cooling Function

79 Self-Diagnosis Function

90 CAUTION FOR REFRIGERANT LEAK

90 Introduction

90 Checking procedure of limiting concentration

92 INSTALLATION GUIDE AT THE SEASIDE

INSTALLATION PROCESS

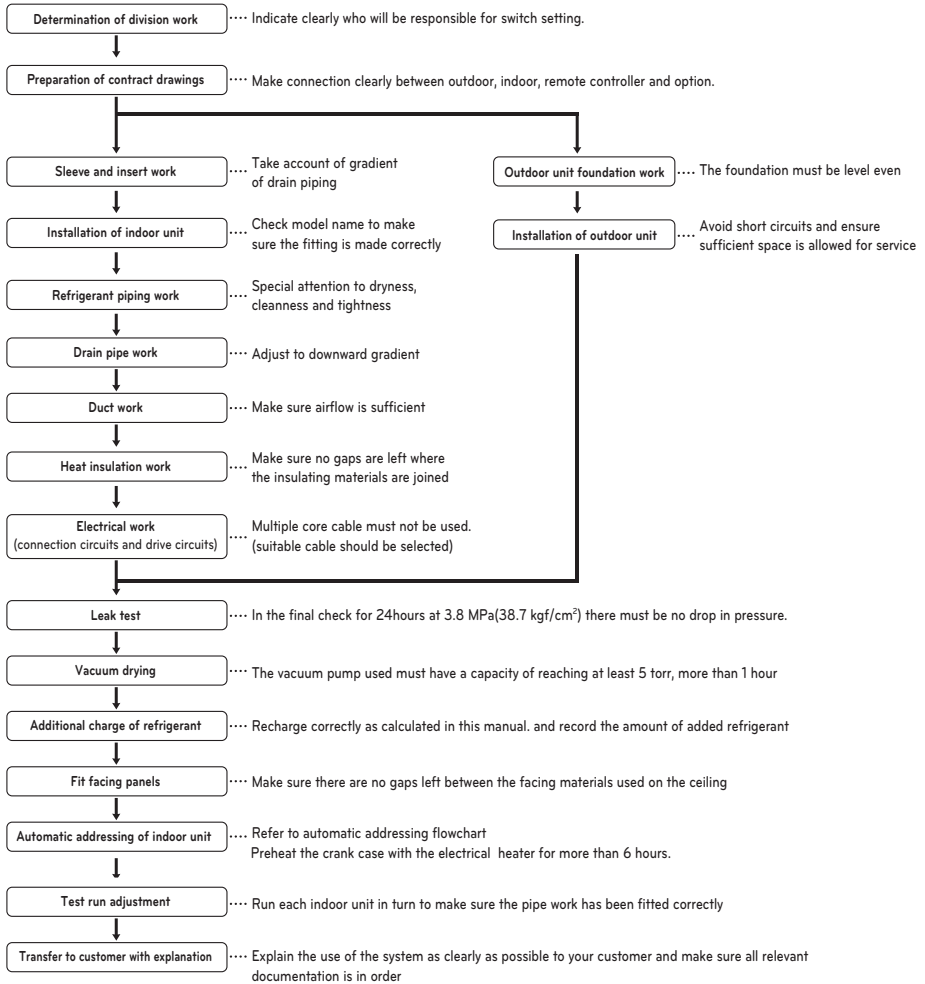

⚠ CAUTION

- The above list indicates the order in which the individual work operations are normally carried out but this order may be varied where local conditions warrants such change.
- The thickness of the piping should comply with the relevant local and national regulations for the designed pressure 3.8 MPa.
- Since R410A is a mixed refrigerant, the required additional refrigerant must be charged in its liquid state.(If the refrigerant is charged in its gaseous state, its composition changes and the system will not work properly.)

OUTDOOR UNITS INFORMATION

! CAUTION

■ Combination Ratio(50~200%)

Number of Outdoor units	Combination Ratio	
	Standard Model	Space Saving Model
Single Unit	200%	160% *
Two Units Combination	160%	120%
Three or More Units Combination	130%	120%

* A(C)RUN220LLN4 (Single Unit) model can guarantee the operation only within 160% combination ratio.

Notes :

- 1) We can guarantee the operation only within 130% combination ratio.
If you want to connect more than 130% combination ratio, please contact us and discuss the requirement.
- 2) In case that operating indoor units ratio to rated capacity of outdoor unit is more than 130%, the airflow should be operated as low step in the all indoor units.
- 3) In case of Space Saving Model (A(C)RUN***LLN4), we can recommend the operation within 120% combination ration for two or more combination.
- 4) The numbers in parentheses means maximum connectable indoor units in accordance with outdoor units combination.

Power Supply : 380V, 60Hz / 380 – 415V, 50Hz

Model Name : A(C)RUN*LLS4, A(C)RUN***LLN4**

■ Standard Model

Unit		1 Outdoor Unit			
System(HP)		8	10	12	14
Model	Combination Unit	A(C)RUN080LLS4	A(C)RUN100LLS4	A(C)RUN120LLS4	A(C)RUN140LLS4
	Independent Unit	A(C)RUN080LLS4	A(C)RUN100LLS4	A(C)RUN120LLS4	A(C)RUN140LLS4
Refrigerant Precharged Amount	kg	5.0	5.0	5.0	6.6
	lbs	11.0	11.0	11.0	14.6
Number of maximum connectable indoor units		13(20)	16(25)	20(30)	23(35)
Net Weight	kg	175 × 1	175 × 1	180 × 1	190 × 1
	lbs	386 × 1	386 × 1	397 × 1	419 × 1
Dimensions (WxHxD)	mm	(920 × 1,680 × 760) × 1	(920 × 1,680 × 760) × 1	(920 × 1,680 × 760) × 1	(920 × 1,680 × 760) × 1
	inch	(36-7/32 × 66-5/32 × 29-29/32) × 1	(36-7/32 × 66-5/32 × 29-29/32) × 1	(36-7/32 × 66-5/32 × 29-29/32) × 1	(36-7/32 × 66-5/32 × 29-29/32) × 1
Piping Connections	mm(inch)	Ø 9.52(3/8)	Ø 9.52(3/8)	Ø 12.7(1/2)	Ø 12.7(1/2)
	mm(inch)	Ø 19.05(3/4)	Ø 22.2(7/8)	Ø 28.58(1-1/8)	Ø 28.58(1-1/8)

Unit		1 Outdoor Unit		
System(HP)		16	18	20
Model	Combination Unit	A(C)RUN160LLS4	A(C)RUN180LLS4	A(C)RUN200LLS4
	Independent Unit	A(C)RUN160LLS4	A(C)RUN180LLS4	A(C)RUN200LLS4
Refrigerant Precharged Amount	kg	6.0	6.0	7.6
	lbs	13.2	13.2	16.8
Number of maximum connectable indoor units		26(40)	29(45)	32(50)
Net Weight	kg	205 × 1	245 × 1	255 × 1
	lbs	452 × 1	540 × 1	562 × 1
Dimensions (WxHxD)	mm	(1,240 × 1,680 × 760) × 1	(1,240 × 1,680 × 760) × 1	(1,240 × 1,680 × 760) × 1
	inch	(48-13/16 × 66-5/32 × 29-29/32) × 1	(48-13/16 × 66-5/32 × 29-29/32) × 1	(48-13/16 × 66-5/32 × 29-29/32) × 1
Piping Connections	mm(inch)	Ø 12.7(1/2)	Ø 15.88(5/8)	Ø 15.88(5/8)
	mm(inch)	Ø 28.58(1-1/8)	Ø 28.58(1-1/8)	Ø 28.58(1-1/8)

Unit		2 Outdoor Units			
System(HP)		22	24	26	28
Model	Combination Unit	A(C)RUN220LLS4	A(C)RUN240LLS4	A(C)RUN260LLS4	A(C)RUN280LLS4
	Independent Unit	A(C)RUN120LLS4 A(C)RUN100LLS4	A(C)RUN120LLS4 A(C)RUN120LLS4	A(C)RUN140LLS4 A(C)RUN120LLS4	A(C)RUN160LLS4 A(C)RUN120LLS4
Refrigerant Precharged Amount	kg	5.0 × 2	5.0 × 2	6.6 × 1 + 5.0 × 1	6.0 × 1 + 5.0 × 1
	lbs	11.0 × 2	11.0 × 2	14.6 × 1 + 11.0 × 1	13.2 × 1 + 11.0 × 1
Number of maximum connectable indoor units		35(44)	39(48)	42(52)	45(56)
Net Weight	kg	180 × 1 + 175 × 1	180 × 2	190 × 1 + 180 × 1	205 × 1 + 180 × 1
	lbs	397 × 1 + 386 × 1	397 × 2	419 × 1 + 397 × 1	452 × 1 + 397 × 1
Dimensions (WxHxD)	mm	(920 × 1,680 × 760) × 2	(920 × 1,680 × 760) × 2	(920 × 1,680 × 760) × 2	(1,240 × 1,680 × 760) × 1 + (920 × 1,680 × 760) × 1
	inch	(36-7/32 × 66-5/32 × 29-29/32) × 2	(36-7/32 × 66-5/32 × 29-29/32) × 2	(36-7/32 × 66-5/32 × 29-29/32) × 2	(48-13/16 × 66-5/32 × 29-29/32) × 1 + (36-7/32 × 66-5/32 × 29-29/32)
Piping Connections	mm(inch)	Ø 15.88(5/8)	Ø 15.88(5/8)	Ø 19.05(3/4)	Ø 19.05(3/4)
	mm(inch)	Ø 28.58(1-1/8)	Ø 34.9(1-3/8)	Ø 34.9(1-3/8)	Ø 34.9(1-3/8)

Unit		2 Outdoor Units			
System(HP)		30	32	34	36
Model	Combination Unit	A(C)RUN300LLS4	A(C)RUN320LLS4	A(C)RUN340LLS4	A(C)RUN360LLS4
	Independent Unit	A(C)RUN180LLS4 A(C)RUN120LLS4	A(C)RUN200LLS4 A(C)RUN120LLS4	A(C)RUN200LLS4 A(C)RUN140LLS4	A(C)RUN200LLS4 A(C)RUN160LLS4
Refrigerant Precharged Amount	kg	6.0 × 1 + 5.0 × 1	7.6 × 1 + 5.0 × 1	7.6 × 1 + 6.6 × 1	7.6 × 1 + 6.0 × 1
	lbs	13.2 × 1 + 11.0 × 1	16.8 × 1 + 11.0 × 1	16.8 × 1 + 14.6 × 1	16.8 × 1 + 13.2 × 1
Number of maximum connectable indoor units		49(60)	52(64)	55(64)	58(64)
Net Weight	kg	245 × 1 + 180 × 1	255 × 1 + 180 × 1	255 × 1 + 190 × 1	255 × 1 + 205 × 1
	lbs	540 × 1 + 397 × 1	562 × 1 + 397 × 1	562 × 1 + 419 × 1	562 × 1 + 452 × 1
Dimensions (WxHxD)	mm	(1,240 × 1,680 × 760) × 1 + (920 × 1,680 × 760) × 1	(1,240 × 1,680 × 760) × 1 + (920 × 1,680 × 760) × 1	(1,240 × 1,680 × 760) × 1 + (920 × 1,680 × 760) × 1	(1,240 × 1,680 × 760) × 2
	inch	(48-13/16 × 66-5/32 × 29-29/32) × 1 + (36-7/32 × 66-5/32 × 29-29/32)	(48-13/16 × 66-5/32 × 29-29/32) × 1 + (36-7/32 × 66-5/32 × 29-29/32)	(48-13/16 × 66-5/32 × 29-29/32) × 1 + (36-7/32 × 66-5/32 × 29-29/32)	(48-13/16 × 66-5/32 × 29-29/32) × 2
Piping Connections	mm(inch)	Ø 19.05(3/4)	Ø 19.05(3/4)	Ø 19.05(3/4)	Ø 19.05(3/4)
	mm(inch)	Ø 34.9(1-3/8)	Ø 34.9(1-3/8)	Ø 34.9(1-3/8)	Ø 41.3(1-5/8)

Unit		2 Outdoor Units		3 Outdoor Units	
System(HP)		38	40	42	44
Model	Combination Unit	A/C/RUN380LLS4	A/C/RUN400LLS4	A/C/RUN420LLS4	A/C/RUN440LLS4
	Independent Unit	A/C/RUN200LLS4	A/C/RUN200LLS4	A/C/RUN180LLS4	A/C/RUN200LLS4
		A/C/RUN180LLS4	A/C/RUN200LLS4	A/C/RUN140LLS4	A/C/RUN140LLS4
Refrigerant Precharged Amount	kg	7.6 x 1 + 6.0 x 1	7.6 x 2	6.0 x 1 + 6.6 x 1 + 5.0 x 1	7.6 x 1 + 6.6 x 1 + 5.0 x 1
	lbs	16.8 x 1 + 13.2 x 1	16.8 x 2	13.2 x 1 + 14.6 x 1 + 11.0 x 1	16.8 x 1 + 14.6 x 1 + 11.0 x 1
Number of maximum connectable indoor units		61(64)	64	64	64
Net Weight	kg	255 x 1 + 245 x 1	255 x 2	245 x 1 + 190 x 1 + 175 x 1	255 x 1 + 190 x 1 + 175 x 1
	lbs	562 x 1 + 540 x 1	562 x 2	540 x 1 + 419 x 1 + 386 x 1	562 x 1 + 419 x 1 + 386 x 1
Dimensions (WxHxD)	mm	(1,240 x 1,680 x 760) x 2	(1,240 x 1,680 x 760) x 2	(1,240 x 1,680 x 760) x 1 + (920 x 1,680 x 760) x 2	(1,240 x 1,680 x 760) x 1 + (920 x 1,680 x 760) x 2
	inch	(48-13/16 x 66-5/32 x 29-29/32) x 2	(48-13/16 x 66-5/32 x 29-29/32) x 2	(48-13/16 x 66-5/32 x 29-29/32) x 1 + (36-7/32 x 66-5/32 x 29-29/32) x 2	(48-13/16 x 66-5/32 x 29-29/32) x 1 + (36-7/32 x 66-5/32 x 29-29/32) x 2
Piping Connections	mm(inch)	Ø 19.05(3/4)	Ø 19.05(3/4)	Ø 19.05(3/4)	Ø 19.05(3/4)
	mm(inch)	Ø 41.3(1-5/8)	Ø 41.3(1-5/8)	Ø 41.3(1-5/8)	Ø 41.3(1-5/8)

Unit		3 Outdoor Units			
System(HP)		46	48	50	52
Model	Combination Unit	A/C/RUN460LLS4	A/C/RUN480LLS4	A/C/RUN500LLS4	A/C/RUN520LLS4
	Independent Unit	A/C/RUN200LLS4	A/C/RUN200LLS4	A/C/RUN200LLS4	A/C/RUN200LLS4
		A/C/RUN160LLS4	A/C/RUN180LLS4	A/C/RUN200LLS4	A/C/RUN200LLS4
		A/C/RUN100LLS4	A/C/RUN100LLS4	A/C/RUN100LLS4	A/C/RUN120LLS4
Refrigerant Precharged Amount	kg	7.6 x 1 + 6.0 x 1 + 5.0 x 1	7.6 x 1 + 6.0 x 1 + 5.0 x 1	7.6 x 2 + 5.0 x 1	7.6 x 2 + 5.0 x 1
	lbs	16.8 x 1 + 13.2 x 1 + 11.0 x 1	16.8 x 1 + 13.2 x 1 + 11.0 x 1	16.8 x 2 + 11.0 x 1	16.8 x 2 + 11.0 x 1
Number of maximum connectable indoor units		64	64	64	64
Net Weight	kg	255 x 1 + 205 x 1 + 175 x 1	255 x 1 + 245 x 1 + 175 x 1	255 x 2 + 175 x 1	255 x 2 + 180 x 1
	lbs	562 x 1 + 452 x 1 + 386 x 1	562 x 1 + 540 x 1 + 386 x 1	562 x 2 + 386 x 1	562 x 2 + 397 x 1
Dimensions (WxHxD)	mm	(1,240 x 1,680 x 760) x 2 + (920 x 1,680 x 760) x 1	(1,240 x 1,680 x 760) x 2 + (920 x 1,680 x 760) x 1	(1,240 x 1,680 x 760) x 2 + (920 x 1,680 x 760) x 1	(1,240 x 1,680 x 760) x 2 + (920 x 1,680 x 760) x 1
	inch	(48-13/16 x 66-5/32 x 29-29/32) x 2 + (36-7/32 x 66-5/32 x 29-29/32) x 1	(48-13/16 x 66-5/32 x 29-29/32) x 2 + (36-7/32 x 66-5/32 x 29-29/32) x 1	(48-13/16 x 66-5/32 x 29-29/32) x 2 + (36-7/32 x 66-5/32 x 29-29/32) x 1	(48-13/16 x 66-5/32 x 29-29/32) x 2 + (36-7/32 x 66-5/32 x 29-29/32) x 1
Piping Connections	mm(inch)	Ø 19.05(3/4)	Ø 19.05(3/4)	Ø 19.05(3/4)	Ø 19.05(3/4)
	mm(inch)	Ø 41.3(1-5/8)	Ø 41.3(1-5/8)	Ø 41.3(1-5/8)	Ø 41.3(1-5/8)

Unit		3 Outdoor Units			
System(HP)		54	56	58	60
Model	Combination Unit	A/C/RUN540LLS4	A/C/RUN560LLS4	A/C/RUN580LLS4	A/C/RUN600LLS4
	Independent Unit	A/C/RUN200LLS4	A/C/RUN200LLS4	A/C/RUN200LLS4	A/C/RUN200LLS4
		A/C/RUN200LLS4	A/C/RUN200LLS4	A/C/RUN200LLS4	A/C/RUN200LLS4
		A/C/RUN140LLS4	A/C/RUN160LLS4	A/C/RUN180LLS4	A/C/RUN200LLS4
Refrigerant Precharged Amount	kg	7.6 x 2 + 6.6 x 1	7.6 x 2 + 6.0 x 1	7.6 x 2 + 6.0 x 1	7.6 x 3
	lbs	16.8 x 2 + 14.6 x 1	16.8 x 2 + 13.2 x 1	16.8 x 2 + 13.2 x 1	16.8 x 3
Number of maximum connectable indoor units		64	64	64	64
Net Weight	kg	255 x 2 + 190 x 1	255 x 2 + 205 x 1	255 x 2 + 245 x 1	255 x 3
	lbs	562 x 2 + 419 x 1	562 x 2 + 452 x 1	562 x 2 + 540 x 1	562 x 3
Dimensions (WxHxD)	mm	(1,240 x 1,680 x 760) x 2 + (920 x 1,680 x 760) x 1	(1,240 x 1,680 x 760) x 3	(1,240 x 1,680 x 760) x 3	(1,240 x 1,680 x 760) x 3
	inch	(48-13/16 x 66-5/32 x 29-29/32) x 2 + (36-7/32 x 66-5/32 x 29-29/32) x 1	(48-13/16 x 66-5/32 x 29-29/32) x 3	(48-13/16 x 66-5/32 x 29-29/32) x 3	(48-13/16 x 66-5/32 x 29-29/32) x 3
Piping Connections	mm(inch)	Ø 19.05(3/4)	Ø 19.05(3/4)	Ø 19.05(3/4)	Ø 19.05(3/4)
	mm(inch)	Ø 41.3(1-5/8)	Ø 41.3(1-5/8)	Ø 41.3(1-5/8)	Ø 41.3(1-5/8)

Unit		4 Outdoor Units			
System(HP)		62	64	66	68
Model	Combination Unit	A(C)RUN620LLS4	A(C)RUN640LLS4	A(C)RUN660LLS4	A(C)RUN680LLS4
		A(C)RUN180LLS4	A(C)RUN180LLS4	A(C)RUN180LLS4	A(C)RUN200LLS4
	Independent Unit	A(C)RUN160LLS4	A(C)RUN180LLS4	A(C)RUN180LLS4	A(C)RUN200LLS4
		A(C)RUN140LLS4	A(C)RUN140LLS4	A(C)RUN160LLS4	A(C)RUN140LLS4
		A(C)RUN140LLS4	A(C)RUN140LLS4	A(C)RUN140LLS4	A(C)RUN140LLS4
Refrigerant Precharged Amount	kg	6.0 × 2 + 6.6 × 2	6.0 × 2 + 6.6 × 2	6.0 × 3 + 6.6 × 1	7.6 × 2 + 6.6 × 2
	lbs	13.2 × 2 + 14.6 × 2	13.2 × 2 + 14.6 × 2	13.2 × 3 + 14.6 × 1	16.8 × 2 + 14.6 × 2
Number of maximum connectable indoor units		64	64	64	64
Net Weight	kg	245 × 1 + 205 × 1 + 190 × 2	245 × 2 + 190 × 2	245 × 2 + 205 × 1 + 190 × 1	255 × 2 + 190 × 2
	lbs	540 × 1 + 452 × 1 + 396 × 2	540 × 2 + 396 × 2	540 × 2 + 452 × 1 + 396 × 1	562 × 2 + 396 × 2
Dimensions (WxHxD)	mm	(1,240 × 1,680 × 760) × 2 + (920 × 1,680 × 760) × 2	(1,240 × 1,680 × 760) × 2 + (920 × 1,680 × 760) × 2	(1,240 × 1,680 × 760) × 3 + (920 × 1,680 × 760) × 1	(1,240 × 1,680 × 760) × 2 + (920 × 1,680 × 760) × 2
	inch	(48-13/16 × 66-5/32 × 29-29/32) × 2 + (36-7/32 × 66-5/32 × 29-29/32) × 2	(48-13/16 × 66-5/32 × 29-29/32) × 2 + (36-7/32 × 66-5/32 × 29-29/32) × 2	(48-13/16 × 66-5/32 × 29-29/32) × 3 + (36-7/32 × 66-5/32 × 29-29/32) × 1	(48-13/16 × 66-5/32 × 29-29/32) × 2 + (36-7/32 × 66-5/32 × 29-29/32) × 2
Piping Connections	mm(inch)	Ø 22.2(7/8)	Ø 22.2(7/8)	Ø 22.2(7/8)	Ø 22.2(7/8)
	mm(inch)	Ø 44.5(1-3/4)	Ø 44.5(1-3/4)	Ø 53.98(2-1/8)	Ø 53.98(2-1/8)

Unit		4 Outdoor Units			
System(HP)		70	72	74	76
Model	Combination Unit	A(C)RUN700LLS4	A(C)RUN720LLS4	A(C)RUN740LLS4	A(C)RUN760LLS4
		A(C)RUN200LLS4	A(C)RUN200LLS4	A(C)RUN200LLS4	A(C)RUN200LLS4
	Independent Unit	A(C)RUN200LLS4	A(C)RUN200LLS4	A(C)RUN200LLS4	A(C)RUN200LLS4
		A(C)RUN160LLS4	A(C)RUN180LLS4	A(C)RUN180LLS4	A(C)RUN180LLS4
		A(C)RUN140LLS4	A(C)RUN140LLS4	A(C)RUN160LLS4	A(C)RUN180LLS4
Refrigerant Precharged Amount	kg	7.6 × 2 + 6.0 × 1 + 6.6 × 1	7.6 × 2 + 6.0 × 1 + 6.6 × 1	7.6 × 2 + 6.0 × 2	7.6 × 2 + 6.0 × 2
	lbs	16.8 × 2 + 13.2 × 1 + 14.6 × 2	16.8 × 2 + 13.2 × 1 + 14.6 × 2	16.8 × 2 + 13.2 × 2	16.8 × 2 + 13.2 × 2
Number of maximum connectable indoor units		64	64	64	64
Net Weight	kg	255 × 2 + 205 × 1 + 190 × 1	255 × 2 + 245 × 1 + 190 × 1	255 × 2 + 245 × 1 + 205 × 1	255 × 2 + 245 × 2
	lbs	562 × 2 + 452 × 1 + 396 × 1	562 × 2 + 540 × 1 + 396 × 1	562 × 2 + 540 × 1 + 452 × 1	562 × 2 + 540 × 2
Dimensions (WxHxD)	mm	(1,240 × 1,680 × 760) × 3 + (920 × 1,680 × 760) × 1	(1,240 × 1,680 × 760) × 3 + (920 × 1,680 × 760) × 1	(1,240 × 1,680 × 760) × 4	(1,240 × 1,680 × 760) × 4
	inch	(48-13/16 × 66-5/32 × 29-29/32) × 3 + (36-7/32 × 66-5/32 × 29-29/32) × 1	(48-13/16 × 66-5/32 × 29-29/32) × 3 + (36-7/32 × 66-5/32 × 29-29/32) × 1	(48-13/16 × 66-5/32 × 29-29/32) × 4	(48-13/16 × 66-5/32 × 29-29/32) × 4
Piping Connections	mm(inch)	Ø 22.2(7/8)	Ø 22.2(7/8)	Ø 22.2(7/8)	Ø 22.2(7/8)
	mm(inch)	Ø 53.98(2-1/8)	Ø 53.98(2-1/8)	Ø 53.98(2-1/8)	Ø 53.98(2-1/8)

Unit		4 Outdoor Units	
System(HP)		78	80
Model	Combination Unit	A(C)RUN780LLS4	A(C)RUN800LLS4
		A(C)RUN200LLS4	A(C)RUN200LLS4
	Independent Unit	A(C)RUN200LLS4	A(C)RUN200LLS4
		A(C)RUN200LLS4	A(C)RUN200LLS4
		A(C)RUN180LLS4	A(C)RUN200LLS4
Refrigerant Precharged Amount	kg	7.6 × 3 + 6.0 × 1	7.6 × 4
	lbs	16.8 × 3 + 13.2 × 1	16.8 × 4
Number of maximum connectable indoor units		64	64
Net Weight	kg	255 × 3 + 245 × 1	255 × 4
	lbs	562 × 3 + 540 × 1	562 × 4
Dimensions (WxHxD)	mm	(1,240 × 1,680 × 760) × 4	(1,240 × 1,680 × 760) × 4
	inch	(48-13/16 × 66-5/32 × 29-29/32) × 4	(48-13/16 × 66-5/32 × 29-29/32) × 4
Piping Connections	mm(inch)	Ø 22.2(7/8)	Ø 22.2(7/8)
	mm(inch)	Ø 53.98(2-1/8)	Ø 53.98(2-1/8)

■ Space Saving Model

Unit		2 Outdoor Units		
System(HP)		22	42	44
Model	Combination Unit	A(C)RUN220LLN4	A(C)RUN420LLN4	A(C)RUN440LLN4
	Independent Unit	A(C)RUN220LLN4	A(C)RUN220LLN4	A(C)RUN220LLN4
			A(C)RUN200LLN4	A(C)RUN220LLN4
Refrigerant Precharged Amount	kg	7.6	7.6 × 2	7.6 × 2
	lbs	16.8	16.8 × 2	16.8 × 2
Number of maximum connectable indoor units		35(44)	64	64
Net Weight	kg	255 × 1	255 × 2	255 × 2
	lbs	562 × 1	562 × 2	562 × 2
Dimensions (WxHxD)	mm	(1,240 × 1,680 × 760) × 1	(1,240 × 1,680 × 760) × 2	(1,240 × 1,680 × 760) × 2
	inch	(48-13/16 × 66-5/32 × 29-29/32) × 1	(48-13/16 × 66-5/32 × 29-29/32) × 2	(48-13/16 × 66-5/32 × 29-29/32) × 2
Piping Connections	mm(inch)	Ø 15.88(5/8)	Ø 19.05(3/4)	Ø 19.05(3/4)
	mm(inch)	Ø 28.58(1-1/8)	Ø 41.3(1-5/8)	Ø 41.3(1-5/8)

Unit		3 Outdoor Units		
System(HP)		62	64	66
Model	Combination Unit	A(C)RUN620LLN4	A(C)RUN640LLN4	A(C)RUN660LLN4
		A(C)RUN220LLN4	A(C)RUN220LLN4	A(C)RUN220LLN4
	Independent Unit	A(C)RUN200LLN4	A(C)RUN200LLN4	A(C)RUN220LLN4
		A(C)RUN200LLN4	A(C)RUN200LLN4	A(C)RUN200LLN4
Refrigerant Precharged Amount	kg	7.6 × 3	7.6 × 3	7.6 × 3
	lbs	16.8 × 3	16.8 × 3	16.8 × 3
Number of maximum connectable indoor units		64	64	64
Net Weight	kg	255 × 3	255 × 3	255 × 3
	lbs	562 × 3	562 × 3	562 × 3
Dimensions (WxHxD)	mm	(1,240 × 1,680 × 760) × 3	(1,240 × 1,680 × 760) × 3	(1,240 × 1,680 × 760) × 3
	inch	48-13/16 × 66-5/32 × 29-29/32) × 3	48-13/16 × 66-5/32 × 29-29/32) × 3	48-13/16 × 66-5/32 × 29-29/32) × 3
Piping Connections	mm(inch)	Ø 22.2(7/8)	Ø 22.2(7/8)	Ø 22.2(7/8)
	mm(inch)	Ø 44.5(1-3/4)	Ø 44.5(1-3/4)	Ø 53.98(2-1/8)

Unit		4 Outdoor Units			
System(HP)		82	84	86	88
Model	Combination Unit	A(C)RUN820LLN4	A(C)RUN840LLN4	A(C)RUN860LLN4	A(C)RUN880LLN4
		A(C)RUN220LLN4	A(C)RUN220LLN4	A(C)RUN220LLN4	A(C)RUN220LLN4
	Independent Unit	A(C)RUN200LLN4	A(C)RUN220LLN4	A(C)RUN220LLN4	A(C)RUN220LLN4
		A(C)RUN200LLN4	A(C)RUN200LLN4	A(C)RUN220LLN4	A(C)RUN220LLN4
		A(C)RUN200LLN4	A(C)RUN200LLN4	A(C)RUN200LLN4	A(C)RUN220LLN4
Refrigerant Precharged Amount	kg	7.6 × 4	7.6 × 4	7.6 × 4	7.6 × 4
	lbs	16.8 × 4	16.8 × 4	16.8 × 4	16.8 × 4
Number of maximum connectable indoor units		64	64	64	64
Net Weight	kg	255 × 4	255 × 4	255 × 4	255 × 4
	lbs	562 × 4	562 × 4	562 × 4	562 × 4
Dimensions (WxHxD)	mm	(1,240 × 1,680 × 760) × 4	(1,240 × 1,680 × 760) × 4	(1,240 × 1,680 × 760) × 4	(1,240 × 1,680 × 760) × 4
	inch	(48-13/16 × 66-5/32 × 29-29/32) × 4	(48-13/16 × 66-5/32 × 29-29/32) × 4	(48-13/16 × 66-5/32 × 29-29/32) × 4	(48-13/16 × 66-5/32 × 29-29/32) × 4
Piping Connections	mm(inch)	Ø 22.2(7/8)	Ø 22.2(7/8)	Ø 22.2(7/8)	Ø 22.2(7/8)
	mm(inch)	Ø 53.98(2-1/8)	Ø 53.98(2-1/8)	Ø 53.98(2-1/8)	Ø 53.98(2-1/8)

ENVIRONMENT-FRIENDLY ALTERNATIVE REFRIGERANT R410A

The refrigerant R410A has the property of higher operating pressure in comparison with R22. Therefore, all materials have the characteristics of higher resisting pressure than R22 ones and this characteristic should be also considered during the installation.

R410A is an azeotrope of R32 and R125 mixed at 50:50, so the ozone depletion potential (ODP) of R410A is 0. These days the developed countries have approved it as the environment-friendly refrigerant and encouraged to use it widely to prevent environment pollution.

CAUTION

- The wall thickness of the piping should comply with the relevant local and national regulations for the designed pressure 3.8 MPa
- Since R410A is a mixed refrigerant, the required additional refrigerant must be charged in its liquid state.
If the refrigerant is charged in its gaseous state, its composition changes and the system will not work properly.
- Do not place the refrigerant container under the direct rays of the sun to prevent it from exploding.
- For high-pressure refrigerant, any unapproved pipe must not be used.
- Do not heat pipes more than necessary to prevent them from softening.
- Be careful not to install wrongly to minimize economic loss because it is expensive in comparison with R22.

SELECT THE BEST LOCATION

Select space for installing outdoor unit, which will meet the following conditions:

- No direct thermal radiation from other heat sources
- No possibility of annoying neighbors by noise from unit
- No exposition to strong wind
- With strength which bears weight of unit
- Note that drain flows out of unit when heating
- With space for air passage and service work shown next
- Because of the possibility of fire, do not install unit to the space where generation, inflow, stagnation, and leakage of combustible gas is expected.
- Avoid unit installation in a place where acidic solution and spray (sulfur) are often used.
- Do not use unit under any special environment where oil, steam and sulfuric gas exist.
- It is recommended to fence round the outdoor unit in order to prevent any person or animal from accessing the outdoor unit.
- If installation site is area of heavy snowfall, then the following directions should be observed.
 - Make the foundation as high as possible.
 - Fit a snow protection hood.
- Select installation location considering following conditions to avoid bad condition when additionally performing defrost operation.
 - Install the outdoor unit at a place well ventilated and having a lot of sunshine in case of installing the product at a place With a high humidity in winter (near beach, coast, lake, etc.) (Ex : Rooftop where there is always sunshine.)

INSTALLATION SPACE

Individual Installation

During the installation of the unit, consider service, inlet, and outlet and acquire the minimum space as shown in the figures below.

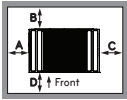
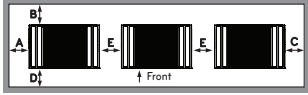
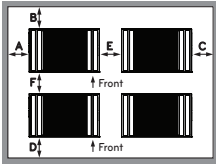
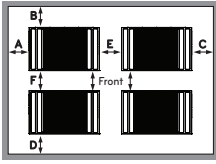
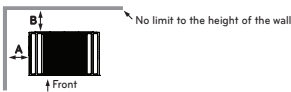
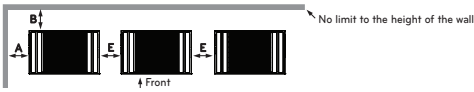
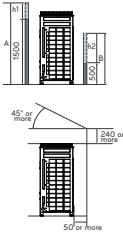
Category	Installation Space	Case 1 (10 mm ≤ Side Space ≤ 49 mm)	Case 2 (Side Space ≥ 49 mm)
4 sides are walls		A ≥ 10 B ≥ 300 C ≥ 10 D ≥ 500	A ≥ 50 B ≥ 100 C ≥ 50 D ≥ 500
		A ≥ 10 B ≥ 300 C ≥ 10 D ≥ 500 E ≥ 20	A ≥ 50 B ≥ 100 C ≥ 50 D ≥ 500 E ≥ 100
		A ≥ 10 B ≥ 300 C ≥ 10 D ≥ 500 E ≥ 20 F ≥ 600	A ≥ 50 B ≥ 100 C ≥ 50 D ≥ 500 E ≥ 100 F ≥ 500
		A ≥ 10 B ≥ 300 C ≥ 10 D ≥ 300 E ≥ 20 F ≥ 500	A ≥ 50 B ≥ 100 C ≥ 50 D ≥ 100 E ≥ 100 F ≥ 500
Only 2 sides are walls		A ≥ 10 B ≥ 300	
		A ≥ 200 B ≥ 300 E ≥ 400	
Limitations on the height of the wall (Refer to 4 side walls)	 <ul style="list-style-type: none"> • The height of the wall on the front side must be 1500mm or less. • The height of the wall on the inlet side must be 500mm or less. • There is no limit to the wall on the side. • If the height of the walls on the front and the side are higher than the limit, there must be additional space on the front and the side. <ul style="list-style-type: none"> - Additional Space on the front side by 1/2 of h1. - Additional Space on the inlet side by 1/2 of h2 - h1 = A(Actual height) - 1500 - h2 = B(Actual height) - 500 		

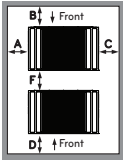
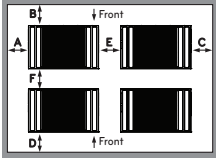
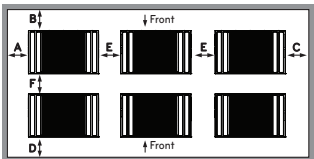
Category	Installation Space	Case 1 (10 mm ≤ Side Space ≤ 49 mm)	Case 2 (Side Space ≥ 49 mm)
Rear to Rear		<p>A ≥ 10 B ≥ 500 C ≥ 10 D ≥ 500 E ≥ 20 F ≥ 900</p>	<p>A ≥ 50 B ≥ 500 C ≥ 50 D ≥ 500 E ≥ 100 F ≥ 600</p>
		<p>A ≥ 10 B ≥ 500 C ≥ 10 D ≥ 500 E ≥ 20 F ≥ 1200</p>	<p>A ≥ 50 B ≥ 500 C ≥ 50 D ≥ 500 E ≥ 100 F ≥ 900</p>
		<p>A ≥ 10 B ≥ 500 C ≥ 10 D ≥ 500 E ≥ 20 F ≥ 1800</p>	<p>A ≥ 50 B ≥ 500 C ≥ 50 D ≥ 500 E ≥ 100 F ≥ 1200</p>

Seasonal wind and cautions in winter

- Sufficient measures are required in a snow area or severe cold area in winter so that product can be operated well.
- Get ready for seasonal wind or snow in winter even in other areas.
- Install a suction and discharge duct not to let in snow or rain.
- Install the outdoor unit not to come in contact with snow directly. If snow piles up and freezes on the air suction hole, the system may malfunction. If it is installed at snowy area, attach the hood to the system.
- Install the outdoor unit at the higher installation console by 50 cm than the average snowfall (annual average snowfall) if it is installed at the area with much snowfall.
- Where snow accumulated on the upper part of the Outdoor Unit by more than 10 cm, always remove snow for operation.

- The height of H frame must be more than 2 times the snowfall and its width shall not exceed the width of the product. (If width of the frame is wider than that of the product, snow may accumulate)

- Don't install the suction hole and discharge hole of the Outdoor Unit facing the seasonal wind.

LIFTING METHOD

- When carrying the suspended, unit pass the ropes under the unit and use the two suspension points each at the front and rear.
- Always lift the unit with ropes attached at four points so that impact is not applied to the unit.
- Attach the ropes to the unit at an angle of 40° or less.

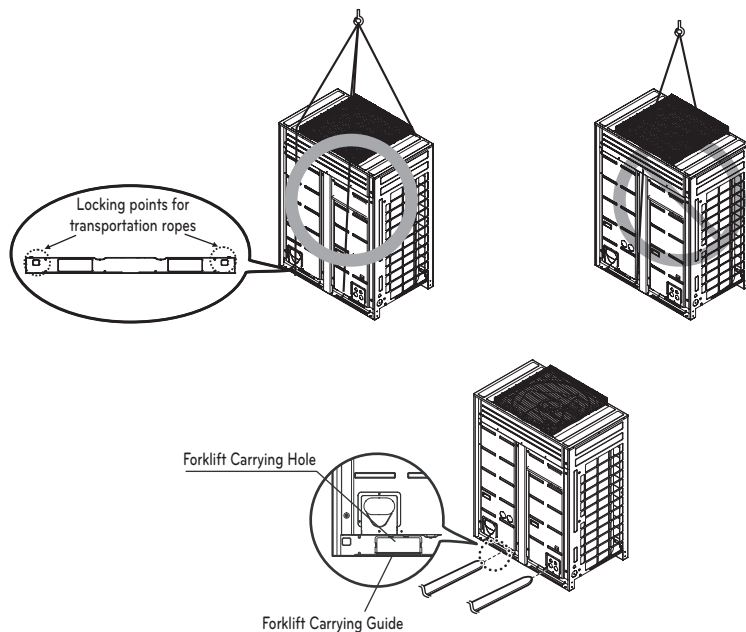

! CAUTION

Be very careful while carrying the product.

- Do not have only one person carry product if it is more than 20 kg.
- PP bands are used to pack some products. Do not use them as a mean for transportation because they are dangerous.
- Do not touch heat exchanger fins with your bare hands. Otherwise you may get a cut in your hands.
- Tear plastic packaging bag and scrap it so that children cannot play with it. Otherwise plastic packaging bag may suffocate children to death.
- When carrying in Outdoor Unit, be sure to support it at four points. Carrying in and lifting with 3-point support may make Outdoor Unit unstable, resulting in a fall.
- Use 2 belts of at least 8 m long.
- Place extra cloth or boards in the locations where the casing comes in contact with the sling to prevent damage.
- Hoist the unit making sure it is being lifted at its center of gravity.

INSTALLATION

- Install at places where it can endure the weight and vibration/noise of the outdoor unit.
- The outdoor unit supports at the bottom shall have width of at least 100 mm under the Unit's legs before being fixed.
- The outdoor unit supports should have minimum height of 200 mm.
- Anchor bolts must be inserted at least 75 mm.

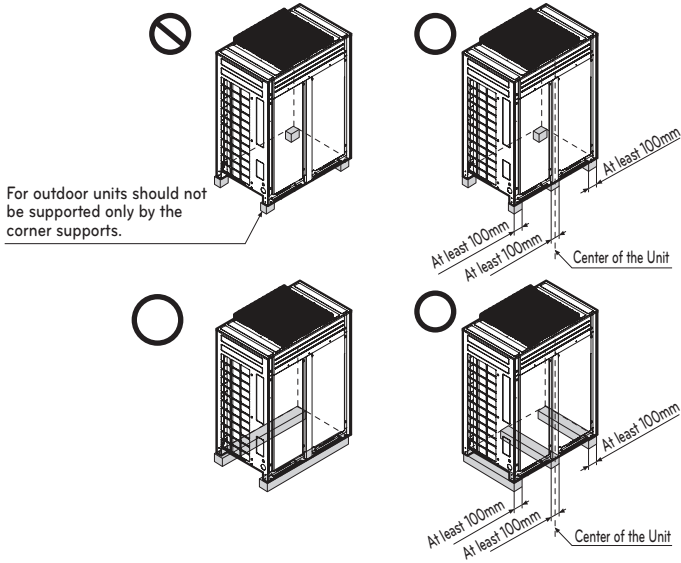

The location of the Anchor bolts

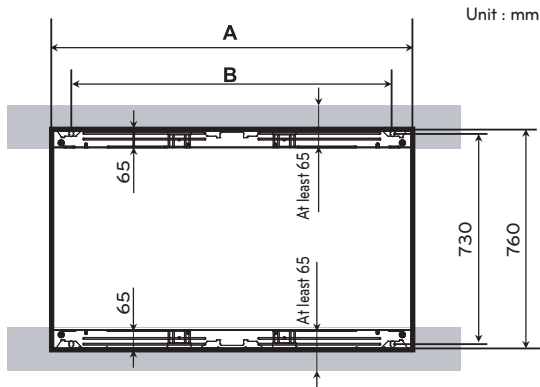

Chassis	Outdoor Unit Capacity	A(mm)	B(mm)
UX5	8~14 HP	920	792
UX6	16~22 HP	1240	1102

Foundation for Installation

- Fix the unit tightly with bolts as shown below so that unit will not fall down due to earthquake or gust.
- Use the H-beam support as a base support
- Noise and vibration may occur from the floor or wall since vibration is transferred through the installation part depending on installation status. Thus, use anti-vibration materials (cushion pad) fully (The base pad shall be more than 200 mm).

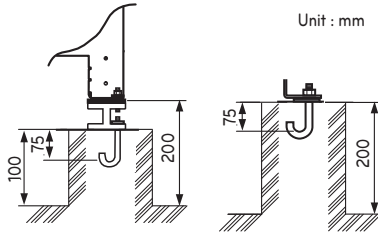
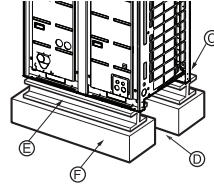
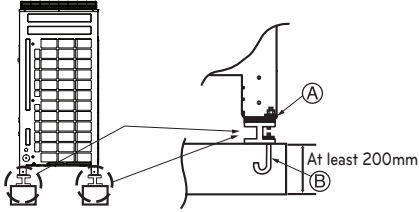

- Ⓐ The corner part must be fixed firmly. Otherwise, the support for the installation may be bent.
- Ⓑ Get and use M10 Anchor bolt.
- Ⓒ Put Cushion Pad between the outdoor unit and ground support for the vibration protection in wide area.
- Ⓓ Space for pipes and wiring (Pipes and wirings for bottom side)
- Ⓔ H-beam support
- Ⓕ Concrete support

⚠ WARNING

- Install where it can sufficiently support the weight of the outdoor unit.
If the support strength is not enough, the outdoor unit may drop and hurt people.
- Install where the outdoor unit may not fall in strong wind or earthquake.
If there is a fault in the supporting conditions, the outdoor unit may fall and hurt people.
- Please take extra cautions on the supporting strength of the ground, water outlet treatment (treatment of the water flowing out of the outdoor unit in operation), and the passages of the pipe and wiring, when making the ground support.
- Do not use tube or pipe for water outlet in the Base pan. Use drainage instead for water outlet. The tube or pipe may freeze and the water may not be drained.

⚠ CAUTION

- Be sure to remove the Pallet (Wood Support) of the bottom side of the outdoor unit Base Pan before fixing the bolt. It may cause the unstable state of the outdoor settlement, and may cause freezing of the heat exchanger resulting in abnormal operations.
- Be sure to remove the Pallet (Wood Support) of the bottom side of the outdoor unit before welding. Not removing Pallet (Wood Support) causes hazard of fire during welding.

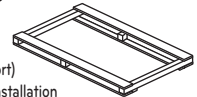
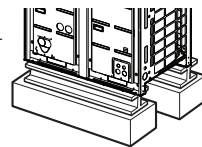

Pallet (Wood Support)
- Remove before Installation

Preparation of Piping

Main cause of gas leakage is defect in flaring work. Carry out correct flaring work in the following procedure.

Cut the pipes and the cable

- Use the accessory piping kit or the pipes purchased locally.
- Measure the distance between the indoor and the outdoor unit.
- Cut the pipes a little longer than measured distance.
- Cut the cable 1.5 m longer than the pipe length.

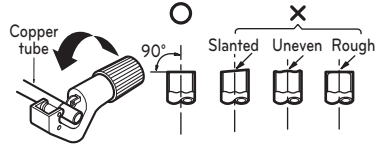

Burrs removal

- Completely remove all burrs from the cut cross section of pipe/tube.
- Put the end of the copper tube/pipe to downward direction as you remove burrs in order to avoid to let burrs drop in the tubing.

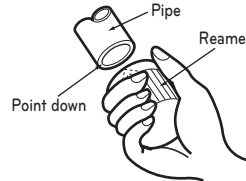

Flaring work

- Carry out flaring work using flaring tool as shown below.

Indoor unit [kW(Btu/h)]	Pipe		" A "	
	Gas	Liquid	Gas	Liquid
< 5.6(19,100)	1/2"	1/4"	0.5~0.8	0~0.5
< 16.0(54,600)	5/8"	3/8"	0.8~1.0	0.5~0.8
< 22.4(76,400)	3/4"	3/8"	1.0~1.3	0.5~0.8

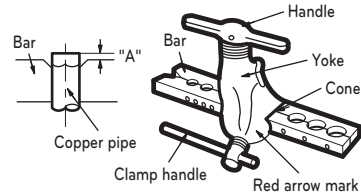

Firmly hold copper tube in a bar(or die) as indicated dimension in the table above.

Check

- Compare the flared work with figure below.
- If flare is noted to be defective, cut off the flared section and do flaring work again.

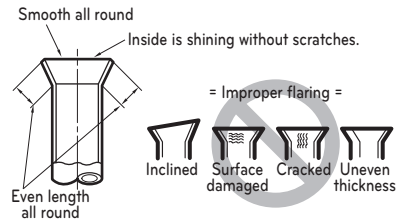

Flare shape and flare nut tightening torque

Precautions when connecting pipes

- See the following table for flare part machining dimensions.
- When connecting the flare nuts, apply refrigerant oil to the inside and outside of the flares and turn them three or four times at first. (Use ester oil or ether oil.)
- See the following table for tightening torque. (Applying too much torque may cause the flares to crack.)
- After all the piping has been connected, use nitrogen to perform a gas leak check.

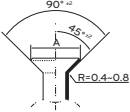
Pipe size	Tightening torque(N·cm)	A(mm)	Flare shape
Ø 9.52	38 ± 4	12.8 - 13.2	
Ø 12.7	55 ± 6	16.2 - 16.6	
Ø 15.88	75 ± 7	19.3 - 19.7	

CAUTION

- Always use a charge hose for service port connection.
- After tightening the cap, check that no refrigerant leaks are present.
- When loosening a flare nut, always use two wrenches in combination. When connecting the piping, always use a spanner and torque wrench in combination to tighten the flare nut.
- When connecting a flare nut, coat the flare (inner and outer faces) with oil for R410A(PVE) and hand tighten the nut 3 to 4 turns as the initial tightening.

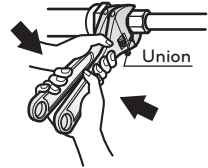

Opening shutoff valve

- 1 Remove the cap and turn the valve counter clockwise with the hexagon wrench.
- 2 Turn it until the shaft stops.
Do not apply excessive force to the shutoff valve. Doing so may break the valve body, as the valve is not a backseat type. Always use the special tool.
- 3 Make sure to tighten the cap securely.

Closing shutoff valve

- 1 Remove the cap and turn the valve clockwise with the hexagon wrench.
- 2 Securely tighten the valve until the shaft contacts the main body seal.
- 3 Make sure to tighten the cap securely.
 * For the tightening torque, refer to the table on the below.

Tightening torque

Shutoff valve size	Tightening torque N·m(Turn clockwise to close)					
	Shaft(valve body)		Cap(Valve lid)	Service port	Flare nut	Gas line piping attached to unit
Ø 6.35	6 ± 0.6	Hexagonal wrench 4 mm	29.4 ± 2.9	12.7±2	16 ± 2	-
Ø 9.52					38 ± 4	
Ø 12.7					55 ± 6	
Ø 15.88	15 ± 1.5	Hexagonal wrench 6 mm	53.9 ± 5.8	12.7±2	75 ± 7	25 ± 3
Ø 22.2	30 ± 3	Hexagonal wrench 10 mm				
Ø 25.4						

Insulation of shutoff valve

- 1 Use the heat insulation material for the refrigerant piping which has an excellent heat-resistance (over 120 °C).
- 2 Precautions in high humidity circumstance:
 This air conditioner has been tested according to the "ISO Conditions with Mist" and confirmed that there is not any default. However, if it is operated for a long time in high humid atmosphere (dew point temperature: more than 23 °C), water drops are liable to fall. In this case, add heat insulation material according to the following procedure:
 - Heat insulation material to be prepared... EPDM (Ethylene Propylene Diene Methylene)-over 120 °C the heat-resistance temperature.
 - Add the insulation over 10 mm thickness at high humidity environment.

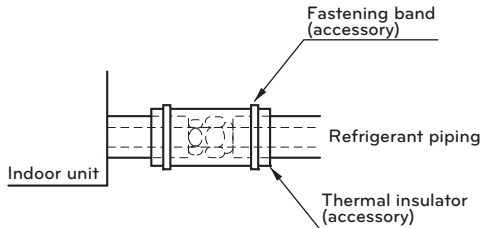

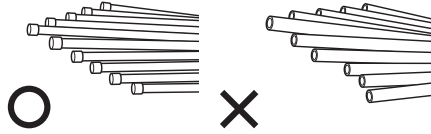

Plumbing materials and storage methods

Pipe must be able to obtain the specified thickness and should be used with low impurities. Also when handling storage, pipe must be careful to prevent a fracture, deformity and wound. Should not be mixed with contaminations such as dust, moisture.



Refrigerant piping on three principles

	Drying	Cleanliness	Airtight
	Should be no moisture inside	No dust inside.	There is no refrigerant leakage
Items			
Cause failure	<ul style="list-style-type: none"> - Significant hydrolysis of refrigerant oil - Degradation of refrigerant oil - Poor insulation of the compressor - Do not cold and warm - Clogging of EEV, Capillary 	<ul style="list-style-type: none"> - Degradation of refrigerant oil - Poor insulation of the compressor - Do not cold and warm - Clogging of EEV, Capillary 	<ul style="list-style-type: none"> - Gas shortages - Degradation of refrigerant oil - Poor insulation of the compressor - Do not cold and warm
Countermeasure	<ul style="list-style-type: none"> - No moisture in the pipe - Until the connection is completed, the plumbing pipe entrance should be strictly controlled. - Stop plumbing at rainy day. - Pipe entrance should be taken side or bottom. - When removal burr after cutting pipe, pipe entrance should be taken down. - Pipe entrance should be fitted cap when pass through the walls. 	<ul style="list-style-type: none"> - No dust in the pipe. - Until the connection is completed, the plumbing pipe entrance should be strictly controlled. - Pipe entrance should be taken side or bottom. - When removal burr after cutting pipe, pipe entrance should be taken down. - Pipe entrance should be fitted cap when pass through the walls. 	<ul style="list-style-type: none"> - Airtightness test should be. - Brazing operations to comply with standards. - Flare to comply with standards. - Flange connections to comply with standards.

Nitrogen substitution method

Welding, as when heating without nitrogen substitution a large amount of the oxide film is formed on the internal piping.

The oxide film is caused by clogging EEV, Capillary, oil hole of accumulator and suction hole of oil pump in compressor.

It prevents normal operation of the compressor.

In order to avoid this problem, Welding should be done after replacing air by nitrogen gas.

When welding plumbing pipe, the work is required.

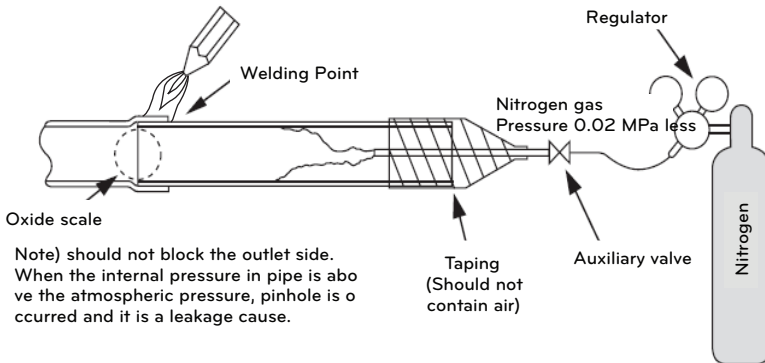

CAUTION

- 1 Always use the nitrogen.(not use oxygen, carbon dioxide, and a Chevron gas):
Please use the following nitrogen pressure 0.02 MPa
Oxygen – Promotes oxidative degradation of refrigerant oil.
Because it is flammable, it is strictly prohibited to use
Carbon dioxide – Degrade the drying characteristics of gas
Chevron Gas – Toxic gas occurs when exposed to direct flame.
- 2 Always use a pressure reducing valve.
3. Please do not use commercially available antioxidant.
The residual material seems to be the oxide scale is observed.
In fact, due to the organic acids generated by oxidation of the alcohol contained in the antioxidants, ants nest corrosion occurs. (causes of organic acid → alcohol + copper + water + temperature)

REFRIGERANT PIPING INSTALLATION

Precautions on Pipe connection / Valve operation

Pipe connection is done by connecting from the end of the pipe to the branching pipes, and the refrigerant pipe coming out of the outdoor unit is divided at the end to connect to each indoor unit. Flare connection for the indoor unit, and welding connection for the outdoor pipe and the branching parts.

- Use hexagonal wrench to open/close the valve.

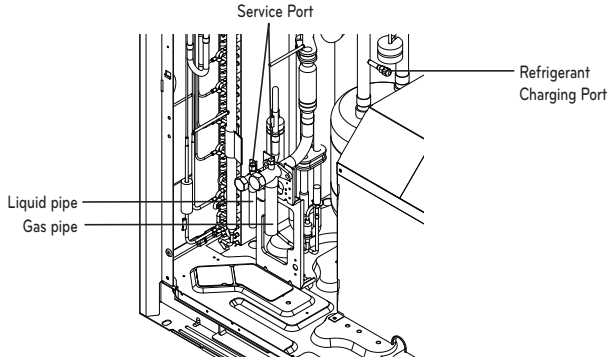

⚠ WARNING

- Always careful not to leak the refrigerant during welding.
- The refrigerant generates poisonous gas harmful to human body if combusted.
- Do not perform welding in a closed space.
- Be sure to close the cap of the service port to prevent gas leakage after the work.

⚠ CAUTION

Please block the pipe knock outs of the front and side panels after installing the pipes.
(Animals or foreign objects may be brought in to damage wires.)

PIPE CONNECTIONS BETWEEN INDOOR AND OUTDOOR UNIT

- Install at places where it can endure the weight and vibration/noise of the outdoor unit.
- The outdoor unit supports at the bottom shall have width of at least 100 mm under the unit's legs before being fixed.
- The outdoor unit supports should have minimum height of 200 mm.
- Anchor bolts must be inserted at least 75 mm.

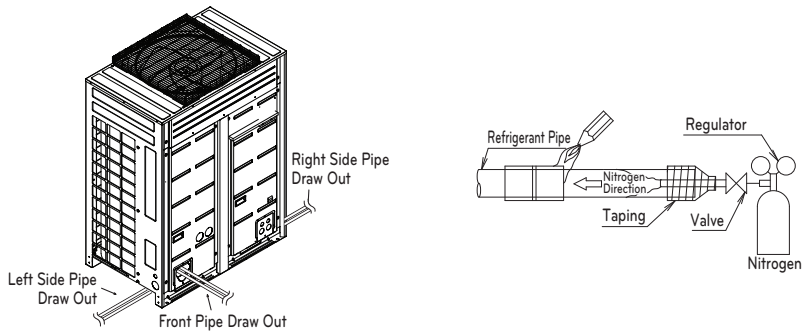

Preparation Work

- Use Knock Outs of Base Pan of the outdoor unit for Left/Right or Bottom pipe drawing outs.

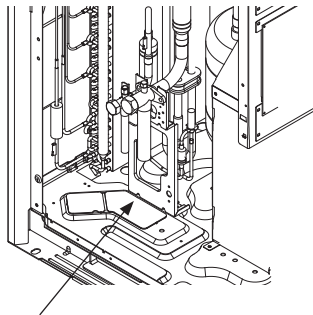

Removal Area for Liquid/Gas pipe bottom side connections.

CAUTION

- Do not give damage to the pipe/base during the Knock Out work.
- Proceed to pipe work after removing burr after Knock Out work.
- Perform sleeve work to prevent damage to the wire when connecting wires using knock Outs.

Remove leakage prevention cap

- Remove the leakage prevention cap attached to the outdoor unit service valve before pipe work.
- Proceed the leakage prevention cap removal as follows:
 - Verify whether the liquid/gas pipes are locked.
 - Extract remaining refrigerant or air inside using the service port.
 - Remove the leakage prevention cap

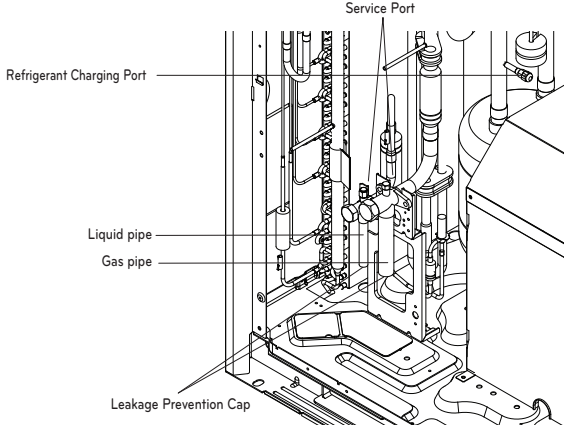

Pipe Drawing Out during Single / Series connection

Method of drawing out pipes on the front side

- Proceed with the pipe work as shown in the below figure for front side pipe drawing out.

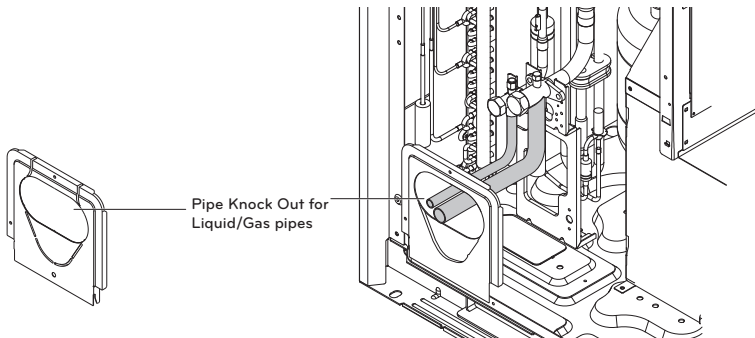

Method of drawing out pipes on the bottom side

- Drawing out common pipe through side panel

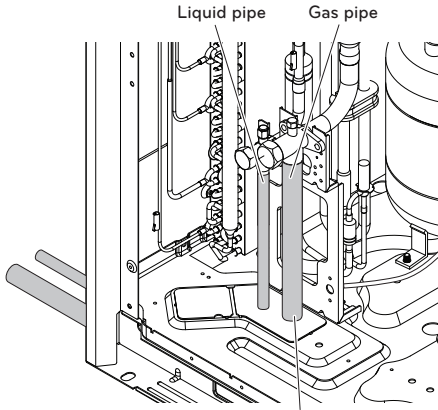

Remove only liquid/gas pipe Knock out

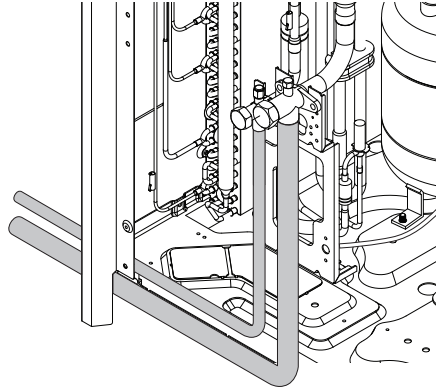

Refrigerant piping system

1 Outdoor Unit

Y branch method

- (A) : Outdoor Unit
- (B) : 1st branch (Y branch)
- (C) : Indoor Units

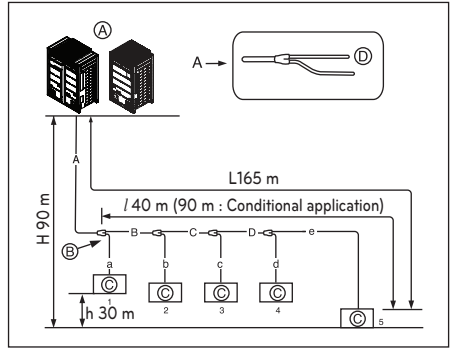

Combination of Y branch/header Method

- (A) : Outdoor Unit
- (B) : 1st branch (Y branch)
- (C) : Y branch
- (D) : Indoor Unit
- (E) : Header
- (F) : Sealed piping

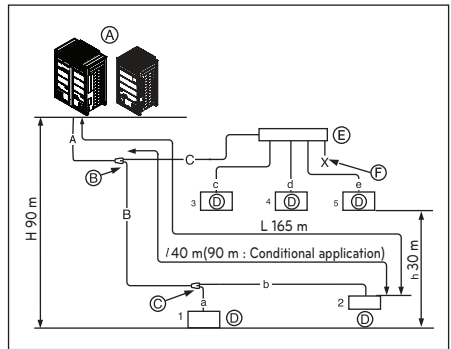

Header Method

- (A) : Outdoor Unit
- (B) : Header branch
- (C) : Indoor Units
- (D) : Sealed piping

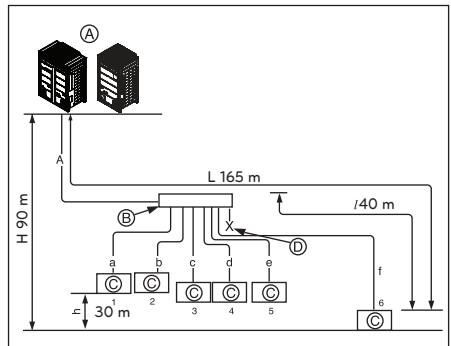

Series Outdoor Units (2 Units ~ 4 Units)

Y branch method

- Ⓐ : Outdoor Unit
- Ⓑ : 1st branch (Y branch)
- Ⓒ : Indoor Units
- Ⓓ : Downward Indoor Unit
- Ⓔ : Connection branch pipe between Outdoor units: ARCNN31
- Ⓕ : Connection branch pipe between Outdoor units: ARCNN21

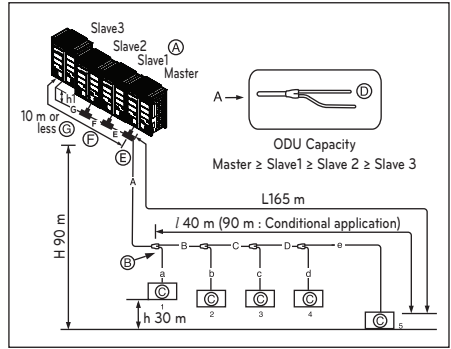

Combination of Y branch/header Method

- Ⓐ : Outdoor Unit
- Ⓑ : 1st branch (Y branch)
- Ⓒ : Y branch
- Ⓓ : Indoor Unit
- Ⓔ : Connection branch pipe between Outdoor units : ARCNN41
- Ⓕ : Connection branch pipe between Outdoor units : ARCNN31
- Ⓖ : Connection branch pipe between Outdoor units : ARCNN21
- Ⓗ : Header
- Ⓙ : Sealing

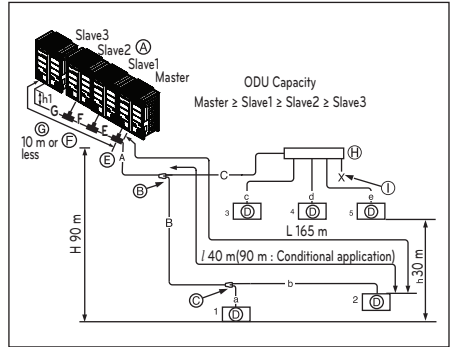

Header Method

- Ⓐ : Outdoor Unit
- Ⓑ : Header branch
- Ⓒ : Indoor Units
- Ⓓ : Sealing
- Ⓔ : Connection branch pipe between Outdoor units : ARCNN41
- Ⓕ : Connection branch pipe between Outdoor units : ARCNN31
- Ⓖ : Connection branch pipe between Outdoor units : ARCNN21

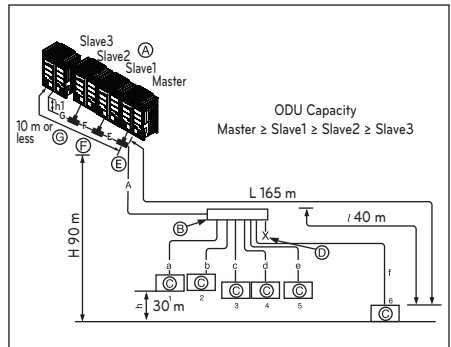

Pipe Connection Method between outdoor unit/indoor unit

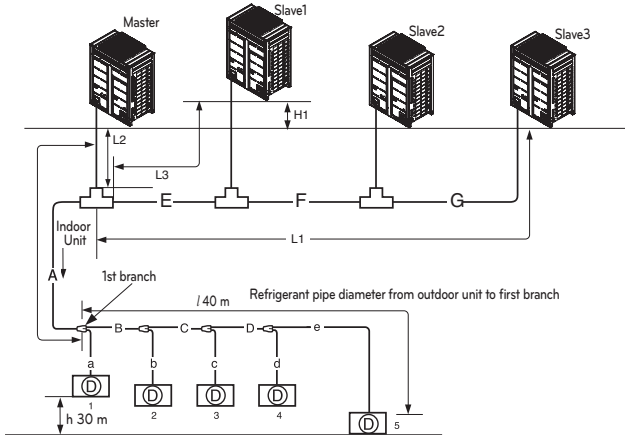

* See Table 2

A : Refrigerant pipe diameter from outdoor unit to first branch

E : Refrigerant pipe diameter for outdoor unit capacity (Slave 1 + Slave 2 + Slave 3)

F : Refrigerant pipe diameter for outdoor unit capacity (Slave 2 + Slave 3)

G : Refrigerant pipe diameter for outdoor unit capacity(Slave 3)

Level Difference (Outdoor unit ↔ Outdoor unit)	5 m
Max length from first branch to each outdoor unit (L1, L2, L3)	Less than 10 m (equivalent length of piping 13 m)

(Table 1) Limit Pipe length

			Y branch Method	Combination of Y branch/header Method	Header Method
Max pipe length	Outdoor Unit ↔ Indoor Unit	Longest pipe length(L)	$A+B+C+D+e \leq 165 \text{ m}$	$A+B+b \leq 165 \text{ m}$ $A+C+e \leq 165 \text{ m}$	$A+f \leq 165 \text{ m}$
		Equivalent pipe length	190 m	190 m	190 m
		Total pipe length	1,000 m	1,000 m	1,000 m
Max difference in height	Outdoor Unit ↔ Indoor Unit	Difference in height(H)	90 m	90 m	90 m
	Indoor Unit ↔ Indoor Unit	Difference in height(h)	30 m	30 m	30 m
Longest pipe length after 1st branch		Pipe length(l)	40 m (90 m: Conditional application)*	40 m (90 m: Conditional application)*	40 m

* * : See Table 4

Refrigerant pipe diameter from branch to branch (B,C,D)

Downward Indoor Unit total capacity [kW(Btu/h)]	Liquid pipe [mm(inch)]	Gas pipe [mm(inch)]
≤ 5.6(19,100)	Ø 6.35(1/4)	Ø 12.7(1/2)
< 16.0(54,600)	Ø 9.52(3/8)	Ø 15.88(5/8)
≤ 22.4(76,400)	Ø 9.52(3/8)	Ø 19.05(3/4)
< 33.6(114,700)	Ø 9.52(3/8)	Ø 22.2(7/8)
< 50.4(172,000)	Ø 12.7(1/2)	Ø 28.58(1-1/8)
< 67.2(229,400)	Ø 15.88(5/8)	Ø 28.58(1-1/8)
< 72.8(248,500)	Ø 15.88(5/8)	Ø 34.9(1-3/8)
< 100.8(344,000)	Ø 19.05(3/4)	Ø 34.9(1-3/8)
< 173.6(592,500)	Ø 19.05(3/4)	Ø 41.3(1-5/8)
< 184.8(630,700)	Ø 22.2(7/8)	Ø 44.5(1-3/4)
≤ 252.0 (859,600)	Ø 22.2(7/8)	Ø 53.98(2-1/8)

Total pipe length = A+B+C+D+a+b+c+d+e ≤ 1,000 m

L	Longest pipe length	Equivalent pipe length
	A+B+C+D+e ≤ 165 m	*A+B+C+D+e ≤ 190 m
l	Longest pipe length after 1st branch	
	B+C+D+e ≤ 40 m(90 m**)	
H	Difference in height (Outdoor Unit ↔ Indoor Unit)	
	H ≤ 90 m	
h	Difference in height (Indoor Unit ↔ Indoor Unit)	
	h ≤ 30 m	
h1	Difference in height (Outdoor Unit ↔ Outdoor Unit)	
	h1 ≤ 5 m	

- * : Assume equivalent piping length of Y branch to be 0.5 m, that of header to be 1 m, calculation purpose.
- ** : To apply Conditional Application

 **WARNING**

When the any one (or both) of below conditions are satisfied, the diameter of main pipe (A) must be increased according to below table.

- The equivalent length between outdoor unit and the farthest indoor unit is 90m or more (Liquid and Gas pipes are increased)
- The level difference (Outdoor unit ↔ Indoor unit) is 50 m or more (Only liquid pipe is increased)

(Table 2) Refrigerant pipe diameter from outdoor unit to first branch. (A)

Upward Outdoor unit total capacity	Standard Pipe Diameter		Increased Pipe Diameter			
			When equivalent pipe length is 90 m or more from ODU to farthest IDU		When level difference is 50 m or more	
HP	Liquid pipe [mm(inch)]	Gas pipe [mm(inch)]	Liquid pipe [mm(inch)]	Gas pipe [mm(inch)]	Liquid pipe [mm(inch)]	Gas pipe [mm(inch)]
8	Ø 9.52(3/8)	Ø 19.05(3/4)	Ø 12.7(1/2)	Ø 22.2(7/8)	Ø 12.7(1/2)	not increased
10	Ø 9.52(3/8)	Ø 22.2(7/8)	Ø 12.7(1/2)	Ø 25.4(1)	Ø 12.7(1/2)	not increased
12 ~ 14	Ø 12.7(1/2)	Ø 28.58(1-1/8)	Ø 15.88(5/8)	not increased	Ø 15.88(5/8)	not increased
16	Ø 12.7(1/2)	Ø 28.58(1-1/8)	Ø 15.88(5/8)	Ø 31.8(1-1/4)	Ø 15.88(5/8)	not increased
18 ~ 22	Ø 15.88(5/8)	Ø 28.58(1-1/8)	Ø 19.05(3/4)	Ø 31.8(1-1/4)	Ø 19.05(3/4)	not increased
24	Ø 15.88(5/8)	Ø 34.9(1-3/8)	Ø 19.05(3/4)	not increased	Ø 19.05(3/4)	not increased
26 ~ 34	Ø 19.05(3/4)	Ø 34.9(1-3/8)	Ø 22.2(7/8)	Ø 38.1(1-1/2)	Ø 22.2(7/8)	not increased
36 ~ 60	Ø 19.05(3/4)	Ø 41.3(1-5/8)	Ø 22.2(7/8)	not increased	Ø 22.2(7/8)	not increased
62 ~ 64	Ø 22.2(7/8)	Ø 44.5(1-3/4)	Ø 25.4(1)	Ø 53.98(2-1/8)	Ø 25.4(1)	not increased
66 ~ 88	Ø 22.2(7/8)	Ø 53.98(2-1/8)	Ø 25.4(1)	not increased	Ø 25.4(1)	not increased

(Table 3) Refrigerant pipe diameter from first branch to last branch (B,C,D)

Downward indoor unit total capacity [kW(Btu/h)]	Liquid pipe [mm(inch)]	Gas pipe [mm(inch)]
≤ 5.6(19,100)	Ø6.35(1/4)	Ø12.7(1/2)
< 16.0 (54,600)	Ø9.52(3/8)	Ø15.88(5/8)
≤ 22.4 (76,400)	Ø9.52(3/8)	Ø19.05(3/4)
< 33.6 (114,700)	Ø9.52(3/8)	Ø22.2(7/8)
< 50.4 (172,000)	Ø12.7(1/2)	Ø28.58(1-1/8)
< 67.2 (229,400)	Ø15.88(5/8)	Ø28.58(1-1/8)
< 72.8(248,500)	Ø15.88(5/8)	Ø34.9(1-3/8)
< 100.8(344,000)	Ø19.05(3/4)	Ø34.9(1-3/8)
< 173.6(592,500)	Ø19.05(3/4)	Ø41.3(1-5/8)
< 184.8(630,700)	Ø22.2(7/8)	Ø44.5(1-3/4)
≤ 252.0(859,600)	Ø22.2(7/8)	Ø53.98(2-1/8)

(Table 4) Conditional Application

- To satisfy below condition to make 40 m ~ 90 m of pipe length after first branch.

	Condition	Example	
1	Diameter of pipes between first branch and the last branch should be increased by one step, except pipe diameter B,C,D is same as Diameter A	$\varnothing 6.35 \rightarrow \varnothing 9.52, \varnothing 9.52 \rightarrow \varnothing 12.7,$ $\varnothing 12.7 \rightarrow \varnothing 15.88, \varnothing 15.88 \rightarrow \varnothing 19.05,$ $\varnothing 19.05 \rightarrow \varnothing 22.2, \varnothing 22.2 \rightarrow \varnothing 25.4,$ $\varnothing 25.4 \rightarrow \varnothing 28.58, \varnothing 28.58 \rightarrow \varnothing 31.8,$ $\varnothing 31.8 \rightarrow \varnothing 34.9, \varnothing 34.9 \rightarrow \varnothing 38.1$	
2	While calculating whole refrigerant pipe length, pipe B,C,D length should be calculated twice.		
3	Length of pipe from each indoor unit to the closest branch		$a, b, c, d, e \leq 40 \text{ m}$
4	Length of pipe from outdoor unit to the farthest indoor unit 5 $(A+B+C+D+E) - [\text{Length of pipe outdoor unit to the closest indoor unit } 1 (A+a)] \leq 40 \text{ m}$		$(A+B+C+D+E) - (A+a) \leq 40 \text{ m}$

! WARNING

- In case of pipe diameter B connected after first branch is bigger than the main pipe diameter A, B should be of the same size with A.

Ex) In case indoor unit combination ratio 120% is connected to 24 HP(67.2 kW) outdoor unit.

- Outdoor unit main pipe diameter A : $\varnothing 34.9$ (Gas pipe), $\varnothing 15.88$ (liquid pipe)
- Pipe diameter B after first branch according to 120% indoor unit ombination(80.6 kW) : $\varnothing 34.9$ (gas pipe), $\varnothing 19.05$ (liquid pipe)

Therefore, pipe diameter B connected after first branch would be $\varnothing 34.9$ (gas pipe) / $\varnothing 15.88$ (liquid pipe) which is same with main pipe diameter.

! WARNING

Pipe length after header branching (a~e)

It is recommended that difference in length of the pipes connected to the Indoor Units is minimized. Performance difference between Indoor Units may occur.

Outdoor unit Connection

! WARNING

- In case of pipe diameter B connected after first branch is bigger than the main pipe diameter A, B should be of the same size with A.
- EX) In case indoor unit combination ratio 120% is connected to 24HP(67.2 kW) outdoor unit.
- 1) Outdoor unit main pipe diameter A : Ø34.9(Gas pipe), Ø15.88(liquid pipe)
 - 2) Pipe diameter B after first branch according to 120% indoor unit ombination(80.6 kW) : Ø34.9(gas pipe), Ø19.05(liquid pipe)
- Therefore, pipe diameter B connected after first branch would be Ø34.9(gas pipe) / Ø15.88(liquid pipe) which is same with main pipe diameter.

[Example]

Do not choose the main pipe diameter by downward indoor unit total capacity but its outdoor unit model name.

Do not let the connection pipe from branch to branch exceed the main pipe diameter chosen by outdoor unit model name.

EX) Where connecting the indoor units to the 22 HP (61.6 kW) outdoor unit to 130% of its system capacity (80.1 kW) and branching 7k (2.2 kW) indoor unit at the 1st branch.

- 1) Main pipe diameter(22 HP outdoor unit): Ø28.58(gas pipe), Ø15.88(Liquid pipe)
- 2) Pipe diameter between 1st and 2nd branch (77.9kW indoor units) : Ø34.9(Gas pipe), Ø19.05(Liquid pipe) in conformity with downward indoor units.

Since the main pipe diameter of 22HP outdoor unit is Ø28.58(gas pipe), Ø15.88(Liquid pipe) is used as the main pipe and the connection pipe between 1st and 2nd branch.

Indoor Unit Connection

Indoor Unit connecting pipe from branch (a,b,c,d,e)

Indoor Unit capacity [kW(Btu/h)]	Liquid pipe [mm(inch)]	Gas pipe [mm(inch)]
≤ 5.6(19,100)	Ø 6.35(1/4)	Ø 12.7(1/2)
< 16.0(54,600)	Ø 9.52(3/8)	Ø 15.88(5/8)
≤ 22.4(76,400)	Ø 9.52(3/8)	Ø 19.05(3/4)
≤ 28.0(95,900)	Ø 9.52(3/8)	Ø 22.2(7/8)

! CAUTION

- Bending radius should be at least twice the diameter of the pipe.
- Bend pipe after 500 mm or more from branch (or header).
Do not bend U type.
It may cause Performance unsatisfactory or noise.
- If want U type, bending R is more than 200 mm.

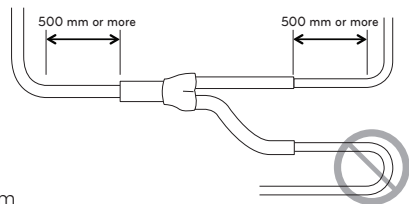

Pipe Connection Method/Precautions for Series connections between Outdoor units

- Separate Y branch joints are needed for series connections between outdoor units.
- Please refer to the below connection examples to install pipe connections between outdoor units.

Pipe connection between outdoor units (General Case)

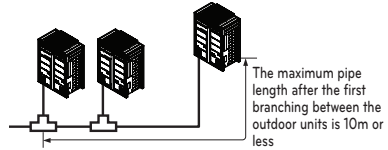

Pipes between outdoor units are 2 m or less

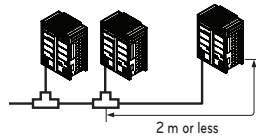

Pipes between outdoor units are 2 m or longer

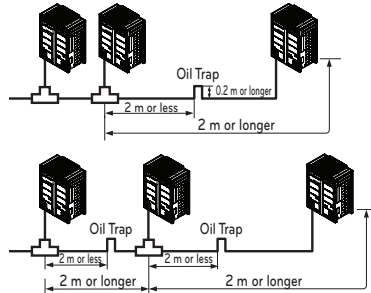

- If the distance between the outdoor units becomes more than 2 m, apply Oil Traps between the gas pipes.
- If the outdoor unit is located lower than the main pipe, apply Oil Trap.

Examples of Wrong Pipe Connections

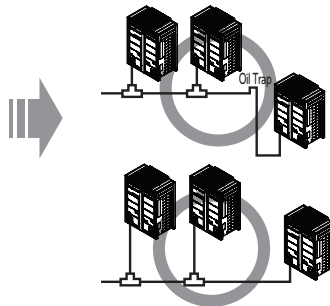
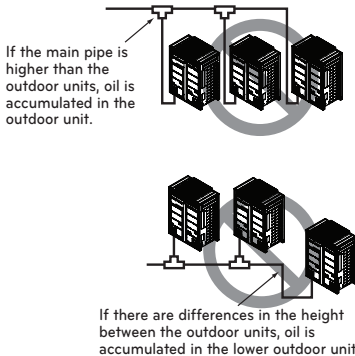

- The pipes between the outdoor units must maintain horizontal levelness or give an inclination to prevent a back flow toward the slave outdoor unit. Otherwise, the unit may not operate properly.

(Example 1)

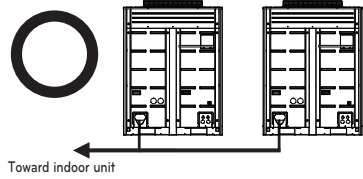
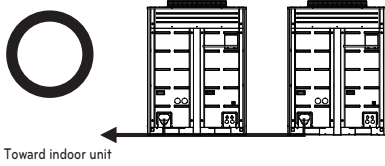

(Example 2)

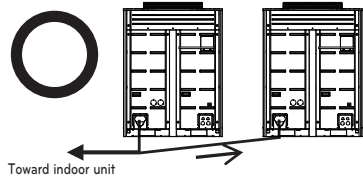
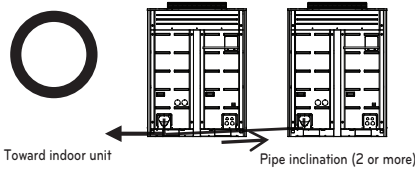

(Example 3)

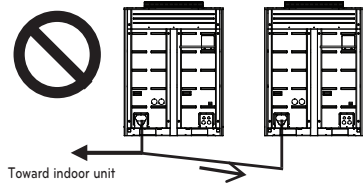
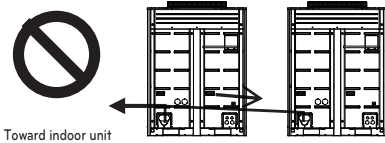

- Apply Oil Trap as shown below when the length of the pipe between the outdoor units is more than 2 m. Otherwise, the unit may not operate properly.

(Example 1)

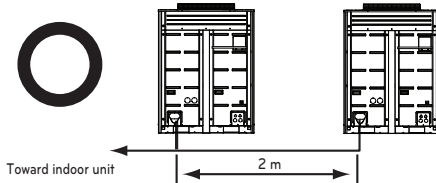

(Example 2)

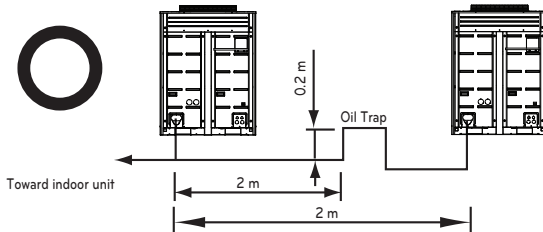

- When connecting the pipes between the outdoor units, the accumulation of oil in the slave outdoor unit should be avoided. Otherwise, the unit may not operate properly.

(Example 1)

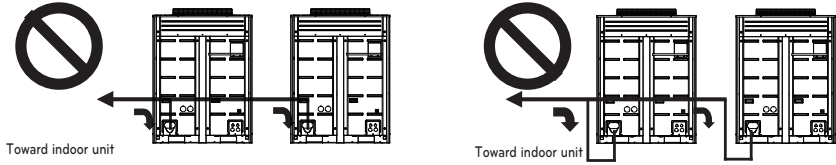

(Example 2)

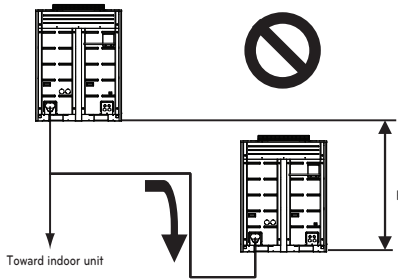

(Example 3)

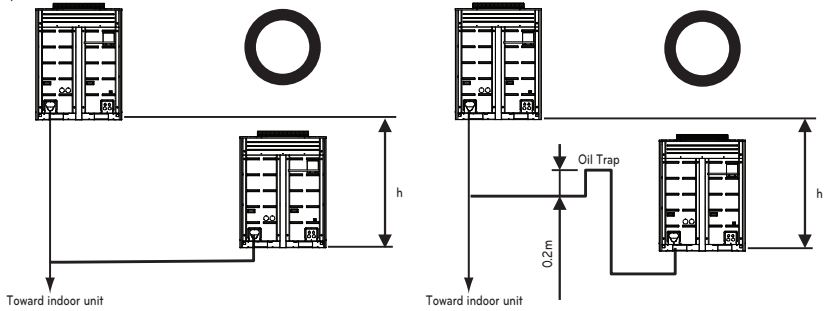

The amount of Refrigerant

The calculation of the additional charge should take into account the length of pipe and CF(correction Factor) value of indoor unit.

Additional charge(kg)	=	Total liquid pipe : Ø 25.4 mm	x 0.480 (kg/m)
	+	Total liquid pipe : Ø 22.2 mm	x 0.354 (kg/m)
	+	Total liquid pipe : Ø 19.05 mm	x 0.266 (kg/m)
	+	Total liquid pipe : Ø 15.88 mm	x 0.173 (kg/m)
	+	Total liquid pipe : Ø 12.7 mm	x 0.118 (kg/m)
	+	Total liquid pipe : Ø 9.52 mm	x 0.061 (kg/m)
	+	Total liquid pipe : Ø 6.35 mm	x 0.022 (kg/m)
	+	CF value of indoor unit	

Amount refrigerant of Indoor units

Example) 4Way Ceiling Cassette 14.5 kW -1ea, Ceiling concealed Duct 7.3 kW-2ea,
Wall Mounted 2.3 kW-4ea
CF = 0.64 × 1 + 0.26 × 2 + 0.24 × 4 = 2.12 kg

Attach the additional refrigerant table of IDU.

CAUTION

Do not use 0 or 1 series of indoor unit. ex) ARNU****0(X) , ARNU****1(X)

! WARNING

- Regulation for refrigerant leakage
: the amount of refrigerant leakage should satisfy the following equation for human safety.

$$\frac{\text{Total amount of refrigerant in the system}}{\text{Volume of the room at which Indoor Unit of the least capacity is installed}} \leq 0.44 \text{ (kg / m}^3\text{)}$$

If the above equation can not be satisfied, then follow the following steps.

- Selection of air conditioning system: select one of the next
 - Installation of effective opening part
 - Reconfirmation of Outdoor Unit capacity and piping length
 - Reduction of the amount of refrigerant
 - Installation of 2 or more security device (alarm for gas leakage)
- Change Indoor Unit type
: installation position should be over 2 m from the floor (Wall mounted type → Cassette type)
- Adoption of ventilation system
: choose ordinary ventilation system or building ventilation system
- Limitation in piping work
: Prepare for earthquake and thermal stress

Refrigerant charging

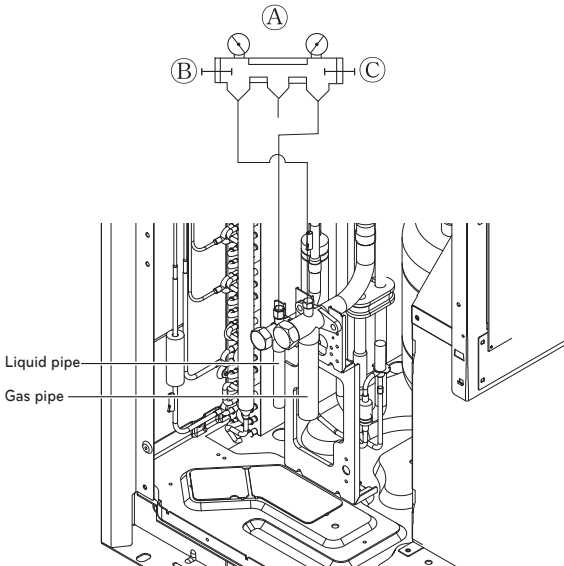

- Ⓐ Manifold Gauge
- Ⓑ Low pressure side Handle
- Ⓒ High pressure side Handle

! WARNING

- Pipe to be vacuumed : gas pipe, liquid pipe
- If the refrigerant amount is not exact, it may not operate properly.
- If additionally bottled refrigerant amount is over 10%, condenser burst or insufficient indoor unit performance may be caused.

Distribution Method

Horizontal Distribution

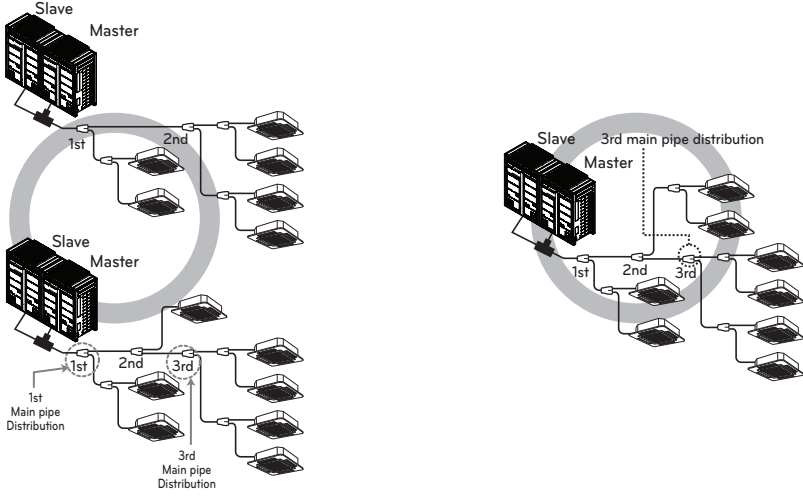

Vertical Distribution

- Ensure that the branch pipes are attached vertically.

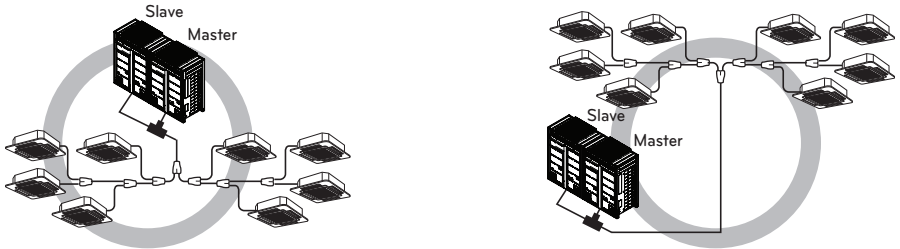

The others

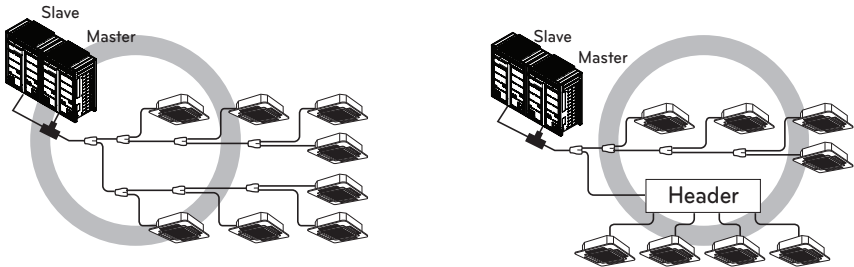

Branch pipe Fitting

Y branch

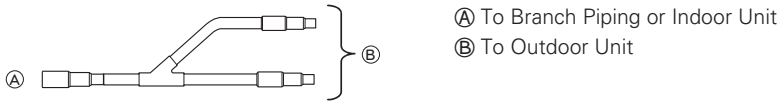

- Ensure that the branch pipes are attached horizontally or vertically (see the diagram below.)

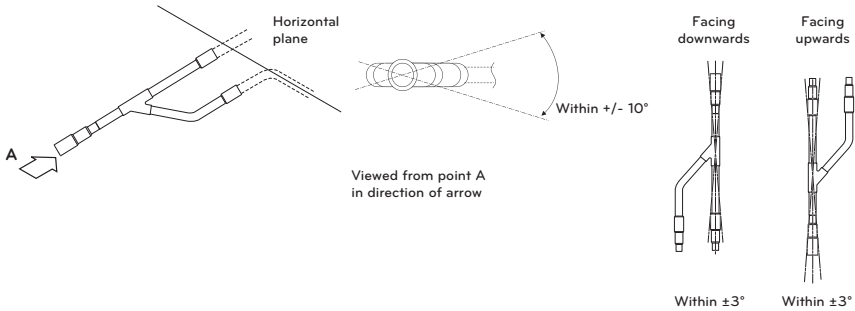

- There is no limitation on the joint mounting configuration.
- If the diameter of the refrigerant piping selected by the procedures described is different from the size of the joint, the connecting section should be cut with a pipe cutter.
- Branch pipe should be insulated with the insulator in each kit.

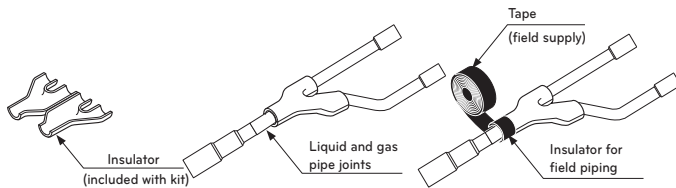

Header

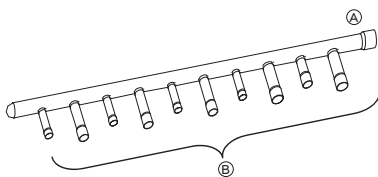

Ⓐ To Outdoor Unit Ⓑ To Indoor Unit

- The indoor unit having larger capacity must be installed closer to Ⓐ than smaller one.
- If the diameter of the refrigerant piping selected by the procedures described is different from the size of the joint, the connecting section should be cut with a pipe cutter.

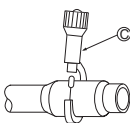

Ⓒ Pipe cutter

- When the number of pipes to be connected is smaller than the number of header branches, install a cap to the unconnected branches.

44 PIPE CONNECTIONS BETWEEN INDOOR AND OUTDOOR UNIT

- When the number of indoor units to be connected to the branch pipes is less than the number of branch pipes available for connection then cap pipes should be fitted to the surplus branches.

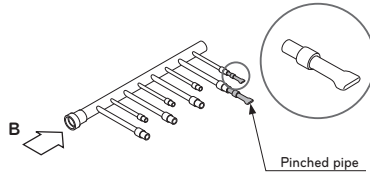

- Fit branch pipes lie in a horizontal plane.

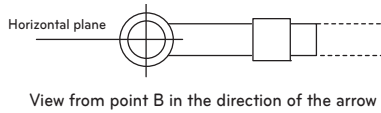

- Header should be insulated with the insulator in each kit.

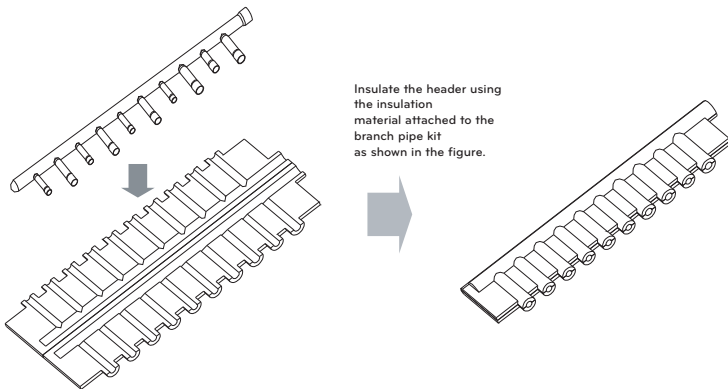

- Joints between branch and pipe should be sealed with the tape included in each kit.

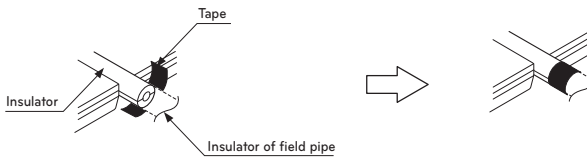

- Any cap pipe should be insulated using the insulator provided with each kit and then taped as described above.

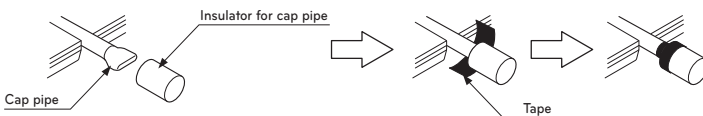

[unit:mm]

Y branch pipe

Models	Gas pipe	Liquid pipe
ARBLN01621		
ARBLN03321		
ARBLN07121		
ARBLN14521		
ARBLN23220		

Header

[unit:mm]

Models	Gas pipe	Liquid pipe
4 branch ARBL054		
7 branch ARBL057		
4 branch ARBL104		
7 branch ARBL107		
10 branch ARBL1010		
10 branch ARBL2010		

Leak Test and Vacuum drying

Leak test

Leak test should be made by pressurizing nitrogen gas to 3.8 MPa(38.7 kgf/cm²). If the pressure does not drop for 24 hours, the system passes the test. If the pressure drops, check where the nitrogen leaks. For the test method, refer to the following figure. (Make a test with the service valves closed. Be also sure to pressurize liquid pipe, gas pipe and high/low pressure common pipe)

The test result can be judged good if the pressure has not been reduced after leaving for about one day after completion of nitrogen gas pressurization.

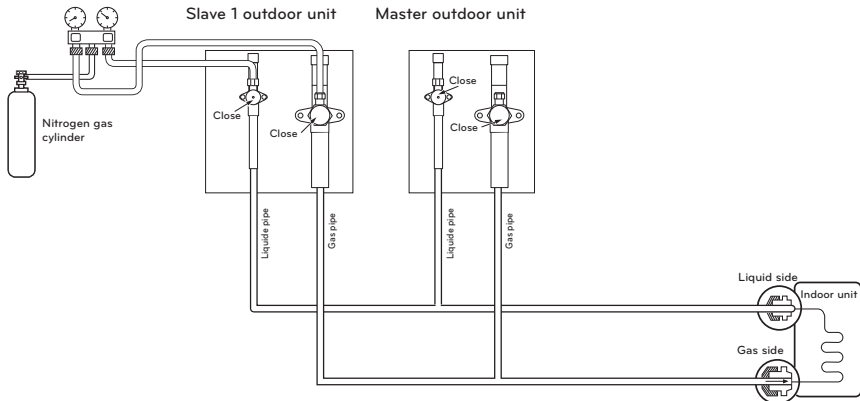

! WARNING

Use a vacuum pump or Inert(nitrogen) gas when doing leakage test or air purge. Do not compress air or Oxygen and do not use Flammable gases. Otherwise, it may cause fire or explosion.

- There is the risk of death, injury, fire or explosion.

! NOTE

If the ambient temperature differs between the time when pressure is applied and when the pressure drop is checked, apply the following correction factor

There is a pressure change of approximately 0.1 kg/cm² (0.01 MPa) for each 1 °C of temperature difference.

Correction= (Temp. at the time of pressurization – Temp. at the time of check) X 0.1

For example: Temperature at the time of pressurization (3.8 MPa) is 27 °C

24 hour later: 3.73 MPa, 20 °C

In this case the pressure drop of 0.07 is because of temperature drop

And hence there is no leakage in pipe occurred.

! CAUTION

To prevent the nitrogen from entering the refrigeration system in the liquid state, the top of the cylinder must be at higher position than the bottom when you pressurize the system.

Usually the cylinder is used in a vertical standing position.

Vacuum

Vacuum drying should be made from the service port provided on the outdoor unit's service valve to the vacuum pump commonly used for liquid pipe, gas pipe and high/low pressure common pipe. (Make Vacuum from liquid pipe, gas pipe and high/low pressure common pipe with the service valve closed.)

* Never perform air purging using refrigerant.

- Vacuum drying: Use a vacuum pump that can evacuate to -100.7 kPa (5 Torr, -755 mmHg).
- Evacuate the system from the liquid and gas pipes with a vacuum pump for over 2 hrs and bring the system to -100.7 kPa . After maintaining system under that condition for over 1 hr, confirm the vacuum gauge rises. The system may contain moisture or leak.
- Following should be executed if there is a possibility of moisture remaining inside the pipe. (Rainwater may enter the pipe during work in the rainy season or over a long period of time) After evacuating the system for 2 hrs, give pressure to the system to 0.05 MPa (vacuum break) with nitrogen gas and then evacuate it again with the vacuum pump for 1hr to -100.7 kPa (vacuum drying). If the system cannot be evacuated to -100.7 kPa within 2 hrs, repeat the steps of vacuum break and its drying. Finally, check if the vacuum gauge does not rise or not, after maintaining the system in vacuum for 1 hr.

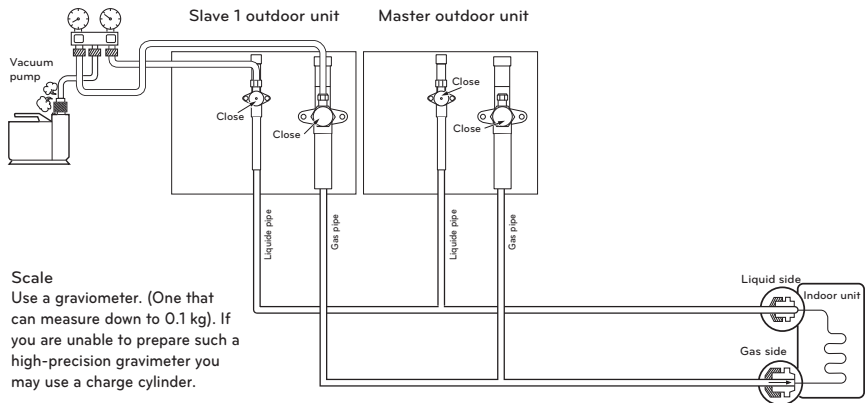

Scale

Use a gravimeter. (One that can measure down to 0.1 kg). If you are unable to prepare such a high-precision gravimeter you may use a charge cylinder.

⚠ WARNING

Use a vacuum pump or Inert(nitrogen) gas when doing leakage test or air purge. Do not compress air or Oxygen and do not use Flammable gases. Otherwise, it may cause fire or explosion.

- There is the risk of death, injury, fire or explosion.

ⓘ NOTE

Always add an appropriate amount of refrigerant. (For the refrigerant additional charge) Too much or too little refrigerant will cause trouble.

To use the Vacuum Mode

(If the Vacuum mode is set, all valves of Indoor units and Outdoor units will be opened.)

⚠ WARNING

When installing and moving the air conditioner to another site, recharge after perfect evacuation.

- If a different refrigerant or air is mixed with the original refrigerant, the refrigerant cycle may malfunction and the unit may be damaged.

Vacuum Mode

This function is used for creating vacuum in the system after compressor replacement, ODU parts replacement or IDU addition/replacement.

Vacuum mode setting method

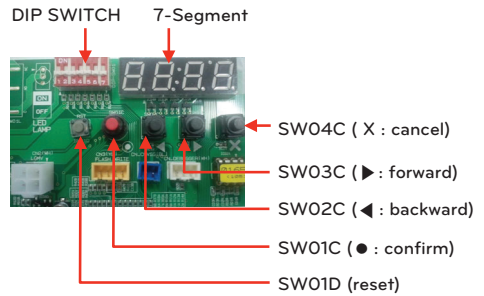
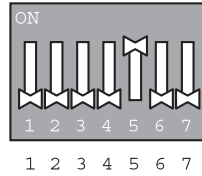
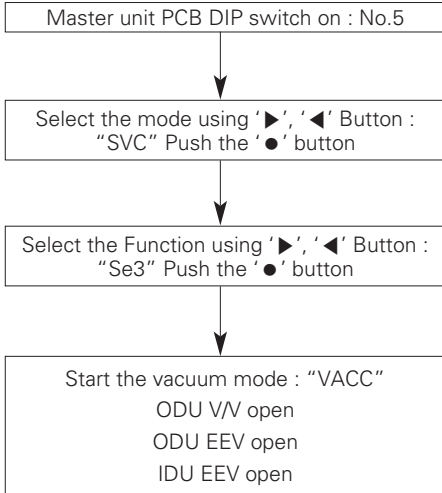

Vacuum mode off method

Dip switch off and push the reset button on Master unit PCB

! CAUTION

ODU operation stops during vacuum mode. Compressor can't operate.

Heat insulation of refrigerant piping

Be sure to give insulation work to refrigerant piping by covering liquid pipe and gas pipe separately with enough thickness heat-resistant polyethylene, so that no gap is observed in the joint between indoor unit and insulating material, and insulating materials themselves. When insulation work is insufficient, there is a possibility of condensation drip, etc. Pay special attention to insulation work to ceiling plenum.

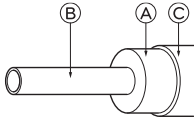

- Ⓐ Heat insulation material
- Ⓑ Pipe
- Ⓒ Outer covering (Wind the connection part and cutting part of heat insulation material with a finishing tape.)

Heat insulation material	Adhesive + Heat - resistant polyethylene foam + Adhesive tape	
Outer covering	Indoor	Vinyl tape
	Floor exposed	Water-proof hemp cloth + Bronze asphalt
	Outdoor	Water-proof hemp cloth + Zinc plate + Oily paint

NOTE

When using polyethylene cover as covering material, asphalt roofing shall not be required.

Bad example	<p>• Do not insulate gas or low pressure pipe and liquid or high pressure pipe together.</p> <ul style="list-style-type: none"> Ⓐ Liquid pipe Ⓑ Gas pipe Ⓒ Power cables Ⓓ Finishing tape Ⓔ Insulating material Ⓕ Communication cables 	<p>• Be sure to fully insulate connecting portion.</p> <p>Ⓐ These parts are not insulated.</p>
Good example	<ul style="list-style-type: none"> Ⓐ Liquid pipe Ⓑ Gas pipe Ⓒ Power cables Ⓓ Communication cables Ⓔ Insulating material <p>Power cables Communication cables</p> <p>Separation</p>	

Penetrations

Inner wall (concealed)

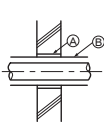

Outer wall

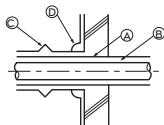

Outer wall (exposed)

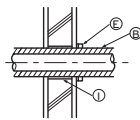

Floor (fireproofing)

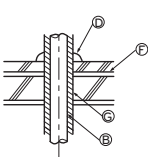

Penetrating portion on fire limit and boundary wall

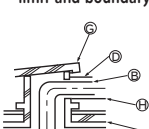

Roof pipe shaft

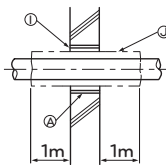

- Ⓐ Sleeve
- Ⓑ Heat insulating material
- Ⓒ Lagging
- Ⓓ Caulking material
- Ⓔ Band
- Ⓕ Waterproofing layer
- Ⓖ Sleeve with edge
- Ⓗ Lagging material
- Ⓙ Mortar or other incombustible caulking
- Ⓚ Incombustible heat insulation material

When filling a gap with mortar, cover the penetration part with steel plate so that the insulation material will not be caved in. For this part, use incombustible materials for both insulation and covering. (Vinyl covering should not be used.)

ELECTRICAL WIRING

CAUTION

- Follow ordinance of your governmental organization for technical standard related to electrical equipment, wiring regulations and guidance of each electric power company.

! WARNING

Be sure to have authorized electrical engineers do the electric work using special circuits in accordance with regulations and this installation manual. If power supply circuit has a lack of capacity or electric work deficiency, it may cause an electric shock or fire.

- Install the Outdoor Unit communication cable away from the power source wiring so that it is not affected by electric noise from the power source. (Do not run it through the same conduit.)
- Be sure to provide designated grounding work to Outdoor Unit.

! CAUTION

Be sure to correct the outdoor unit to earth. Do not connect ground wire to any gas pipe, liquid pipe, lightning rod or telephone earth line. If earth is incomplete, it may cause an electric shock.

- Give some allowance to wiring for electrical part box of Indoor and Outdoor Units, because the box is sometimes removed at the time of service work.
- Never connect the main power source to terminal block of communication cable. If connected, electrical parts will be burnt out.
- Use 2-core shield cable for communication cable. (O mark in the figure below) If communication cable of different systems are wired with the same multicore cable, the resultant poor transmitting and receiving will cause erroneous operations. (⊗ mark in the figure below)
- Only the communication cable specified should be connected to the terminal block for Outdoor Unit communication.

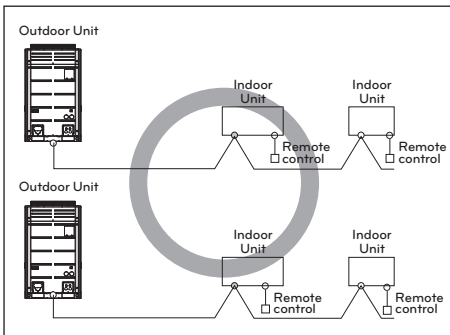

2-Core Shield Cable

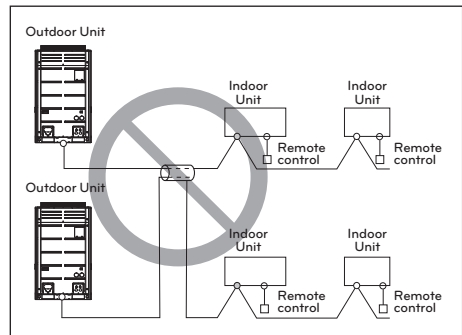

Multi-Core Cable

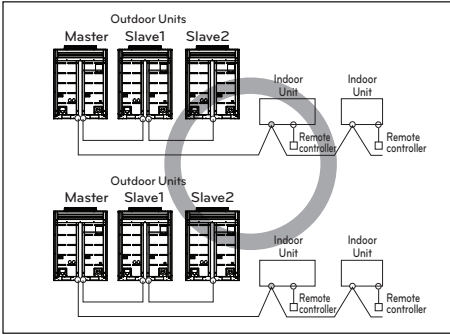

2-Core Shield Cable

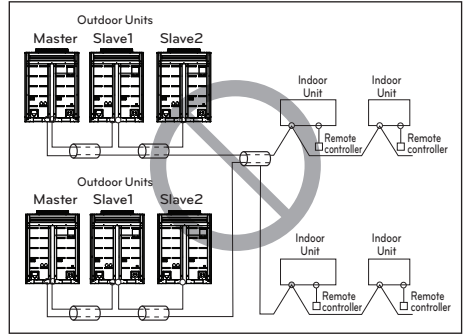

Multi-Core Cable

CAUTION

- Use the 2-core shield cables for communication cables. Never use them together with power cables.
- The conductive shielding layer of cable should be grounded to the metal part of both units.
- Never use multi-core cable
- As this unit is equipped with an inverter, to install a phase leading capacitor not only will deteriorate power factor improvement effect, but also may cause capacitor abnormal heating. Therefore, never install a phase leading capacitor.
- Make sure that the power unbalance ratio is not greater than 2%. If it is greater the units lifespan will be reduced.

Precautions when laying power wiring

Use round pressure terminals for connections to the power terminal block.

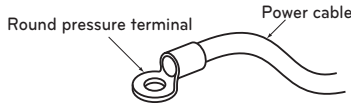

When none are available, follow the instructions below.

- Do not connect wiring of different thicknesses to the power terminal block. (Slack in the power wiring may cause abnormal heat.)
- When connecting cable which is the same thickness, do as shown in the figure below.

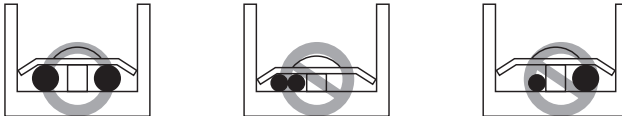

- For wiring, use the designated power cable and connect firmly, then secure to prevent outside pressure being exerted on the terminal block.
- Use an appropriate screwdriver for tightening the terminal screws. A screwdriver with a small head will strip the head and make proper tightening impossible.
- Over-tightening the terminal screws may break them.

CAUTION

When the 400 volt power supply is applied to "N" phase by mistake, check damaged parts in control box and replace them.

Control box and connecting position of wiring

- Remove all of the screws at front panel and remove the panel by pulling it forward.
- Connect communication cable between Master and Slave outdoor unit through the terminal block.
- Connect communication cables between outdoor unit and indoor units through the terminal block.
- When the central control system is connected to the outdoor unit, a dedicated PCB must be connected between them.
- When connecting communication cable between outdoor unit and indoor units with shielded cable, connect the shield ground to the earth screw.

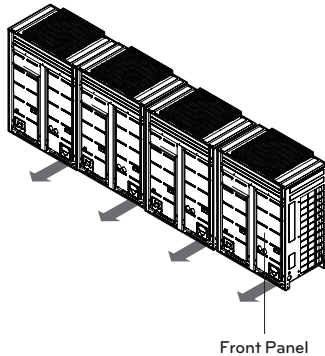

! WARNING

- The temperature sensor for outdoor air should not be exposed to direct sunlight.
- Provide an appropriate cover to intercept direct sunlight.

[Heat pump]

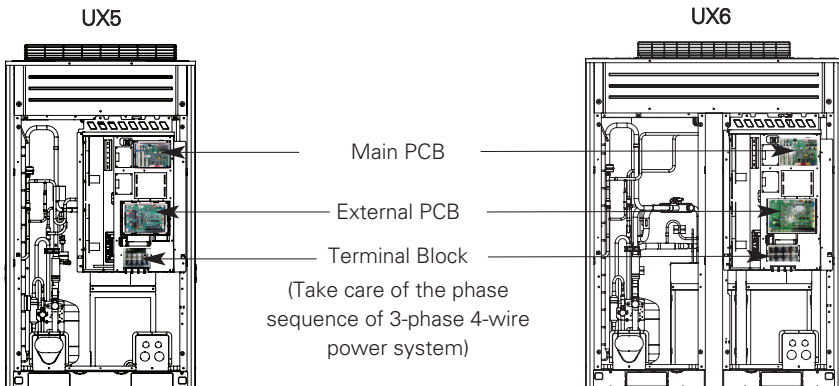

Communication and Power Cables

Communication cable

- Types : shielding cable
- Cross section : 1.0~1.5 mm²
- Maximum allowable temperature: 60 °C
- Maximum allowable cable length: under 1000 m

Remote control cable

- Types : 3-core cable

Central control cable

Product type	Cable type	Diameter
ACP	2-core cable (Shielding cable)	1.0~1.5 mm ²
AC Smart	2-core cable (Shielding cable)	1.0~1.5 mm ²
AC Ez	4-core cable (Shielding cable)	1.0~1.5 mm ²

Separation of communication and power cables

- If communication and power cables are run alongside each other then there is a strong likelihood of operational faults developing due to interference in the signal wiring caused by electrostatic and electromagnetic coupling.

The tables below indicates our recommendation as to appropriate spacing of communication and power cables where these are to be run side by side

Current capacity of power cable	Spacing	
100V or more	10 A	300 mm
	50 A	500 mm
	100 A	1000 mm
	Exceed 100 A	1500 mm

NOTE

- The figures are based on assumed length of parallel cabling up to 100 m. For length in excess of 100 m the figures will have to be recalculated in direct proportion to the additional length of cable involved.
- If the power supply waveform continues to exhibit some distortion the recommended spacing in the table should be increased.
 - If the cable are laid inside conduits then the following point must also be taken into account when grouping various cable together for introduction into the conduits
 - Power cable(including power supply to air conditioner) and communication cables must not be laid inside the same
 - In the same way, when grouping the power wires and communication cables should not be bunched together.

CAUTION

If apparatus is not properly earthed then there is always a risk of electric shocks, the earthing of the apparatus must be carried out by a qualified person.

Wiring of main power supply and equipment capacity

- Use a separate power supply for the Outdoor Unit and Indoor Unit.
- Bear in mind ambient conditions (ambient temperature, direct sunlight, rain water, etc.) when proceeding with the wiring and connections.
- The cable size is the minimum value for metal conduit wiring. The power cord size should be 1 rank thicker taking into account the line voltage drops. Make sure the power-supply voltage does not drop more than 10%.
- Specific wiring requirements should adhere to the wiring regulations of the region.
- Power supply cords of parts of appliances for outdoor use should not be lighter than polychloroprene sheathed flexible cord.
- Don't install an individual switch or electrical outlet to disconnect each of indoor unit separately from the power supply.

WARNING

- Follow ordinance of your governmental organization for technical standard related to electrical equipment, wiring regulations and guidance of each electric power company.
- Make sure to use specified cables for connections so that no external force is imparted to terminal connections. If connections are not fixed firmly, it may cause heating or fire.
- Make sure to use the appropriate type of overcurrent protection switch. Note that generated overcurrent may include some amount of direct current.

CAUTION

- Some installation site may require attachment of an earth leakage breaker. If no earth leakage breaker is installed, it may cause an electric shock.
- Do not use anything other than breaker and fuse with correct capacity. Using fuse and wire or copper wire with too large capacity may cause a malfunction of unit or fire.

Field Wiring

Single outdoor unit

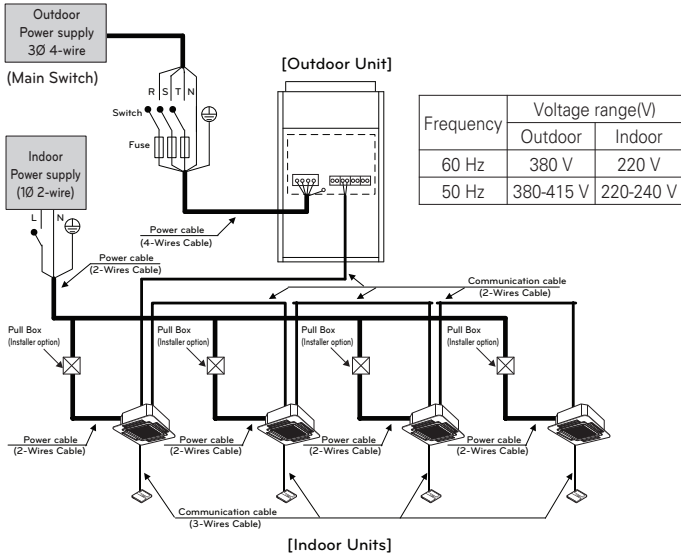

⚠ WARNING

- Indoor Unit ground wires are required for preventing electrical shock accident during current leakage, Communication disorder by noise effect and motor current leakage (without connection to pipe).
- Don't install an individual switch or electrical outlet to disconnect each of indoor unit separately from the power supply.
- Install the main switch that can interrupt all the power sources in an integrated manner because this system consists of the equipment utilizing the multiple power sources.
- If there exists the possibility of reversed phase, lose phase, momentary blackout or the power goes on and off while the product is operating, attach a reversed phase protection circuit locally. Running the product in reversed phase may break the compressor and other parts.

[Heat Pump]

Between Indoor and Master Outdoor unit

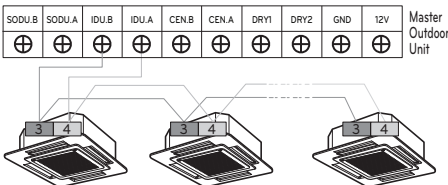

The GND terminal at the main PCB is a '-' terminal for day contact, it is not the point to make ground connection.

Series outdoor units

When the power source is connected In series between the units.

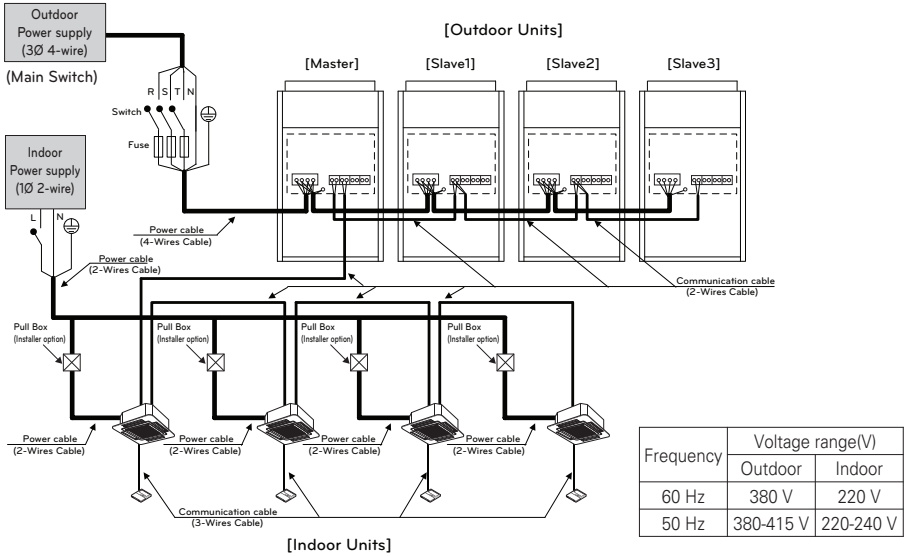

WARNING

When the total capacity is over than as follow, the power source do not use in series between the units.

The First terminal block could be burnt out. (Heat Pump : 68 Hp)

When the power source is supplied to each outdoor unit individually.

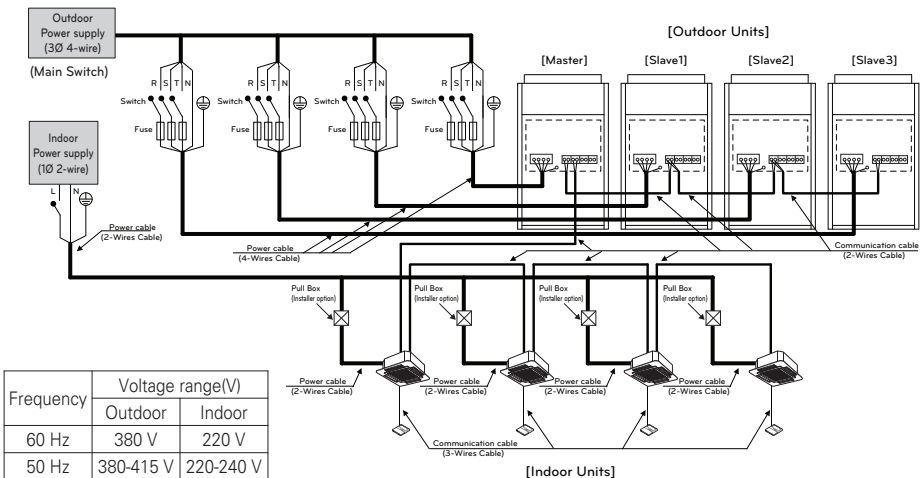

! WARNING

- Indoor Unit ground wires are required for preventing electrical shock accident during current leakage, Communication disorder by noise effect and motor current leakage (without connection to pipe).
- Don't install an individual switch or electrical outlet to disconnect each of indoor unit separately from the power supply.
- Install the main switch that can interrupt all the power sources in an integrated manner because this system consists of the equipment utilizing the multiple power sources.
- If there exists the possibility of reversed phase, lose phase, momentary blackout or the power goes on and off while the product is operating, attach a reversed phase protection circuit locally. Running the product in reversed phase may break the compressor and other parts.

[Heat Pump]

Between Indoor and Master Outdoor unit

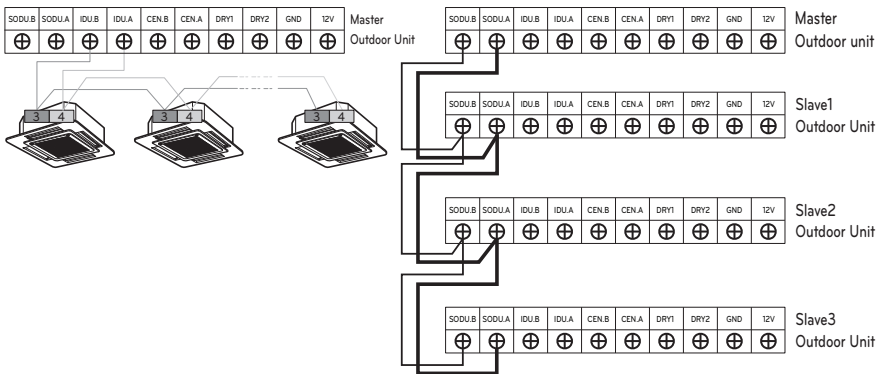

The GND terminal at the main PCB is a '-' terminal for dry contact.

It is not the point to make ground connection.

- Make sure that terminal number of master and slave outdoor units are matched.(A-A,B-B)

Example) Connection of transmission wire

[BUS type]

- Connection of communication cable must be installed like below figure between indoor unit to outdoor unit.

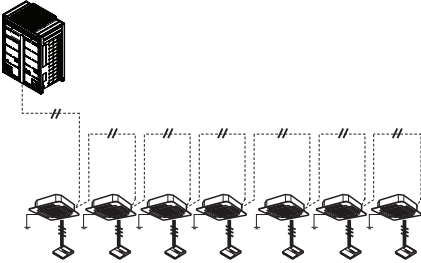

[STAR type]

- Abnormal operation can be caused by communication defect, when connection of communication cable is installed like below figure (STAR type).

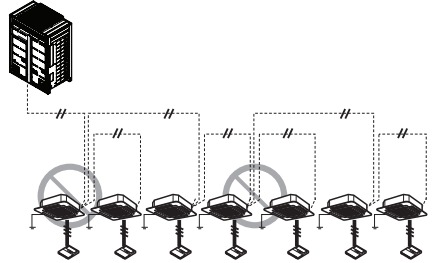

Example) Connection of power and communication cable (UX5)

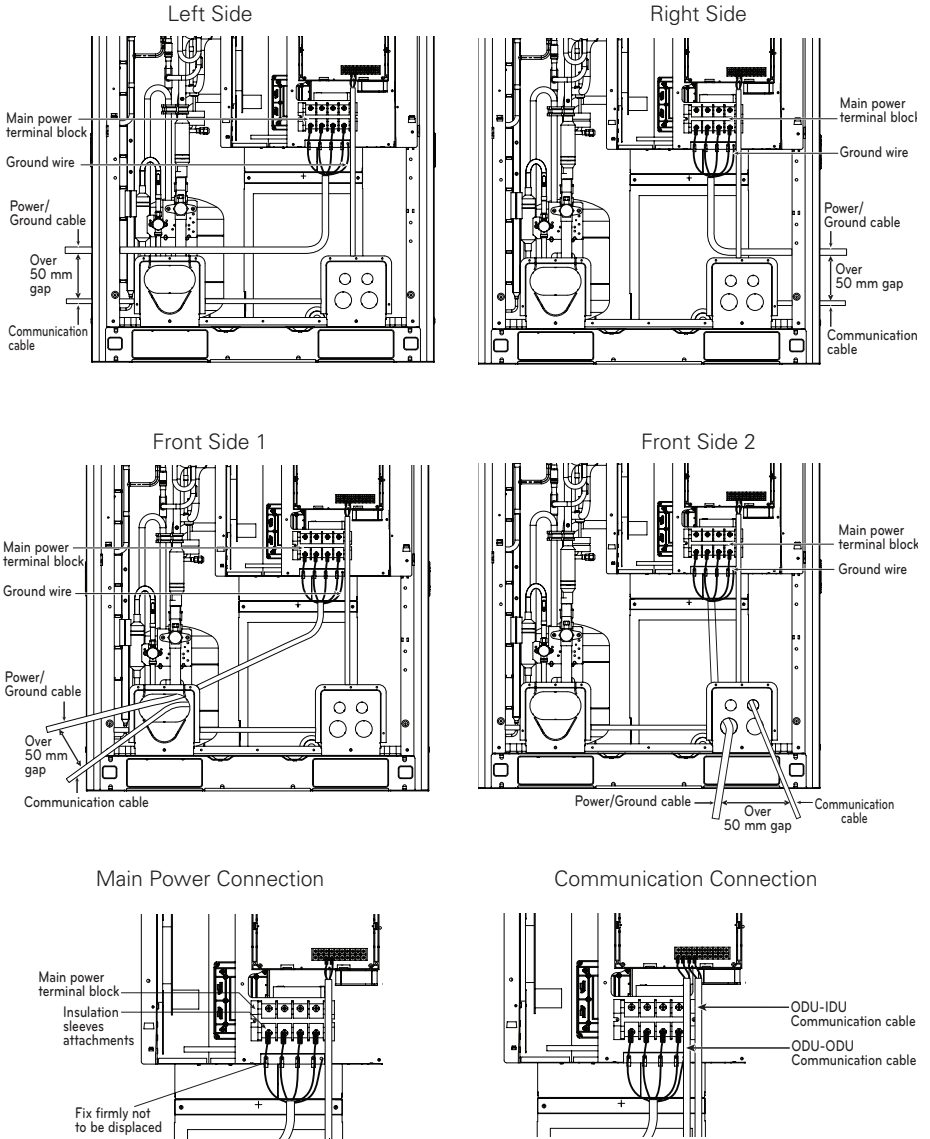

CAUTION

It should be wiring power cables or communication cables to avoid interference with the oil level sensor. Otherwise, That oil level sensor would be operated abnormally.

Example) Connection of power and communication cable (UX6)

Left Side

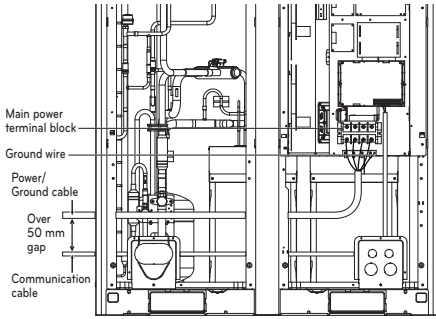

Right Side

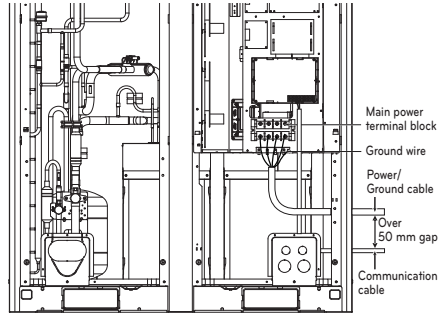

Front Side 1

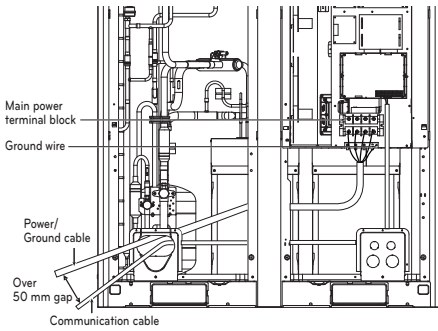

Front Side 2

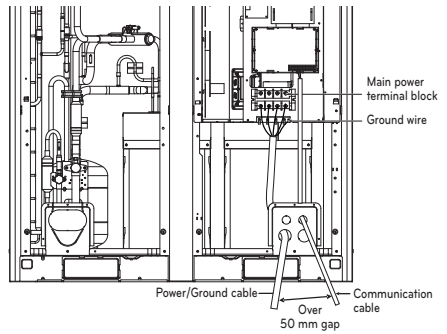

Main Power Connection

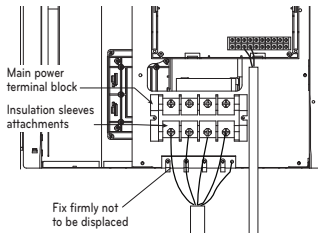

Communication Connection

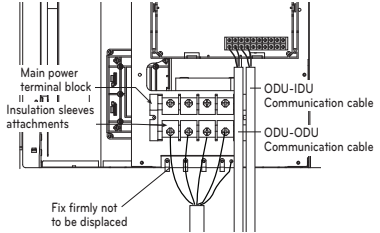

Example) Installation of IO Module

Installation Method

1. Separate front panel from outdoor unit.
2. Separate front cover of control box.
3. Assemble the IO Module with screws(12 mm*2EA) on designated location.
4. Connect the connection wires according to the instructions.
(Please refer to Setting and Using Method which is included in IO Module Installation Manual)

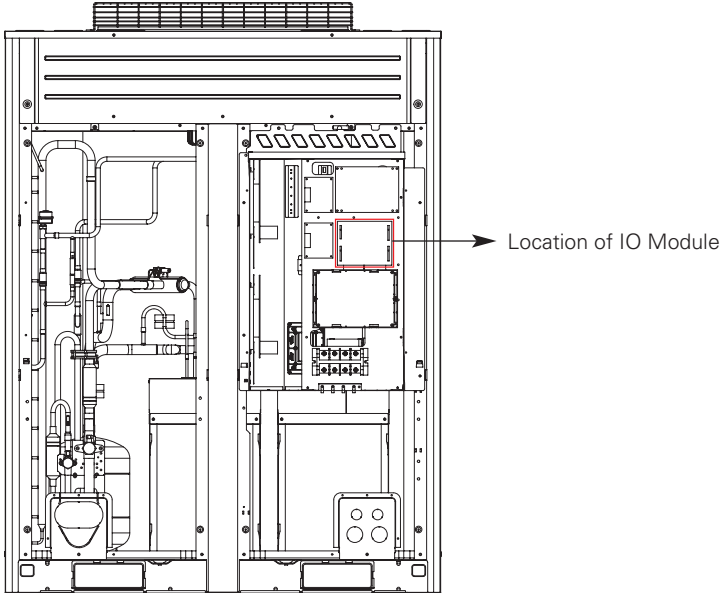

Checking the setting of outdoor units

Checking according to dip switch setting

- You can check the setting values of the Master outdoor unit from the 7 segment LED.
The dip switch setting should be changed when the power is OFF.

Checking the initial display

The number is sequentially appeared at the 7 segment in 5 seconds after applying the power.
This number represents the setting condition.

• Initial display order

Order	No	Mean
①	8~22	Master model capacity
②	10~22	Slave 1 model capacity
③	10~22	Slave 2 model capacity
④	10~22	Slave 3 model capacity
⑤	8~88	Total capacity
⑥	1	Cooling Only
	2	Heat Pump
	3	Heat Recovery
⑦	38	380 V model
	46	460 V model
	22	220 V model
⑧	1	LTE
	2	LTS / LTN
	9	LLS / LLN

• Master Unit

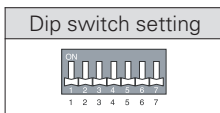

• Slave Unit

Dip switch setting	ODU Setting
	Slave 1
	Slave 2
	Slave 3

Group Number setting

Group Number setting for Indoor Units

- Confirm the power of whole system(Indoor Unit, Outdoor Unit) is OFF, otherwise turn off.
- The communication cables connected to CEN.A and CEN.B terminal should be connected to central control of Outdoor Unit with care for their polarity (A-A, B-B).
- Turn the whole system on.
- Set the group and Indoor Unit number with a wired remote control.
- To control several sets of Indoor Units into a group, set the group ID from 0 to F for this purpose.

Outdoor Units (External PCB)

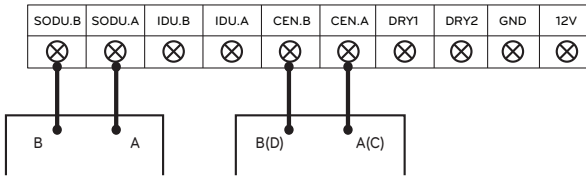

Example) Group number setting

1 E
 Group Indoor unit

1st number indicate the group number

2nd number point out indoor unit number

Group recognizing the central controller
No.0 group (00~0F)
No.1 group (10~1F)
No.2 group (20~2F)
No.3 group (30~3F)
No.4 group (40~4F)
No.5 group (50~5F)
No.6 group (60~6F)
No.7 group (70~7F)
No.8 group (80~8F)
No.9 group (90~9F)
No. A group (A0~AF)
No. B group (B0~BF)
No. C group (C0~CF)
No. D group (D0~DF)
No. E group (E0~EF)
No. F group (F0~FF)

Automatic Addressing

The address of indoor units would be set by Automatic Addressing

- Wait for 3 minutes after supplying power.
(Master and Slave outdoor units, indoor units)
- Press RED button of the outdoor units for 5 seconds. (SW01C)
- A "88" is indicated on 7-segment LED of the outdoor unit PCB.
- For completing addressing, 2~7 minutes are required depending on numbers of connected indoor units
- Numbers of connected indoor units whose addressing is completed are indicated for 30 seconds on 7-segment LED of the outdoor unit PCB
- After completing addressing, address of each indoor unit is indicated on the wired remote control display window. (CH01, CH02, CH03,, CH06 : Indicated as numbers of connected indoor units)

[Heat Pump (Main PCB)]

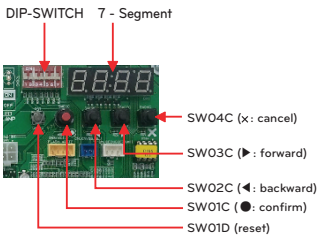

! CAUTION

- In replacement of the indoor unit PCB, always perform Automatic addressing setting again (At that time, please check about using Independent power module to any indoor unit.)
- If power supply is not applied to the indoor unit, operation error occur.
- Automatic Addressing is only possible on the master Unit.
- Automatic Addressing has to be performed after 3 minutes to improve communication.

The Procedure of Automatic Addressing

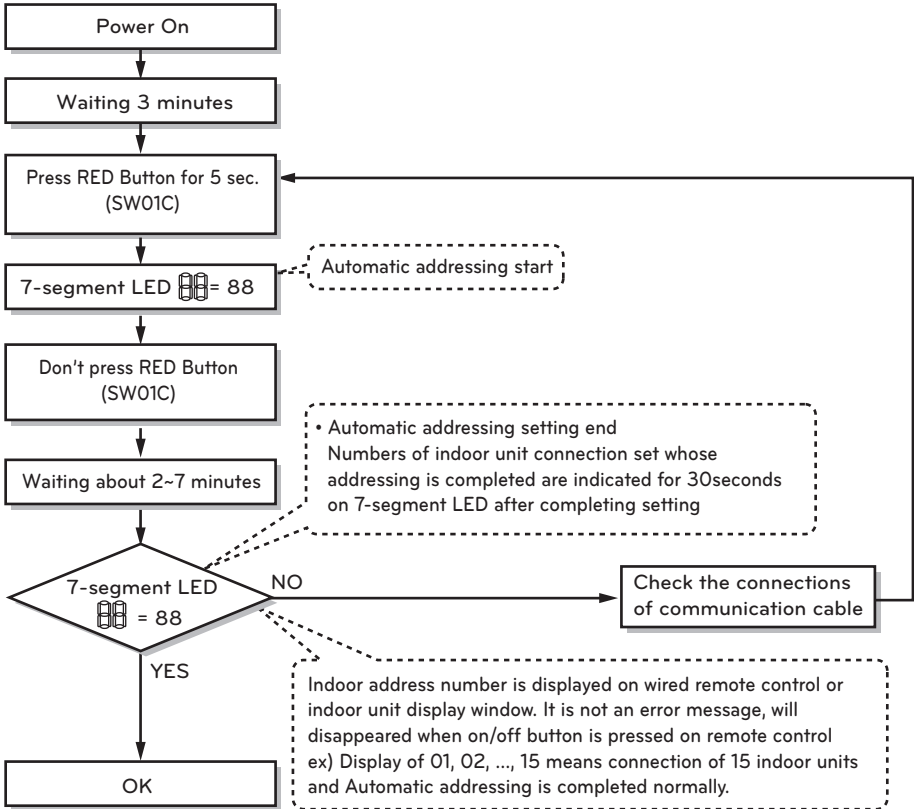

Setting the function

Select the mode/function/option/value using '▶', '◀' Button and confirm that using the '●' button after dip switch No.5 is turned on.

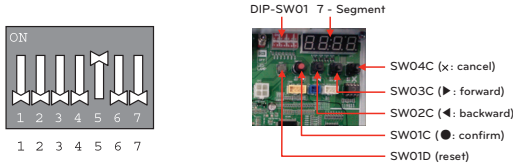

MODE		FUNCTION		OPTION		VALUE		ACTION		remarks	
content	Display1	content	Display2	content	Display3	content	Display4	implement	Display5		
Installation	Func	Cool & Heat Selector	F _n 1	oFF	op1~op2	selected the option	-	-	change the set value	blank	save in EEPROM
		Static pressure compensation	F _n 2	oFF	op1~op3	selected the option	-	-	change the set value	blank	save in EEPROM
		Night low noise	F _n 3	oFF	op1~op15	selected the option	-	-	change the set value	blank	save in EEPROM
		Overall defrost	F _n 4	on	oFF	selected the option	-	-	Always Overall defrost on	blank	save in EEPROM
		ODU address	F _n 5	-	-	0~254	set the value	change the set value	blank	save in EEPROM	
		Snow removal & rapid defrost	F _n 6	oFF	op1~op3	selected the option	-	-	change the set value	blank	save in EEPROM
		Target pressure auto adjusting	F _n 8	oFF	op1~op6	selected the option	-	-	change the set value	blank	save in EEPROM
		High Efficiency Cooling	F _n 9	oFF	on	selected the option	-	-	change the set value	blank	save in EEPROM
		Auto dust removal	F _n 10	oFF	on	selected the option	-	-	change the set value	blank	save in EEPROM
		Low ambient kit	F _n 11	oFF	on	selected the option	-	-	change the set value	blank	save in EEPROM
		Compressor Frequency Limitation	F _n 12	oFF	op1~op9	selected the option	-	-	change the set value	blank	save in EEPROM
		ODU fan Limitation	F _n 13	oFF	op1~op7	selected the option	-	-	change the set value	blank	save in EEPROM
		Smart Load Control	F _n 14	oFF	op1~op3	selected the option	-	-	change the set value	blank	save in EEPROM
SVC	id	Continuous cooling	id 6	oFF	op1~op3	-	-	change the set value	blank	-	

* Functions save in EEPROM will be kept continuously, though the system power was reset.

Cool & Heat selector

Mode setting method

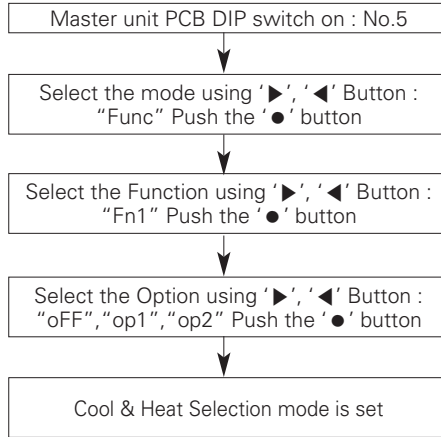

Function setting

Switch Control		Function		
Switch(Up)	Switch(Down)	oFF	op1(mode)	op2(mode)
Right side (On)	Left side (On)	Not operate	Cooling	Cooling
Right side (On)	Right side (On)	Not operate	Heating	Heating
Left side (Off)	-	Not operate	Fan mode	Off

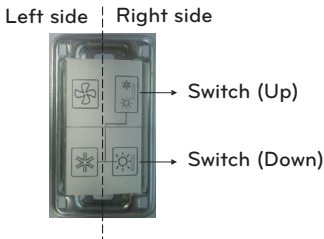

CAUTION

- Ask an authorized technician to setting a function.
- If do not use a function, set an off-mode.
- If use a function, first install a Cool & Heat selector.

Static pressure compensation mode

This function secures the air flow rate of ODU, in case static pressure has been applied like using duct at fan discharge of ODU.

Static pressure compensation mode setting method

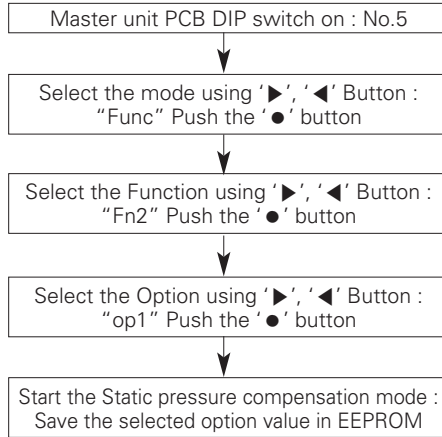

FAN Maximum RPM of each step

Capacity		8~14 HP	16~22 HP
Max. RPM	Standard	730	950
	op1	800	1000
	op2	820	-
	op3	850	-

Night Low Noise Function

In cooling mode, this function makes the ODU fan operate at low RPM to reduce the fan noise of ODU at night which has low cooling load.

Night low noise function setting method

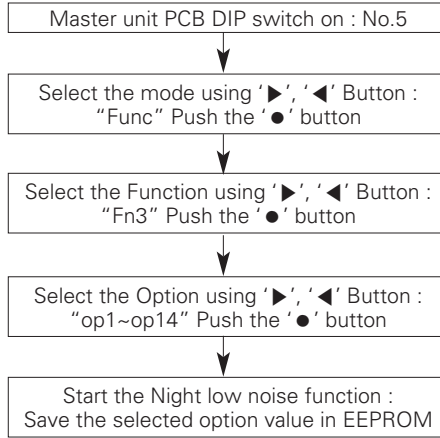

RPM/ Time Settings

Step	Judgment Time (Hr)	Operation Time(Hr)
op1	8	9
op2	6.5	10.5
op3	5	12
op4	8	9
op5	6.5	10.5
op6	5	12
op7	8	9
op8	6.5	10
op9	5	12
op10	0	Continuous operation
op11	0	
op12	0	
op13	6.5	10.5
op14	6.5	10.5

Noise

Heat Pump	Capacity	
	UX5	UX6
Step	Noise(dB)	
op1~op3, op10	55	59
op4~op6, op11	52	56
op7~op9, op12	49	53
op13	55	55
op14	50	50

* Reducing noise by changing ODU RPM, cooling capacity may go down. Please refer to the following table.

Reference of Cooling Capacity Table

Step	HP							
	8	10	12	14	16	18	20	22
op13	100	98	87	67	60	54	48	44
op14	98	78	69	55	49	44	39	35

CAUTION

- Request installer to set the function during installation.
- If setting the op 13,14 the cooling capacity may go down. When high load occurs at indoor, do not use this function.

Overall defrost mode

Mode setting method

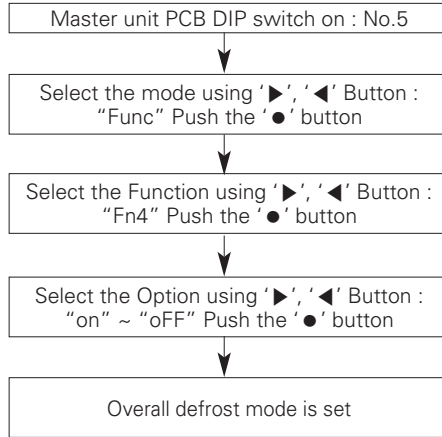

mode setting

- on: Operate overall defrost
- oFF: Operate partial defrost



CAUTION

- Ask an authorized technician to setting a function.
- * A(C)RUN***LLS4, A(C)RUN***LLN4 models operate only overall defrost function.

Setting the ODU address

Mode setting method

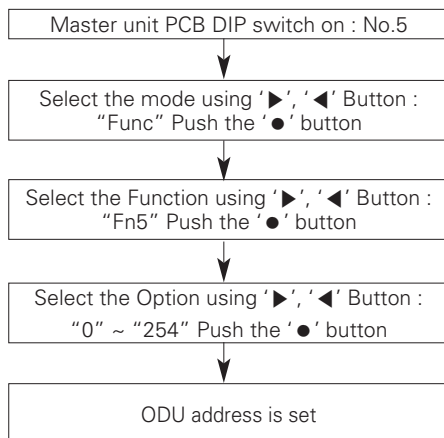

⚠ CAUTION

- Ask an authorized technician to setting a function.
- If use a function, first install a Central controller.

Snow removal & rapid defrost

Mode setting method

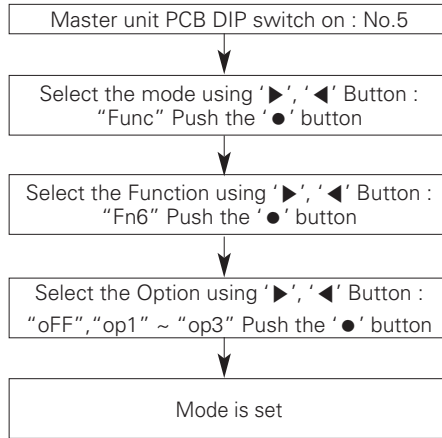

mode setting

setting	Mode
oFF	Not setting
op1	Snow removal mode
op2	Rapid defrost mode
op3	Snow removal mode. + Rapid defrost mode.

! CAUTION

- Ask an authorized technician to setting a function.
- If do not use a function, set an oFF-mode.

Target pressure adjusting

Mode setting method

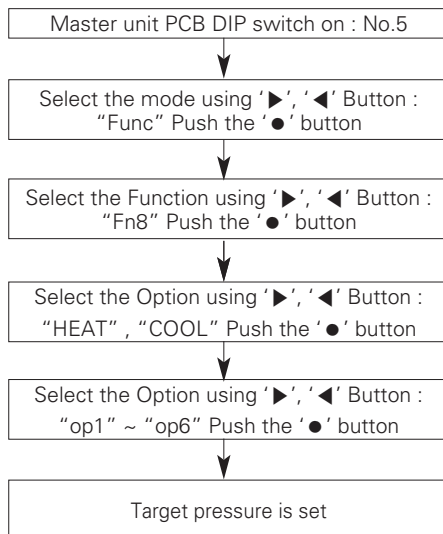

Setting

mode	Purpose		Condensing temperature variation	Evaporating temperature variation
	"Heat"	"Cool"		
oFF	Not setting			
op1	Increase capacity	Increase capacity	+2 °C	-3 °C
op2	Decrease power consumption	Increase capacity	-2.5 °C	-1.5 °C
op3	Decrease power consumption	Decrease power consumption	-4.5 °C	+2.5 °C
op4	Decrease power consumption	Decrease power consumption	-6.5 °C	+4.5 °C
op5	Decrease power consumption	Decrease power consumption	-8.5 °C	+6.5 °C
op6	Decrease power consumption	Decrease power consumption	-10.5 °C	+8.5 °C

! CAUTION

- Ask an authorized technician to setting a function.
- If do not use a function, set an off-mode.
- Change a power consumption or capacity.

High Efficiency cooling mode

According to the change of outdoor temperature, switch the target pressure for the high energy efficiency.

Mode setting method

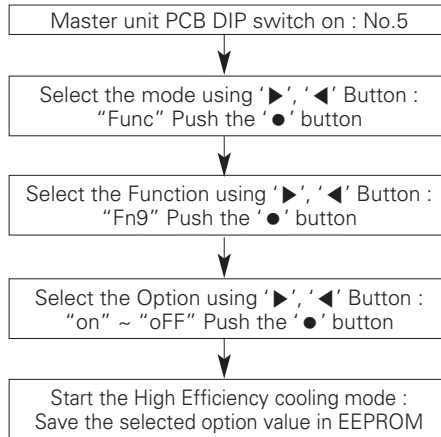

CAUTION

- Ask an authorized technician to setting a function.
- If use a function, first install a Central controller.

Auto dust removal mode

Reversing rotation of the fan motor, it's possible to remove dust automatically.

Mode setting method

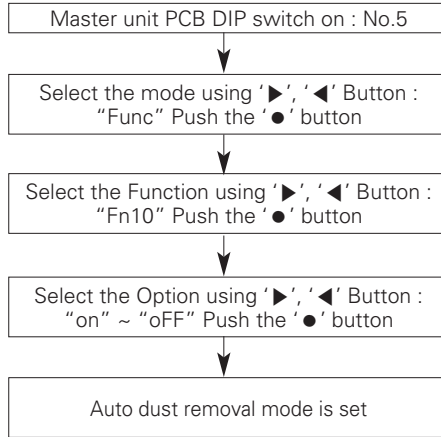

CAUTION

- Ask an authorized technician to setting a function.
- If use a function, first install a Central controller.

Smart Load Control

According to the difference of indoor temperature and setting temperature, switch the target pressure to increase efficiency.

Mode setting method

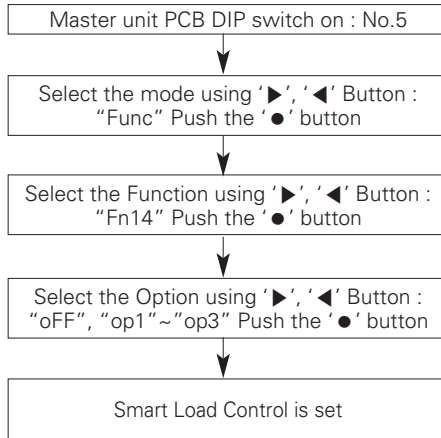

Mode Setting

Option	Setting
Off	Off
op1	Smooth Mode
op2	Quick Mode
op3	Power Mode



CAUTION

- Ask an authorized technician to setting a function.
- If use a function, first install a Central controller.

Continuous Cooling Function

In the cooling mode, this optional function enables the IDU to operate continuously with out thermo off to reduce ODU power consumption.

Continuous cooling function setting method

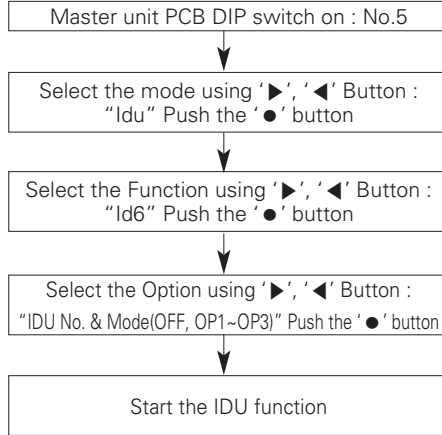

Mode Setting

Option	Setting
Off	Usual Operation
op1	Little low cooling, but least power consumption
op2	Medium Cooling with medium power consumption
op3	High cooling, but more power consumption

! CAUTION

- Ask an authorized technician to setting a function.
- If use a function, first install a Central controller.

Self-Diagnosis Function

Error Indicator

- This function indicates types of failure in self-diagnosis and occurrence of failure for air condition.
- Error mark is displayed on display window of indoor units and wired remote controller, and 7-segment LED of outdoor unit control board as shown in the table.
- If more than two troubles occur simultaneously, lower number of error code is first displayed.
- After error occurrence, if error is released, error LED is also released simultaneously.

Error Display

1st,2nd,3rd LED of 7-segment indicates error number, 4th LED indicates unit number.

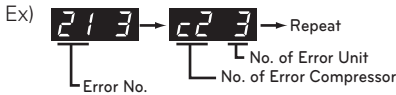

		Display	Title	Cause of Error
Indoor unit related error		0 1 -	Air temperature sensor of indoor unit	Air temperature sensor of indoor unit is open or short
		0 2 -	Inlet pipe temperature sensor of indoor unit	Inlet pipe temperature sensor of indoor unit is open or short
		0 3 -	Communication error : wired remote controller ↔ indoor unit	Failing to receive wired remote controller signal in indoor unit PCB
		0 4 -	Drain pump	Malfunction of drain pump
		0 5 -	Communication error : outdoor unit ↔ indoor unit	Failing to receive outdoor unit signal in indoor unit PCB
		0 6 -	Outlet pipe temperature sensor of indoor unit	Outlet pipe temperature sensor of indoor unit is open or short
		0 9 -	Indoor EEPROM Error	In case when the serial number marked on EEPROM of Indoor unit is 0 or FFFFFFFF
		1 0 -	Poor fan motor operation	Disconnecting the fan motor connector/Failure of indoor fan motor lock
Outdoor unit related error	2 1	1	Master Outdoor Unit Inverter Compressor IPM Fault	Master Outdoor Unit Inverter Compressor Drive IPM Fault
		2	Slave1 Outdoor Unit Inverter Compressor IPM Fault	Slave1 Outdoor Unit Inverter Compressor Drive IPM Fault
		3	Slave2 Outdoor Unit Inverter Compressor IPM Fault	Slave2 Outdoor Unit Inverter Compressor Drive IPM Fault
		4	Slave3 Outdoor Unit Inverter Compressor IPM Fault	Slave3 Outdoor Unit Inverter Compressor Drive IPM Fault
	2 2	1	Inverter Board Input Over Current(RMS) of Master Outdoor Unit	Master Outdoor Unit Inverter Board Input Current excess (RMS)
		2	Inverter Board Input Over Current(RMS) of Slave1 Outdoor Unit	Slave1 Outdoor Unit Inverter Board Input Current excess (RMS)
		3	Inverter Board Input Over Current(RMS) of Slave2 Outdoor Unit	Slave2 Outdoor Unit Inverter Board Input Current excess (RMS)
		4	Inverter Board Input Over Current(RMS) of Slave3 Outdoor Unit	Slave3 Outdoor Unit Inverter Board Input Current excess (RMS)

* Refer to the Indoor manual for some Indoor Error code.

Display			Title	Cause of Error
Outdoor unit related error	2	3	1 Master Outdoor Unit Inverter Compressor DC link Low Voltage	DC charging is not performed at Master Outdoor Unit after starting relay turn on.
			2 Slave1 Outdoor Unit Inverter Compressor DC link Low Voltage	DC charging is not performed at Slave1 Outdoor Unit after starting relay turn on.
			3 Slave2 Outdoor Unit Inverter Compressor DC link Low Voltage	DC charging is not performed at Slave2 Outdoor Unit after starting relay turn on.
			4 Slave3 Outdoor Unit Inverter Compressor DC link Low Voltage	DC charging is not performed at Slave3 Outdoor Unit after starting relay turn on.
	2	4	1 Master Outdoor Unit High Pressure Switch	System is turned off by Master Outdoor Unit high pressure switch.
			2 Slave1 Outdoor Unit High Pressure Switch	System is turned off by slave1 Outdoor Unit high pressure switch.
			3 Slave2 Outdoor Unit High Pressure Switch	System is turned off by slave2 Outdoor Unit high pressure switch.
			4 Slave3 Outdoor Unit High Pressure Switch	System is turned off by slave3 Outdoor Unit high pressure switch.
	2	5	1 Master Outdoor Unit Input Voltage High/ Low Voltage	Master Outdoor Unit input voltage is over 487V or below 270V
			2 Slave1 Outdoor Unit Input Voltage High/ Low Voltage	Slave1 Outdoor Unit input voltage is over 487V or below 270V
			3 Slave2 Outdoor Unit Input Voltage High/ Low Voltage	Slave2 Outdoor Unit input voltage is over 487V or below 270V
			4 Slave3 Outdoor Unit Input Voltage High/ Low Voltage	Slave3 Outdoor Unit input voltage is over 487V or below 270V
	2	6	1 Master Outdoor Unit Inverter Compressor Start Failure	The First Start Failure by Master Outdoor Unit Inverter Compressor Abnormality
			2 Slave1 Outdoor Unit Inverter Compressor Start Failure	The First Start Failure by Slave1 Outdoor Unit Inverter Compressor Abnormality
			3 Slave2 Outdoor Unit Inverter Compressor Start Failure	The First Start Failure by Slave2 Outdoor Unit Inverter Compressor Abnormality
			4 Slave3 Outdoor Unit Inverter Compressor Start Failure	The First Start Failure by Slave3 Outdoor Unit Inverter Compressor Abnormality
	2	9	1 Master Outdoor Unit Inverter Compressor Over Current	Master Outdoor Unit Inverter Compressor Fault OR Drive Fault
			2 Slave1 Outdoor Unit Inverter Compressor Over Current	Slave1 Outdoor Unit Inverter Compressor Fault OR Drive Fault
			3 Slave2 Outdoor Unit Inverter Compressor Over Current	Slave2 Outdoor Unit Inverter Compressor Fault OR Drive Fault
			4 Slave3 Outdoor Unit Inverter Compressor Over Current	Slave3 Outdoor Unit Inverter Compressor Fault OR Drive Fault

Display			Title	Cause of Error
Outdoor unit related error	3	2	1 Master Outdoor Unit Inverter Compressor1 High Discharge Temperature	Master Outdoor Unit Inverter Compressor1 High Discharge Temperature
			2 Slave1 Outdoor Unit Inverter Compressor1 High Discharge Temperature	Slave1 Outdoor Unit Inverter Compressor1 High Discharge Temperature
			3 Slave2 Outdoor Unit Inverter Compressor1 High Discharge Temperature	Slave2 Outdoor Unit Inverter Compressor1 High Discharge Temperature
			4 Slave3 Outdoor Unit Inverter Compressor1 High Discharge Temperature	Slave3 Outdoor Unit Inverter Compressor1 High Discharge Temperature
	3	3	1 Master Outdoor Unit Inverter Compressor2 High Discharge Temperature	Master Outdoor Unit Inverter Compressor2 High Discharge Temperature
			2 Slave1 Outdoor Unit Inverter Compressor2 High Discharge Temperature	Slave1 Outdoor Unit Inverter Compressor2 High Discharge Temperature
			3 Slave2 Outdoor Unit Inverter Compressor2 High Discharge Temperature	Slave2 Outdoor Unit Inverter Compressor2 High Discharge Temperature
			4 Slave3 Outdoor Unit Inverter Compressor2 High Discharge Temperature	Slave3 Outdoor Unit Inverter Compressor2 High Discharge Temperature
	3	4	1 High Pressure of Master Outdoor Unit	High Pressure of Master Outdoor Unit
			2 High Pressure of Slave1 Outdoor Unit	High Pressure of Slave1 Outdoor Unit
			3 High Pressure of Slave2 Outdoor Unit	High Pressure of Slave2 Outdoor Unit
			4 High Pressure of Slave3 Outdoor Unit	High Pressure of Slave3 Outdoor Unit
	3	5	1 Low Pressure of Master Outdoor Unit	Low Pressure of Master Outdoor Unit
			2 Low Pressure of Slave1 Outdoor Unit	Low Pressure of Slave1 Outdoor Unit
			3 Low Pressure of Slave2 Outdoor Unit	Low Pressure of Slave2 Outdoor Unit
			4 Low Pressure of Slave3 Outdoor Unit	Low Pressure of Slave3 Outdoor Unit
	3	6	1 Master Outdoor Unit Low Compression Ratio Limited	Master Outdoor Unit Low Compression Ratio Limited
			2 Slave1 Outdoor Unit Low Compression Ratio Limited	Slave1 Outdoor Unit Low Compression Ratio Limited
			3 Slave2 Outdoor Unit Low Compression Ratio Limited	Slave2 Outdoor Unit Low Compression Ratio Limited
			4 Slave3 Outdoor Unit Low Compression Ratio Limited	Slave3 Outdoor Unit Low Compression Ratio Limited

Display		Title	Cause of Error	
Outdoor unit related error	4 0	1	Master Outdoor Unit Inverter Compressor CT Sensor Fault	Master Outdoor Unit Inverter Compressor CT Sensor open or short
		2	Slave1 Outdoor Unit Inverter Compressor CT Sensor Fault	Slave1 Outdoor Unit Inverter Compressor CT Sensor open or short
		3	Slave2 Outdoor Unit Inverter Compressor CT Sensor Fault	Slave2 Outdoor Unit Inverter Compressor CT Sensor open or short
		4	Slave3 Outdoor Unit Inverter Compressor CT Sensor Fault	Slave3 Outdoor Unit Inverter Compressor CT Sensor open or short
	4 1	1	Master Outdoor Unit Inverter Compressor1 Discharge Temperature Sensor Fault	Master Outdoor Unit Inverter Compressor Discharge Temperature Sensor open or short
		2	Slave1 Outdoor Unit Inverter Compressor1 Discharge Temperature Sensor Fault	Slave1 Outdoor Unit Inverter Compressor Discharge Temperature Sensor open or short
		3	Slave2 Outdoor Unit Inverter Compressor1 Discharge Temperature Sensor Fault	Slave2 Outdoor Unit Inverter Compressor Discharge Temperature Sensor open or short
		4	Slave3 Outdoor Unit Inverter Compressor1 Discharge Temperature Sensor Fault	Slave3 Outdoor Unit Inverter Compressor Discharge Temperature Sensor open or short
	4 2	1	Master Outdoor Unit Low Pressure Sensor Fault	Master Outdoor Unit Low Pressure Sensor open or short
		2	Slave1 Outdoor Unit Low Pressure Sensor Fault	Slave1 Outdoor Unit Low Pressure Sensor open or short
		3	Slave2 Outdoor Unit Low Pressure Sensor Fault	Slave2 Outdoor Unit Low Pressure Sensor open or short
		4	Slave3 Outdoor Unit Low Pressure Sensor Fault	Slave3 Outdoor Unit Low Pressure Sensor open or short
	4 3	1	Master Outdoor Unit High Pressure Sensor Fault	Master Outdoor Unit High Pressure Sensor open or short
		2	Slave1 Outdoor Unit High Pressure Sensor Fault	Slave1 Outdoor Unit High Pressure Sensor open or short
		3	Slave2 Outdoor Unit High Pressure Sensor Fault	Slave2 Outdoor Unit High Pressure Sensor open or short
		4	Slave3 Outdoor Unit High Pressure Sensor Fault	Slave3 Outdoor Unit High Pressure Sensor open or short
	4 4	1	Master Outdoor Unit Air Temperature Sensor Fault	Master Outdoor Unit Air Temperature Sensor open or short
		2	Slave1 Outdoor Unit Air Temperature Sensor Fault	Slave1 Outdoor Unit Air Temperature Sensor open or short
		3	Slave2 Outdoor Unit Air Temperature Sensor Fault	Slave2 Outdoor Unit Air Temperature Sensor open or short
		4	Slave3 Outdoor Unit Air Temperature Sensor Fault	Slave3 Outdoor Unit Air Temperature Sensor open or short

Display			Title	Cause of Error	
Outdoor unit related error	4	5	1	Master Outdoor Unit Heat Exchanger Temperature Sensor (Front side) Fault	Master Outdoor Unit Heat Exchanger Temperature Sensor(Front side) open or short
			2	Slave1 Outdoor Unit Heat Exchanger Temperature Sensor (Front side) Fault	Slave1 Outdoor Unit Heat Exchanger Temperature Sensor (Front side) open or short
			3	Slave2 Outdoor Unit Heat Exchanger Temperature Sensor (Front side) Fault	Slave2 Outdoor Unit Heat Exchanger Temperature Sensor(Front side) open or short
			4	Slave3 Outdoor Unit Heat Exchanger Temperature Sensor (Front side) Fault	Slave3 Outdoor Unit Heat Exchanger Temperature Sensor(Front side) open or short
	4	6	1	Master Outdoor Unit Suction Temperature Sensor Fault	Master Outdoor Unit Suction Temperature Sensor open or short
			2	Slave1 Outdoor Unit Suction Temperature Sensor Fault	Slave1 Outdoor Unit Suction Temperature Sensor open or short
			3	Slave2 Outdoor Unit Suction Temperature Sensor Fault	Slave2 Outdoor Unit Suction Temperature Sensor open or short
			4	Slave3 Outdoor Unit Suction Temperature Sensor Fault	Slave3 Outdoor Unit Suction Temperature Sensor open or short
	4	7	1	Master Outdoor Unit Inverter Compressor2 Discharge Temperature Sensor Fault	Master Outdoor Unit Inverter Compressor2 Discharge Temperature Sensor open or short
			2	Slave1 Outdoor Unit Inverter Compressor2 Discharge Temperature Sensor Fault	Slave1 Outdoor Unit Inverter Compressor2 Discharge Temperature Sensor open or short
			3	Slave2 Outdoor Unit Inverter Compressor2 Discharge Temperature Sensor Fault	Slave2 Outdoor Unit Inverter Compressor2 Discharge Temperature Sensor open or short
			4	Slave3 Outdoor Unit Inverter Compressor2 Discharge Temperature Sensor Fault	Slave3 Outdoor Unit Inverter Compressor2 Discharge Temperature Sensor open or short
	5	0	1	Omitting connection of R, S, T power of Master Outdoor Unit	Omitting connection of Master outdoor unit
			2	Omitting connection of R, S, T power of Slave1 Outdoor Unit	Omitting connection of Slave1 Outdoor Unit
			3	Omitting connection of R, S, T power of Slave2 Outdoor Unit	Omitting connection of Slave2 Outdoor Unit
			4	Omitting connection of R, S, T power of Slave3 Outdoor Unit	Omitting connection of Slave3 Outdoor Unit

Display			Title	Cause of Error
Outdoor unit related error	5	1	1 Excessive capacity of indoor units	Excessive connection of indoor units compared to capacity of Outdoor Unit
	5	2	1 Communication error : inverter PCB → Main PCB	Failing to receive inverter signal at main PCB of Master Outdoor Unit
			2 Communication error : inverter PCB → Main PCB	Failing to receive inverter signal at main PCB of Slave1 Outdoor Unit
			3 Communication error : inverter PCB → Main PCB	Failing to receive inverter signal at main PCB of Slave2 Outdoor Unit
			4 Communication error : inverter PCB → Main PCB	Failing to receive inverter signal at main PCB of Slave3 Outdoor Unit
	5	3	1 Communication error : indoor unit → Main PCB of Outdoor Unit	Failing to receive indoor unit signal at main PCB of Outdoor Unit .
	5	7	1 Communication error : Main PCB → inverter PCB	Failing to receive signal main PCB at inverter PCB of Master Outdoor Unit
			2 Communication error : Main PCB → inverter PCB	Failing to receive signal main PCB at inverter PCB of Slave1 Outdoor Unit
			3 Communication error : Main PCB → inverter PCB	Failing to receive signal main PCB at inverter PCB of Slave2 Outdoor Unit
			4 Communication error : Main PCB → inverter PCB	Failing to receive signal main PCB at inverter PCB of Slave3 Outdoor Unit
	5	9	1 Mixing Installation of Sub Outdoor Unit	Mixing Installation of Old Sub Outdoor Unit and New Slave Outdoor Unit
	6	0	1 Inverter PCB EEPROM Error of Master Outdoor Unit	Access Error of Inverter PCB of Master Outdoor Unit
			2 Inverter PCB EEPROM Error of Slave1 Unit	Access Error of Inverter PCB of Slave1 Outdoor Unit
			3 Inverter PCB EEPROM Error of Slave2 Unit	Access Error of Inverter PCB of Slave2 Outdoor Unit
			4 Inverter PCB EEPROM Error of Slave3 Unit	Access Error of Inverter PCB of Slave3 Outdoor Unit
	6	2	1 Master Outdoor Unit Inverter Heatsink High Temperature	System is turned off by Master Outdoor Unit Inverter Heatsink High Temperature
			2 Slave1 Outdoor Unit Inverter Heatsink High Temperature	System is turned off by Slave1 Outdoor Unit Inverter Heatsink High Temperature
			3 Slave2 Outdoor Unit Inverter Heatsink High Temperature	System is turned off by Slave2 Outdoor Unit Inverter Heatsink High Temperature
			4 Slave3 Outdoor Unit Inverter Heatsink High Temperature	System is turned off by Slave3 Outdoor Unit Inverter Heatsink High Temperature

Display			Title	Cause of Error
Outdoor unit related error	6	5	1 Master Outdoor Unit Inverter Heatsink Temperature Sensor Fault	Master Outdoor Unit Inverter Heatsink Temperature Sensor open or short
			2 Slave1 Outdoor Unit Inverter Heatsink Temperature Sensor Fault	Slave1 Outdoor Unit Inverter Heatsink Temperature Sensor open or short
			3 Slave2 Outdoor Unit Inverter Heatsink Temperature Sensor Fault	Slave2 Outdoor Unit Inverter Heatsink Temperature Sensor open or short
			4 Slave3 Outdoor Unit Inverter Heatsink Temperature Sensor Fault	Slave3 Outdoor Unit Inverter Heatsink Temperature Sensor open or short
	6	7	1 Master Outdoor Unit Fan Lock	Restriction of Master Outdoor Unit
			2 Slave1 Outdoor Unit Fan Lock	Restriction of Slave1 Outdoor Unit
			3 Slave2 Outdoor Unit Fan Lock	Restriction of Slave2 Outdoor Unit
			4 Slave3 Outdoor Unit Fan Lock	Restriction of Slave3 Outdoor Unit
	7	1	1 Converter CT Sensor Error of Master Outdoor Unit	Converter CT Sensor open or short of Master Outdoor Unit
			2 Converter CT Sensor Error of Slave1 Outdoor Unit	Converter CT Sensor open or short of Slave1 Outdoor Unit
			3 Converter CT Sensor Error of Slave2 Outdoor Unit	Converter CT Sensor open or short of Slave2 Outdoor Unit
			4 Converter CT Sensor Error of Slave3 Outdoor Unit	Converter CT Sensor open or short of Slave3 Outdoor Unit
	7	5	1 Master Outdoor Unit Fan CT Sensor Error	Master Outdoor Unit Fan CT Sensor open or short
			2 Slave1 Outdoor Unit Fan CT Sensor Error	Slave1 Outdoor Unit Fan CT Sensor open or short
			3 Slave2 Outdoor Unit Fan CT Sensor Error	Slave2 Outdoor Unit Fan CT Sensor open or short
			4 Slave3 Outdoor Unit Fan CT Sensor Error	Slave3 Outdoor Unit Fan CT Sensor open or short
	7	6	1 Master Outdoor Unit Fan DC Link High Voltage Error	Master Outdoor Unit Fan DC Link High Voltage Error
			2 Slave1 Outdoor Unit Fan DC Link High Voltage Error	Slave1 Outdoor Unit Fan DC Link High Voltage Error
			3 Slave2 Outdoor Unit Fan DC Link High Voltage Error	Slave2 Outdoor Unit Fan DC Link High Voltage Error
			4 Slave3 Outdoor Unit Fan DC Link High Voltage Error	Slave3 Outdoor Unit Fan DC Link High Voltage Error

Display			Title	Cause of Error
Outdoor unit related error	7	7	1 Master Outdoor Unit Fan Over Current Error	Master Outdoor Unit Fan Current is over 5A
			2 Slave1 Outdoor Unit Fan Over Current Error	Slave1 Outdoor Unit Fan Current is over 5A
			3 Slave2 Outdoor Unit Fan Over Current Error	Slave2 Outdoor Unit Fan Current is over 5A
			4 Slave3 Outdoor Unit Fan Over Current Error	Slave3 Outdoor Unit Fan Current is over 5A
	7	9	1 Master Outdoor Unit Fan Start Failure Error	Master Outdoor Unit Fan First Position Sensing Failure
			2 Slave1 Outdoor Unit Fan Start Failure Error	Slave1 Outdoor Unit Fan First Position Sensing Failure
			3 Slave2 Outdoor Unit Fan Start Failure Error	Slave2 Outdoor Unit Fan First Position Sensing Failure
			4 Slave3 Outdoor Unit Fan Start Failure Error	Slave3 Outdoor Unit Fan First Position Sensing Failure
	8	6	1 Master Outdoor Unit Main PCB EEPROM Error	Communication Fail Between Master Outdoor Unit Main MICOM and EEPROM or omitting EEPROM
			2 Slave1 Outdoor Unit Main PCB EEPROM Error	Communication Fail Between Slave1 Outdoor Unit Main MICOM and EEPROM or omitting EEPROM
			3 Slave2 Outdoor Unit Main PCB EEPROM Error	Communication Fail Between Slave2 Outdoor Unit Main MICOM and EEPROM or omitting EEPROM
			4 Slave3 Outdoor Unit Main PCB EEPROM Error	Communication Fail Between Slave3 Outdoor Unit Main MICOM and EEPROM or omitting EEPROM
	8	7	1 Master Outdoor Unit Fan PCB EEPROM Error	Communication Fail Between Master Outdoor Unit Fan MICOM and EEPROM or omitting EEPROM
			2 Slave1 Outdoor Unit Fan PCB EEPROM Error	Communication Fail Between Slave1 Outdoor Unit Fan MICOM and EEPROM or omitting EEPROM
			3 Slave2 Outdoor Unit Fan PCB EEPROM Error	Communication Fail Between Slave2 Outdoor Unit Fan MICOM and EEPROM or omitting EEPROM
			4 Slave3 Outdoor Unit Fan PCB EEPROM Error	Communication Fail Between Slave3 Outdoor Unit Fan MICOM and EEPROM or omitting EEPROM

Display				Title	Cause of Error	
Outdoor unit related error	1	0	4	1	Communication Error Between Master Outdoor Unit and Other Outdoor Unit	Failing to receive Slave Unit signal at main PCB of Master Outdoor Unit
				2	Communication Error Between Slave1 Outdoor Unit and Other Outdoor Unit	Failing to receive Master and other Slave Unit signal at main PCB of Slave1 Outdoor Unit
				3	Communication Error Between Slave2 Outdoor Unit and Other Outdoor Unit	Failing to receive Master and other Slave Unit signal at main PCB of Slave2 Outdoor Unit
				4	Communication Error Between Slave3 Outdoor Unit and Other Outdoor Unit	Failing to receive Master and other Slave Unit signal at main PCB of Slave3 Outdoor Unit
	1	0	5	1	Master Outdoor Unit Fan PCB Communication Error	Failing to receive fan signal at main PCB of Master unit.
				2	Slave1 Outdoor Unit Fan PCB Communication Error	Failing to receive fan signal at main PCB of Slave1 unit.
				3	Slave2 Outdoor Unit Fan PCB Communication Error	Failing to receive fan signal at main PCB of Slave2 unit.
				4	Slave3 Outdoor Unit Fan PCB Communication Error	Failing to receive fan signal at main PCB of Slave3 unit.
	1	0	6	1	Master Outdoor Unit FAN IPM Fault Error	Instant Over Current at Master Outdoor Unit Fan IPM
				2	Slave1 Outdoor Unit FAN IPM Fault Error	Instant Over Current at Slave1 Outdoor Unit Fan IPM
				3	Slave2 Outdoor Unit FAN IPM Fault Error	Instant Over Current at Slave2 Outdoor Unit Fan IPM
				4	Slave3 Outdoor Unit FAN IPM Fault Error	Instant Over Current at Slave3 Outdoor Unit Fan IPM
	1	0	7	1	Master Outdoor Unit Fan DC Link Low Voltage Error	Master Outdoor Unit Fan DC Link Input Voltage is under 380V
				2	Slave1 Outdoor Unit Fan DC Link Low Voltage Error	Slave1 Outdoor Unit Fan DC Link Input Voltage is under 380V
				3	Slave2 Outdoor Unit Fan DC Link Low Voltage Error	Slave2 Outdoor Unit Fan DC Link Input Voltage is under 380V
				4	Slave3 Outdoor Unit Fan DC Link Low Voltage Error	Slave3 Outdoor Unit Fan DC Link Input Voltage is under 380V
1	1	3	1	Master Outdoor Unit Liquid pipe Temperature Sensor Error	Liquid pipe temperature sensor of Master Outdoor Unit is open or short	
			2	Slave1 Outdoor Unit Liquid pipe Temperature Sensor Error	Liquid pipe temperature sensor of slave1 Outdoor Unit is open or short	
			3	Slave2 Outdoor Unit Liquid pipe Temperature Sensor Error	Liquid pipe temperature sensor of slave2 Outdoor Unit is open or short	
			4	Slave3 Outdoor Unit Liquid pipe Temperature Sensor Error	Liquid pipe temperature sensor of slave3 Outdoor Unit is open or short	

Display				Title	Cause of Error	
Outdoor unit related error	1	1	5	1	Master Outdoor Unit Subcooling Outlet Temperature Sensor Error	Master Outdoor Unit Subcooling Outlet Temperature Sensor Error
				2	Slave1 Outdoor Unit Subcooling Outlet Temperature Sensor Error	Slave1 Outdoor Unit Subcooling Outlet Temperature Sensor Error
				3	Slave2 Outdoor Unit Subcooling Outlet Temperature Sensor Error	Slave2 Outdoor Unit Subcooling Outlet Temperature Sensor Error
				4	Slave3 Outdoor Unit Subcooling Outlet Temperature Sensor Error	Slave3 Outdoor Unit Subcooling Outlet Temperature Sensor Error
	1	4	5	1	Master outdoor unit Main Board - External Board communication Error	Master outdoor unit Main Board - External Board communication Error
				2	Slave1 outdoor unit Main Board - External Board communication Error	Slave1 outdoor unit Main Board - External Board communication Error
				3	Slave2 outdoor unit Main Board - External Board communication Error	Slave2 outdoor unit Main Board - External Board communication Error
				4	Slave3 outdoor unit Main Board - External Board communication Error	Slave3 outdoor unit Main Board - External Board communication Error
	1	5	1	1	Failure of operation mode conversion at Master Outdoor Unit	Failure of operation mode conversion at Master Outdoor Unit
				2	Failure of operation mode conversion at Slave1 Outdoor Unit	Failure of operation mode conversion at Slave1 Outdoor Unit
				3	Failure of operation mode conversion at Slave2 Outdoor Unit	Failure of operation mode conversion at Slave2 Outdoor Unit
				4	Failure of operation mode conversion at Slave3 Outdoor Unit	Failure of operation mode conversion at Slave3 Outdoor Unit

Display				Title	Cause of Error	
Outdoor unit related error	1	8	2	1	Master outdoor unit External Board Main-Sub Micom communication Error	Master Outdoor Unit Main Board Main-Sub Micom communication failed
				2	Slave1 outdoor unit External Board Main-Sub Micom communication Error	Slave1 Outdoor Unit Main Board Main-Sub Micom communication failed
				3	Slave2 outdoor unit External Board Main-Sub Micom communication Error	Slave2 Outdoor Unit Main Board Main-Sub Micom communication failed
				4	Slave3 outdoor unit External Board Main-Sub Micom communication Error	Slave3 Outdoor Unit Main Board Main-Sub Micom communication failed
	1	9	3	1	Master Outdoor Unit Fan Heatsink High Temperature	System is turned off by Master Outdoor Unit Fan Heatsink High Temperature
				2	Slave1 Outdoor Unit Fan Heatsink High Temperature	System is turned off by Slave1 Outdoor Unit Fan Heatsink High Temperature
				3	Slave2 Outdoor Unit Fan Heatsink High Temperature	System is turned off by Slave2 Outdoor Unit Fan Heatsink High Temperature
				4	Slave3 Outdoor Unit Fan Heatsink High Temperature	System is turned off by Slave3 Outdoor Unit Fan Heatsink High Temperature
	1	9	4	1	Master Outdoor Unit Fan Heatsink Temperature Sensor Fault	Master Outdoor Unit Fan Heatsink Temperature Sensor open or short
				2	Slave1 Outdoor Unit Fan Heatsink Temperature Sensor Fault	Slave1 Outdoor Unit Fan Heatsink Temperature Sensor open or short
				3	Slave2 Outdoor Unit Fan Heatsink Temperature Sensor Fault	Slave2 Outdoor Unit Fan Heatsink Temperature Sensor open or short
				4	Slave3 Outdoor Unit Fan Heatsink Temperature Sensor Fault	Slave3 Outdoor Unit Fan Heatsink Temperature Sensor open or short

CAUTION FOR REFRIGERANT LEAK

The installer and system specialist shall secure safety against leakage according to local regulations or standards.
The following standards may be applicable if local regulations are not available.

Introduction

Though the R410A refrigerant is harmless and incombustible itself, the room to equip the air conditioner should be large to such an extent that the refrigerant gas will not exceed the limiting concentration even if the refrigerant gas leaks in the room.

Limiting concentration

Limiting concentration is the limit of Freon gas concentration where immediate measures can be taken without hurting human body when refrigerant leaks in the air. The limiting concentration shall be described in the unit of kg/m^3 (Freon gas weight per unit air volume) for facilitating calculation.

Limiting concentration: $0.44 \text{ kg/m}^3(\text{R410A})$

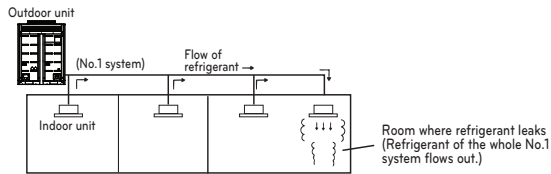

Checking procedure of limiting concentration

Check limiting concentration along following steps and take appropriate measure depending on the situation.

Calculate amount of all the replenished refrigerant (kg) per each refrigerant system.

$$\begin{array}{l} \text{Amount of replenished} \\ \text{refrigerant per one outdoor} \\ \text{unit system} \end{array} + \begin{array}{l} \text{Amount of additional} \\ \text{replenished refrigerant} \end{array} = \begin{array}{l} \text{Total amount of replenished} \\ \text{refrigerant in refrigerant} \\ \text{facility (kg)} \end{array}$$

Amount of replenished refrigerant at factory shipment

Amount of additionally replenished refrigerant depending on piping length or piping diameter at customer

Note : In case one refrigerant facility is divided into 2 or more refrigerant systems and each system is independent, amount of replenished refrigerant of each system shall be adopted.

Calculate minimum room capacity

Calculate room capacity by regarding a portion as one room or the smaller room.

- Without partition

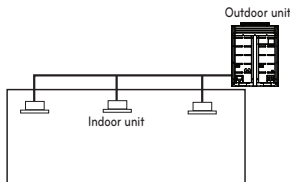

- With partition and with opening which serve as passage of air to adjoining room

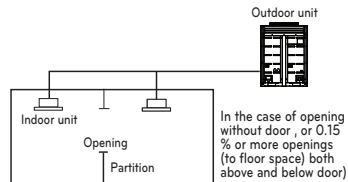

- With partition and without opening which serve as passage of air to adjoining room

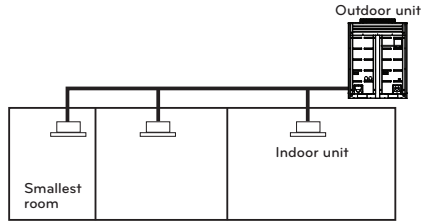

Calculate refrigerant concentration

$$\frac{\text{Total amount of replenished refrigerant in refrigerant facility (kg)}}{\text{Capacity of smallest room where indoor unit is installed (m}^3\text{)}} = \text{Refrigerant concentration (kg/m}^3\text{)} \quad \text{(R410A)}$$

In case the result of calculation exceeds the limiting concentration, perform the same calculations by shifting to the second smallest, and the third smallest rooms until at last the result is below the limiting concentration.

In case the concentration exceeds the limit

When the concentration exceeds the limit, change original plan or take one of the countermeasures shown below:

- Countermeasure 1
Provide opening for ventilation.
Provide 0.15 % or more opening to floor space both above and below door, or provide opening without door.
- Countermeasure 2
Provide gas leak alarm linked with mechanical ventilator.
Reducing the outdoor refrigerant qty.

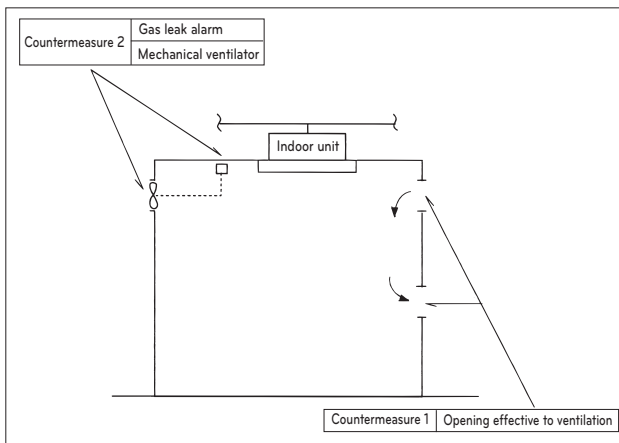

Pay a special attention to the place, such as a basement, etc. where refrigerant can stay, since refrigerant is heavier than air.

INSTALLATION GUIDE AT THE SEASIDE

! CAUTION

- Air conditioners should not be installed in areas where corrosive gases, such as acid or alkaline gas, are produced.
- Do not install the product where it could be exposed to sea wind (salty wind) directly. It can result corrosion on the product. Corrosion, particularly on the condenser and evaporator fins, could cause product malfunction or inefficient performance.
- If outdoor unit is installed close to the seaside, it should avoid direct exposure to the sea wind. Otherwise it needs additional anticorrosion treatment on the heat exchanger.

In case, to install the outdoor unit on the seaside, set up a windbreak not to be exposed to the sea wind.

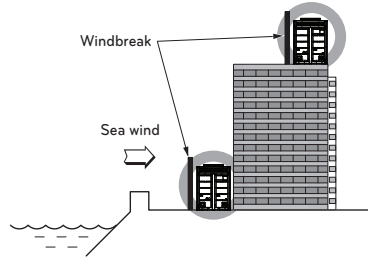

- It should be strong enough like concrete to prevent the sea wind from the sea.
- The height and width should be more than 150% of the outdoor unit.
- It should be keep more than 70 cm of space between outdoor unit and the windbreak for easy air flow.

Selecting the location(Outdoor Unit)

If the outdoor unit is to be installed close to the seaside, direct exposure to the sea wind should be avoided. Install the outdoor unit on the opposite side of the sea wind direction.

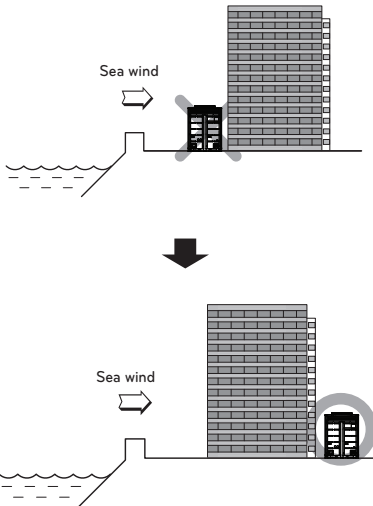

Select a well-drained place.

- Periodic (more than once/year) cleaning of the dust or salt particles stuck on the heat exchanger by using water

