



Scan the QR code to see the manual.



OWNER'S MANUAL

# AIR CONDITIONER

---



In order to use the product safely and conveniently, please read the owner's manual before using the product.

**ENGLISH**

TYPE: WALL MOUNTED



MFL72096442  
Rev.00\_071625

[www.lg.com](http://www.lg.com)

Copyright © 2017-2025 LG Electronics. All Rights Reserved

# TABLE OF CONTENTS

This manual may contain images or content that may be different from the model you purchased.  
This manual is subject to revision by the manufacturer.

## SAFETY INSTRUCTIONS

READ ALL INSTRUCTIONS BEFORE USE..... 3  
WARNING INSTRUCTIONS ..... 4  
CAUTION INSTRUCTIONS ..... 9

## OPERATION

Before Use ..... 11  
Product Overviews ..... 12  
Preparation before Operation..... 13  
Wireless Remote Control Overview ..... 15  
Using Operating Modes ..... 18  
Using Special Functions ..... 23

## SMART FUNCTIONS

LG ThinQ Application ..... 35  
Diagnosis Using LG ThinQ ..... 39

## MAINTENANCE

Cleaning ..... 41

## TROUBLESHOOTING

Before Calling for Service..... 52

# SAFETY INSTRUCTIONS

## READ ALL INSTRUCTIONS BEFORE USE

The following safety guidelines are intended to prevent unforeseen risks or damage from unsafe or incorrect operation of the appliance. The guidelines are separated into 'WARNING' and 'CAUTION' as described below.

### Safety Messages



This symbol is displayed to indicate matters and operations that can cause risk.

Read the part with this symbol carefully and follow the instructions in order to avoid risk.



### **WARNING**

This indicates that the failure to follow the instructions can cause serious injury or death.



### **CAUTION**

This indicates that the failure to follow the instructions can cause the minor injury or damage to the product.

### Notes for Flammable Refrigerant

The following symbols are displayed on units.



This symbol indicates that this appliance uses a flammable refrigerant. If the refrigerant is leaked and exposed to an external ignition source, there is a risk of fire.



This symbol indicates that the Owner's Manual should be read carefully.



This symbol indicates that service personnel should be handling this equipment with reference to the Installation Manual.



This symbol indicates that information is available in the Owner's Manual or Installation Manual.

## WARNING INSTRUCTIONS

---

### **WARNING**

- To reduce the risk of explosion, fire, death, electric shock, injury or scalding to persons when using this product, follow basic precautions, including the following:

### **Technical Safety**

- This appliance can be used by children aged from 8 years and above and persons with reduced physical, sensory or mental capabilities or lack of experience and knowledge if they have been given supervision or instruction concerning use of the appliance in a safe way and understand the hazards involved. Children shall not play with the appliance. Cleaning and user maintenance shall not be made by children without supervision.
- This appliance is not intended for use by persons (including children) with reduced physical, sensory or mental capabilities, or lack of experience and knowledge, unless they have been given supervision or instruction concerning use of the appliance by a person

responsible for their safety. Children should be supervised to ensure that they do not play with the appliance.

- Installation or repairs made by unauthorized persons can pose hazards to you and others.
- The information contained in the manual is intended for use by a qualified service technician who is familiar with the safety procedures and equipped with the proper tools and test instruments.
- Failure to read and follow all instructions in this manual can result in equipment malfunction, property damage, personal injury and/or death.
- The refrigerant and insulation blowing gas used in the appliance require special disposal procedures. Consult a service agent or a similarly qualified person before disposing of them.
- When the power cord is to be replaced, the replacement work shall be performed by authorized personnel using only genuine replacement parts.
- If the supply cord is damaged, it must be replaced by the manufacturer, its service agent or similarly qualified person in order to avoid a hazard.
- The appliance shall be installed in accordance with national wiring regulations.
- Means for disconnection must be incorporated in the fixed wiring in accordance with the wiring rules.
- This appliance must be properly grounded to minimize risk of electric shock.
- Do not cut or remove the grounding prong from the power plug.
- Attaching the earth wire to the power outlet cover screw does not ground the appliance unless the cover screw is metal, uninsulated, and the power outlet is grounded through house wiring.
- If you have any doubt whether the air conditioner is properly grounded, have the power outlet and circuit checked by a qualified electrician.

### Installation

- Contact an authorized service centre when installing or relocating the air conditioner.
- Do not install the air conditioner on an unstable surface or in a place where there is danger of it falling.
- Do not install the unit in potentially explosive atmospheres.
- Do not install the air conditioner in a place where flammable liquids or gases such as gasoline, propane, paint thinner, etc., are stored.
- Install the panel and the cover of the control box safely.
- Install a dedicated electric outlet and circuit breaker before using the air conditioner.
- Use standard circuit breaker and fuse that conform to the rating of the air conditioner.
- Make sure that the pipe and the power cable connecting the indoor and outdoor units are not pulled too tight when installing the air conditioner.
- The indoor/outdoor wiring connections must be secured tightly, and the cable should be routed properly so that there is no force pulling the cable from the connection terminals. Improper or loose connections can generate heat or cause a fire.
- Do not connect the ground wire to a gas pipe, a lightning rod, or a telephone ground wire.
- Use non-flammable gas (nitrogen) to check for leaks and to purge air; using compressed air or flammable gas may cause fire or explosion.

### Operation

- Do not modify or extend the power cable. Scratches or peeling insulation on the power cables may result in fire or electric shock, and should be replaced.
- Make sure that the power cable is neither dirty, loose, nor broken.
- Do not place any objects on the power cable.
- Do not place a heater or other heating appliances near the power cable.

- Take care to ensure that the power cable could not be pulled out or damaged during operation.
- Never touch, operate, or repair the air conditioner with wet hands.
- Do not insert hands or other objects through the air inlet or outlet while the air conditioner is operating.
- Make sure that children do not climb on or hit the outdoor unit.
- Be sure to use only those parts listed in the service parts list. Never attempt to modify the equipment.
- Do not touch the refrigerant pipe, water pipe or any internal parts while the unit is operating or immediately after operation.
- Do not leave flammable substances such as gasoline, benzene, or thinner near the air conditioner.
- Do not use the air conditioner for an extended period of time in a small place without proper ventilation.
- Be sure to ventilate sufficiently when the air conditioner and a heating appliance such as a heater are used simultaneously.
- Do not block the inlet or outlet of airflow.
- Cut off the power supply if there is any noise, smell, or smoke coming from the air conditioner.
- Contact an authorized service centre when the air conditioner is submerged by flood waters.
- In the event of a gas leak (such as Freon, propane gas, LP gas, etc.) ventilate sufficiently before using the air conditioner again.
- Cut off the power supply immediately in the event of a blackout or a thunderstorm.

## **Remote Control**

- Remove the batteries if the remote control is not to be used for an extended period of time.
- Never mix different types of batteries, or old and new batteries for the remote control.
- Do not recharge or disassemble the batteries.

- Stop using the remote control if there is a fluid leak in the battery. If your clothes or skin is exposed to the leaking battery fluid, wash off with clean water.
- If the leaking battery fluid has been swallowed, rinse the inside of the mouth thoroughly and consult a doctor.
- Dispose of the batteries in a place where there is no danger of fire.

### **Maintenance**

- Before cleaning or performing maintenance, disconnect the power supply and wait until the fan stops.
- Do not clean the appliance by spraying water directly onto the product.

### **Refrigerant**

#### General

- Use only the refrigerant specified on the air conditioner label.
- Do not use uncertified refrigerants.
- Do not input air or gas into the system except the specified refrigerant.
- Do not touch the leaking refrigerant during installation or repair.
- Be sure to check for refrigerant leaks after installing or repairing the air conditioner.
- The appliance shall be stored so as to prevent mechanical damage from occurring.

#### R32 Only



- Any person who is involved with working on or breaking into a refrigerant circuit should hold a current valid certificate from an industry-accredited assessment authority, which authorizes their competence to handle refrigerants safely in accordance with an industry recognized assessment specification.
- Servicing shall only be performed as recommended by the equipment manufacturer. Maintenance and repair requiring the assistance of other skilled personnel shall be carried out under the supervision of the person competent in the use of flammable refrigerants.
- The appliance shall be stored in a well-ventilated area where the room size corresponds to the room area as specified for operation.
- Keep any required ventilation openings clear of obstruction.
- The appliance shall be stored in a room without continuously operating open flames (for example an operating gas appliance) and ignition sources (for example an operating electric heater).

## CAUTION INSTRUCTIONS

### CAUTION

- To reduce the risk of minor injury to persons, malfunction, or damage to the product or property when using this product, follow basic precautions, including the following:

### Installation

- Transport the air conditioner with two or more people or use a forklift.
- Install the outdoor unit such that it is protected from direct sunlight. Do not place the indoor unit in a place where it is directly exposed to sunlight via the windows.
- Do not install the air conditioner in an area where it is directly exposed to sea wind (salt spray).
- Install the drain hose properly for the smooth drainage of water condensation.

- Install the air conditioner in a place where the noise from the outdoor unit or the exhaust fumes will not inconvenience the neighbours. Failure to do so may result in conflict with the neighbours.
- Safely dispose of packing materials such as screws, nails, plastic bags or batteries using proper packaging after installation or repair.
- Exercise caution when unpacking or installing the air conditioner.

### **Operation**

- Make sure that the filter is installed before operating the air conditioner.
- Do not drink the water drained from the air conditioner.
- Do not place any object on the air conditioner.
- Do not let the air conditioner run for a long time when humidity is very high or when a door or a window has been left open.
- Do not expose people, animals, or plants to the cold or hot wind from the air conditioner for extended periods of time.
- Do not use the product for special purposes, such as preserving foods, works of art, etc. the air conditioner is designed for consumer purposes, and is not a precision refrigeration system. There is risk of damage or loss of property.

### **Maintenance**

- Use a sturdy stool or ladder when cleaning, maintaining, or repairing the air conditioner at a height.
- Never use strong cleaning agents or solvents or spray water when cleaning the air conditioner. Use a soft cloth.
- Never touch the metal parts of the air conditioner when removing the air filter.
- To clean the interior, contact an authorized service centre or dealer. Using harsh detergents may cause corrosion or damage to the unit.

# OPERATION

## Before Use

### Notes for Operation

- Adjust the direction of the airflow vertically or horizontally to circulate indoor air.
- Speed up the fan to cool or warm indoor air quickly, within a short period of time.
- Turn off the appliance and periodically open windows for ventilation. The indoor air quality may deteriorate if the appliance is used for long durations.
- Clean the air filter once every 2 weeks. Dust and impurities collected in the air filter may block the airflow or reduce the appliance performance.

### Suggestions for Energy Saving

- Do not over-cool the space. This may be harmful for your health and may consume more electricity.
- Block sunlight with blinds or curtains while you are operating the appliance.
- Keep doors or windows closed tightly while you are operating the appliance.

## Product Overviews

### Wall Mounted

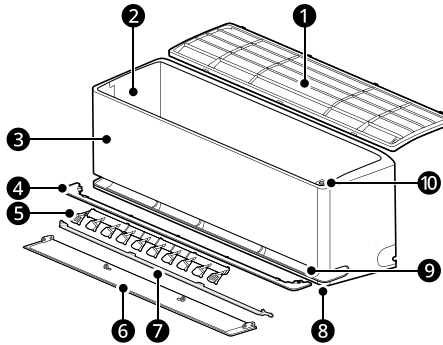

- |                                     |                                |
|-------------------------------------|--------------------------------|
| ❶ Air Filter                        | ❹ Air Deflector (Up-Down Vane) |
| ❷ Air Intake Vents                  | ❺ Air Deflector (Inner Vane)   |
| ❸ Front Cover                       | ❻ Main Air Outlet Vents        |
| ❹ Air Guide                         | ❼ Soft Air Outlet Vents        |
| ❺ Air Deflector (Left-Right Louver) | ❽ Power Button                 |

---

### NOTE

- Dual Vane: ❹ + ❺
  - The number and location of parts may vary depending on the model of the appliance.
  - Features may change depending on the model type.
-

## Preparation before Operation

### Inserting the Batteries into the Wireless Remote Control

Insert AAA (1.5 V) batteries into the wireless remote control.

- 1 Remove the battery cover.

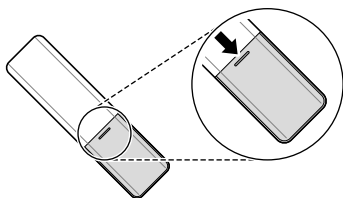

- 2 Insert the new batteries and make sure that the + and - terminals of the batteries are installed correctly.

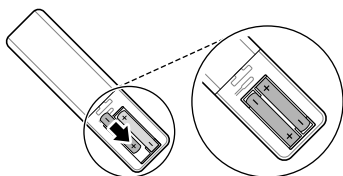

- 3 Reattached the cover by sliding it back into position.

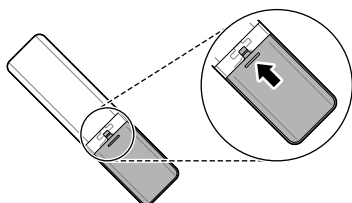

- Do not use batteries other than alkaline.

### Selecting Fahrenheit or Celsius

Set the temperature display to show either Fahrenheit (°F) or Celsius (°C) units.

- 1 Turn the appliance on.

- 2 Press the **Function** button.

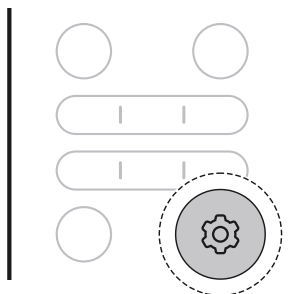

### NOTE

- When the wireless remote control display begins to fade, replace AAA (1.5 V) batteries.
- Do not use old and new batteries together.

## 14 OPERATION

---

- 3** Press the **<** or **>** button until the below icon flashes at the display screen. Then press the **OK** button.

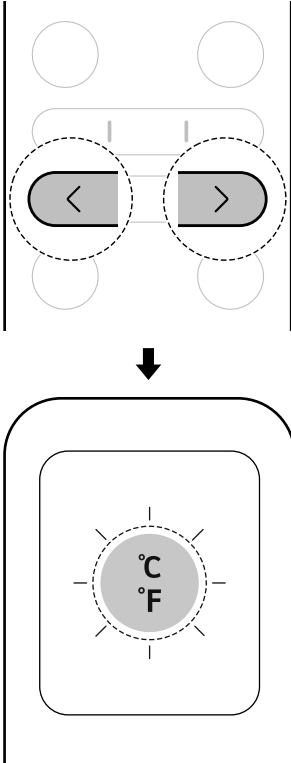

- 4** Press the **<** or **>** button to set either Fahrenheit (°F) or Celsius(°C) units.
- Each time button pressed, the function changes in this order: °C ↔ °F

- 5** Then press the **OK** button.

# Wireless Remote Control Overview

## Wireless Remote Control

You can operate the appliance more conveniently with the wireless remote control.

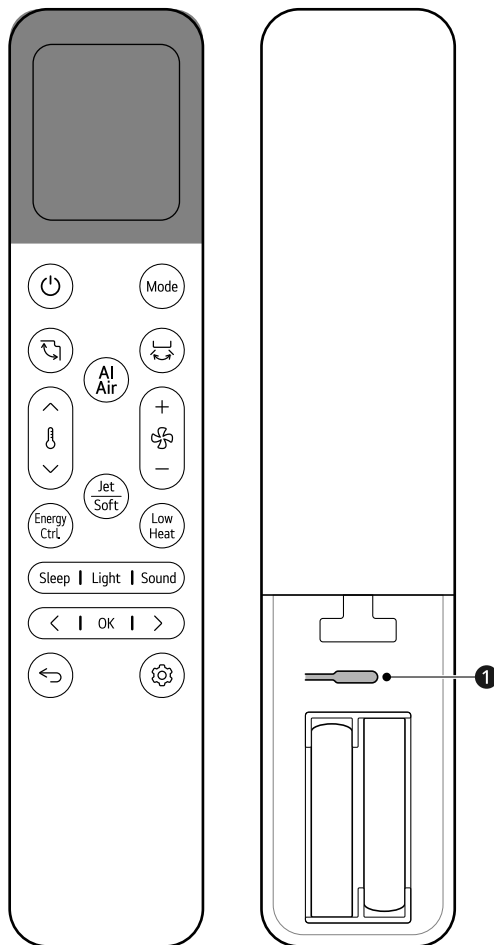

### Image

### Description



#### Power

Turns the appliance on or off.

#### Connecting to LG ThinQ

Press and hold the **Power** button for about 3 seconds to prepare the statue for connecting appliance and Wi-Fi.

## 16 OPERATION



















Image	Description
	<p><b>Mode</b> Selects the desired operation mode.</p> <ul style="list-style-type: none"><li>• Each press changes the modes in this order: <b>Cooling</b> → <b>Auto</b> → <b>Dehumidification</b> → <b>Heating</b> → <b>Fan</b></li></ul>
	<p><b>Up-Down Swing</b> Adjusts the airflow direction up and down.</p> <hr/> <p><b>Cleaning Mode</b> While the remote control and appliance are turned off, press and hold the  button for about 3 seconds to fix the vane for cleaning the vane easily.</p>
	<p><b>Left-Right Swing</b> Adjusts the airflow direction left and right.</p>
	<p><b>AI Air</b> Operate automatically by detecting the surrounding environment and user characteristics.</p>
	<p><b>Temperature <math>\wedge</math>, <math>\vee</math></b> Adjusts the target room temperature.</p>
	<p><b>Fan Speed <math>+</math>, <math>-</math></b> Adjust the fan speed.</p>
	<p><b>Jet/Soft</b> Selects <b>Jet</b> mode or <b>Soft Air</b> function.</p>
	<p><b>Energy Ctrl.</b> Decrease the power input. You can control energy consumption.</p>
	<p><b>Low Heat</b> Operates the heating system to maintain a minimum room temperature.</p>
	<p><b>Sleep</b> Automatically turns the appliance off at a desired time. Use it before sleeping.</p>

Image	Description
	<b>Light</b> Turns the indoor unit display on or off. Adjusting it according to the day or night.
	<b>Sound</b> Turns on or off the notification sound that occur when you set up or change appliance features.
	<b>&lt; &gt;</b> Navigates settings using the left and right buttons.
	<b>OK</b> Sets the special functions.
	<b>Previous</b> When entering the settings, press the <b>Previous</b> button to return the previous setting.
	<b>Function</b> Selects the desired function.
	<b>Reset</b> Resets the wireless remote control setting.

## Using Operating Modes

### Operating with the Wireless Remote Control

Point the wireless remote control towards the signal receiver at the right side of the appliance to operate it.

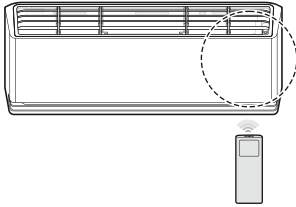

#### NOTE

- The wireless remote control may operate other electronic devices if it is directed towards them. Make sure to point the wireless remote control towards the appliance signal receiver.
- For proper operation, use a soft cloth to clean the signal transmitter and receiver.
- If a function included on the remote is not supported on the appliance, the appliance may not indicate this by buzzing.

### Cooling, Auto, Dehumidification, Heating, Fan Mode

You can change the operating mode when the appliance is turned on.

- 1 Turn the appliance on.

- 2 Press the **Mode** button repeatedly to change the operating mode.

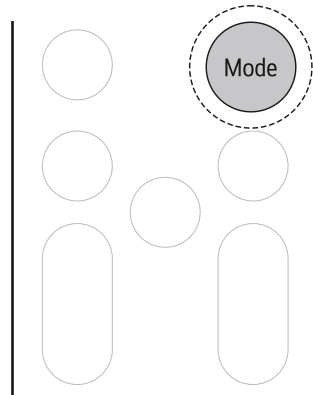

**Cooling mode**



**Auto Operation mode / Auto changerover mode**

\*1 It automates the process of choosing the right settings for your space.



**Dehumidification mode**



**Heating mode**



**Fan mode**

- 3 Press the **▲** or **▼** button to set the target temperature.

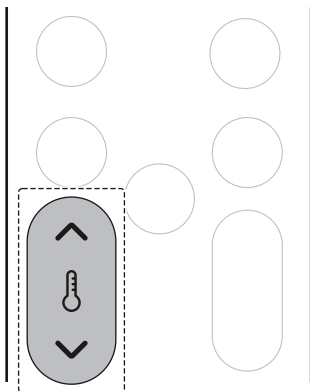

- 2 Press the **Mode** button repeatedly to select the desired mode.

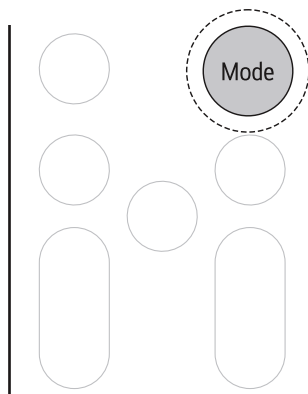

## Notes for Each Operation Mode

### Dehumidification Mode

- You cannot adjust the fan speed.
- In the **Dehumidification** mode, compressor and indoor fan may not operate, to prevent excessive cooling.

### Fan Mode

-  is displayed on the indoor unit.
- You cannot adjust the temperature.

## Jet Mode

You can change the room temperature quickly.

- The **Jet** mode is available with the **Cooling** and **Heating** modes.

- 1 Turn the appliance on.

- 3 Press the **Jet/Soft** button.

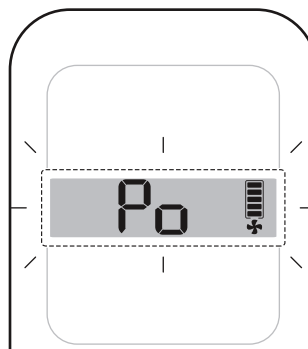
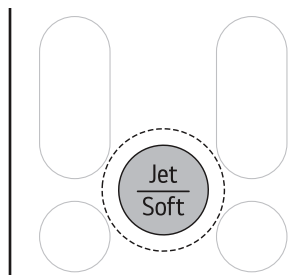

## NOTE

- The **Jet Heating** mode is not available on some models.

### NOTE

- **Jet** mode may operate differently from the wireless remote control display.
- If you select **Jet** mode in **Dehumidification** mode, it will operate in **Jet Cooling** mode.

## Adjusting the Fan Speed

You can adjust the fan speed by pressing the **+** or **-** button repeatedly.

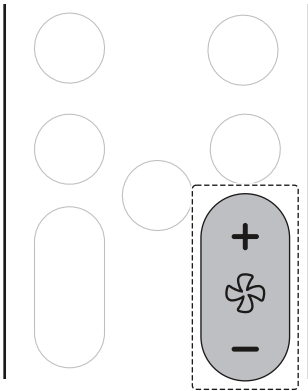

Speed	Wireless Remote Control Icon	Indoor Unit Icon
Auto		-
High		F5
Medium - High		F4
Medium		F3
Medium - Low		F2
Low		F1

### NOTE

- The fan speed of Auto adjusts automatically.
- The indoor unit icons are displayed on some indoor units.
- The indoor unit display shows the fan speed icons for only 5 seconds and returns to the set temperature.

## Adjusting the Airflow Direction

You can adjust the direction of the airflow vertically or horizontally.

## Adjusting the Up-Down Direction

- Press the  button repeatedly to adjust airflow direction.

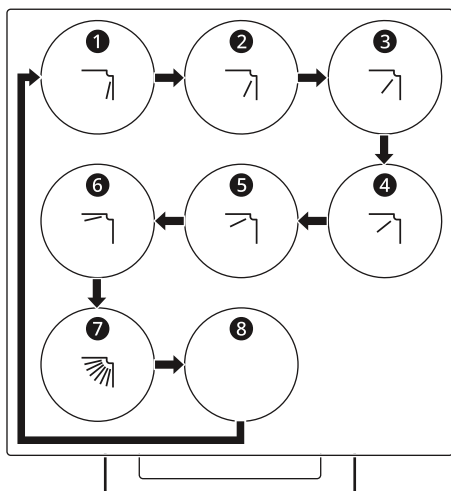
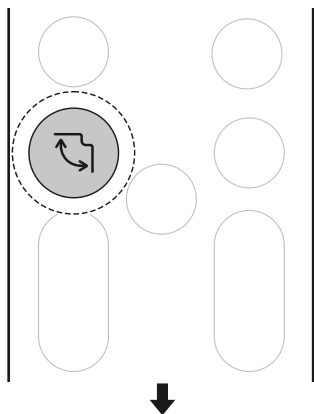

- Select  to adjust the up-down direction of the airflow automatically.

## Adjusting the Left-Right Direction

- Press the  button repeatedly to adjust airflow direction.

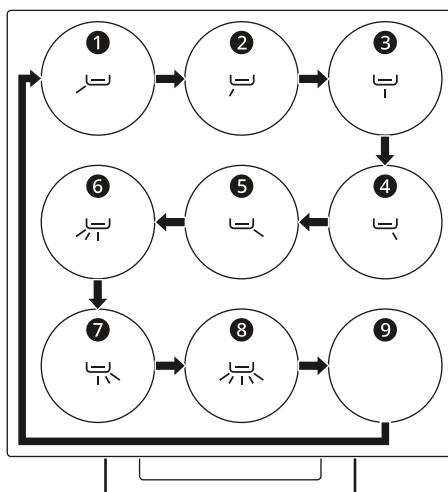
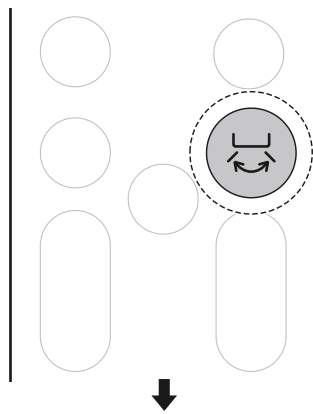

- Select  to adjust the left-right direction of the airflow automatically.

## NOTE

- Adjusting the air deflector arbitrarily may cause appliance failure.
- When restarted, the appliance uses the last set airflow direction. The position of the air deflector may not match the icon displayed on the wireless remote control. When this occurs, adjust the direction of the airflow again.

### NOTE

- This function may operate differently from the wireless remote control display.
- 

## Manual Operation

If your wireless remote control is unavailable, you can turn the appliance on and off by pressing the **Power** button ❶ on the indoor unit.

- Press the **Power** button ❶.

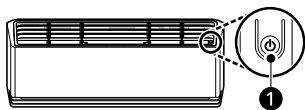

### NOTE

- The fan speed is set to high by default.
  - Features may change depending on the model type.
  - The temperature cannot be altered when using the **Power** button ❶.
  - The temperature is set between 22 °C and 24 °C by default.
- 

## Restoring the Previous Settings

When the air conditioner is turned on again after a power failure, **Auto Restart** function restores the previous settings.

When using the appliance for the first time, **Auto Restart** function is set. You can cancel and set this function by pressing the **Power** button ❶ on the indoor unit.

## Cancelling Auto Restart

- 1 Press and hold the **Power** button ❶ for 6 seconds.

- 2 When the appliance beeps twice, release the **Power** button ❶. The lamp will flash twice. This repeats 4 times.

## Setting Auto Restart

- 1 Press and hold the **Power** button ❶ for 6 seconds.
- 2 When the appliance beeps twice, release the **Power** button ❶. The lamp will flash. This repeats 4 times.

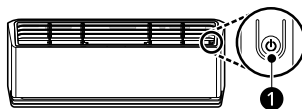

### NOTE

- The feature may change depending on the model type.
  - If you press and hold the **Power** button ❶ for 3 – 5 seconds, instead of 6 seconds, the appliance will switch to the test operation. In the test operation, the appliance blows out strong cooling air for 18 minutes and then returns to factory default settings.
-

## Using Special Functions

### Air Purification Function (On Some Models)

You can supply clean and fresh air using ion particles and the filter.

- 1 Press the **Function** button.

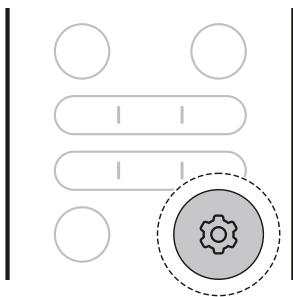

- 2 Press the < or > button until the below icon appears at the bottom of the display screen. Then press the **OK** button.

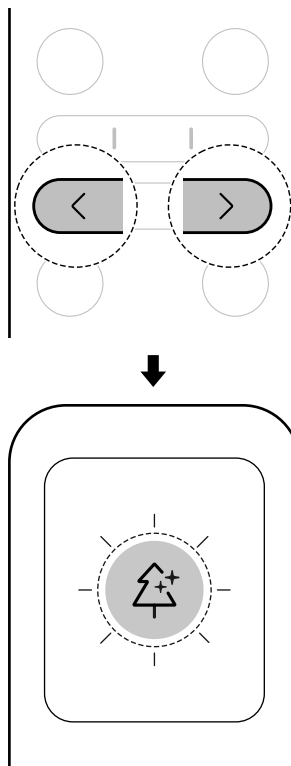

- 3 Press the < or > button to set air purification function.
  - Each time button pressed, the function changes in this order: ON ↔ OFF
- 4 Then press the **OK** button.

Function	Description
Ionizer	Ion particles from Ionizer reduce the surface bacteria and other harmful substances.

## ⚠ WARNING

- Do not touch the ionizer during operation.

## NOTE

- You can use this function without turning the appliance on.

## Active Energy Control Function (On Some Models)

You can decrease the power input.

- Turn the appliance on.
- Press the **Energy Ctrl.** button repeatedly to select the desired step.

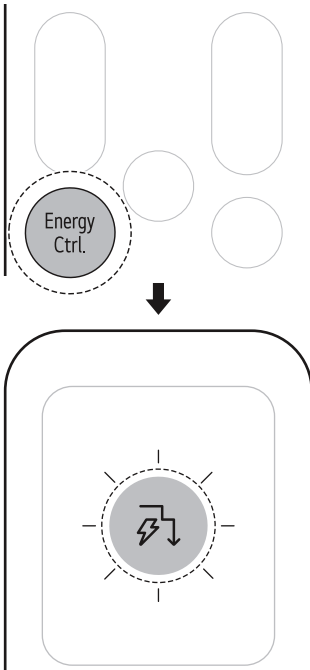

Step	Display Screen	Description
1		The power Input is decreased by 20% compared to rated power input.
2		The power Input is decreased by 40% compared to rated power input.
3 (on some models)		The power Input is decreased by 60% compared to rated power input.

## NOTE

- 80, 60, 40 or L (step 1), LL (step 2) is displayed on some indoor units.
- This function is available with **Cooling** mode.
- Capacity may decrease when the **Active Energy Control** function is selected.
- The target temperature is displayed for about 5 seconds if you press the **▲** or **▼** button.
- The fan speed is displayed for about 5 seconds if you press the **+** or **-** button.

## AI Air Mode

The fan speed and airflow direction change automatically based on learned usage patterns and ambient temperature changes.

If you select the **AI Air** mode, the air conditioner analyzes the surrounding environment to reach the target temperature quickly. The airflow direction and fan speed are automatically adjusted to achieve the comfort settings.

- Turn the appliance on.

## 2 Press the **AI Air** button.

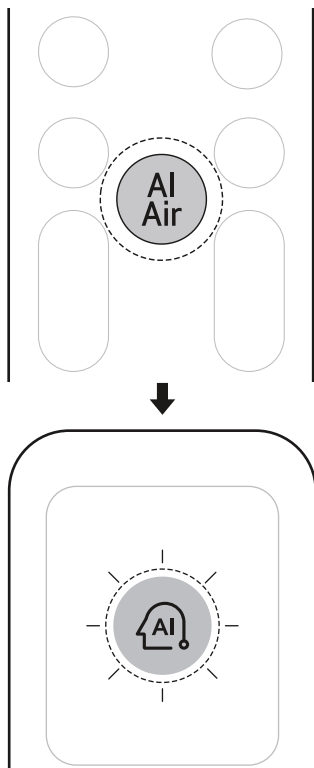

With the **LG ThinQ** application, you can fine-tune the temperature and strength of the airflow.

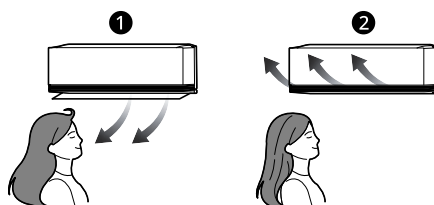

① Normal

② Soft Air

1 Turn the appliance on.

2 Press the **Jet/Soft** button until the below icon appears at the top of the display screen.

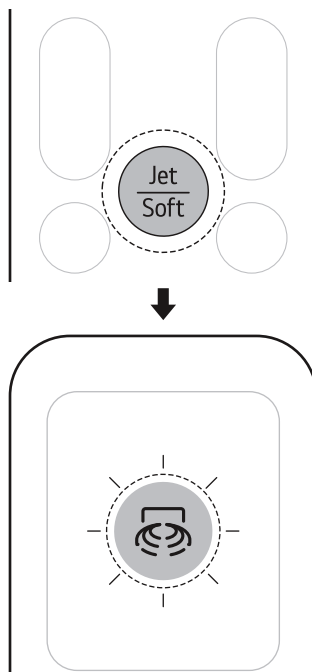

## NOTE

- This function is available with the **Cooling** and **Heating** modes.
- **Ri** is displayed on the display screen.
- To change the target temperature, press the **Temperature** **▲** or **▼** button on the remote control.
- Pressing the **Mode** or **Jet/Soft** buttons while in the **AI Air** mode operates the selected function.
- This function may operate differently depending on the model.

## Soft Air

This feature directs a soft airflow upwards to keep you cool without feeling a draft.

### NOTE

- When the **Soft Air** function is activated, the temperature of the air coming out of the appliance is changed and the airflow is directed upward.
- **Soft Air** function can be used with the **Cooling** and **Fan** modes.
- 50 is displayed on the display screen.
- To change the target temperature, press the **Temperature** **▲** or **▼** button on the remote control.
  - The temperature adjustment range may be limited while using the **Soft Air** function.
- Press the **+** or **-** button to adjust the fan speed.
- The airflow temperature may not increase or decrease depending on the indoor and outdoor temperatures.

## Human Detecting Sensor (On Some Models)

### Direct and Indirect Airflow

This feature detects people and sets either a **Direct** or **Indirect** airflow based on your preferences.

#### • Direct Airflow

After detecting an occupied area, it directs the airflow to the occupied area.

#### • Indirect Airflow

After detecting an occupied area, it directs the airflow to the unoccupied area.

- 1 Turn the appliance on.

- 2 Press the **Function** button.

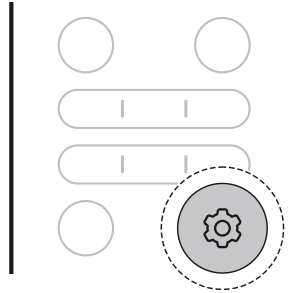

- 3 Press the **<** or **>** button to set the below icon flashes at the bottom of the display screen. Then press the **OK** button.

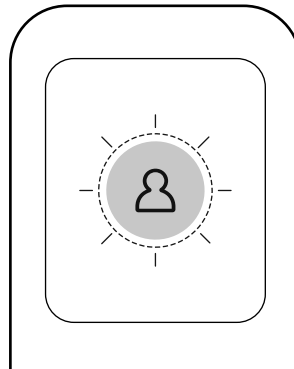
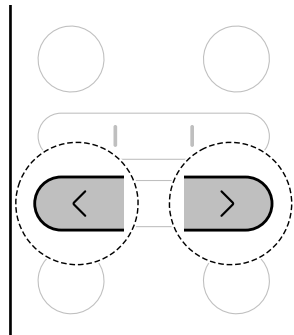

- 4 Press the **<** or **>** button to set direct and indirect function.

- Each time button pressed, the function changes in this order: Direct ↔ Indirect ↔ OFF

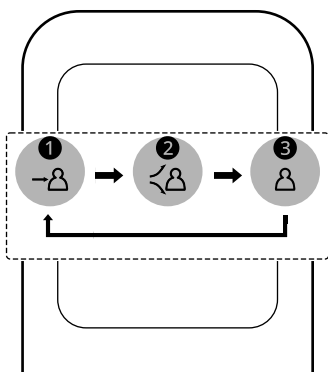
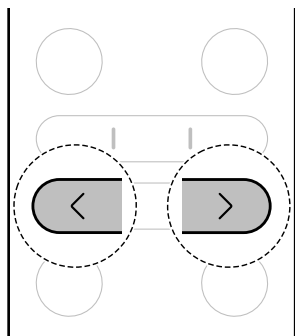

- ① Direct
- ② Indirect
- ③ Off

- Connect the appliance to the **LG ThinQ** application to set the absence detection time and absence detecting mode.

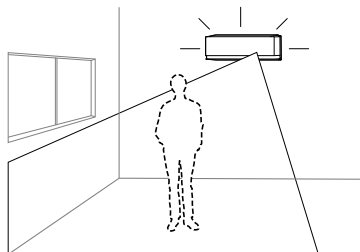

- 1 Turn the appliance on.

- 2 Press the **Function** button.

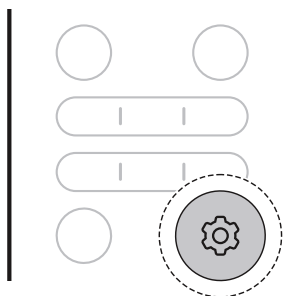

- 5 Then press the **OK** button.

## Absence Detection

It automatically changes to energy saving operation when no one is present.

- If you leave the appliance turned on while you are out, the appliance automatically performs energy saving cooling operation or turns off the power when the absence detection time elapses, saving on electricity bills.

- 3** Press **<** or **>** button to set the below icon flashes at the bottom of the display screen. Then press the **OK** button.

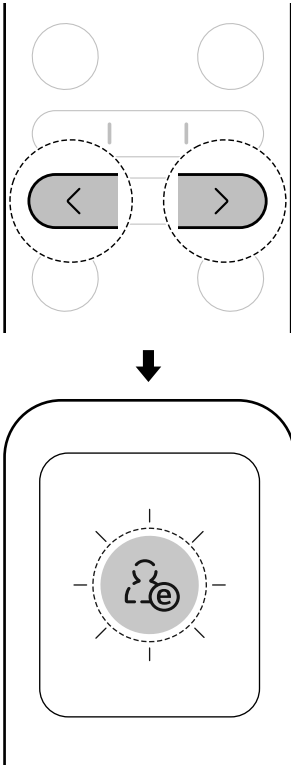

- 4** Press the **<** or **>** button to set absence detection function.
- Each time button pressed, the function changes in this order: ON ↔ OFF
- 5** Then press the **OK** button.

### NOTE

- The **Direct and Indirect Airflow** operation are available with **Cooling, Heating** mode.
- The sensitivity of the radar sensor may vary depending on the indoor environment and conditions, including:
  - If there is little movement, such as while watching TV or sleeping

- If you are sitting on the floor close to the appliance
- If you are in a location far from the appliance approximately 5 m (16 ft) or more
- Moving objects such as fans, robot vacuum cleaners, or companion animals may be mistaken for people.

## Sleep Timer

You can set the appliance to turn off automatically after a set time. The appliance will automatically change the temperature, fan speed and airflow direction.

This function can be set when the appliance is turned on.

- 1** Turn the appliance on.
- 2** Press the **Sleep** button.

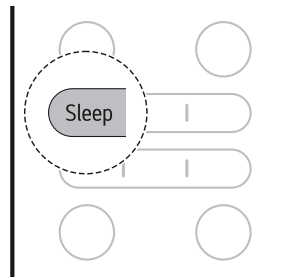

- 3** Press the **<** or **>** button to set the desired time. Then press the **OK** button.

- Starting from 30 minutes, the sleep timer can be set in hourly increments up to 12 hours.

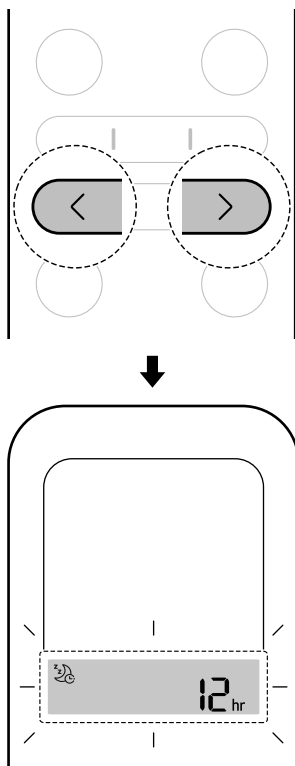

comfortable sleep. The temperature decreases up to 2 °C from the preset temperature.

## On and Off Timer

You can set the appliance to turn on and off automatically at a desired time.

The **On Timer** and **Off Timer** can be set together.

## Setting the On Timer

You can set or cancel the function whether the appliance is turned on or off.

- 1 Press the **Function** button.

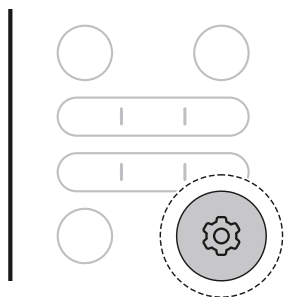

## NOTE

- Indoor unit display shows the set time from 1 Hr to 12 Hr for only 5 seconds then disappears on some models.
- In the **Cooling** and **Dehumidification** mode, the temperature increases by 1 °C after 30 minutes and an additional 1 °C after another 30 minutes for a more comfortable sleep. The temperature increases up to 2 °C from the preset temperature and up to 30 °C.
- Although the remark for fan speed on the display screen may be changed, the fan speed is adjusted automatically.
- In the **Heating** mode, the temperature decreases by 1 °C after 1 hours and an additional 1 °C after another 1 hours for a more

## 30 OPERATION

- 2** Press the **<** or **>** button until the below icon flashes at the bottom of the display screen. Then press the **OK** button.

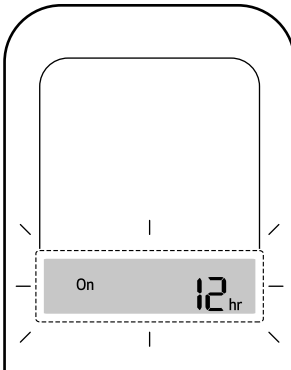
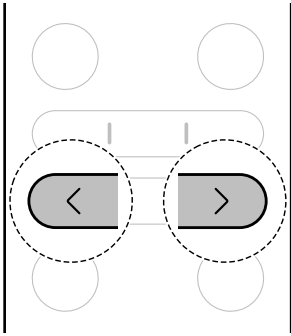

- 3** Press the **<** or **>** button to set the desired time. Then press the **OK** button.
- The time can be set up to 24 hours.

### Setting the Off Timer

You can set or cancel the function whether the appliance is turned on or off.

- 1** Press the **Function** button.

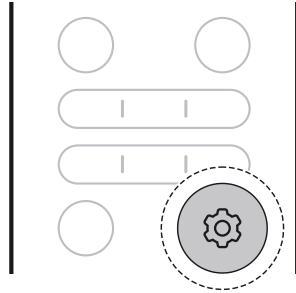

- 2** Press the **<** or **>** button until the below icon flashes at the bottom of the display screen. Then press the **OK** button.

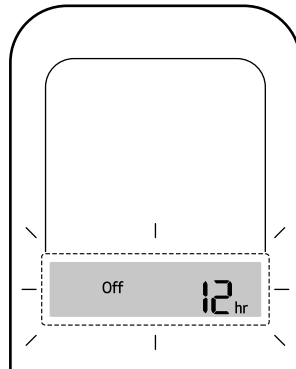
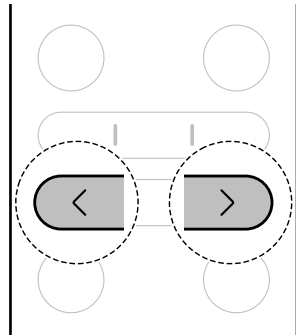

- 3** Press the **<** or **>** button to set the desired time. Then press the **OK** button.
- The time can be set up to 24 hours.

## Cancelling the Timer Setting

You can cancel all timer settings.

- 1 Press the **Function** button.

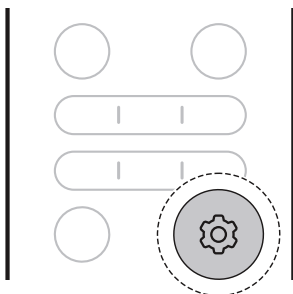

- 2 Press the < or > button until the below icon flashes at the bottom of the display screen. Then press the **OK** button.

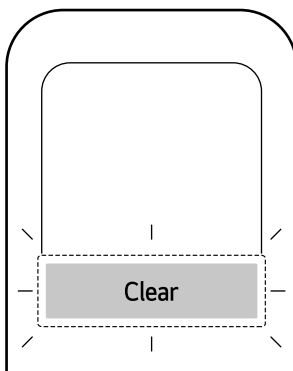
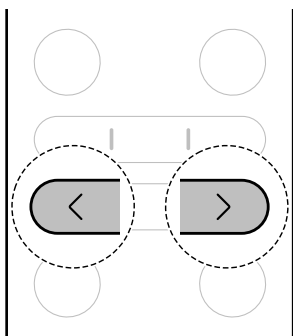

## Mute Function

You can turn on or off the buzzer sound to notify you when you set or change the function of the air conditioner.

- Press the **Sound** button to set the **Mute** function.

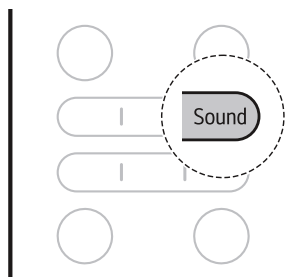

### NOTE

- Set the function each time, the function changes on and off.
- When the Mute is set,  $\square F$  appears for a moment on the indoor unit display and the buzzer sound turned off.
- This function may operate differently depending on the model.

## Light Off Function

You can set the brightness of the indoor unit display screen.

- Press the **Light** button to set the light off function.

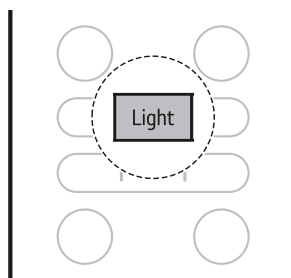

### NOTE

- The button turns the display screen on or off.
- If the brightness of an indoor unit's display is set to off, pressing a button on the wireless remote control automatically turns the display on for a while.
- This function may operate differently depending on the model.

### Silent Function (On Some Models)

You can reduce the noise of the outdoor unit so that it will not inconvenience neighbours.

**1** Turn the appliance on.

**2** Press the **Function** button.

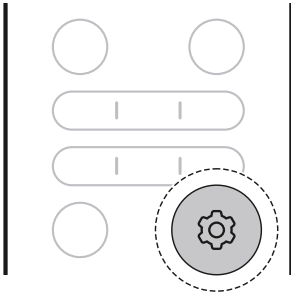

**3** Press the **<** or **>** button until the below icon flashes at the bottom of the display screen. Then press the **OK** button.

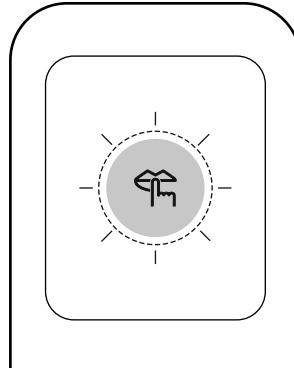
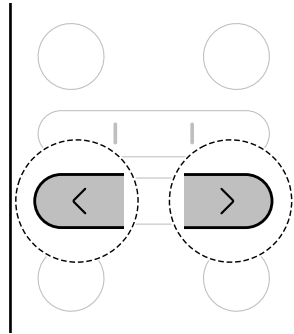

**4** Press the **<** or **>** button to set the silent function.

- Each time button pressed, the function changes in this order: ON ↔ OFF

**5** Then press the **OK** button.

### NOTE

- This function is disabled when you press the **Mode** or **Jet/Soft** button.
- This function is available with the **Cooling**, **Heating** and **Auto Changeover** modes.

## Low Heating Function (On Some Models)

You can operate the heating system to maintain a minimum room temperature and prevent objects in the room from freezing when you are away from home for extended periods.

1 Turn the appliance on.

2 Press the **Low Heat** button.

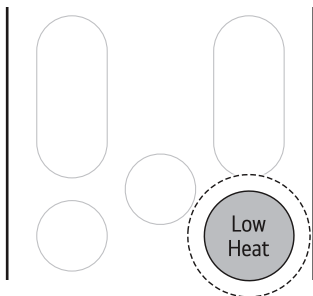

### NOTE

- This function is available with the **Heating** mode.
- To return to the **Heating** mode, press the **Fan Speed +**, **-** or **Mode** button.
- If the **Jet/Soft** button is pressed while the **Low Heating** function is running, the function is disabled and the **Jet Heating** mode is turned on immediately (on **Jet Heating** models).
- If an error occurs, operation may be interrupted to avoid damage to the appliance.
- The **Jet/Soft** and **Up-Down Swing** buttons cannot be used while the **Low Heating** function is in operation.
- The target temperature is displayed on the indoor unit.
- The temperature can be set 8 °C and 15 °C.

## Checking Room Temperature

You can check the current room temperature.

1 Turn the appliance on.

2 Press the **Function** button.

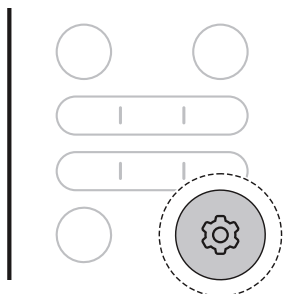

3 Press the **<** or **>** button until the below icon flashes at the bottom of the display screen. Then press the **OK** button.

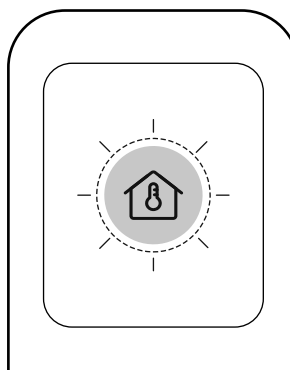
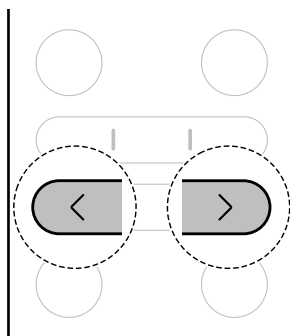

---

### NOTE

- The room temperature displayed for 5 seconds before returning to the previous display.
  - This function may operate differently depending on the model.
-

# SMART FUNCTIONS

## LG ThinQ Application

This feature is only available on models with Wi-Fi. The **LG ThinQ** application allows you to communicate with the appliance using a smartphone.

## LG ThinQ Application Features

### Common features

Communicate with the appliance from a smartphone using the **LG ThinQ** application.

- **Smart Diagnosis**
  - If you experience a problem while using the appliance, this smart diagnosis feature will help you diagnose the problem.

### Additional features

More features are available if your appliance is connected to Wi-Fi.

- Settings
  - Allows you to set various options on the appliance and in the application.

### NOTE

- In the following cases, you must update the network information for each appliance in the **LG ThinQ** application under **Device Cards** → **Settings** → **Change Network**.
  - wireless router is changed
  - wireless router password is changed
  - Internet service provider is changed
- The application is subject to change for appliance improvement purposes without notice to users.
- Functions may vary by model.

## Installing LG ThinQ Application and Connecting an LG Appliance

### Models with QR Code

Scan the QR code attached to the product using the camera or a QR code reader application on your smartphone.



### Models without QR Code

- 1 Search for and install the **LG ThinQ** application from the Google Play Store or Apple App Store on a smartphone.
- 2 Run the **LG ThinQ** application and sign in with your existing account or create an LG account to sign in.
- 3 Touch the add (+) button on the **LG ThinQ** application to connect your LG appliance. Follow the instructions in the application to complete the process.

### NOTE

- To verify the Wi-Fi connection, check that the Wi-Fi indicator on the control panel is lit.
- The appliance supports 2.4 GHz Wi-Fi networks only. To check your network frequency, contact your Internet service provider or refer to your wireless router manual.

## NOTE

- **LG ThinQ** is not responsible for any network connection problems or any faults, malfunctions, or errors caused by network connection.
- The surrounding wireless environment can make the wireless network service run slowly.
- If the distance between the appliance and the wireless router is too far, the signal strength becomes weak. It may take a long time to connect or installation may fail.
- If the appliance is having trouble connecting to the Wi-Fi network, it may be too far from the router. Purchase a Wi-Fi repeater (range extender) to improve the Wi-Fi signal strength.
- The network connection may not work properly depending on the Internet service provider.
- The Wi-Fi connection may not connect or may be interrupted because of the home network environment.
- The appliance cannot be connected due to problems with the wireless signal transmission. Unplug the appliance and wait about a minute before trying again.
- If the firewall on your wireless router is enabled, disable the firewall or add an exception to it.
- The wireless network name (SSID) should be a combination of English letters and numbers. (Do not use special characters.)
- Smartphone user interface (UI) may vary depending on the mobile operating system (OS) and the manufacturer.
- If the security protocol of the router is set to **WEP**, you may fail to set up the network. Please change it to other security protocols (**WPA2** is recommended) and connect the product again.

- When new features are available, an update notification will appear on the display as shown below when you turn on the appliance.

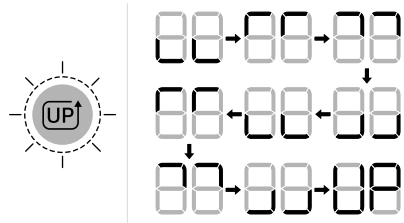

- After the update, the appliance function may change from what is indicated in the user manual.

- 1 Once you get an update notification, you will also receive an update notification on your smartphone.
- 2 Tap the update notification on your smartphone to enter the **Feature Updates** screen in the **LG ThinQ** app.
- 3 Once you enter the **Feature Updates** screen, select the new features and tap the **update** button.
  - The progress of the update can be checked on the appliance's control panel.
  - Do not unplug the power plug of the appliance during the update, as it will interrupt the process.
- 4 After the update, to change the detailed settings of the updated features, refer to the guide within the **LG ThinQ** app.

## Update Your Appliance

You can update your appliance with new features through the **LG ThinQ** app.

## Window Open Detection (On Some Models/LG ThinQ)

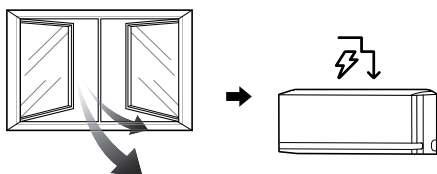

When a window is opened or outside air comes in, the temperature change can be detected and **Active Energy Control** mode is turned on.

To use the **Window Open Detection** function or set the **Active Energy Control Turn Off Time**, connect the appliance to the **LG ThinQ** application.

- If a window is opened, 80, 60 or 40 appear on the indoor unit display.

### NOTE

- The **Window Open Detection** function can be used with the **Cooling** and **Heating** modes.
- The **Window Open Detection** function is cancelled in the following situations.
  - If the appliance recognizes that the window is closed
  - If the **Active Energy Control Turn Off Time** has elapsed
  - If the operating mode is changed
- The **Window Open Detection** function does not work in the following cases.
  - If **Cooling** and **Heating** operation is run too soon after turning on the appliance
  - If the temperature difference between the indoors and outdoors is not large
  - If there is insufficient ventilation through the windows

## All Cleaning (On Some Models/LG ThinQ)

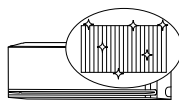

By repeatedly freezing and thawing the heat exchanger of the air conditioner, contaminants such as dust are washed away and the appliance is kept clean.

After cleaning, it reduces moisture inside the indoor unit.

On some indoor units, **RL** appears on the display of the indoor unit.

### NOTE

- The **All Cleaning** function will end after the appliance has dried.
- If the humidity in the room is high when the **All Cleaning** function is operating, the area near the indoor unit may become foggy.
- The **All Cleaning** function can be used indoors at 21 °C to 32 °C and outdoors at 21 °C to 37 °C. The **All Cleaning** function is a hygiene management function, not a cooling function, so the usage conditions may vary from the guaranteed cooling temperature of the appliance.
- If the **All Cleaning** function is operated at a temperature outside of the allowable range, alarms in the **LG ThinQ** application and the function does not work.
- The **All Cleaning** function is available even when the appliance is running.
- If you press the **Power** button on the appliance or on the remote control during the **All Cleaning**, the **All Cleaning** function is deactivated.
- During the **All Cleaning**, a “tick-tick-” or “tack-tack” noise may be heard as the appliance expands or contracts.
- After the **All Cleaning**, the appliance will automatically shut off. When the power is turned back on, it will operate in **Cooling** mode.

**NOTE**

- If the **Timer** function is set, the **All Cleaning** function may not operate properly.
- Cool air comes out of the outlet when the **All Cleaning** function is activated.

**AI kW Manager (On Some Models/LG ThinQ)**

The air conditioner power consumption is automatically adjusted based on a schedule and target power consumption set by the user.

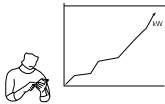

⏸ appears on the display of the indoor unit on some models.

**NOTE**

- When using **AI kW Manager** function, cooling or heating output may be reduced, depending on the remaining target power amount.
- When the target electricity consumption is exceeded, the **AI kW Manager** function is disabled.
- The power usage shown through the **LG ThinQ** application may differ from the actual power usage shown on your utility bill.
- Power consumption information may vary depending on the appliance.
- Power consumption may differ from results measured using other measuring devices.
- Depending on the environment in which the device is installed, measured power consumption may vary.
- Measured power consumption may vary depending on the usage environment or usage method of the home appliance.
- When setting the usage time, the appliance does not automatically turn on or off.

- Even during the operation of the **AI kW Manager** function, the function set with the remote control is reflected first.
- Actual usage may differ.

**Sleep+ (On Some Models/LG ThinQ)**

Use it before sleeping. The appliance will automatically learn and adjust the temperature and fan speed to create an even more personalized sleep environment.

**NOTE**

- This function can be set when the appliance is turned on.
- This function is available with the **Cooling** mode.

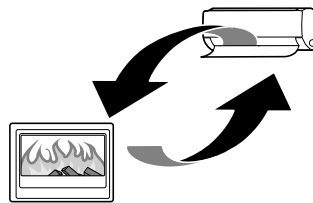
**Fireplace (On Some Models/LG ThinQ)**

The air conditioner circulates air throughout the space in **Fan** mode, supporting other heat sources. Once the target temperature is reached, heating stops, and the fan circulates warm air.

FP appears on the display of the indoor unit.

To use **Fireplace** function, connect the appliance to the **LG ThinQ** application.

## NOTE

- This function is available with the **Heating** mode.
- In **Fireplace** function, fan speed and airflow direction follow the settings from previous **Heating** mode and can be adjusted by pressing the **+**, **-**, **↶** or **↷** buttons.
- If the room temperature decrease or if the target temperature setting is increased, the air conditioner will automatically return to the **Heating** mode.
- The **Fireplace** function may not operate when other specific functions are in use.
- When connected to the Multi Outdoor unit, this functions may not be supported.

## Radio Equipment Specifications

Type	Operating Frequency Range	Output Power (Max.)
Wireless LAN	2400 MHz ~ 2483.5 MHz	< 100 mW
Bluetooth*1		

\*1 This feature is only available on some models.

Wireless function S/W version: V 1.0

For consideration of the user, this device should be installed and operated with a minimum distance of 20 cm between the device and the body.

## Radar module specifications

This feature is only available on models with radar sensor.

Model Name	Frequency Range	Output Power (Max)
RSM V2	61.0 GHz ~ 61.5 GHz	6.27 dBm

## Open Source Software Notice Information

To obtain the source code that is contained in this product, under GPL, LGPL, MPL, and other open source licenses that have the obligation to disclose source code, and to access all referred license terms, copyright notices and other relevant documents, please visit <https://opensource.lge.com>.

LG Electronics will also provide open source code to you on CD-ROM for a charge covering the cost of performing such distribution (such as the cost of media, shipping, and handling) upon email request to [opensource@lge.com](mailto:opensource@lge.com).

This offer is valid to anyone in receipt of this information for a period of three years after our last shipment of this product.

## Diagnosis Using LG ThinQ

Use this feature to help you diagnose and solve problems with your appliance.

## NOTE

- For reasons not attributable to LGE's negligence, the service may not operate due to external factors such as, but not limited to, Wi-Fi unavailability, Wi-Fi disconnection, local app store policy, or application unavailability.
- The feature may be subject to change without prior notice and may have a different form depending on where you are located.

### Using LG ThinQ to Diagnose Issues

If you experience a problem with your Wi-Fi equipped appliance, it can transmit troubleshooting data to a smartphone using the **LG ThinQ** application.

- Launch the **LG ThinQ** application and select the **Smart Diagnosis** feature in the menu. Follow the instructions provided in the **LG ThinQ** application.

### Using Audible Diagnosis to Diagnose Issues

Follow the instructions below to use the audible diagnosis method.

- Launch the **LG ThinQ** application and select the **Smart Diagnosis** feature in the menu. Follow the instructions for audible diagnosis provided in the **LG ThinQ** application.

**1** Plug the power plug in the outlet properly.

**2** Place the mouthpiece of your smartphone close to the appliance.

**3** Press the **Function** button.

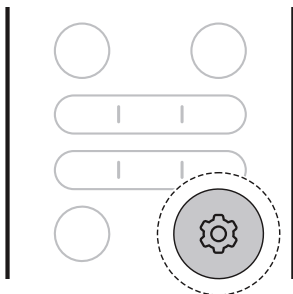

**4** Press the **<** or **>** button until the below icon flashes at the bottom of the display screen. Then press the **OK** button.

- Keep the smartphone in place until the data transfer has finished.

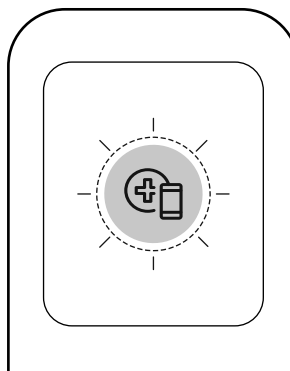
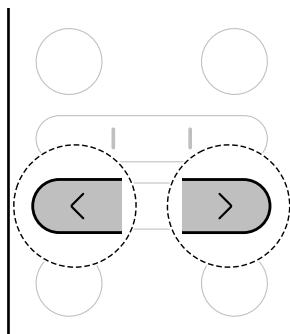

**5** After the data transfer is complete, the diagnosis will be displayed in the application.

#### NOTE

- For best results, do not move the phone while the tones are being transmitted.
- Be sure to keep ambient noise to a minimum or the phone may not correctly receive the buzzer beeps from the indoor unit.

# MAINTENANCE

## Cleaning

### **⚠ WARNING**

- Before cleaning or performing maintenance, disconnect the power supply and wait until the fan stops.

## Cleaning Interval

### Cleaning the Appliance

If the appliance will not be used for an extended period of time, dry the appliance to maintain it in the best condition. Clean the appliance regularly to maintain optimal performance and to prevent possible breakdown.

- Dry the appliance in **Fan** mode for 3 to 4 hours and disconnect the power. There may be internal damage if moisture is left in the appliance's components.
- Before using the appliance again, dry the inner components of the appliance in **Fan** mode for 3 to 4 hours. This will help to reduce the odour generated from moisture.

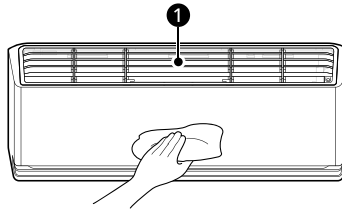

1 Air Filter

### NOTE

- The feature may vary depending on the model type.

Type	Description	Interval
Indoor unit	Clean the surface of the indoor unit using a soft, dry cloth.	Regularly
	Have a professional clean the condensate drain pan.	Once a year
	Have a professional clean the condensate drain pipe.	Every 4 months
	Replace the wireless remote control batteries.	Once a year

## 42 MAINTENANCE

---

Type	Description	Interval
Outdoor unit	Have a professional clean the heat exchanger coils and the panel vents. (Consult with technician.)	Once a year
	Have a professional clean the fan.	Once a year
	Have a professional clean the condensate drain pan.	Once a year
	Have a professional verify that all the fan assembly is firmly tightened.	Once a year
	Clean the electrical components with compressed air.	Once a year

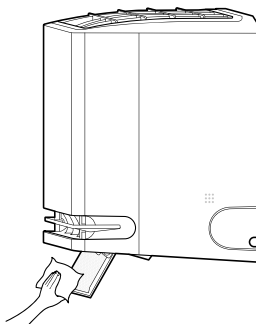

## Cleaning the Air Deflector

- 1 Turn off the appliance.
- 2 Press and hold the  button for about 3 seconds to open the air deflector for cleaning it easily.
- 3 Clean the air deflector using a soft, dry cloth.



- 4 Press and hold the  button for about 3 seconds to close the air deflector.

### NOTE

- When you press the  button while this function is turned on, it cannot turn on the appliance.
  - If you press  button repeatedly, you can turn on the appliance.

## Cleaning the Filter and Other parts

Type	Description	Interval
Air filter	Clean with a vacuum or hand wash.	2 weeks
Allergy filter	Clean with a vacuum or brush.	Every 6 months
Ionizer (on some models)	Use a dry cotton bud to clean dust.	Every 6 months

### NOTE

- Never use water that is higher than 40 °C when you clean the filters. It may cause deformation or discolouration.
- Never use volatile substances when you clean the filters. They may damage the surface of the appliance.

---

### **NOTE**

- Do not wash the Allergy filter with water, because the filter can be damaged (on some models).
-

## Using Auto Clean+ Function

In the **Cooling** and **Dehumidification** modes, moisture is generated inside the indoor unit. You can reduce that moisture.

**1** Turn the appliance on.

**2** Press the **Function** button.

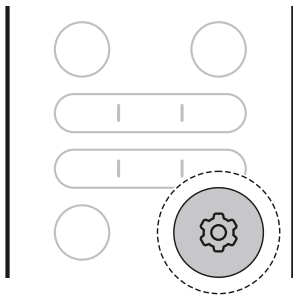

**3** Press the **<** or **>** button until the below icon flashes at the bottom of the display screen. Then press the **OK** button.

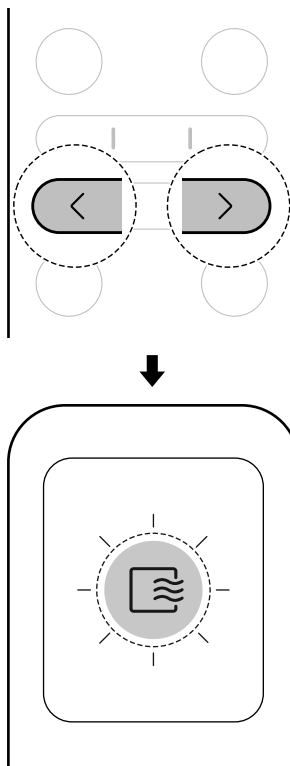

**4** Press the **<** or **>** button to set the desired status of **Auto Clean+** function.

- Each time button pressed, the function changes in this order: Sto ↔ ON ↔ OFF

**5** Then press the **OK** button.

### NOTE

- The **Auto Clean+** function is set up when you purchased the appliance. If you don't want to use this function, turn it off.
- The **Auto Clean+** time is automatically set according to the appliance usage conditions, and the progress status is displayed as the remaining minutes on the indoor unit display.

**NOTE**

- The **Auto Clean+** time is up to 20 minutes.
- The drying condition inside the appliance may be different depending on the temperature or humidity of the indoor air.
- To most effectively dry the inside of the appliance, operate the appliance in **Fan** mode for more than 1 hour.
- Once the **Auto Clean+** function is set, it remains enabled until turned off.
- If the appliance will not be used for a long period of time, run **Fan** mode for more than 1 hour to completely dry the inside of the appliance before storing it.
- You can set the **Auto Clean+** function even when the appliance is not operating.

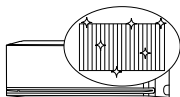
**Freeze Cleaning (On Some Models)**

By repeatedly freezing and thawing the heat exchanger of the air conditioner, contaminants such as dust are washed away and the appliance is kept clean.

FC appears on the display of the indoor unit and the cleaning progress from 0 to 99 is displayed.

- 1 Press the **Function** button.

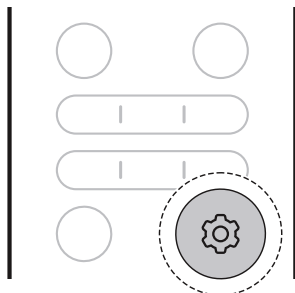

- 2 Press the < or > button until the below icon flashes at the display screen. Then press the **OK** button.

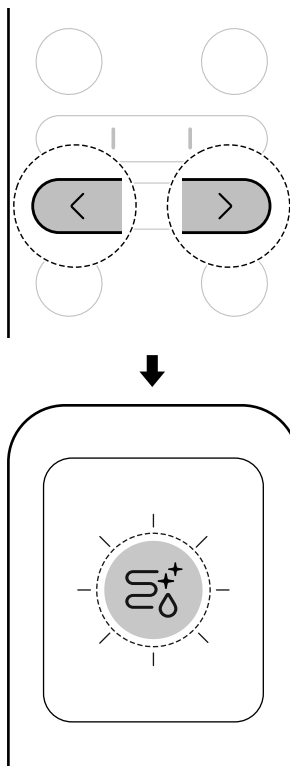
**NOTE**

- The **Freeze Cleaning** function will end after the appliance has dried.
- If the humidity in the room is high when the **Freeze Cleaning** function is operating, the area near the indoor unit may become foggy.
- The **Freeze Cleaning** function can be used indoors at 21 °C to 32 °C and outdoors at 21 °C to 37 °C. The **Freeze Cleaning** function is a hygiene management function, not a cooling function, so the usage conditions may vary from the guaranteed cooling temperature of the appliance.
- If the **Freeze Cleaning** function is operated at a temperature outside of the allowable range, a beep sounds 5 times and the function does not work.

- The code in the image below will be displayed on some indoor units.

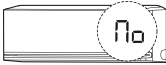

- The **Freeze Cleaning** function is available even when the appliance is running.
  - If you press the **Power** button on the appliance or on the remote control during the **Freeze Cleaning**, the **Freeze Cleaning** function is deactivated.
  - During the **Freeze Cleaning**, a “tick-tick-” or “tack-tack” noise may be heard as the appliance expands or contracts.
  - After the **Freeze Cleaning**, the appliance will automatically shut off. When the power is turned back on, it will operate in **Cooling** mode.
  - If the **Timer** function is set, the **Freeze Cleaning** function may not operate properly.
  - Cool air comes out of the outlet when the **Freeze Cleaning** function is activated.
-

## Removing and Replacing the Air Filter

### NOTE

- Do not bend the air filter, as it may break.
- Assemble the air filter properly to prevent dust and other substances from entering the appliance.
- The number and location of hooks may vary depending on the model of the appliance.

- 1 Turn off the power to the appliance.
- 2 Locate the knobs of the air filter on the top front of the appliance.

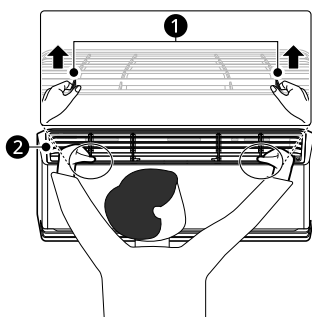

- 1 Knobs
- 2 Air Filter

- 3 Pull the knobs upward slightly and then lift the entire filter to remove it.

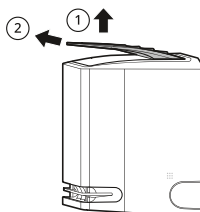

- 4 Insert the hooks on the air filter into the slots on the back of the front panel.

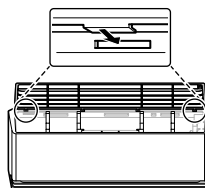

- 5 Push the hooks down until they click into place.

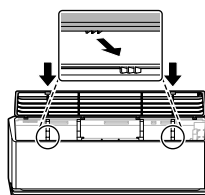

- 6 To make sure the filter is assembled properly, press down along the entire front length of the filter.

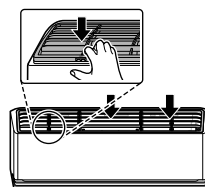

## Cleaning the Air Filter

Clean the air filter once every 2 weeks, or more if needed.

- 1 Remove the air filter from the appliance.

- 2** Clean the air filter with a vacuum cleaner or wash it with lukewarm water and a mild detergent.

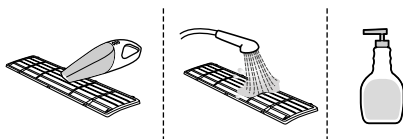

- 3** Dry the filter in the shade.

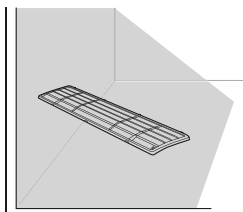

**NOTE**

- Do not operate the appliance without the filter in place.

**Cleaning the Allergy Filter (On Some Models)**

**NOTE**

- The number and location of parts may vary depending on the model of the appliance.
- Features may change depending on the model type.

- 1** Turn off the power to the appliance.

- 2** Remove the air filter from the indoor unit.

- 3** Remove the allergy filter from the indoor unit.

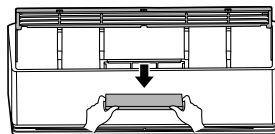

- 4** Clean the filter using a vacuum cleaner.
- Do not wash the allergy filter with water.

- 5** Insert the allergy filter.

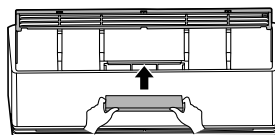

- 6** Assemble the air filter.

- 7** Check the side of the front cover to make sure that the air filter are assembled correctly.

**Removing and Replacing the Air Guide**

**NOTE**

- The number and location of hooks may vary depending on the model of the appliance.

- 1** Turn off the power to the appliance.

- 2 Pull out the air guide at the front of the indoor unit.

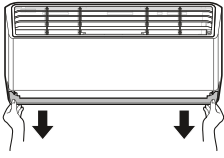

- 3 Insert the hooks on the air guide into the slots.

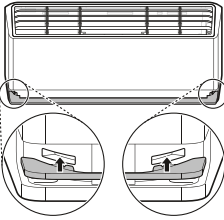

- 4 Push the hooks until the click into place.

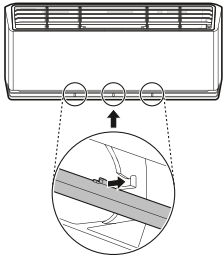

### Cleaning the Air Guide

- 1 Remove the air guide from the appliance.

- 2 Clean the air guide using a soft or dry cloth.

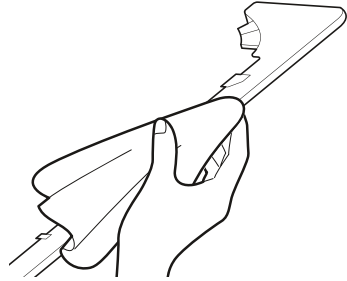

### Cleaning the Ionizer (On Some Models)

- 1 Turn off the appliance.

- 2 Press and hold the **Up-Down Swing** button for about 3 seconds to open the air deflector.

- 3 Clean the ionizer using a dry cotton bud.

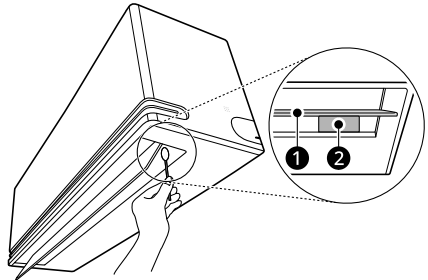

① Air Deflector

② Ionizer

- 4 Press and hold the **Up-Down Swing** button for about 3 seconds to close the air deflector.

---

**NOTE**

- When you press the **Power** button while this function is turned on, it cannot turn on the appliance.
  - If you press **Power** button repeatedly, you can turn on the appliance.
-

# TROUBLESHOOTING

## Before Calling for Service

Please check the following before you contact the service centre. If the problem persists, contact your local service centre.

### NOTE

- Some functions may not be supported, depending on the model.

## Self-Diagnosis Function

This appliance has a built-in **self-diagnosis** function. If an error occurs, the lamp of the indoor unit will flash in 2-second intervals. If this occurs, contact your local dealer or service centre.

## Operation

Symptoms	Possible Cause & Solution
<b>The appliance does not work normally.</b>	<b>Burning smell and strange sounds are coming from the appliance.</b> <ul style="list-style-type: none"> <li>• Turn off the appliance, switch off or disconnect the power supply, and contact the service centre.</li> </ul>
	<b>Water leaks from the indoor unit even when the humidity level is low.</b> <ul style="list-style-type: none"> <li>• Turn off the appliance, switch off or disconnect the power supply, and contact the service centre.</li> </ul>
	<b>The power cable is damaged or it is generating excessive heat.</b> <ul style="list-style-type: none"> <li>• Turn off the appliance, switch off or disconnect the power supply, and contact the service centre.</li> </ul>
	<b>A switch, a circuit breaker (safety, ground) or a fuse is not operating properly.</b> <ul style="list-style-type: none"> <li>• Turn off the appliance, switch off or disconnect the power supply, and contact the service centre.</li> </ul>
	<b>The appliance generates an error code from its self-diagnosis.</b> <ul style="list-style-type: none"> <li>• Turn off the appliance, switch off or disconnect the power supply, and contact the service centre.</li> </ul>
<b>The fan speed cannot be adjusted.</b>	<b>The Jet mode is selected.</b> <ul style="list-style-type: none"> <li>• In some operating modes, you cannot adjust the fan speed. Select an operating mode in which you can adjust the fan speed.</li> </ul>
<b>The temperature cannot be adjusted.</b>	<b>The Fan mode or Jet mode is selected.</b> <ul style="list-style-type: none"> <li>• In some operating modes, you cannot adjust the temperature. Select an operating mode in which you can adjust the temperature.</li> </ul>

Symptoms	Possible Cause & Solution
<b>The appliance stops during operation.</b>	<b>The appliance is suddenly turned off.</b> <ul style="list-style-type: none"> <li>The <b>Off Timer</b> function may have timed out, which turns the appliance off. Check the timer settings.</li> </ul>
	<b>A power failure has occurred during operation.</b> <ul style="list-style-type: none"> <li>Wait for the power to come back on. If you have the <b>Auto Restart</b> function enabled, your appliance will resume its last operation several minutes after power is restored.</li> </ul>
<b>The appliance does not work.</b>	<b>The appliance is unplugged.</b> <ul style="list-style-type: none"> <li>Check whether the power cord is plugged into the outlet or the power isolators are switched on.</li> </ul>
	<b>A fuse exploded or the power supply is blocked.</b> <ul style="list-style-type: none"> <li>Replace the fuse or check if the circuit breaker has tripped.</li> </ul>
	<b>A power failure has occurred.</b> <ul style="list-style-type: none"> <li>Turn off the appliance when a power failure occurs.</li> <li>When the power is restored, wait 3 minutes, and then turn on the appliance.</li> </ul>
	<b>The voltage is too high or too low.</b> <ul style="list-style-type: none"> <li>Check if the circuit breaker has tripped.</li> </ul>
	<b>The appliance was turned off automatically at a preset time.</b> <ul style="list-style-type: none"> <li>Turn the appliance on.</li> </ul>
	<b>The battery setting in the wireless remote control is incorrect.</b> <ul style="list-style-type: none"> <li>Make sure that the batteries are inserted correctly in your wireless remote control.</li> <li>If the batteries are placed correctly, but the appliance still does not operate, replace the batteries and try again.</li> </ul>
<b>The appliance does not emit cool air.</b>	<b>Air is not circulating properly.</b> <ul style="list-style-type: none"> <li>Make sure that there are no curtains, blinds, or pieces of furniture blocking the front of the appliance.</li> </ul>
	<b>The air filter is dirty.</b> <ul style="list-style-type: none"> <li>Clean the air filter once every 2 weeks.</li> <li>See “<b>Cleaning the Air Filter</b>” for more information.</li> </ul>
	<b>The room temperature is too high.</b> <ul style="list-style-type: none"> <li>In summer, cooling the indoor air fully may take some time. In this case, select the <b>Jet</b> mode to cool the indoor air quickly.</li> </ul>
	<b>Cold air is escaping from the room.</b> <ul style="list-style-type: none"> <li>Make sure that no cold air is escaping through the ventilation points in the room.</li> </ul>

Symptoms	Possible Cause & Solution
<b>The appliance does not emit cool air.</b>	<b>The target temperature is higher than the current temperature.</b> <ul style="list-style-type: none"> <li>Set the target temperature to a level lower than the current temperature.</li> </ul>
	<b>There is a heating source nearby.</b> <ul style="list-style-type: none"> <li>Avoid using heat generators like electric ovens or gas hobs while the air conditioner is in operation.</li> </ul>
	<b>Fan mode is selected.</b> <ul style="list-style-type: none"> <li>During <b>Fan</b> mode, air blows from the appliance without cooling or heating the indoor air.</li> <li>Switch the operating mode to cooling operation.</li> </ul>
	<b>Outside temperature is too high.</b> <ul style="list-style-type: none"> <li>The cooling effect may not be sufficient.</li> </ul>

## Performance

Symptoms	Possible Cause & Solution
<b>The indoor unit is still operating even when the appliance has been turned off.</b>	<b>The Auto Clean+ function is being operated.</b> <ul style="list-style-type: none"> <li>Allow the <b>Auto Clean+</b> function to continue since it reduces any remaining moisture inside the indoor unit. If you do not want this function, you can turn the indoor unit off.</li> </ul>
<b>The air outlet on the indoor unit is discharging mist.</b>	<b>The cooled air from the appliance makes mist.</b> <ul style="list-style-type: none"> <li>When the room temperature decreases, this phenomenon will disappear.</li> </ul>
<b>Water leaks from the outdoor unit.</b>	<b>In the heating operations, condensed water drops from the heat exchanger.</b> <ul style="list-style-type: none"> <li>This requires that a drain hose should be installed under the base pan. Contact the installer.</li> </ul>
<b>There is noise or vibration.</b>	<b>A clicking sound can be heard when the appliance starts or stops due to movement of the reversing valve.</b> <b>Creaking sound: The plastic parts of the indoor unit creak when they shrink or expand due to sudden temperature changes.</b> <b>Flowing or blowing sound: This is the flow of refrigerant through the appliance.</b> <ul style="list-style-type: none"> <li>Noise is normal during or after operation. It is not a sign of malfunction.</li> </ul>
<b>The indoor unit gives off an odour.</b>	<b>Odour (such as cigarette smoke) may be absorbed into the indoor unit and discharged with airflow.</b> <ul style="list-style-type: none"> <li>If the smell does not disappear, you need to wash the filter. If this does not work, contact the service centre to clean your heat exchanger.</li> </ul>

Symptoms	Possible Cause & Solution
The appliance does not emit warm air.	<p><b>When the Heating mode starts, the vane is almost closed, and no air comes out, even though the outdoor unit is operating.</b></p> <ul style="list-style-type: none"> <li>This is normal. Please wait until the appliance has generated enough warm air to blow through the indoor unit.</li> </ul>
	<p><b>The outdoor unit is in Defrosting mode.</b></p> <ul style="list-style-type: none"> <li>In <b>Heating</b> mode, ice and frost is built up on the coils when the outside temperature falls. The <b>Defrosting</b> mode reduces a layer of frost on the coil, and it should finish in approximately 15 minutes.</li> </ul>
	<p><b>Outside temperature is too low.</b></p> <ul style="list-style-type: none"> <li>The heating effect may not be sufficient.</li> <li>The appliance must be preheated if the outside temperature has been below 0 °C (32 °F) and the appliance is either not connected to the power supply or the power supply is turned off for an extended period. <ul style="list-style-type: none"> <li>For best performance, ensure that appliances remain powered when the outside temperature is below 0 °C (32 °F).</li> <li>If the appliance is left unpowered for an extended period of time when the outside temperature is below 0 °C (32 °F), power it and wait at least 2 hours before operating it. If you supply power and operate the heating without waiting, the appliance will preheat for about an hour before you can operate the heating. However, doing so is not recommended as it may cause a malfunction.</li> </ul> </li> </ul>

## Wi-Fi

Symptoms	Possible Cause & Solution
Your home appliance and smartphone are not connected to the Wi-Fi network.	<p><b>The password for the Wi-Fi that you are trying to connect to is incorrect.</b></p> <ul style="list-style-type: none"> <li>Find the Wi-Fi network connected to your smartphone and remove it, then register your appliance on <b>LG ThinQ</b>.</li> </ul>
	<p><b>Mobile data for your smartphone is turned on.</b></p> <ul style="list-style-type: none"> <li>Turn off the <b>Mobile data</b> of your smartphone and register the appliance using the Wi-Fi network.</li> </ul>
	<p><b>The wireless network name (SSID) is set incorrectly.</b></p> <ul style="list-style-type: none"> <li>The wireless network name (SSID) should be a combination of English letters and numbers. (Do not use special characters.)</li> </ul>
	<p><b>The router frequency is not 2.4 GHz.</b></p> <ul style="list-style-type: none"> <li>Only a 2.4 GHz router frequency is supported. Set the wireless router to 2.4 GHz and connect the appliance to the wireless router. To check the router frequency, check with your Internet service provider or the router manufacturer.</li> </ul>

Symptoms	Possible Cause & Solution
<b>Your home appliance and smartphone are not connected to the Wi-Fi network.</b>	<b>The distance between the appliance and the router is too far.</b> <ul style="list-style-type: none"><li>• If the distance between the appliance and the router is too far, the signal may be weak and the connection may not be configured correctly. Move the location of the router so that it is closer to the appliance.</li></ul>

