

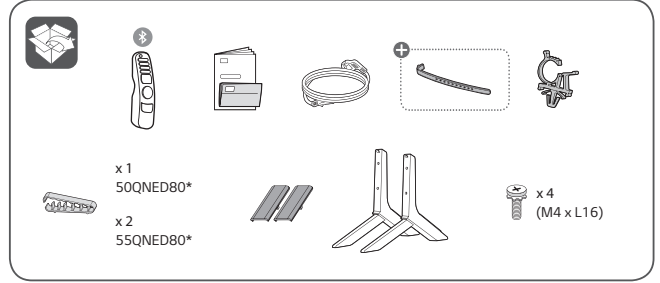

50QNE80SRA 55QNE80SRA

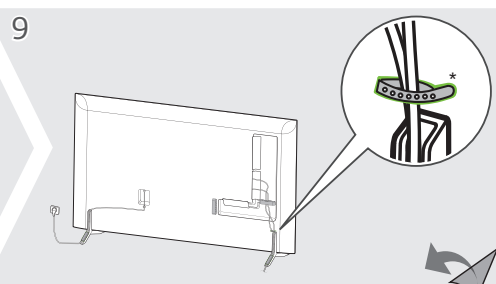

+ Dependendo do modelo

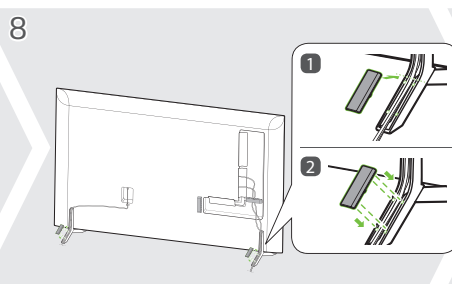
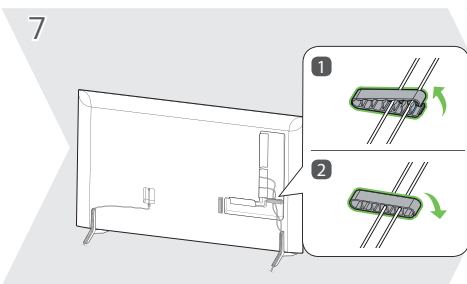
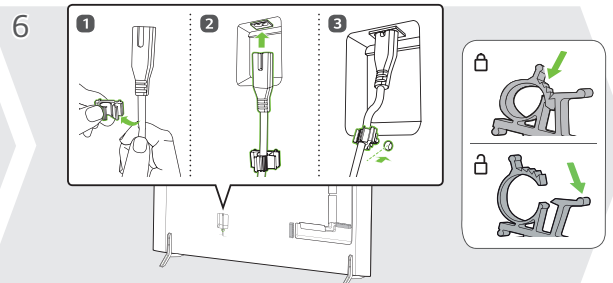
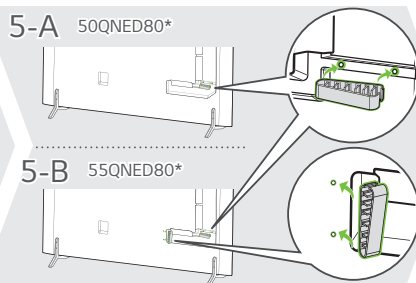
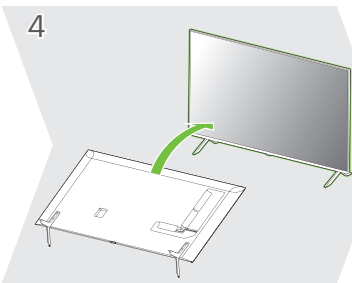
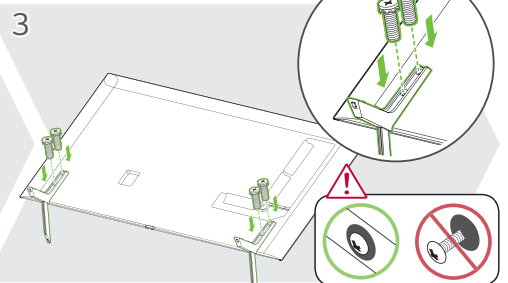
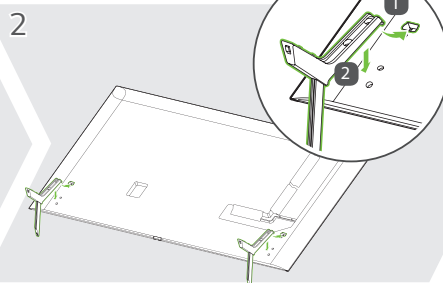
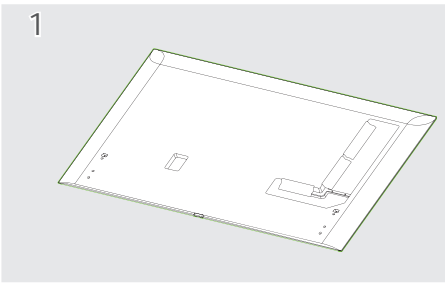
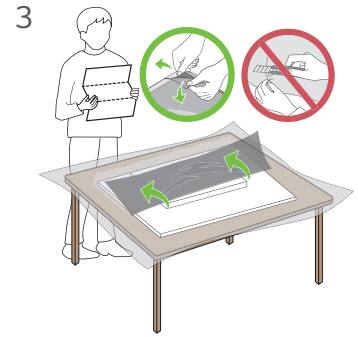
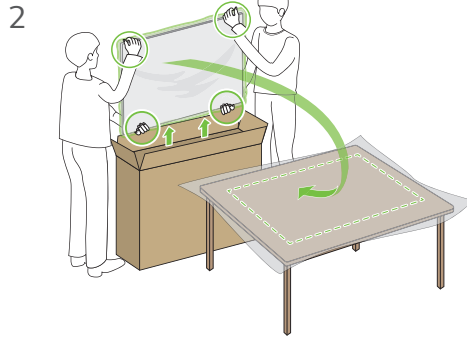
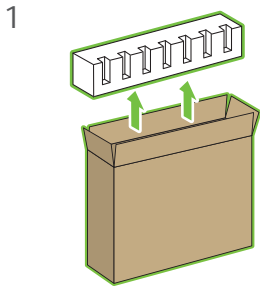

*Dependendo do modelo

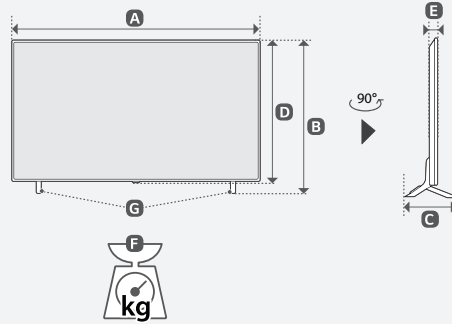
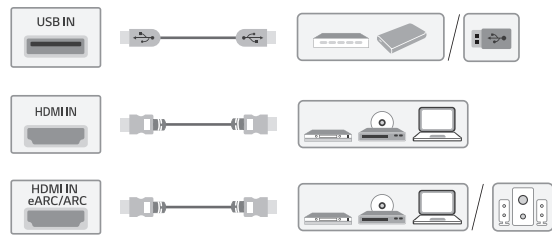
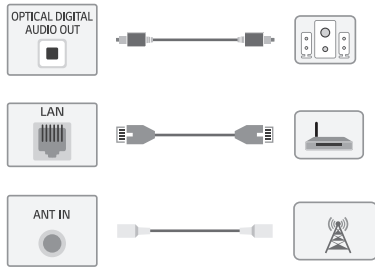

MODELOS	A	B	C	D	E	F	F - G	Consumo de potência
50QNED80SRA	1 123 mm (44.2) pol.	720 mm (28.3) pol.	257 mm (10.1) pol.	652 mm (25.6) pol.	29.7 mm (1.1) pol.	13.4 kg (29.5) lbs	13.0 kg (28.6) lbs	135 W
55QNED80SRA	1 236 mm (48.6) pol.	783 mm (30.8) pol.	257 mm (10.1) pol.	716 mm (28.1) pol.	29.7 mm (1.1) pol.	15.3 kg (33.7) lbs	14.9 kg (32.8) lbs	165 W

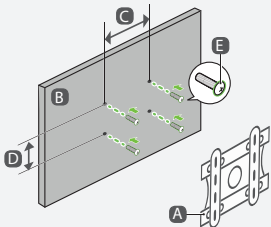

A	B	C x D	E
LSW240B MSW240	50QNED80*	200 x 200 mm (7.8 x 7.8) pol.	M6
OLW480B MSW240	55QNED80*	300 x 300 mm (11.8 x 11.8) pol.	M6

A / E Não incluso no produto

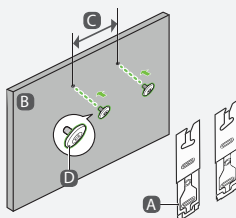
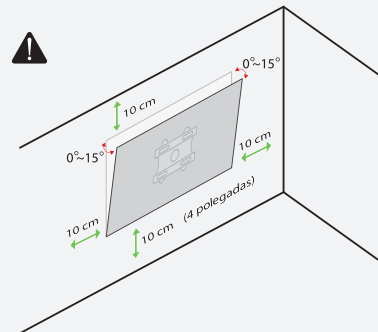

A	B	C	D
WB21LMB	50QNED80*	200 mm (7.8) pol.	M6
WB21LMB	55QNED80*	300 mm (11.8) pol.	M6

A / D Não incluso no produto

PRODUZIDO NO POLO INDUSTRIAL DE MANAUS
 CONHEÇA A AMAZÔNIA
LG Electronics do Brasil Ltda.
 CNPJ: 01.168.372/0008-21
 Rua Javari, nº 1004, Distrito Industrial, CEP 69075-110, Manaus/AM, Indústria Brasileira