



**LG**

Life's Good

# OWNER'S MANUAL PLASMA TV

Please read this manual carefully before operating your set and retain it for future reference.

42PA4500  
50PA4500  
50PA4510

42PA4900  
50PA4900

50PA5500  
60PA5500

50PA6500  
60PA6500  
60PA6550

42PA450C  
50PA450C  
50PA550C  
60PA550C

## LICENSES

Supported licenses may differ by model. For more information about licenses, visit [www.lg.com](http://www.lg.com).



Manufactured under license from Dolby Laboratories. "Dolby" and the double-D symbol are trademarks of Dolby Laboratories.



HDMI, the HDMI logo and High-Definition Multimedia Interface are trademarks or registered trademarks of HDMI Licensing LLC.



ABOUT DIVX VIDEO: DivX® is a digital video format created by DivX, LLC, a subsidiary of Rovi Corporation. This is an official DivX Certified® device that plays DivX video. Visit [divx.com](http://divx.com) for more information and software tools to convert your files into DivX video.

ABOUT DIVX VIDEO-ON-DEMAND: This DivX Certified® device must be registered in order to play purchased DivX Video-on-Demand (VOD) movies. To obtain your registration code, locate the DivX VOD section in your device setup menu. Go to [vod.divx.com](http://vod.divx.com) for more information on how to complete your registration.

"DivX Certified® to play DivX® video up to HD 1080p, including premium content."

"DivX®, DivX Certified® and associated logos are trademarks of Rovi Corporation or its subsidiaries and are used under license."

"Covered by one or more of the following U.S. patents:  
7,295,673; 7,460,668; 7,515,710; 7,519,274"

## OPEN SOURCE SOFTWARE NOTICE

To obtain the source code under GPL, LGPL, MPL and other open source licenses, that is contained in this product, please visit <http://opensource.lge.com>.

In addition to the source code, all referred license terms, warranty disclaimers and copyright notices are available for download.

LG Electronics will also provide open source code to you on CD-ROM for a charge covering the cost of performing such distribution (such as the cost of media, shipping and handling) upon email request to [opensource@lge.com](mailto:opensource@lge.com). This offer is valid for three (3) years from the date on which you purchased the product.

# IMPORTANT SAFETY INSTRUCTIONS

Always comply with the following precautions to avoid dangerous situations and ensure peak performance of your product.





**WARNING / CAUTION**

**RISK OF ELECTRIC SHOCK  
DO NOT OPEN**



TO REDUCE THE RISK OF ELECTRIC SHOCK DO NOT REMOVE COVER (OR BACK). NO USER SERVICEABLE PARTS INSIDE. REFER TO QUALIFIED SERVICE PERSONNEL.

 The lightning flash with arrowhead symbol, within an equilateral triangle, is intended to alert the user to the presence of uninsulated "dangerous voltage" within the product's enclosure that may be of sufficient magnitude to constitute a risk of electric shock to persons.

 The exclamation point within an equilateral triangle is intended to alert the user to the presence of important operating and maintenance (servicing) instructions in the literature accompanying the appliance.

**WARNING/CAUTION**

- TO REDUCE THE RISK OF FIRE AND ELECTRIC SHOCK, DO NOT EXPOSE THIS PRODUCT TO RAIN OR MOISTURE.

Read these instructions.  
Keep these instructions.  
Heed all warnings.  
Follow all instructions.



- Do not use this apparatus near water.



- Clean only with a dry cloth.



- Do not block any ventilation openings. Install in accordance with the manufacturer's instructions.

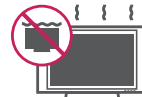

- Do not install near any heat sources such as radiators, heat registers, stoves, or other apparatus (including amplifiers) that produce heat.



- Do not defeat the safety purpose of the polarized or grounding-type plug. A polarized plug has two blades with one wider than the other. A grounding type plug has two blades and a third grounding prong. The wide blade or the third prong are provided for your safety. If the provided plug does not fit into your outlet, consult an electrician for replacement of the obsolete outlet (Can differ by country).

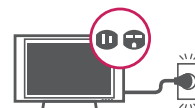

- Protect the power cord from being walked on or pinched particularly at plugs, convenience receptacles, and the point where they exit from the apparatus.



- Only use attachments/accessories specified by the manufacturer.



- Use only with a cart, stand, tripod, bracket, or table specified by the manufacturer, or sold with the apparatus. When a cart is used, use caution when moving the cart/apparatus combination to avoid injury from tip-over.



- Unplug this apparatus during lightning storms or when unused for long periods of time.

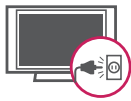

- Refer all servicing to qualified service personnel. Servicing is required when the apparatus has been damaged in any way, such as power-supply cord or plug is damaged, liquid has been spilled or objects have fallen into the apparatus, the apparatus has been exposed to rain or moisture, does not operate normally, or has been dropped.



- Do not stick metal objects or any other conductive material into the power cord. Do not touch the end of the power cord while it is plugged in.



- Keep the packing anti-moisture material or vinyl packing out of the reach of children. Anti-moisture material is harmful if swallowed. If swallowed by mistake, force the patient to vomit and visit the nearest hospital. Additionally, vinyl packing can cause suffocation. Keep it out of the reach of children.

- CAUTION concerning the Power Cord (Can differ by country):

It is recommended that appliances be placed upon a dedicated circuit; that is, a single outlet circuit which powers only that appliance and has no additional outlets or branch circuits. Check the specification page of this owner's manual to be certain. Do not connect too many appliances to the same AC power outlet as this could result in fire or electric shock. Do not overload wall outlets. Overloaded wall outlets, loose or damaged wall outlets, extension cords, frayed power cords, or damaged or cracked wire insulation are dangerous. Any of these conditions could result in electric shock or fire. Periodically examine the cord of your appliance, and if its appearance indicates damage or deterioration, unplug it, discontinue use of the appliance, and have the cord replaced with an exact replacement part by an authorized service. Protect the power cord from physical or mechanical abuse, such as being twisted, kinked, pinched, closed in a door, or walked upon. Pay particular attention to plugs, wall outlets, and the point where the cord exits the appliance. Do not move the TV with the power cord plugged in. Do not use a damaged or loose power cord. Be sure do grasp the plug when unplugging the power cord. Do not pull on the power cord to unplug the TV.

- **Warning** - To reduce the risk of fire or electrical shock, do not expose this product to rain, moisture or other liquids. Do not touch the TV with wet hands. Do not install this product near flammable objects such as gasoline or candles, or expose the TV to direct air conditioning.



- Do not expose to dripping or splashing and do not place objects filled with liquids, such as vases, cups, etc. on or over the apparatus (e.g. on shelves above the unit).



**Grounding**

(Except for devices which are not grounded.) Ensure that you connect the earth ground wire to prevent possible electric shock (i.e. a TV with a three-prong grounded AC plug must be connected to a three-prong grounded AC outlet). If grounding methods are not possible, have a qualified electrician install a separate circuit breaker. Do not try to ground the unit by connecting it to telephone wires, lightening rods, or gas pipes.

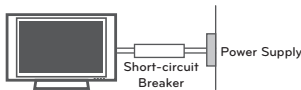

**DISCONNECTING DEVICE FROM THE MAIN POWER**

Mains plug is the disconnecting device. The plug must remain readily operable.

- As long as this unit is connected to the AC wall outlet, it is not disconnected from the AC power source even if the unit is turned off.
- Do not attempt to modify this product in any way without written authorization from LG Electronics. Unauthorized modification could void the user's authority to operate this product.
- **ANTENNAS Outdoor antenna grounding** (Can differ by country):

If an outdoor antenna is installed, follow the precautions below. An outdoor antenna system should not be located in the vicinity of overhead power lines or other electric light or power circuits, or where it can come in contact with such power lines or circuits as death or serious injury can occur. Be sure the antenna system is grounded so as to provide some protection against voltage surges and built-up static charges. Section 810 of the National Electrical Code (NEC) in the U.S.A. provides information with respect to proper grounding of the mast and supporting structure, grounding of the lead-in wire to an antenna discharge unit, size of grounding conductors, location of antenna discharge unit, connection to grounding electrodes and requirements for the grounding electrode.

**Antenna grounding according to the National Electrical Code, ANSI/NFPA 70**

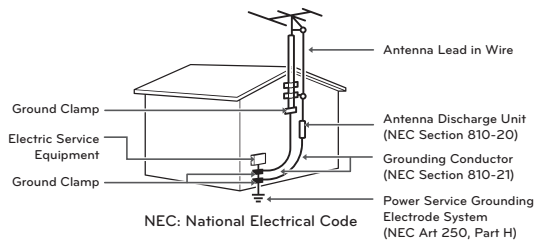

- **Cleaning**

When cleaning, unplug the power cord and wipe gently with a soft cloth to prevent scratching. Do not spray water or other liquids directly on the TV as electric shock may occur. Do not clean with chemicals such as alcohol, thinners or benzene.

- **Moving**

Make sure the product is turned off, unplugged and all cables have been removed. It may take 2 or more people to carry larger TVs. Do not press or put stress on the front panel of the TV.

- **Ventilation**

Install your TV where there is proper ventilation. Do not install in a confined space such as a bookcase. Do not cover the product with cloth or other materials while plugged. Do not install in excessively dusty places.

- If you smell smoke or other odors coming from the TV, unplug the power cord and contact an authorized service center.
- Do not press strongly upon the panel with a hand or a sharp object such as a nail, pencil or pen, or make a scratch on it.
- Keep the product away from direct sunlight.



- Never touch this apparatus or antenna during a thunder or lightning storm.
- When mounting a TV on the wall, make sure not to install the TV by hanging the power and signal cables on the back of the TV.
- Do not allow an impact shock or any objects to fall into the product, and do not drop anything onto the screen.

- **Dot Defect**

The Plasma or LCD panel is a high technology product with resolution of two million to six million pixels. In a very few cases, you could see fine dots on the screen while you're viewing the TV. Those dots are deactivated pixels and do not affect the performance and reliability of the TV.

- **Generated Sound**

"Cracking" noise: A cracking noise that occurs when watching or turning off the TV is generated by plastic thermal contraction due to temperature and humidity. This noise is common for products where thermal deformation is required.

Electrical circuit humming/panel buzzing: A low level noise is generated from a high-speed switching circuit, which supplies a large amount of current to operate a product. It varies depending on the product.

This generated sound does not affect the performance and reliability of the product.

- Take care not to touch the ventilation openings. When watching the TV for a long period, the ventilation openings may become hot. This does not affect the performance of the product or cause defects in the product.

#### Preventing "Image burn" or "Burn-in" on your TV screen

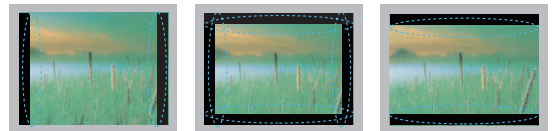

- If a fixed image displays on the TV screen for a long period of time, it will be imprinted and become a permanent disfigurement on the screen. This is "image burn" or "burn-in" and not covered by the warranty.
- If the aspect ratio of the TV is set to 4:3 for a long period of time, image burn may occur on the letterboxed area of the screen.
- Avoid displaying a fixed image on the TV screen for a long period of time (2 or more hours for LCD, 1 or more hours for the Plasma TV) to prevent image burn.

## For USA and Canada

### FCC NOTICE

This equipment has been tested and found to comply with the limits for a Class B digital device, pursuant to Part 15 of the FCC Rules. These limits are designed to provide reasonable protection against harmful interference in a residential installation.

This equipment generates, uses and can radiate radio frequency energy and, if not installed and used in accordance with the instructions, may cause harmful interference to radio communications. However, there is no guarantee that interference will not occur in a particular installation. If this equipment does cause harmful interference to radio or television reception, which can be determined by turning the equipment off and on, the user is encouraged to try to correct the interference by one or more of the following measures:

- Reorient or relocate the receiving antenna.
- Increase the separation between the equipment and the receiver.
- Connect the equipment to an outlet on a circuit different from that to which the receiver is connected.
- Consult the dealer or an experienced radio/TV technician for help.

This device complies with part 15 of the FCC Rules. Operation is subject to the following two conditions: (1) this device may not cause harmful interference and (2) this device must accept any interference received, including interference that may cause undesired operation of the device.

Any changes or modifications in construction of this device which are not expressly approved by the party responsible for compliance could void the user's authority to operate the equipment.

### NOTE TO CABLE/TV INSTALLER

This reminder is provided to call the CATV system installer's attention to Article 820-40 of the National Electric Code (U.S.A.). The code provides guidelines for proper grounding and, in particular, specifies that the cable ground shall be connected to the grounding system of the building, as close to the point of the cable entry as practical.

# TABLE OF CONTENTS

## 2 LICENSES

---

## 2 OPEN SOURCE SOFTWARE NOTICE

---

## 3 IMPORTANT SAFETY INSTRUCTIONS

---

## 8 TABLE OF CONTENTS

---

## 9 INSTALLATION PROCEDURE

---

### 9 ASSEMBLING AND PREPARING

---

- 9 Unpacking
- 11 Optional Extras
- 13 Parts and buttons
- 14 Lifting and moving the TV
- 15 Setting up the TV
  - 15 - Attaching the stand
  - 16 - Attaching the protection cover
  - 16 - Tidying cables
  - 17 - Mounting on a table
  - 18 - Mounting on a wall

### 19 MAKING CONNECTIONS

---

- 19 Connecting to an antenna or cable
- 20 Connecting to a HD receiver, DVD, or VCR player
  - 20 - HDMI Connection
  - 21 - DVI to HDMI Connection
  - 22 - Component Connection
  - 23 - Composite Connection
- 24 Connecting to a PC
  - 24 - HDMI Connection, DVI to HDMI Connection or RGB Connection
- 26 Connecting to an Audio System
  - 26 - Digital Optical Audio Connection
- 27 Connecting to a USB

## 28 REMOTE CONTROL

---

## 32 WATCHING TV

---

- 32 Turning the TV on for the first time

## 33 USING THE USER GUIDE

---

## 34 TROUBLESHOOTING

---

## 35 SPECIFICATIONS

---

## 38 MAINTENANCE

---

- 38 Cleaning Your TV
  - 38 - Screen, frame, cabinet and stand
  - 38 - Power cord



### NOTE

- Image shown may differ from your TV.
- Your TV's OSD (On Screen Display) may differ slightly from that shown in this manual.
- The available menus and options may differ from the input source or product model that you are using.
- New features may be added to this TV in the future.

# INSTALLATION PROCEDURE

- 1 Open the package and make sure all the accessories are included.
- 2 Attach the stand to the TV set.
- 3 Connect an external device to the TV set.

## ASSEMBLING AND PREPARING

### Unpacking

Check your product box for the following items. If there are any missing accessories, contact the local dealer where you purchased your product. The illustrations in this manual may differ from the actual product and item.

For PA4500, PA4510, PA5500, PA6500, PA6550, PA450C, PA550C series

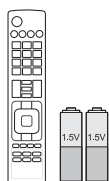

**Remote control,  
Batteries (AAA)**  
(See p.28, p.30)

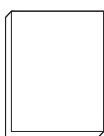

**Owner's manual**

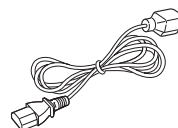

**Power Cord**

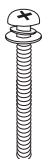

**Stand Screws**  
4 EA, M4 x 30  
(See p.15, p.16)



**Stand Screws**  
3 EA, M5 x 16  
(See p.15)



**Power Cord holder**  
(See p.16)

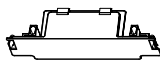

**Protection cover**  
(See p.16)

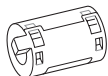

**Ferrite core**  
(Depending on model)  
(See p.12)

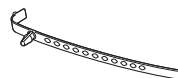

**Cable holder**  
(See p.16)



**Polishing cloth**  
(Depending on model)  
Use this to remove dust from  
the cabinet.



**Stand Body**  
(See p.15)

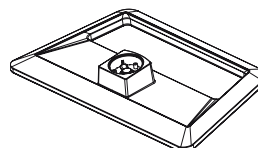

**Stand Base**  
(See p.15)

For PA4900 series

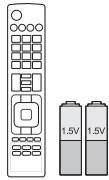

**Remote control,  
Batteries (AAA)**  
(See p.30)

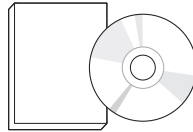

**Owner's manual,  
CD manual (Included  
Pentouch Software)**

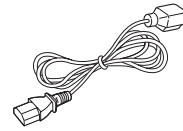

**Power Cord**

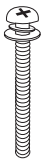

**Stand Screws**  
4 EA, M4 x 30  
(See p.15, p.16)



**Stand Screws**  
3 EA, M5 x 16  
(See p.15)



**Polishing cloth**  
(Depending on model)  
Use this to remove dust  
from the cabinet.

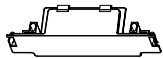

**Protection cover**  
(See p.16)

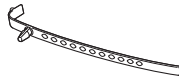

**Cable holder**  
(See p.16)



**Power Cord holder**  
(See p.16)

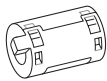

**Ferrite core**  
(Depending on model)  
(See p.12)

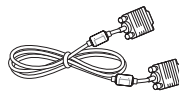

**D-sub 15 pin signal cable**

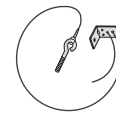

**Eye-bolt & Wall bracket**  
2 EA  
(See p.17)



**Stand Body**  
(See p.15)

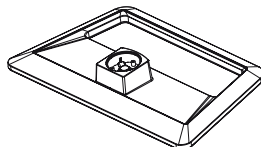

**Stand Base**  
(See p.15)



**Touch Pen**  
The number of touch pen  
may differ depending on the  
model.



**Tip**  
The number of tip may differ depending on the model.



**Touch Pen Dongle**

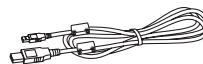

**Charging Cable**



**Cradle**

## Optional Extras

Optional extras can be changed or modified for quality improvement without any notification. Contact your dealer to buy these items. These devices only work with certain models.



### AN-TP300

Touch Pen, Cradle

The number of touch pen and tip may differ depending on the model.

Compatibility	PA4500	PA4510	PA4900	PA5500	PA6500	PA6550	PA450C	PA550C
AN-TP300 Touch Pen, Cradle			●					



### CAUTION

- Do not use any unapproved items to ensure the safety and product life span.
- Any damages or injuries by using unapproved items are not covered by the warranty.
- In case of some model, the thin film on screen is a part of TV, So don't take it off.

**!** NOTE

- The items supplied with your product may vary depending on the model.
- Product specifications or contents of this manual may be changed without prior notice due to upgrade of product functions.
- How to use the ferrite core

1 Use the ferrite core to reduce the electromagnetic interference in the PC audio cable.  
Wind the PC audio cable on the ferrite core thrice. Place the ferrite core close to the TV.

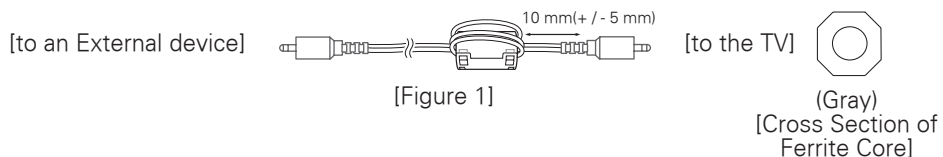

2 Use the ferrite core to reduce the electromagnetic interference in the power cable.  
Wind the power cable on the ferrite core once. Place the ferrite core close to the TV and a wall plug.

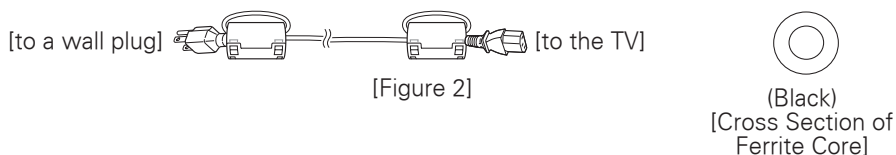

3 Use the ferrite core to reduce the electromagnetic interference in the component cable.  
Wind the component cable on the ferrite core once. Place the ferrite core close to the TV.

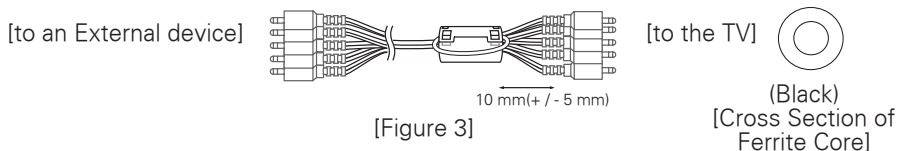

4 Use the ferrite core to reduce the electromagnetic interference in the component cable.  
Place the ferrite core close to the TV.

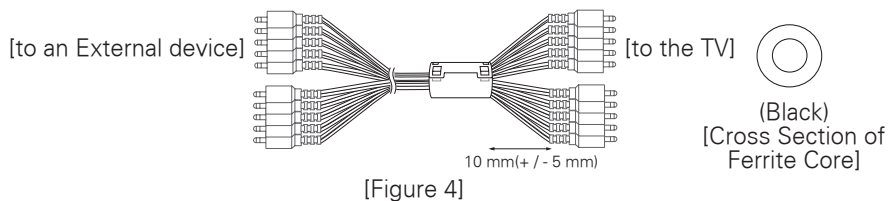

- If there is one ferrite core, follow as shown in Figure 1.
- If there are three ferrite cores, follow as shown in Figures 1 and 2.
- If there are four ferrite cores, follow as shown in Figures 1, 2, 3 and 4.

## Parts and buttons

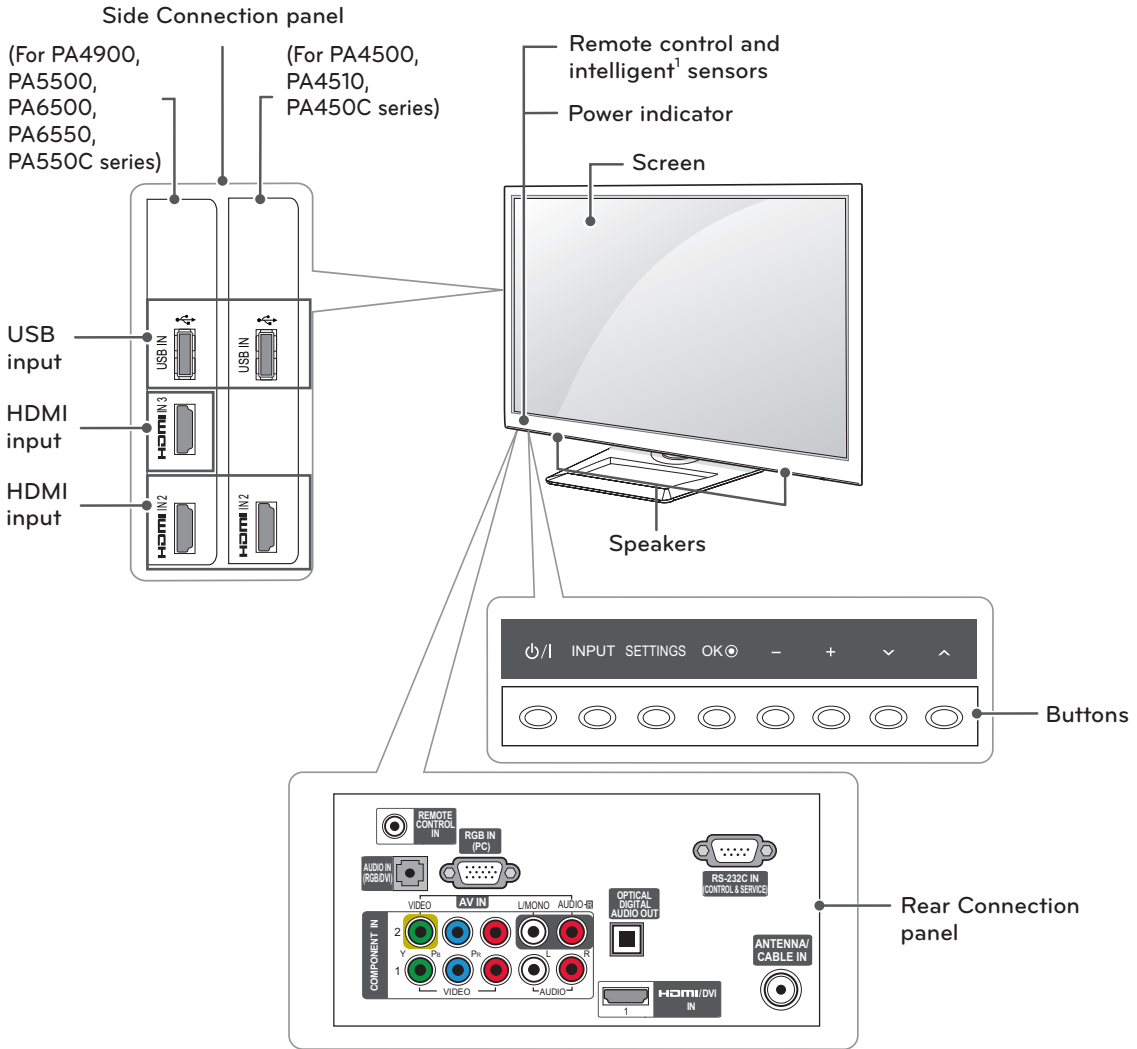

ENGLISH

Button	Description
⏻/⏻	Turns the power on or off.
INPUT	Changes the input source.
SETTINGS	Accesses the main menus, or saves your input and exits the menus.
OK	Selects the highlighted menu option or confirms an input.
- +	Adjusts the volume level.
⏮ ⏭	Scrolls through the saved channels.

<sup>1</sup> Adjusts the image quality and brightness based on the surrounding environment.

## Lifting and moving the TV

When moving or lifting the TV, read the following to prevent the TV from being scratched or damaged and for safe transportation regardless of its type and size.



### CAUTION

- Avoid touching the screen at all times, as this may result in damage to the screen.
- It is recommended to move the TV in the box or packing material that the TV originally came in.
- Before moving or lifting the TV, disconnect the power cord and all cables.
- When holding the TV, the screen should face away from you to avoid damage.



- Hold the top and bottom of the TV frame firmly. Make sure not to hold the transparent part, speaker, or speaker grill area.

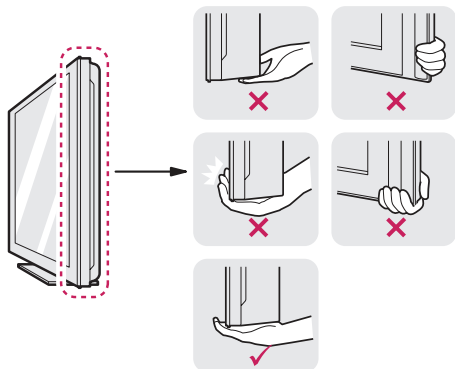

- When transporting a large TV, there should be at least 2 people.
- When transporting the TV by hand, hold the TV as shown in the following illustration.

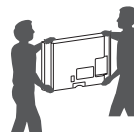

- When transporting the TV, do not expose the TV to jolts or excessive vibration.
- When transporting the TV, keep the TV upright, never turn the TV on its side or tilt towards the left or right.

## Setting up the TV

Put your TV on a pedestal stand and mount the TV on a table or wall.

### Attaching the stand

If you are not mounting the TV to a wall, use the following instructions to attach the stand.

1

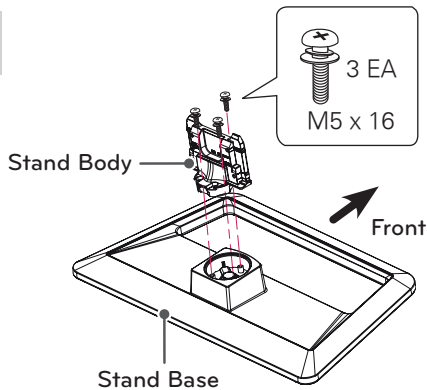

2

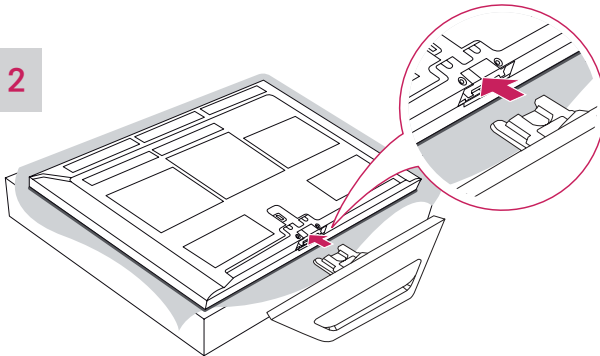

#### ! CAUTION

- When attaching the stand to the TV set, place the screen facing down on a cushioned table or flat surface to protect the screen from scratches.

3

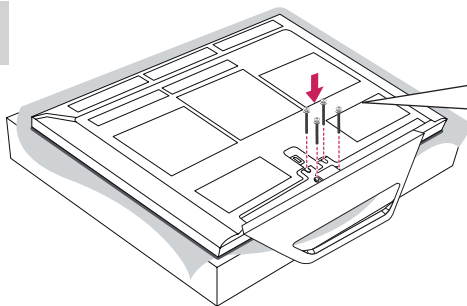

4 EA  
M4 x 30

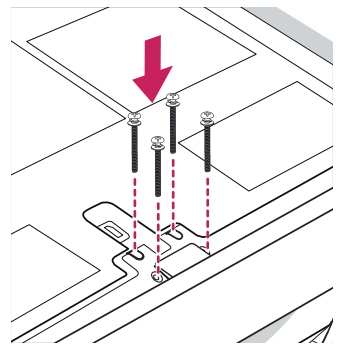

#### ! CAUTION

- Make sure that the screws are fastened completely. (If they are not fastened securely enough, the TV may tilt forward after being installed.)
- Do not fasten the screws with too much force; otherwise they may be worn out and get loosened.

## Attaching the protection cover

- 1 Remove the stand before installing the TV on a wall mount by performing the stand attachment in reverse. After removing the stand, push the supplied protection cover into the opening at the bottom of the TV until it locks in place. This will protect the opening from accumulating dust and dirt.

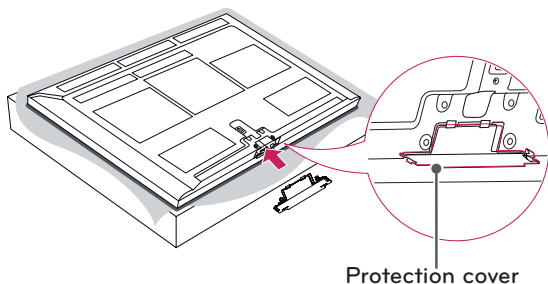

- 2 Secure the TV and the protection cover with the 2 screws.

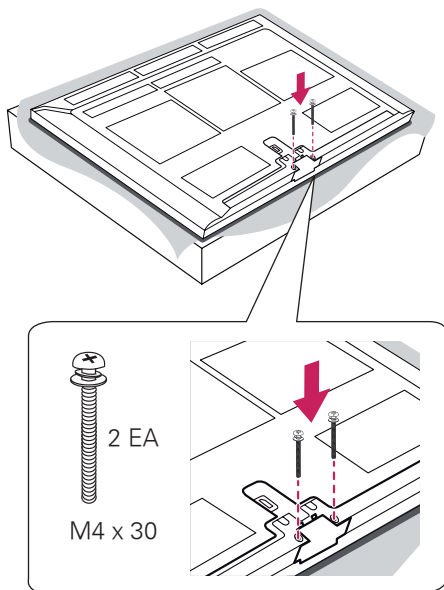

### ! CAUTION

- Make sure that the screws are fastened completely. (If they are not fastened securely enough, the TV may tilt forward after being installed.)
- Do not fasten the screws with too much force; otherwise they may be worn out and get loosened.

## Tidying cables

- 1 Install the power cord holder and power cord. It will help prevent the power cable from being removed by accident.

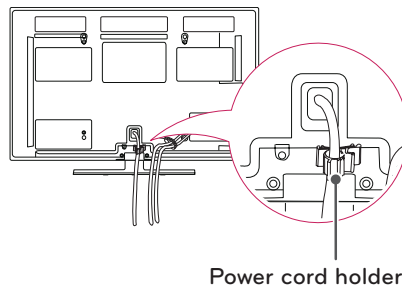

- 2 Gather and bind the cables with the cable holder.

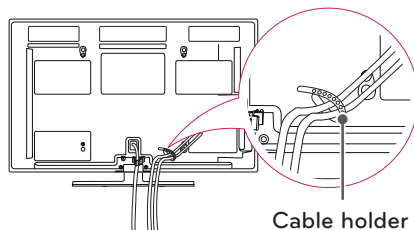

### ! CAUTION

- Do not move the TV by holding the cable holder and power cord holder, as the cable holders may break, and injuries and damage to the TV may occur.

## Mounting on a table

- Lift and tilt the TV into its upright position on a table.
  - Leave a 10 cm (4 inch) (minimum) space from the wall for proper ventilation.

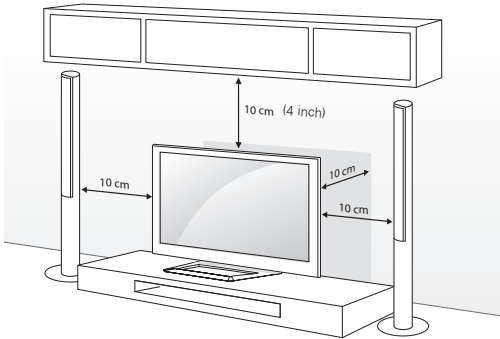

- Connect the power cord to a wall outlet.



### CAUTION

- Do not place the TV near or on sources of heat, as this may result in fire or other damage.

### Adjusting the angle of the TV to suit view

Swivel 20 degrees to the left or right and adjust the angle of the TV to suit your view.

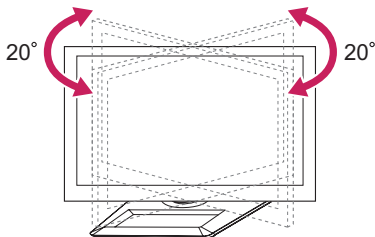

### CAUTION

- When adjusting the angle of the TV, watch out for your fingers.
  - Personal injury may occur if hands or fingers are pinched. If the product is tilted too much, it may fall, causing damage or injury.

### Securing the TV to a wall (For PA4900 series)

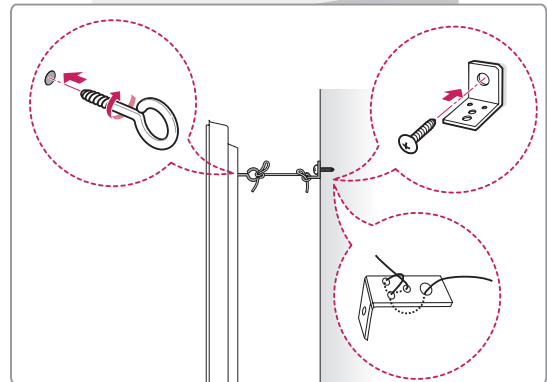
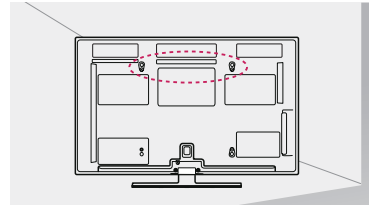

- Insert and tighten the eye-bolts on the back of the TV.
  - If there are bolts inserted at the eye-bolts position, remove the bolts first.
- Mount the wall brackets with the bolts to the wall.
  - Match the location of the wall bracket and the eye-bolts on the rear of the TV.
- Connect the eye-bolts and wall brackets tightly with a sturdy rope.
  - Make sure to keep the rope horizontal with the flat surface.



### CAUTION

- Make sure that children do not climb on or hang on the TV.



### NOTE

- Use a platform or cabinet that is strong and large enough to support the TV securely.

## Mounting on a wall

Attach an optional wall mount bracket at the rear of the TV carefully and install the wall mount bracket on a solid wall perpendicular to the floor. When you attach the TV to other building materials, please contact qualified personnel. LG recommends that wall mounting be performed by a qualified professional installer.

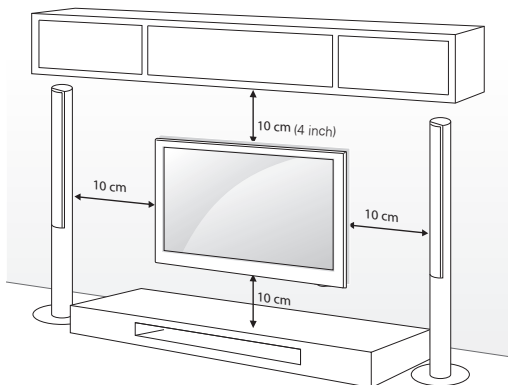

Make sure to use screws and wall mount bracket that meet the VESA standard. Standard dimensions for the wall mount kits are described in the following table.

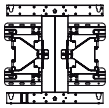
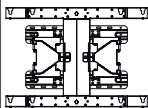
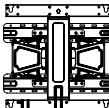
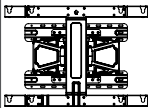
<b>Model</b>	42/50PA4500, 50PA4510, 42/50PA4900, 50PA5500, 50PA6500, 42/50PA450C, 50PA550C	60PA5500, 60PA6500, 60PA6550, 60PA550C
<b>VESA</b>	400 x 400	600 x 400
<b>Standard screw</b>	M6	M8
<b>Number of screws</b>	4	4
<b>Wall mount bracket (optional)</b>	PSW400B 	PSW600B 
	PSW420BX 	PSW620BX 

### ! CAUTION

- Disconnect the power first, and then move or install the TV. Otherwise electric shock may occur.
- If you install the TV on a ceiling or slanted wall, it may fall and result in severe injury. Use an authorized LG wall mount and contact the local dealer or qualified personnel.
- Do not over tighten the screws as this may cause damage to the TV and void your warranty.
- Use the screws and wall mounts that meet the VESA standard. Any damages or injuries by misuse or using an improper accessory are not covered by the warranty.

### ! NOTE

- Use the screws that are listed on the VESA standard screw specifications.
- The wall mount kit includes an installation manual and necessary parts.
- The wall mount bracket is optional. You can obtain additional accessories from your local dealer.
- The length of screws may differ depending on the wall mount. Make sure to use the proper length.
- For more information, refer to the manual supplied with the wall mount.

# MAKING CONNECTIONS

Connect various external devices to the TV and switch input modes to select an external device. For more information on external device's connection, refer to the manual provided with each device. Available external devices are: HD receivers, DVD players, VCRs, audio systems, USB storage devices, PC, gaming devices, and other external devices.



## NOTE

- If you record a TV program on a DVD recorder or VCR, make sure to connect the TV signal input cable to the TV through a DVD recorder or VCR. For more information on recording, refer to the manual provided with the connected device.
- The external device connection may differ from the model.
- Connect external devices to the TV regardless of the order of the TV port.
- If you connect a gaming device to the TV, use the cable supplied with the gaming device.
- Refer to the external equipment's manual for operating instructions.

## Connecting to an antenna or cable

Connect an antenna, cable, or cable box to watch TV while referring to the following. The illustrations may differ from the actual items and a RF cable is optional.

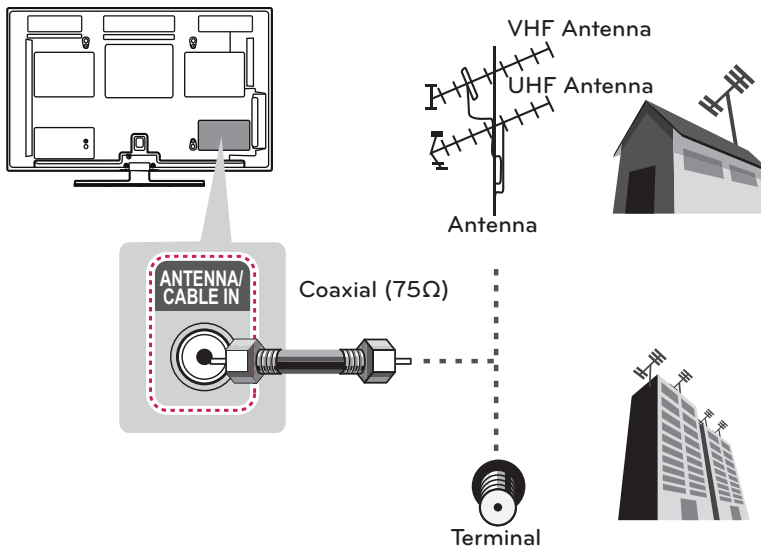

## CAUTION

- Make sure not to bend the copper wire of the RF cable.

Copper wire

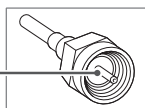

- Complete all connections between devices, and then connect the power cord to the power outlet to prevent damage to your TV.



## NOTE

- Use a signal splitter to use more than 2 TVs.
- Visit <http://lgknowledgebase.com> for more information about the antenna and cable connection. Search for antenna.

- This part of MAKING CONNECTIONS mainly uses picture for PA6500 series.

## Connecting to a HD receiver, DVD, or VCR player

Connect a HD receiver, DVD, or VCR player to the TV and select an appropriate input mode.

### HDMI Connection

**HDMI is the best way to connect a device.**

Transmits the digital video and audio signals from an external device to the TV. Connect the external device and the TV with the HDMI cable as shown in the following illustration.

#### ! NOTE

- Use the latest High Speed HDMI™ Cable with CEC (Customer Electronics Control) function.
- High Speed HDMI™ Cables are tested to carry an HD signal up to 1080p and higher.

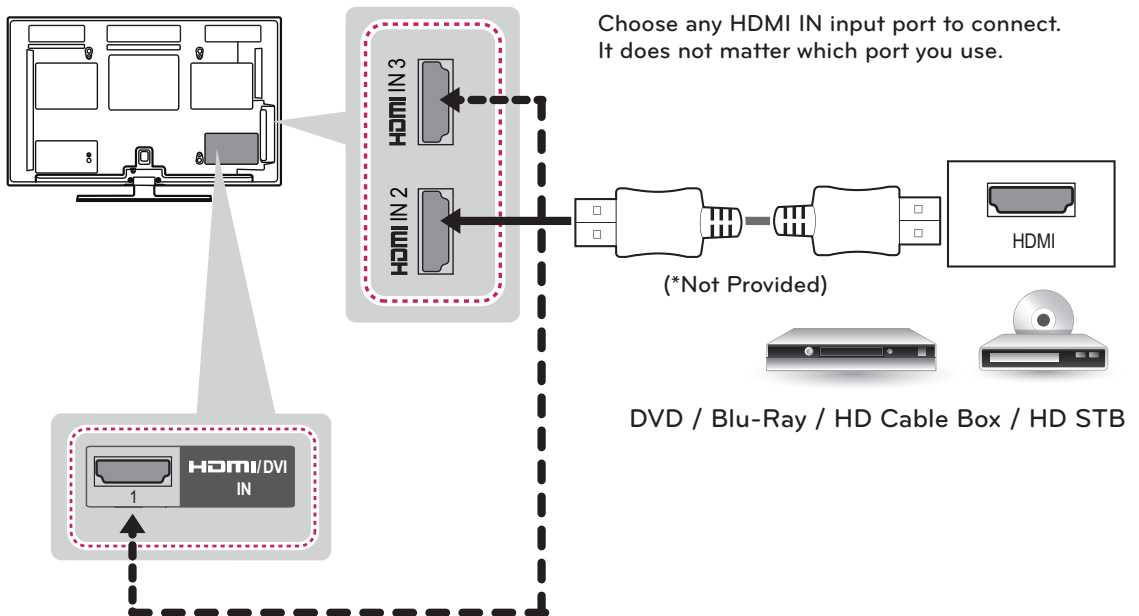

## DVI to HDMI Connection

Transmits the digital video signal from an external device to the TV. Connect the external device and the TV with the DVI-HDMI cable as shown in the following illustration. To transmit an audio signal, connect an audio cable.

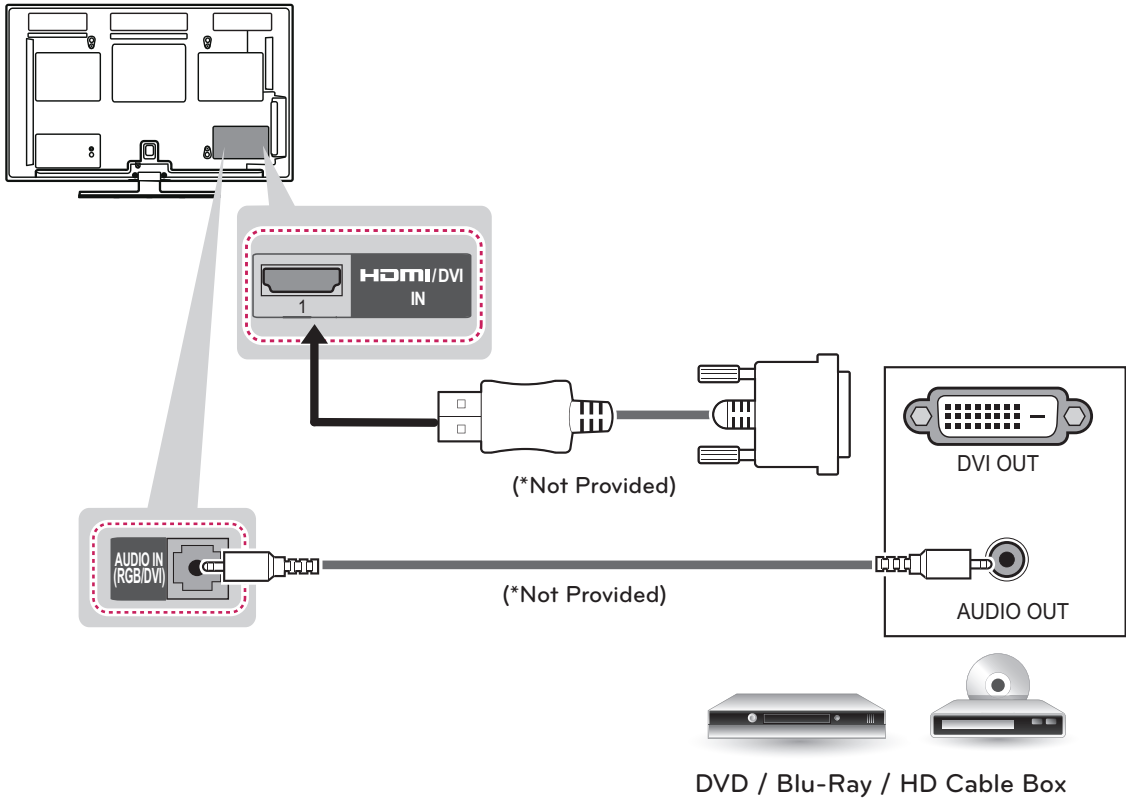

## Component Connection

Transmits the analog video and audio signals from an external device to the TV. Connect the external device and the TV with the component cable as shown in the following illustration.



**NOTE**

- If cables are installed incorrectly, it could cause the image to display in black and white or with distorted color.
- **Check to ensure the cables are matched with the corresponding color connection.**

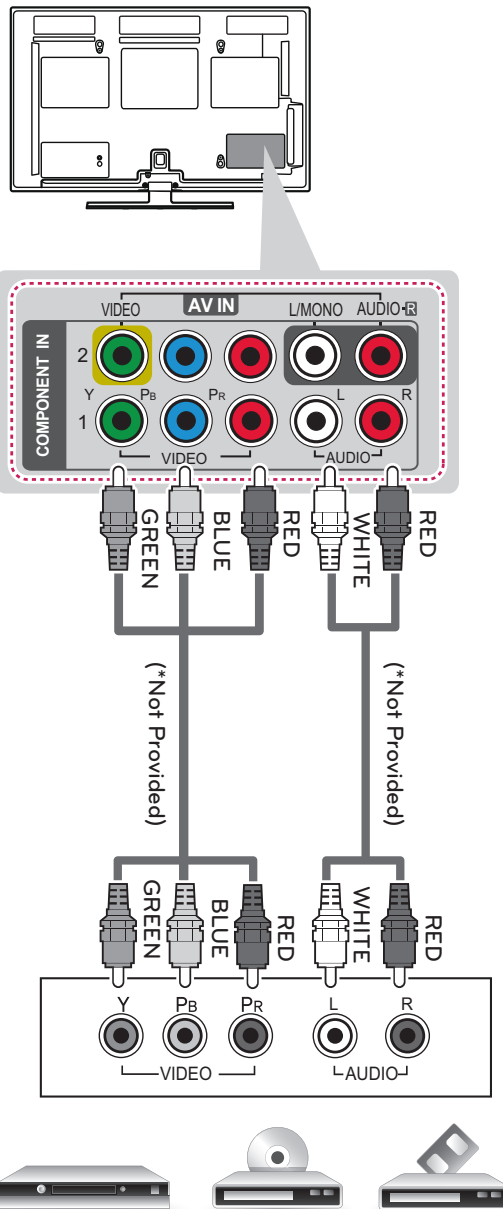

DVD / Blu-Ray / HD Cable Box

## Composite Connection

Transmits the analog video and audio signals from an external device to the TV. Connect the external device and the TV with the composite cable as shown in the following illustration.



**NOTE**

- If you have a mono VCR, connect the audio cable from the VCR to the AUDIO L/MONO jack of the TV.

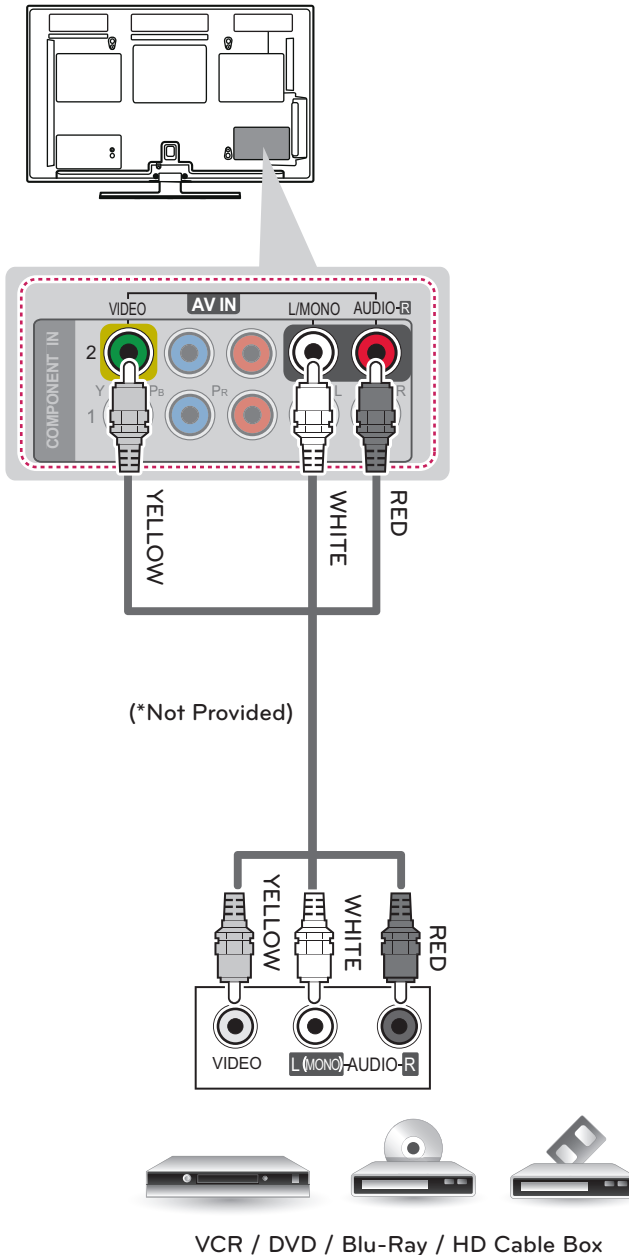

## Connecting to a PC



### NOTE

- It is recommended to use the TV with the HDMI connection for the best image quality.
- Depending on the graphics card, DOS mode may not work if a HDMI to DVI Cable is in use.
- In PC mode, there may be noise associated with the resolution, vertical pattern, contrast or brightness. If noise is present, change the PC output to another resolution, change the refresh rate to another rate or adjust the brightness and contrast on the PICTURE menu until the picture is clear.
- The synchronization input form for Horizontal and Vertical frequencies is separate.
- Depending on the graphics card, some resolution settings may not allow the image to be positioned on the screen properly.

## HDMI Connection, DVI to HDMI Connection or RGB Connection

Choose method A, B, or C to make connection.

### Method A: HDMI Connection

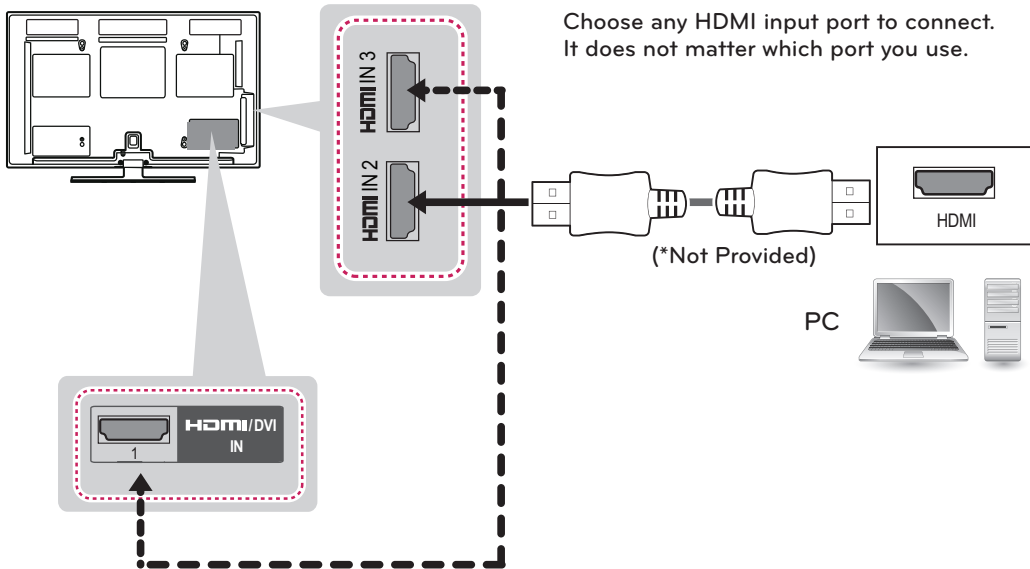

Method B: DVI to HDMI Connection

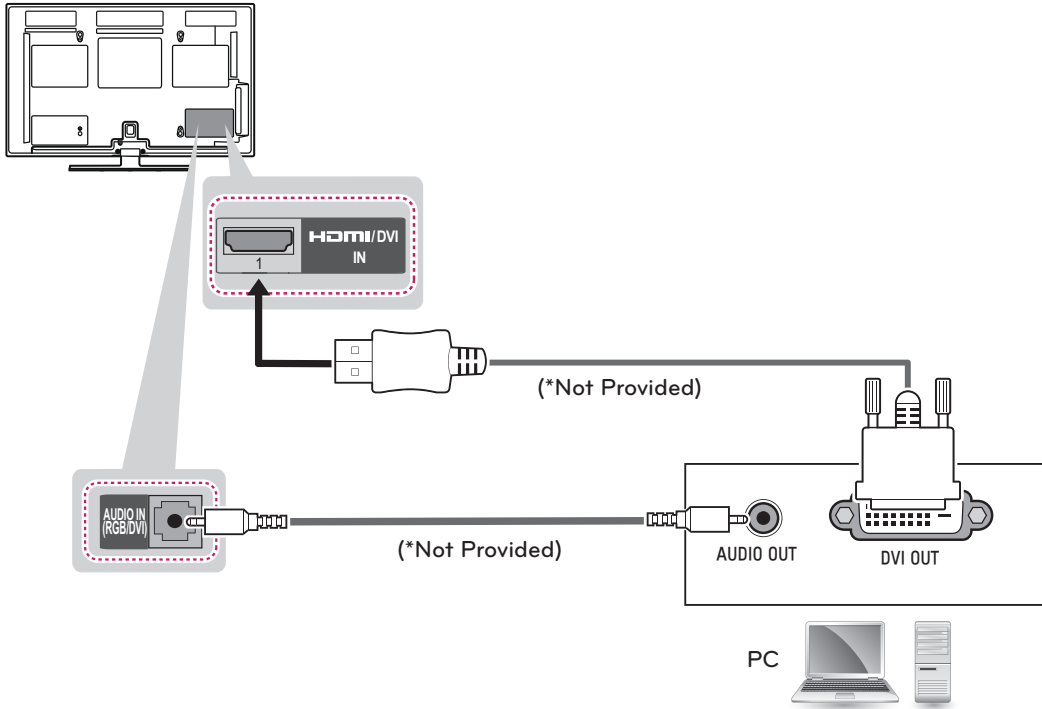

Method C: RGB Connection

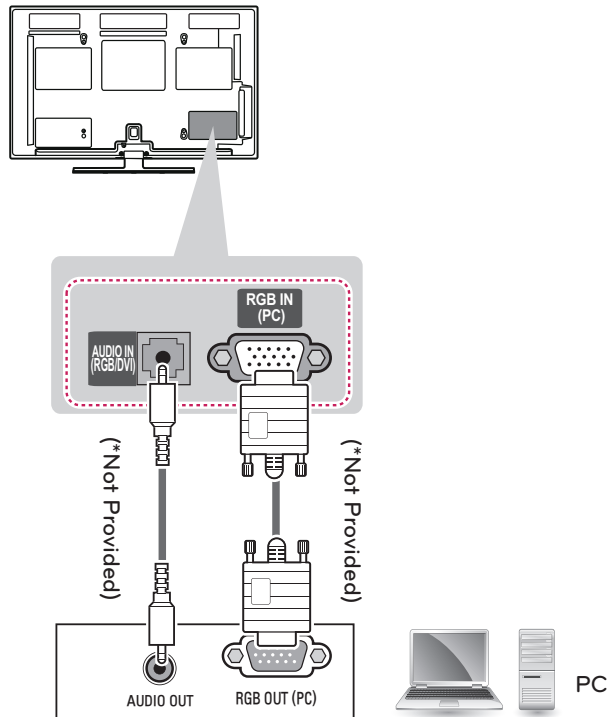

## Connecting to an Audio System

Use an optional external audio system instead of the built-in speaker.



### NOTE

- If you use an optional external audio device instead of the built-in speaker, set the TV speaker feature to off.

### Digital Optical Audio Connection

Transmits the digital audio signal from the TV to an external device. Connect the external device and the TV with the optical audio cable as shown in the following illustration.

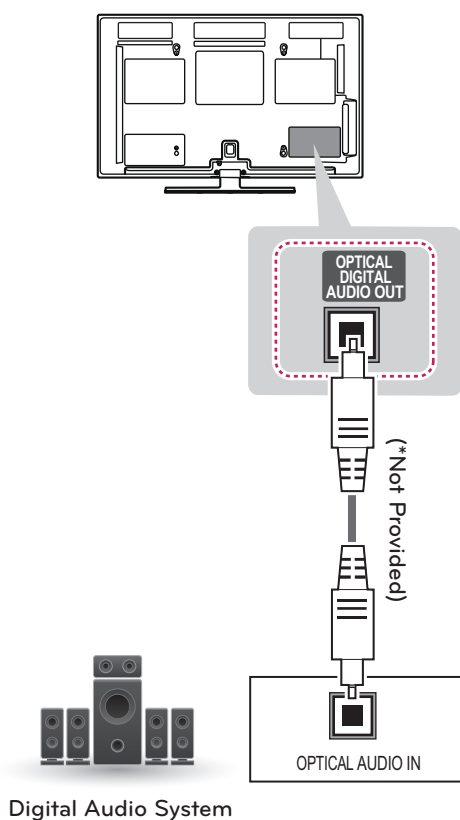

## Connecting to a USB

Connect a USB storage device such as a USB flash memory, external hard drive, or a USB memory card reader to the TV and access the My media menu to use various multimedia files.

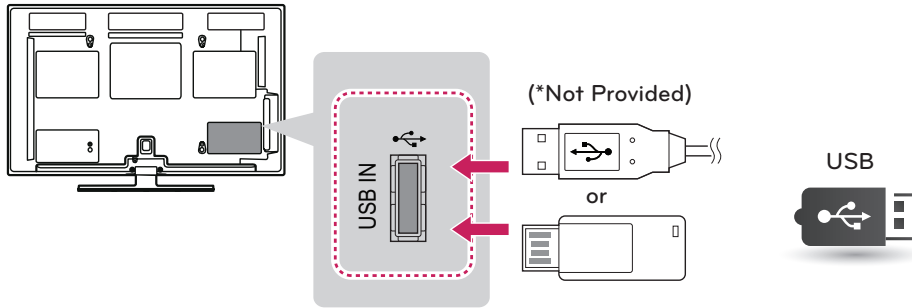

# REMOTE CONTROL

The descriptions in this manual are based on the buttons on the remote control.

Please read this manual carefully and use the TV correctly. To replace batteries, open the battery cover, replace batteries (1.5 V AAA) matching the ⊕ and ⊖ ends to the label inside the compartment, and close the battery cover. To remove the batteries, perform the installation actions in reverse.

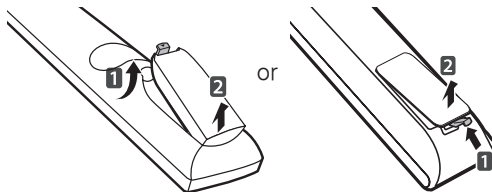

## CAUTION

- Do not mix old and new batteries, as this may damage the remote control.

Make sure to point the remote control toward the remote control sensor on the TV.

For 42PA4500, 42PA450C

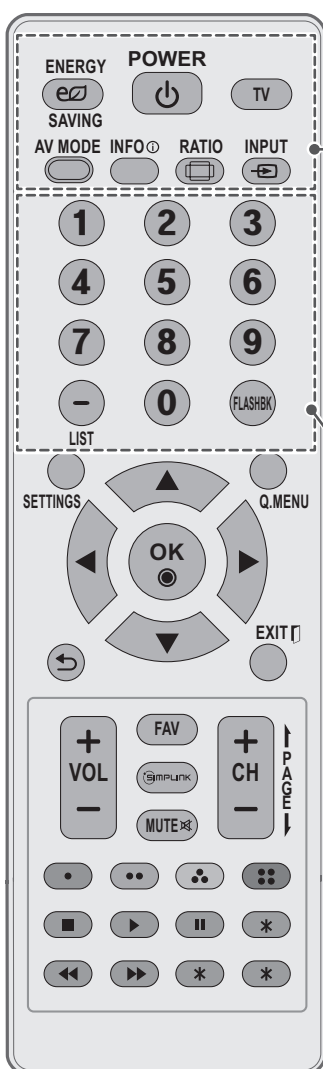

### POWER

Turns the TV on or off.

### ENERGY SAVING

Adjusts the brightness of the screen to reduce energy consumption.

### TV

Returns to the last TV channel.

### AV MODE

Selects an AV mode.

### INFO

Views the information of the current program and screen.

### RATIO

Resizes an image.

### INPUT

Changes the input source; Turns the TV on.

### Number button

Enters numbers.

### LIST, - (Dash)

LIST: Accesses the saved channel list.

- (Dash): Inserts a dash between numbers such as 2-1 and 2-2.

### FLASHBK

Alternates between the two last channels selected (pressing repeatedly).

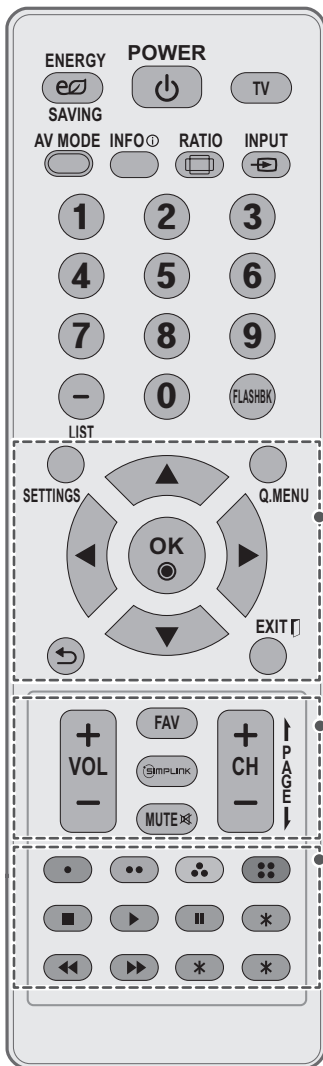

**SETTINGS**

Accesses the main menu.

**Q. MENU**

Accesses the quick menu.

**Navigation buttons** (up/down/left/right)

Scrolls through menus or options.

**OK**

Selects menus or options and confirms your input.

**↶ (BACK)**

Returns to the previous level.

**EXIT**

Clears all on-screen displays and returns to TV viewing.

**+ VOL -**

Adjusts the volume level.

**FAV**

Accesses your favorite channel list.;  
Selects a menu or option.

**SIMPLINK**

Accesses the AV devices connected to the TV;  
Opens the SIMPLINK menu.

**MUTE**

Mutes all sounds.

**+ CH - , ↑ PAGE ↓**

CH: Scrolls through the saved channels.  
PAGE: Moves to the previous or next screen.

**Color buttons**

These access special functions in some menus.

**Control buttons**

Controls the SIMPLINK compatible devices (USB, SIMPLINK).

**|| (FREEZE)**

Freezes the current frame (Not supported when using  
USB Mode and Simplink).

**\***

Not functional

For 50PA4500, 50PA4510, 50PA450C, PA4900, PA5500, PA6500, PA6550, PA550C series

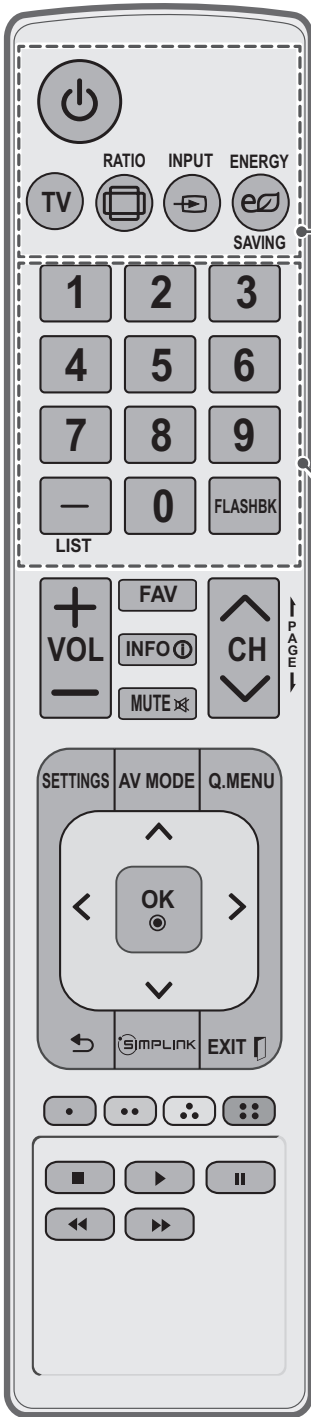

- ⏻ POWER**  
Turns the TV on or off.
- TV**  
Returns to the last TV channel.
- 📺 RATIO**  
Resizes an image.
- 📺 INPUT**  
Changes the input source; Turns the TV on.
- ⚡ ENERGY SAVING**  
Adjusts the brightness of the screen to reduce energy consumption.
- Number button**  
Enters numbers.
- LIST, - (Dash)**  
LIST: Accesses the saved channel list.  
- (Dash): Inserts a dash between numbers such as 2-1 and 2-2.
- FLASHBK**  
Alternates between the two last channels selected (pressing repeatedly).

ENGLISH

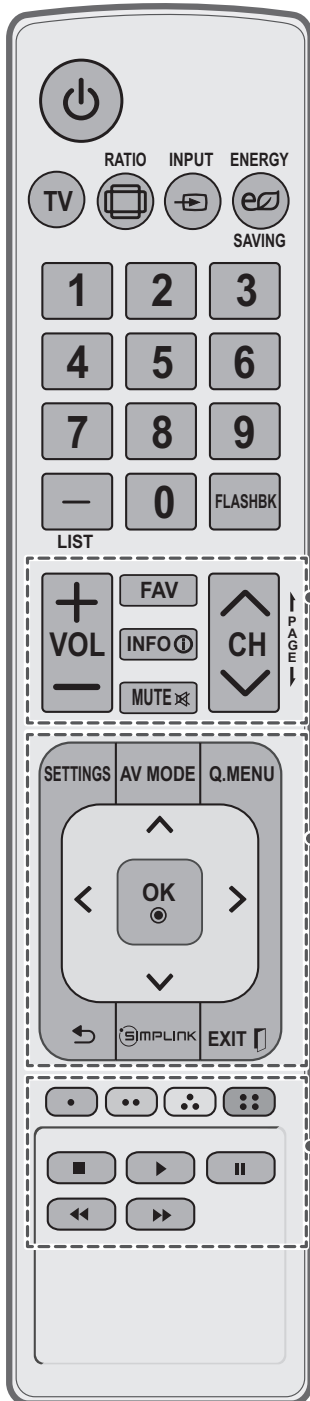

**+ VOL -**  
Adjusts the volume level.

**FAV**  
Accesses your favorite channel list.;  
Selects a menu or option.

**INFO**  
Views the information of the current program and screen.

**MUTE**  
Mutes all sounds.

**^ CH v, | PAGE |**  
CH: Scrolls through the saved channels.  
PAGE: Moves to the previous or next screen.

**SETTINGS**  
Accesses the main menu.

**AV MODE**  
Selects an AV mode.

**Q. MENU**  
Accesses the quick menu.

**Navigation buttons (up/down/left/right)**  
Scrolls through menus or options.

**OK**  
Selects menus or options and confirms your input.

**(BACK)**  
Returns to the previous level.

**SIMPLINK**  
Accesses the AV devices connected to the TV;  
Opens the SIMPLINK menu.

**EXIT**  
Clears all on-screen displays and returns to TV viewing.

**Color buttons**  
These access special functions in some menus.

**Control buttons**  
Controls the SIMPLINK compatible devices (USB, SIMPLINK).

**|| (FREEZE)**  
Freezes the current frame (Not supported when using  
USB Mode and Simplink).

# WATCHING TV

## Turning the TV on for the first time

When you turn the TV on for the first time, the Initial setting screen appears. Select a language and customize the basic settings.

- 1 Connect the power cord to a power outlet.
- 2 In Standby mode, press the power button on the remote control to turn the TV on.

The Initial setting screen appears if you turn the TV on for the first time.

### ! NOTE

- You can also access **Initial Setting** by accessing **OPTION** in the main menu.

- 3 Follow the on-screen instructions to customize your TV settings according to your preferences.

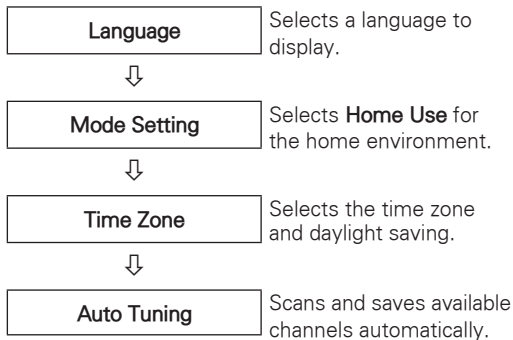

### ! NOTE

- To display images in the best quality for your home environment, select **Home Use**.
- **Store Demo** is suitable for the retail environment.
- If you select **Store Demo**, any customized settings will switch back to the default settings of **Store Demo** in 5 minutes.

- 4 When the basic settings are complete, press **OK**.

### ! NOTE

- If you do not complete the Initial setting, it will appear whenever the TV turns on.
- Disconnect the power cord from the power outlet when you do not use the TV for a long period of time.

- 5 To turn the TV off, press the power button on the remote control.

# USING THE USER GUIDE

User Guide allows you to more easily access the detailed TV information.

- 1 Press **SETTINGS** to access the main menus.
- 2 Press the **RED** button to access the **Customer Support** menus.

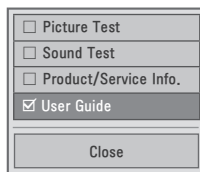
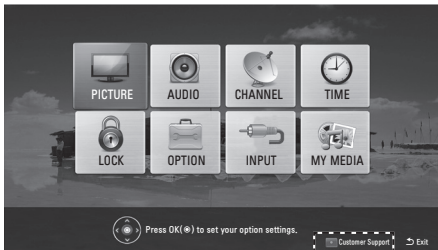

- 3 Press the Navigation buttons to scroll to **User Guide** and press **OK**.

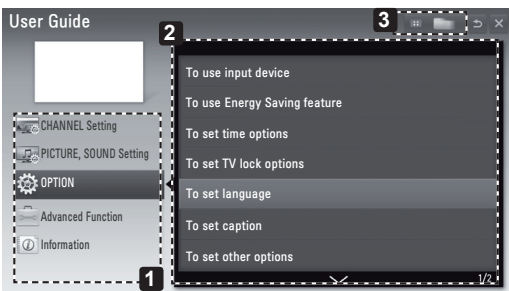

- 1 Allows to select the category you want.
- 2 Allows to select the item you want. You can use  $\wedge/\vee$  to move between pages.
- 3 Allows to browse the description of the function you want from the index.

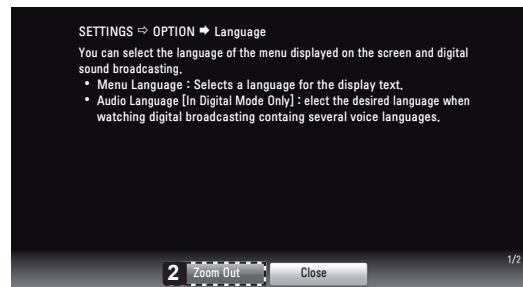

- 1 Shows the description of the selected menu. You can use  $\wedge/\vee$  to move between pages.
- 2 Zooms in or out the screen.

# TROUBLESHOOTING

## General

Problem	Solution
Cannot control the TV with the remote control.	<ul style="list-style-type: none"> <li>• Check the remote control sensor on the product and try again.</li> <li>• Check if there is any obstacle between the product and the remote control.</li> <li>• Check if the batteries are still working and properly installed (⊕ to ⊕, ⊖ to ⊖).</li> </ul>
No image display and no sound is produced.	<ul style="list-style-type: none"> <li>• Check if the product is turned on.</li> <li>• Check if the power cord is connected to a wall outlet.</li> <li>• Check if there is a problem in the wall outlet by connecting other products.</li> </ul>
The TV turns off suddenly.	<ul style="list-style-type: none"> <li>• Check the power control settings. The power supply may be interrupted.</li> <li>• Check if the Auto sleep feature is activated in the Time settings.</li> <li>• If there is no signal while the TV is on, the TV will turn off automatically after 15 minutes of inactivity.</li> </ul>

## Pentouch

Problem	Solution
The touch pen does not work.	<ul style="list-style-type: none"> <li>• Check that you used the remote control to enter Pentouch mode.</li> <li>• Check that the Pentouch dongle is connected to the computer and the red LED is on.</li> <li>• Press the <b>⏻ (POWER)</b> button on the touch pen to check that it is powered on.</li> <li>• Check that the touch pen is paired for use. (The touch pen is correctly paired if the red LED is on once when you press the <b>Touch Home</b> button on the touch pen.)</li> <li>• Set the computer screen to display only on the TV.</li> </ul>
The TV screen doesn't look normal when using Pentouch.	<ul style="list-style-type: none"> <li>• Check that the computer is correctly connected to the TV.</li> <li>• Check that you are using the optimal resolution.</li> <li>• Set the aspect ratio on the TV to Just Scan.</li> </ul>
The touch pen is touched on wrong positions.	<ul style="list-style-type: none"> <li>• Set the computer screen to display only on the TV.</li> <li>• If the point you touch on the TV screen using the touch pen and the point indicated as touched on the computer screen do not match when the computer and the TV are connected by a PC signal (RGB) cable, use the TV remote control to select [SETTINGS] → [Picture] → [Screen] (RGB-PC), then select [Auto Config.] to adjust the screen.</li> </ul>
The touch pen movement is not smooth.	<ul style="list-style-type: none"> <li>• Check whether the computer and the TV are too far from each other. Check whether there are too many obstructions between the computer and the TV.</li> <li>• Check whether many other applications are running on the computer. (Please avoid running other applications while using the Pentouch program.)</li> </ul>

# SPECIFICATIONS

Product specifications may be changed without prior notice due to upgrade of product functions.

Power requirement		AC100 - 240 V ~ 50/60 Hz
Television System		NTSC-M, ATSC, 64 & 256 QAM
Program Coverage		VHF 2-13, UHF 14-69, CATV 1-135, DTV 2-69, CADTV 1-135
External Antenna Impedance		75 Ω
Environment condition	Operating Temperature	0 - 40 °C
	Operating Humidity	Less than 80 %
	Storage Temperature	-20 - 60 °C
	Storage Humidity	Less than 85 %

MODELS		42PA4500 (42PA4500-UM)	50PA4500 (50PA4500-UM)
			50PA4510 (50PA4510-UJ)
Dimensions (W x H x D)	With stand	983.6 mm x 655.0 mm x 246.7 mm (38.7 inch x 25.7 inch x 9.7 inch)	1168.0 mm x 758.0 mm x 297.0 mm (45.9 inch x 29.8 inch x 11.6 inch)
	Without stand	983.6 mm x 601.3 mm x 58.0 mm (38.7 inch x 23.6 inch x 2.2 inch)	1168.0 mm x 704.0 mm x 53.0 mm (45.9 inch x 27.7 inch x 2.0 inch)
Weight	With stand	20.6 kg (45.4 lbs)	28.2 kg (62.1 lbs)
	Without stand	19.0 kg (41.8 lbs)	25.8 kg (56.8 lbs)
Current Value / Power consumption		2.1 A / 210 W	2.8 A / 280 W

MODELS		42PA4900 (42PA4900-UK)	50PA4900 (50PA4900-UK)
Dimensions (W x H x D)	With stand	983.6 mm x 655.0 mm x 246.7 mm (38.7 inch x 25.7 inch x 9.7 inch)	1168.0 mm x 758.0 mm x 297.0 mm (45.9 inch x 29.8 inch x 11.6 inch)
	Without stand	983.6 mm x 601.3 mm x 58.0 mm (38.7 inch x 23.6 inch x 2.2 inch)	1168.0 mm x 704.0 mm x 53.0 mm (45.9 inch x 27.7 inch x 2.0 inch)
Weight	With stand	20.6 kg (45.4 lbs)	28.2 kg (62.1 lbs)
	Without stand	19.0 kg (41.8 lbs)	25.8 kg (56.8 lbs)
Current Value / Power consumption		2.1 A / 210 W	2.8 A / 280 W

MODELS		50PA5500 (50PA5500-UG)	60PA5500 (60PA5500-UG)
		50PA6500 (50PA6500-UG)	60PA6500 (60PA6500-UG)
			60PA6550 (60PA6550-UM)
Dimensions (W x H x D)	With stand	1168.0 mm x 758.0 mm x 297.0 mm (45.9 inch x 29.8 inch x 11.6 inch)	1386.8 mm x 883.2 mm x 354.7 mm (54.5 inch x 34.7 inch x 13.9 inch)
	Without stand	1168.0 mm x 704.0 mm x 53.0 mm (45.9 inch x 27.7 inch x 2.0 inch)	1386.8 mm x 818.2 mm x 53.0 mm (54.5 inch x 32.2 inch x 2.0 inch)
Weight	With stand	28.8 kg (63.4 lbs)	40.6 kg (89.5 lbs)
	Without stand	26.4 kg (58.2 lbs)	36.4 kg (80.2 lbs)
Current Value / Power consumption		2.9 A / 290 W	4.3 A / 430 W

MODELS		42PA450C (42PA450C-UM)	50PA450C (50PA450C-UM)
Dimensions (W x H x D)	With stand	983.6 mm x 655.0 mm x 246.7 mm (38.7 inch x 25.7 inch x 9.7 inch)	1168.0 mm x 758.0 mm x 297.0 mm (45.9 inch x 29.8 inch x 11.6 inch)
	Without stand	983.6 mm x 601.3 mm x 58.0 mm (38.7 inch x 23.6 inch x 2.2 inch)	1168.0 mm x 704.0 mm x 53.0 mm (45.9 inch x 27.7 inch x 2.0 inch)
Weight	With stand	20.6 kg (45.4 lbs)	28.2 kg (62.1 lbs)
	Without stand	19.0 kg (41.8 lbs)	25.8 kg (56.8 lbs)
Current Value / Power consumption		2.1 A / 210 W	2.8 A / 280 W

MODELS		50PA550C (50PA550C-UG)	60PA550C (60PA550C-UG)
Dimensions (W x H x D)	With stand	1168.0 mm x 758.0 mm x 297.0 mm (45.9 inch x 29.8 inch x 11.6 inch)	1386.8 mm x 883.2 mm x 354.7 mm (54.5 inch x 34.7 inch x 13.9 inch)
	Without stand	1168.0 mm x 704.0 mm x 53.0 mm (45.9 inch x 27.7 inch x 2.0 inch)	1386.8 mm x 818.2 mm x 53.0 mm (54.5 inch x 32.2 inch x 2.0 inch)
Weight	With stand	28.8 kg (63.4 lbs)	40.6 kg (89.5 lbs)
	Without stand	26.4 kg (58.2 lbs)	36.4 kg (80.2 lbs)
Current Value / Power consumption		2.9 A / 290 W	4.3 A / 430 W

#### Video Supported Formats (Depending on model)

File Extension name	Video Decoder	Audio Codec	Max Resolution
mpg, mpeg	MPEG1, MPEG2	MP2, MP3, Dolby Digital, LPCM	1920 x 1080 @ 30p (Only Motion JPEG 640x480@30p)
dat	MPEG1	MP2	
ts, trp, tp	MPEG2, H.264, AVS, VC1	MP2, MP3, Dolby Digital	
vob	MPEG1, 2	MP2, MP3, Dolby Digital, LPCM	
mp4, mov, m4v	MPEG4, DivX 3.11, DivX 4.12, DivX 5.x, DivX 6, Xvid 1.00, Xvid 1.01, Xvid 1.02, Xvid 1.03, Xvid 1.10-beta1/2H.264	MP3	
mkv	H.264, MPEG-1,2,4	MP2, MP3, Dolby Digita, LPCM	
divx, avi	MPEG2, MPEG4, DivX 3.11, DivX 4, DivX 5, DivX 6, Xvid 1.00, Xvid 1.01, Xvid 1.02, Xvid 1.03, Xvid 1.10-beta1/2H.264	MP2, MP3, Dolby Digital, LPCM, ADPCM	
Motion JPEG (avi, mp4, mkv)	JPEG	LPCM, ADPCM	
asf, wmv	VC1	WMA	
flv	Sorenson H.263, H264	MP3	

## RGB (PC), HDMI (PC) supported mode

Resolution	Horizontal Frequency (KHz)	Vertical Frequency (Hz)
720x400	31.469	70.08
640x350	31.468	70.09
640x480	31.469	59.94
800x600	37.879	60.31
1024x768	48.363	60.00
1360x768	47.712	60.015
1280x1024 HDMI-PC	63.981	60.02
1920x1080	67.5	60.00

For 50/60PA5500, 50/60PA6500, 60PA6550,  
50/60PA550C

## HDMI (DTV) supported mode

Resolution	Horizontal Frequency (KHz)	Vertical Frequency (Hz)
720x480p	31.47 31.50	59.94 60.00
1280x720p	44.96 45.00	59.94 60.00
1920x1080i	33.72 33.75	59.94 60.00
1920x1080p	26.97 27.00 33.71 33.75 67.432 67.50	23.976 24.00 29.97 30.00 59.94 60.00

## Component port connecting information

Component ports on the TV	Y	P <sub>B</sub>	P <sub>R</sub>
---------------------------	---	----------------	----------------

Video output ports on DVD player	Y	P <sub>B</sub>	P <sub>R</sub>
	Y	B-Y	R-Y
	Y	Cb	Cr
	Y	Pb	Pr

## Component supported mode

Resolution	Horizontal Frequency (KHz)	Vertical Frequency (Hz)
720x480i	15.73 15.73	59.94 60.00
720x480p	31.47 31.50	59.94 60.00
1280x720p	44.96 45.00	59.94 60.00
1920x1080i	33.72 33.75	59.94 60.00
1920x1080p	26.97 27.00 33.71 33.75 67.432 67.50	23.976 24.00 29.97 30.00 59.94 60.00

# MAINTENANCE

## Cleaning Your TV

Clean your TV regularly to keep the best performance and to extend the product lifespan.



### CAUTION

- Make sure to turn the power off and disconnect the power cord and all other cables first.
- When the TV is left unattended and unused for a long time, disconnect the power cord from the wall outlet to prevent possible damage from lightning or power surges.

## Screen, frame, cabinet and stand

To remove dust or light dirt, wipe the surface with a dry, clean, and soft cloth.

To remove major dirt, wipe the surface with a soft cloth dampened in clean water or a diluted mild detergent. Then wipe immediately with a dry cloth.



### CAUTION

- Do not push, rub, or hit the surface with your fingernail or a sharp object, as this may result in scratches on the screen and image distortions.
- Do not use any chemicals, such as waxes, benzene, alcohol, thinners, insecticides, air fresheners, lubricants, as these may damage the screen's finish and cause discoloration.
- Do not spray liquid onto the surface. If water enters the TV, it may result in fire, electric shock, or malfunction.

## Power cord

Remove the accumulated dust or dirt on the power cord regularly.





The model and serial number of the TV is located on the back and/or one side of the TV. Record it below should you ever need service.

MODEL \_\_\_\_\_

SERIAL \_\_\_\_\_

(For PA4900 Series)

The extended owner's manuals that contain information on the advanced features of this LG TV are located on the CD-ROM provided in an electronic version.

To read these files, you will need to use the personal computer (PC) equipped with a CD-ROM drive.

### LG Customer Information Center

For inquires or comments, visit [www.lg.com](http://www.lg.com) or call;

<b>1-888-542-2623</b>	CANADA
<b>1-800-243-0000</b>	USA, Consumer User
<b>1-888-865-3026</b>	USA, Commercial User

Register your product Online!

[www.lg.com](http://www.lg.com)

(For PA450C/PA4500/PA4510 series, 50PA550C, 50PA4900, 50PA5500, 50PA6500 USA, Canada, Mexico)



This product qualifies for ENERGY STAR in the "factory default (Home Use)" setting.

Changing the factory default settings or enabling other features may increase power consumption that could exceed the limits necessary to qualify for ENERGY STAR.



**LG**

Life's Good

OWNER'S MANUAL

# EXTERNAL CONTROL DEVICE SETUP

Please read this manual carefully before operating your set and retain it for future reference.

# IR CODES

(Depending on model)

## How to Connect

Connect your wired remote control to the Remote Control port on the TV.

## Remote Control IR Codes

### Output waveform

Single pulse, modulated with 37.917kHz signal at 455kHz

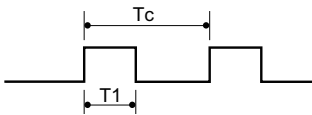

### Frame configuration

1st frame

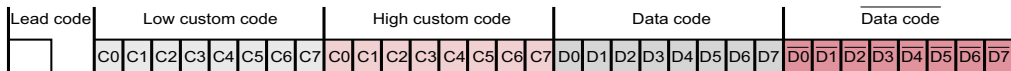

Repeat frame

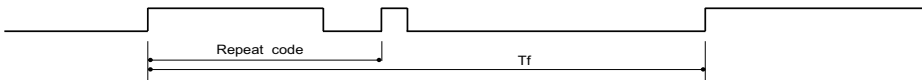

Lead code

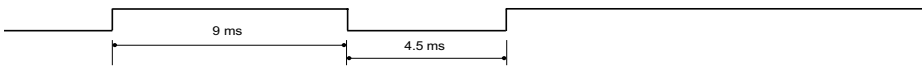

Repeat code

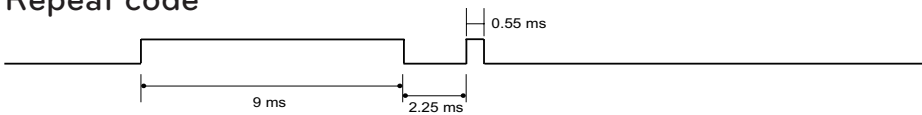

Bit description

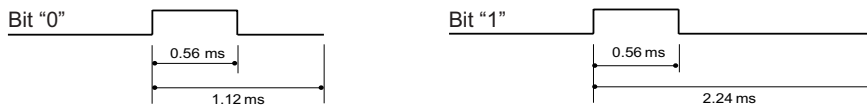

Frame interval: Tf

The waveform is transmitted as long as a key is depressed.

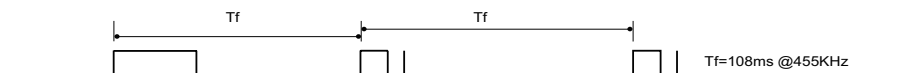

Code (Hexa)	Function	Note	Code (Hexa)	Function	Note
08	⏻ (POWER)	Remote control Button (Power On/Off)	0F	TV	Remote control Button
			DC	3D	Remote control Button
42	Q.MENU/MY APPS	Remote control Button	5B	EXIT	Remote control Button
43	SETTINGS	Remote control Button	7C	HOME	Remote control Button
0B	INPUT	Remote control Button	7A	📺(User-Guide)	Remote control Button
10 - 19	Number Key 0-9	Remote control Button			
4C	- (Dash)/LIST	Remote control Button			
1A	FLASHBK	Remote control Button	D6	TV	Discrete IR Code (TV Input Selection)
09	MUTE	Remote control Button	C4	POWER ON	Discrete IR Code (Only Power Off)
02	VOL +	Remote control Button			
03	VOL -	Remote control Button			
00	CH ▲	Remote control Button	C5	POWER OFF	Discrete IR Code (Only Power Off)
01	CH ▼	Remote control Button			
1E	FAV/MARK	Remote control Button			
40	▲	Remote control Button	5A	AV	Discrete IR Code (AV Input Selection)
41	▼	Remote control Button			
07	<	Remote control Button	BF	COMPONENT1	Discrete IR Code (Component1 Input Selection)
06	>	Remote control Button			
44	OK	Remote control Button	D4	COMPONENT2	Discrete IR Code (Component2 Input Selection)
28	↩ (BACK)	Remote control Button			
79	RATIO	Remote control Button	D5	RGB-PC	Discrete IR Code (RGB-PC Input Selection)
BA	⏸ (FREEZE)	Remote control Button			
95	ENERGY SAVING	Remote control Button	CE	HDMI1	Discrete IR Code (HDMI1 Input Selection)
7E	SIMPLINK	Remote control Button			
AA	INFO	Remote control Button	CC	HDMI2	Discrete IR Code (HDMI2 Input Selection)
30	AV MODE	Remote control Button			
72	RED	Remote control Button	E9	HDMI3	Discrete IR Code (HDMI3 Input Selection)
71	GREEN	Remote control Button			
63	YELLOW	Remote control Button	DA	HDMI4	Discrete IR Code (HDMI4 Input Selection)
61	BLUE	Remote control Button			
B1	■	Remote control Button	76	Ratio 4:3	Discrete IR Code (Only 4:3 Mode)
B0	▶	Remote control Button			
BA	⏸	Remote control Button	77	Ratio 16:9	Discrete IR Code (Only 16:9 Mode)
8E	▶▶	Remote control Button			
8F	◀◀	Remote control Button			
			AF	Ratio Cinema Zoom	Discrete IR Code (Only Cinema Zoom Mode)

- Use the feature depending on your model.

# EXTERNAL CONTROL DEVICE SETUP

## RS-232C Setup

Connect the RS-232C (serial port) input jack to an external control device (such as a computer or an A/V control system) to control the product's functions externally.

Connect the serial port of the control device to the RS-232C jack on the product back panel.



### NOTE

- RS-232C on this TV is intended to be used with third party RS-232C control hardware and software. The instructions below are provided to help with programming software or to test functionality using telenet software. RS-232C connection cables are not supplied with the product.

## Type of connector; D-Sub 9-Pin Male

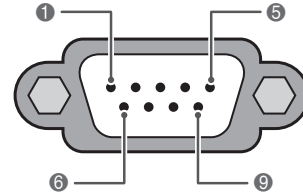

RS-232C IN  
(CONTROL & SERVICE)

No.	Pin name
1	No connection
2	RXD (Receive data)
3	TXD (Transmit data)
4	DTR (DTE side ready)
5	GND
6	DSR (DCE side ready)
7	RTS (Ready to send)
8	CTS (Clear to send)
9	No Connection

## RS-232C configurations

### 7-Wire Configuration

(Serial female-female NULL modem cable)

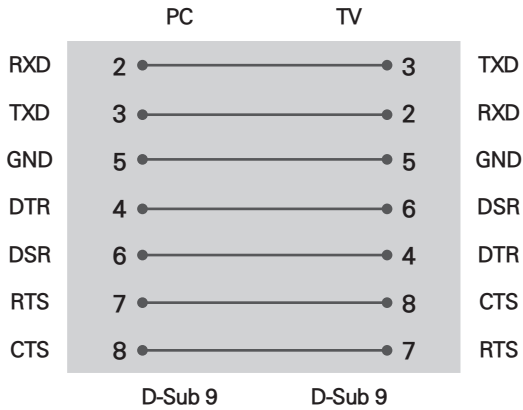

### 3-Wire Configurations(Not standard)

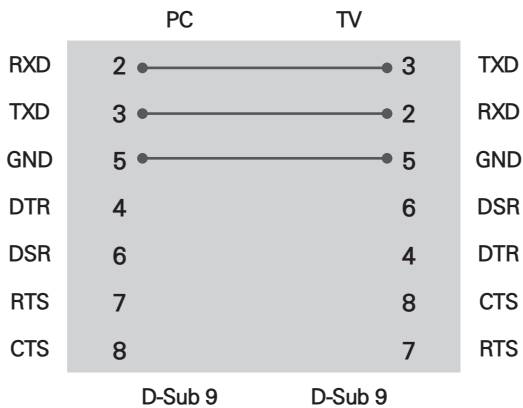

### Set ID

Set ID number.

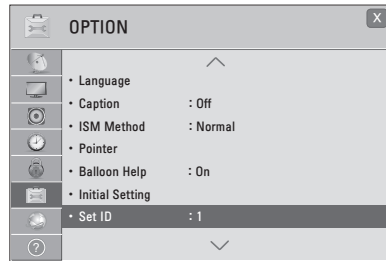

- 1 Press **SETTINGS** to access the main menu.
- 2 Press the Navigation buttons to scroll to **SETUP** and press **OK**.
- 3 Press the Navigation buttons to scroll to **OPTION** and press **OK**.
- 4 Press the Navigation buttons to scroll to **Set ID** and press **OK**.
- 5 Scroll left or right to select a set ID number and select **CLOSE**. The adjustment range is 1-99.
- 6 When you are finished, press **EXIT**.

```
*Real data mapping
0 : Step 0
  :
A : Step 10 (SET ID 10)
  :
F : Step 15 (SET ID 15)
10 : Step 16 (SET ID 16)
  :
63 : Step 99 (SET ID 99)
64 : Step 100
```

## Communication Parameters

- Baud rate: 9600 bps (UART)
- Data length: 8 bits
- Parity : None
- Stop bit: 1 bit
- Communication code: ASCII code
- Use a crossed (reverse) cable.

## Command reference list

	COMMAND1	COMMAND2	DATA (Hexadecimal)		COMMAND1	COMMAND2	DATA (Hexadecimal)
01. Power	k	a	00 - 01	14. Balance	k	t	00 - 64
02. Input Select	x	b	(See p.8)	15. 3D (For 3D TV)	x	t	(See p.9)
03. Aspect Ratio	k	c	(See p.8)	16. Color Temperature	x	u	00 - 64
04. Screen Mute	k	d	00 - 01	17. Extended 3D (For 3D TV)	x	v	(See p.9)
05. Volume Mute	k	e	00 - 01	18. ISM Method	j	p	(See p.9)
06. Volume Control	k	f	00 - 64	19. Energy Saving	j	q	(See p.9)
07. Contrast	k	g	00 - 64	20. Auto Configuration	j	u	(See p.10)
08. Brightness	k	h	00 - 64	22. Channel Add/Del	m	b	00 - 01
09. Color	k	i	00 - 64	23. Key	m	c	(See p.10)
10. Tint	k	j	00 - 64				
11. Sharpness	k	k	00 - 32				
12. OSD Select	k	l	00 - 01				
13. Remote Control Lock Mode	k	m	00 - 01				

	COMMAND1	COMMAND2	DATA00 (Hexadecimal)	DATA01 (Hexadecimal)	DATA02 (Hexadecimal)	DATA03 (Hexadecimal)	DATA04 (Hexadecimal)	DATA05 (Hexadecimal)
21. Channel Tuning	m	a	physical program high	major program low	major low	minor high	minor low	attribute

## Transmission / Receiving protocol

### Transmission

[Command1][Command2][ ][Set ID][ ][Data][Cr]

[Command 1] : First command to control the set.(j, k, m or x)

[Command 2] : Second command to control the set.

[Set ID] : You can adjust the set ID to choose desired set ID number in Option menu. Adjustment range is 1~ 99. When selecting Set ID '0', every connected the set is controlled. Set ID is indicated as decimal (1~ 99) on menu and as Hexa decimal (0x0~ 0x63) on transmission /receiving protocol.

[DATA] : To transmit the command data.

Transmit the 'FF' data to read status of command.

[Cr] : Carriage Return

ASCII code '0x0D'

[ ] : ASCII code 'space (0x20)'

\* In this model, set will not send the status during the standby mode.

### OK Acknowledgement

[Command2][ ][Set ID][ ][OK][Data][x]

The set transmits ACK (acknowledgement) based on this format when receiving normal data. At this time, if the data is data read mode, it indicates present status data. If the data is data write mode, it returns the data of the PC computer.

\* In this model, set will not send the status during the standby mode.

\* Data Format

[Command 2] : Use as command.

[Set ID] : Use the small character, if set ID is 10, it will send the '0', 'a'.

[DATA] : Use the small character, if data is 0 x ab, it will send the 'a', 'b'.

[OK] : Use the large character.

### Error Acknowledgement

[Command2][ ][Set ID][ ][NG][Data][x]

The set transmits ACK (acknowledgement) based on this format when receiving abnormal data from non-viable functions or communication errors.

Data01: Illegal Code

Data02: Not supported function

Data03: Wait more time

\* In this model, set will not send the status during the standby mode.

\* Data Format

[Command 2] : Use as command.

[Set ID] : Use the small character, if set ID is 10, it will send the '0', 'a'.

[DATA] : Use the small character, if data is 0 x ab, it will send the 'a', 'b'.

[NG] : Use the large character

**01. Power (Command: k a)**

To control Power On/Off of the set.

Transmission [k][a][ ][Set ID][ ][Data][Cr]

Data 00: Power Off Data 01: Power On

Acknowledgement [a][ ][Set ID][ ][OK/NG][Data][x]

\* In a like manner, if other functions transmit 'FF' data based on this format, Acknowledgement data feedback presents status about each function.

\* Note: In this model, set will send the Acknowledge after power on processing completion.  
There might be a time delay between command and acknowledge.

**02. Input Select (Command: x b)**

To select input source for set.

Transmission [x][b][ ][Set ID][ ][Data][Cr]

Data 00: DTV (Antenna) Data 01: DTV (Cable)  
Data 10: Analog (Antenna) Data 11: Analog (Cable)  
Data 20: AV or AV1 Data 21: AV2  
Data 40: Component1 Data 41: Component2  
Data 42: Component3 Data 60: RGB-PC  
Data 90: HDMI1 Data 91: HDMI2  
Data 92: HDMI3 Data 93: HDMI4

Acknowledgement [b][ ][Set ID][ ][OK/NG][Data][x]

\* Use the feature depending on your model.

**03. Aspect Ratio (Command: k c)**

To adjust the screen format.

Transmission [k][c][ ][Set ID][ ][Data][Cr]

Data 01: 4:3 Data 09: Just scan  
Data 02: 16:9 Data 10: Cinema Zoom 1  
Data 04: Zoom  
Data 06: Set by program :  
Data 1F: Cinema Zoom16

Acknowledgement [c][ ][Set ID][ ][OK/NG][Data][x]

**04. Screen Mute (Command: k d)**

To select screen mute on/off.

Transmission [k][d][ ][Set ID][ ][Data][Cr]

Data 00: Screen mute off (Picture on), Video-out Mute off  
Data 01: Screen mute on (Picture off)  
Data 10: Video-out Mute on

Acknowledgement [d][ ][Set ID][ ][OK/NG][Data][x]

\* In case of Video-out Mute on only, TV will display On Screen Display (OSD). But, in case of screen mute on, TV will not display On Screen Display (OSD).

**05. Volume Mute (Command: k e)**

To control volume mute on/off.

You can also adjust mute using the MUTE button on remote control.

Transmission [k][e][ ][Set ID][ ][Data][Cr]

Data 00: Volume mute on (Volume off)  
Data 01: Volume mute off (Volume on)

Acknowledgement [e][ ][Set ID][ ][OK/NG][Data][x]

**06. Volume Control (Command: k f)**

To adjust volume.

You can also adjust volume with the volume buttons on remote control.

Transmission [k][f][ ][Set ID][ ][Data][Cr]

Data Min: 00 ~ Max: 64 (\*transmit by Hexadecimal code)

\*Refer to "Real data mapping".

Acknowledgement [f][ ][Set ID][ ][OK/NG][Data][x]

**07. Contrast (Command: k g)**

To adjust screen contrast.

You can also adjust contrast in the PICTURE menu.

Transmission [k][g][ ][Set ID][ ][Data][Cr]

Data Min: 00 ~ Max: 64 (\*transmit by Hexadecimal code)

\*Refer to "Real data mapping".

Acknowledgement [g][ ][Set ID][ ][OK/NG][Data][x]

**08. Brightness (Command: k h)**

To adjust screen brightness.

You can also adjust brightness in the PICTURE menu.

Transmission [k][h][ ][Set ID][ ][Data][Cr]

Data Min: 00 ~ Max: 64 (\*transmit by Hexadecimal code)

\*Refer to "Real data mapping".

Acknowledgement [h][ ][Set ID][ ][OK/NG][Data][x]

**09. Color (Command: k i)**

To adjust screen color.

You can also adjust color in the PICTURE menu.

Transmission [k][i][ ][Set ID][ ][Data][Cr]

Data Min: 00 ~ Max: 64 (\*transmit by Hexadecimal code)

\*Refer to "Real data mapping".

Acknowledgement [i][ ][Set ID][ ][OK/NG][Data][x]

**10. Tint (Command: k j)**

To adjust screen tint.

You can also adjust tint in the PICTURE menu.

Transmission [k][j][ ][Set ID][ ][Data][Cr]

Data Red: 00 ~ Green: 64 (\*transmit by Hexadecimal code)

\*Refer to "Real data mapping".

Acknowledgement [ j ][ ][Set ID][ ][OK/NG][Data][x]

**11. Sharpness (Command: k k)**

To adjust screen sharpness.

You can also adjust sharpness in the PICTURE menu.

Transmission [k][k][ ][Set ID][ ][Data][Cr]

Data Min: 00 ~ Max: 32 (\*transmit by Hexadecimal code)

\*Refer to "Real data mapping".

Acknowledgement [k][ ][Set ID][ ][OK/NG][Data][x]

**12. OSD Select (Command: k l)**

To select OSD (On Screen Display) on/off.

Transmission [k][l][ ][Set ID][ ][Data][Cr]

Data 00: OSD off    Data 01: OSD on

Acknowledgement [l][ ][Set ID][ ][OK/NG][Data][x]

**13. Remote Control Lock Mode (Command: k m)**

To lock the remote control and the front panel controls on the set.

Transmission [k][m][ ][Set ID][ ][Data][Cr]

Data 00: Lock off    Data 01: Lock on

Acknowledgement [m][ ][Set ID][ ][OK/NG][Data][x]

If you're not using the remote control and front panel controls on the Monitor set, use this mode. When main power is on/off, remote control lock is released. If Key Lock is on in the standby mode, TV will not turn on by POWER button of remote control and on the TV.

**14. Balance (Command: k t)**

To adjust balance.

You can also adjust balance in the AUDIO menu.

Transmission [k][t][ ][Set ID][ ][Data][Cr]

Data Min: 00 ~ Max: 64 (\*transmit by Hexadecimal code)  
\*Refer to "Real data mapping".

Acknowledgement [t][ ][Set ID][ ][OK/NG][Data][x]

**15. 3D (Command: x t) (For 3D TV)**

To change 3D mode for TV.

Transmission [x][t][ ][Set ID][ ][Data01]

[ ][Data02][ ][Data03][ ][Data04][Cr]

Data1

00: 3D On                      01: 3D Off  
02: 3D to 2D                03: 2D to 3D

Data2

00: Top and Bottom        01: Side by Side  
02: Check Board          03: Single Frame Sequential  
04: Column interleaving   05: Row interleaving

Data3

00: Right to Left        01: Left to Right

Data4

3D Depth: Min : 00 ~ Max : 14  
(\*transmit by Hexadecimal code)

\*If data1 is 01(3D Off) , data2 , data3 , data4 have no meaning.

\*If data1 is 02(3D to 2D), data2, data3 and data4 have no meaning.

\*If data1 is 03(2D to 3D), data2 and data3 have no meaning.

Data 01	Data 02	Data 03	Data 04
00	o	o	x
01	x	x	x
02	x	x	x
03	x	x	o

x : Don't care

Acknowledgement [t][ ][OK][Data01][Data02][Data03][Data04][x][t][ ][NG][Data01][x]

**16. Color Temperature (Command: x u)**

To adjust color temperature.

You can also adjust color temperature in the PICTURE menu.

Transmission [x][u][ ][Set ID][ ][Data][Cr]

Data Min: 00 ~ Max: 64 (\*transmit by Hexadecimal code)  
\*Refer to "Real data mapping".

Acknowledgement [u][ ][Set ID][ ][OK/NG][Data][x]

**17. Extended 3D (Command: x v) (For 3D TV)**

To change 3D option for TV. Use the feature depending on your model.

Transmission [x][v][ ][Set ID][ ][Data01][ ][Data02][Cr]

Data1: 3D option

00: 3D Picture Correction  
01: 3D Depth  
02: 3D Viewpoint  
07: 3D Sound Zooming  
08: Normal Image View  
09: 3D Mode

Data2: It has own range for each 3D option determined by Data1.

1) When Data1 is 00

00: Right to Left                      01: Left to Right

2) When Data1 is 01

Data Min: 00 ~ Max: 14 (\*transmit by Hexadecimal code)

3) When Data1 is 02

Data Min: 00 ~ Max: 14 (\*transmit by Hexadecimal code)

4) When Data1 is 07

00: Off                                      01: On

5) When Data1 is 08

00: Off                                      01: On

6) When Data1 is 09

00: Standard                              01: Sports  
02: Cinema                                03: Extreme

04: Manual

Acknowledgement [v][ ][OK][Data01][Data02][x][v][ ][NG][Data01][x]

\* Use the feature depending on your model.

**18. ISM Method (Command: j p)**

To avoid having a fixed image remain on screen.

Transmission [j][p][ ][Set ID][ ][Data][Cr]

Data 02: Orbiter

08: Normal  
20: Color Wash

Acknowledgement [p][ ][Set ID][ ][OK/NG][Data][x]

**19. Energy Saving (Command: j q)**

To control the energy saving function.

Transmission [j][q][ ][Set ID][ ][Data][Cr]

Data 00: off

- 01: Minimum
- 02: Medium
- 03: Maximum
- 04: Intelligent Sensor
- 05: Screen off

Acknowledgement [q][ ][Set ID][ ][OK/NG][Data][x]

## 20. Auto Configuration (Command: j u)

To adjust picture position and minimize image shaking automatically. Auto configuration only works in RGB-PC mode.

Transmission [ j ][u][ ][Set ID][ ][Data][Cr]

Data 01: To set

Acknowledgement [u][ ][Set ID][ ][OK/NG][Data][x]

## 21. Channel Tuning (Command: m a)

To tune channel to following physical/major/minor number.

(This feature is not available for all models.)

Transmission [m][a][ ][Set ID][ ][Data00][ ][Data01][ ][Data02][ ][Data03][ ][Data04][ ][Data05][Cr]

Digital channels have a Physical, Major, and Minor channel number. The Physical number is the actual digital channel number, the Major is the number that the channel should be mapped to, and the Minor is the sub-channel. Since the ATSC tuner automatically maps the channel to the Major number, the Physical number is not required when sending a command.

Data 00: Physical Channel Number  
NTSC air: 02~45, NTSC cable: 01, 0E~7D

ATSC air: 01~45, ATSC cable: 01~87

Data 01 & 02: Major Channel Number

Data 01: High byte Data 02: Low byte

Two bytes are available for the Major and Minor, normally only the second byte is used.

Data 03 & 04: Minor Channel Number

Not needed for NTSC.

The table lists the binary code which must be converted to Hexadecimal before sending. For example:

The binary code to tune the sub source to an NTSC cable channel is "1000 0001", which translates to "81" in Hex.

- \* 7th bit : For which source do you want to change the channel.
- \* 6th bit: Use a two part or one part channel. Most cases just use 0 since it's ignored when using NTSC.
- \* 5th bit: Use 0 with NTSC since it can only use the physical channel number. Normally use 1 for ATSC since most times it doesn't matter what the physical number is.
- \* 4th bit: Set to 0.
- \* 3-0 bits: Choose signal type.

\* Tune Command Examples:

1. Tune to the analog (NTSC) cable channel 35.

Data 00 = Physical of 35 = 23

Data 01 & 02 = No Major = 00 00

Data 03 & 04 = No Minor = 00 00

Data 05 = 0000 0001 in binary = 01

Total = ma 00 23 00 00 00 01

2. Tune to the digital (ATSC) local channel 30-3.

Data 00 = Don't know Physical = 00

Data 01 & 02 = Major is 30 = 00 1E

Data 03 & 04 = Minor is 3 = 00 03

Data 05 = 0010 0010 in binary = 22

Total = ma 00 00 00 1E 00 03 22

## 22. Channel Add/Del (Command: m b)

To add and delete the channels.

Transmission [m][b][ ][Set ID][ ][Data][Cr]

Data 00: Channel Delete Data 01: Channel Add

Acknowledgement [b][ ][Set ID][ ][OK/NG][Data][x]

## 23. Key (Command: m c)

To send IR remote key code.

Transmission [m][c][ ][Set ID][ ][Data][Cr]

See page 3.

Acknowledgement [c][ ][Set ID][ ][OK/NG][Data][x]

When TV is in the standby mode, TV will turn on by POWER button of remote control only.

\* Table List (Channel Tuning)

7	Main/Sub Picture	6	Two/One Part Channel	5	Using Physical Channel	4 Reserved	3	2	1	0	Step
0	Main	0	Two	0	Use	x	0	0	0	0	NTSC Air
1	Sub	1	One	1	No Use	x	0	0	0	1	NTSC Cable
						x	0	0	1	0	ATSC Air
						x	0	0	1	1	ATSC Cable_std
						x	0	1	0	0	ATSC Cable_hrc
						x	0	1	0	1	ATSC Cable_irc
						x	0	1	1	0	ATSC cable_auto
						x	0	1	1	1	Reserved
						x	x	x	x	x	...
						x	1	1	1	1	Reserved

