

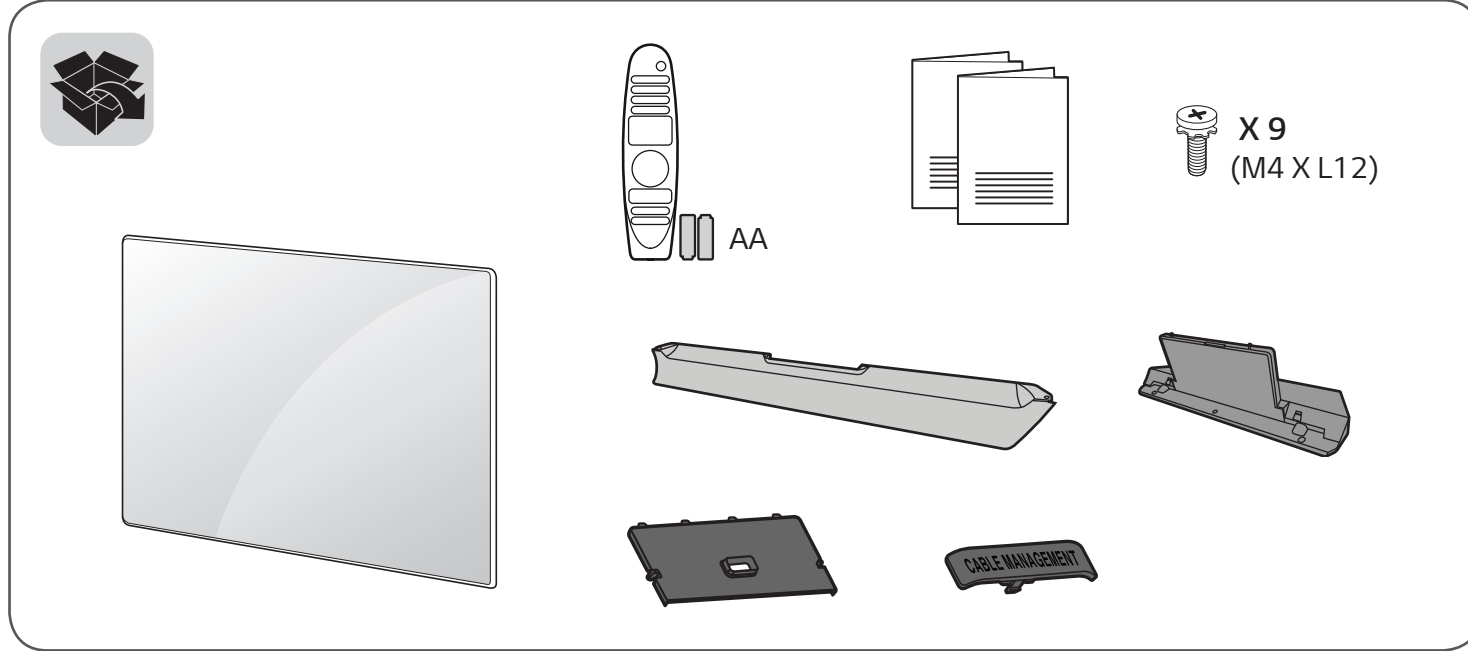

www.lg.com

OLED55C8*
OLED65C8*
OLED77C8*



!

English •Read **Safety and Reference**.
•For the power supply and power consumption, refer to the label attached to the product.

Türkçe •**Güvenlik ve Referans** bölümünü okuyun.
•Güç kaynağı ve güç tüketimi için ürüne yapıştırılmış olan etikete bakın.

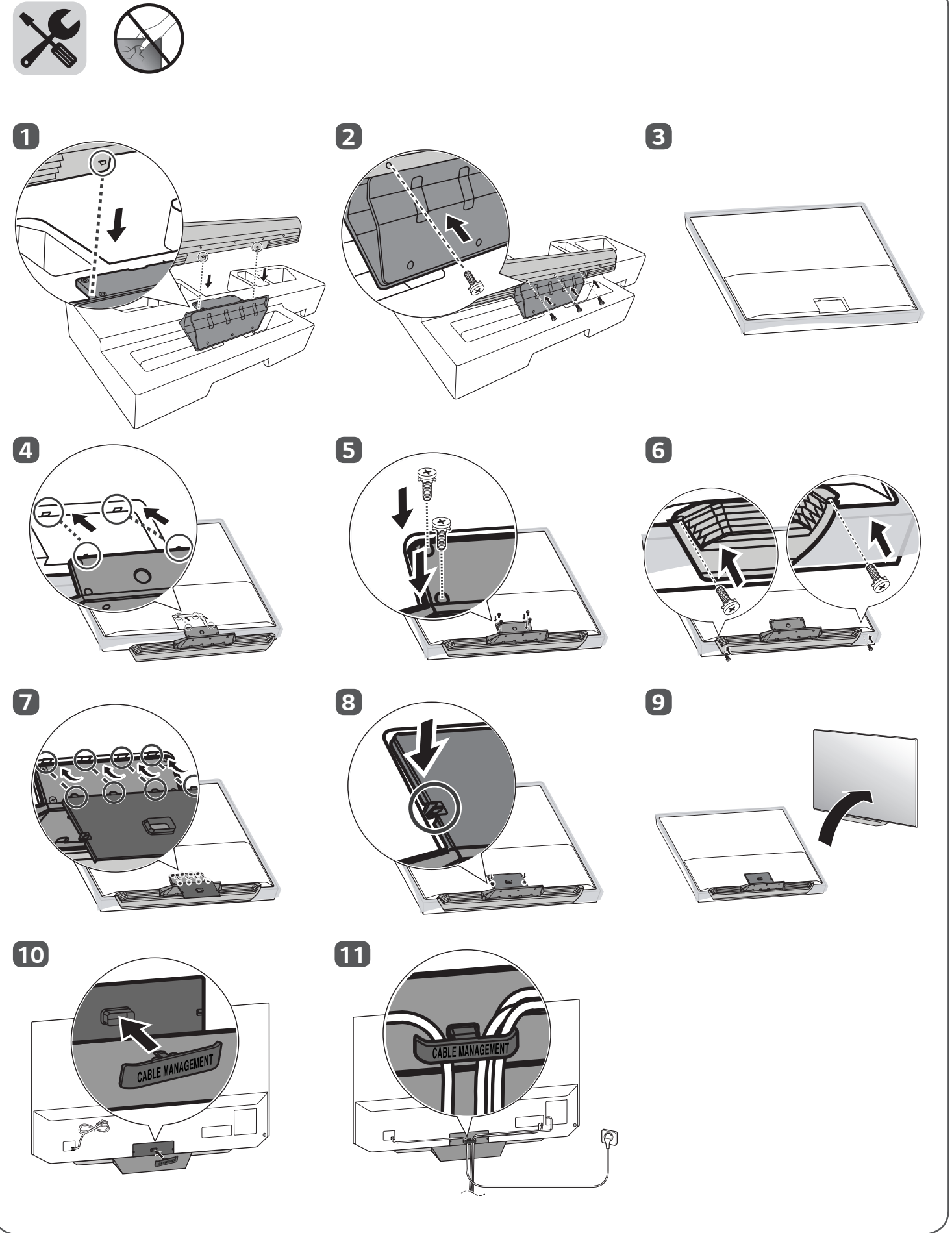

+ : Depending on model / Modele bağlı olarak değişiklik gösterebilir



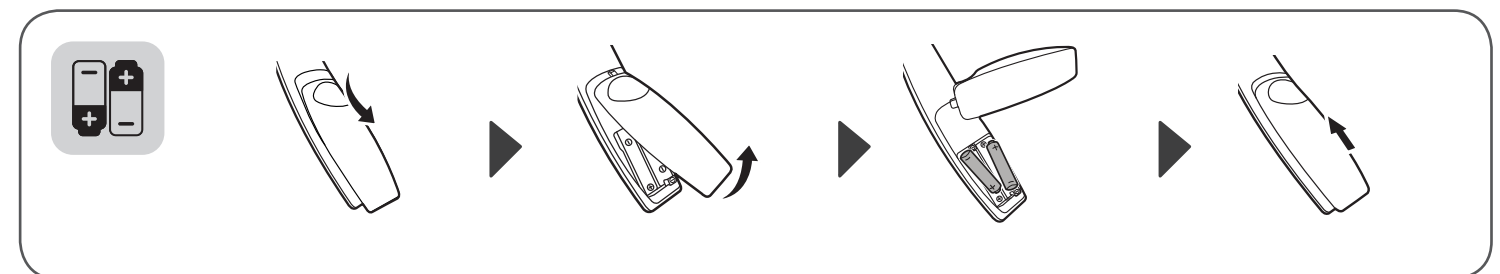
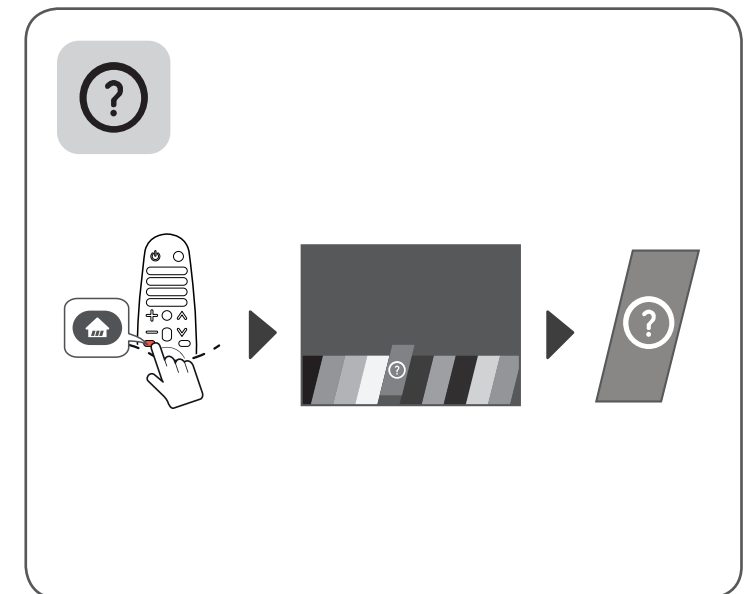
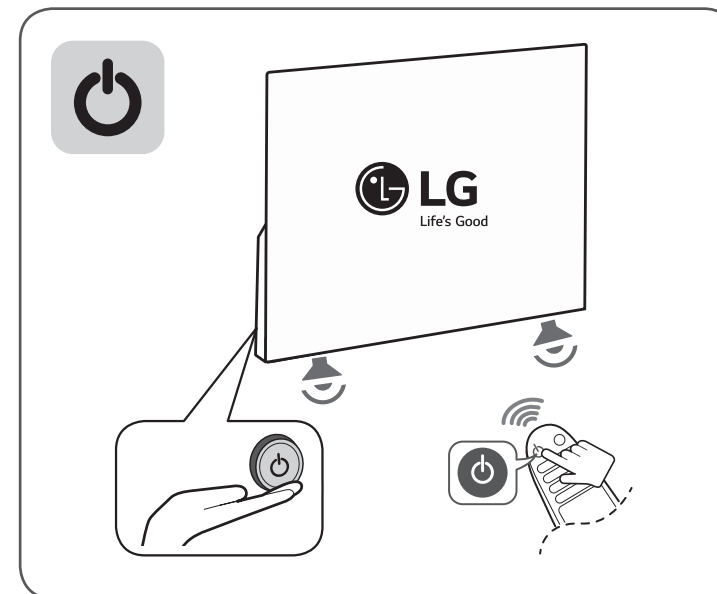
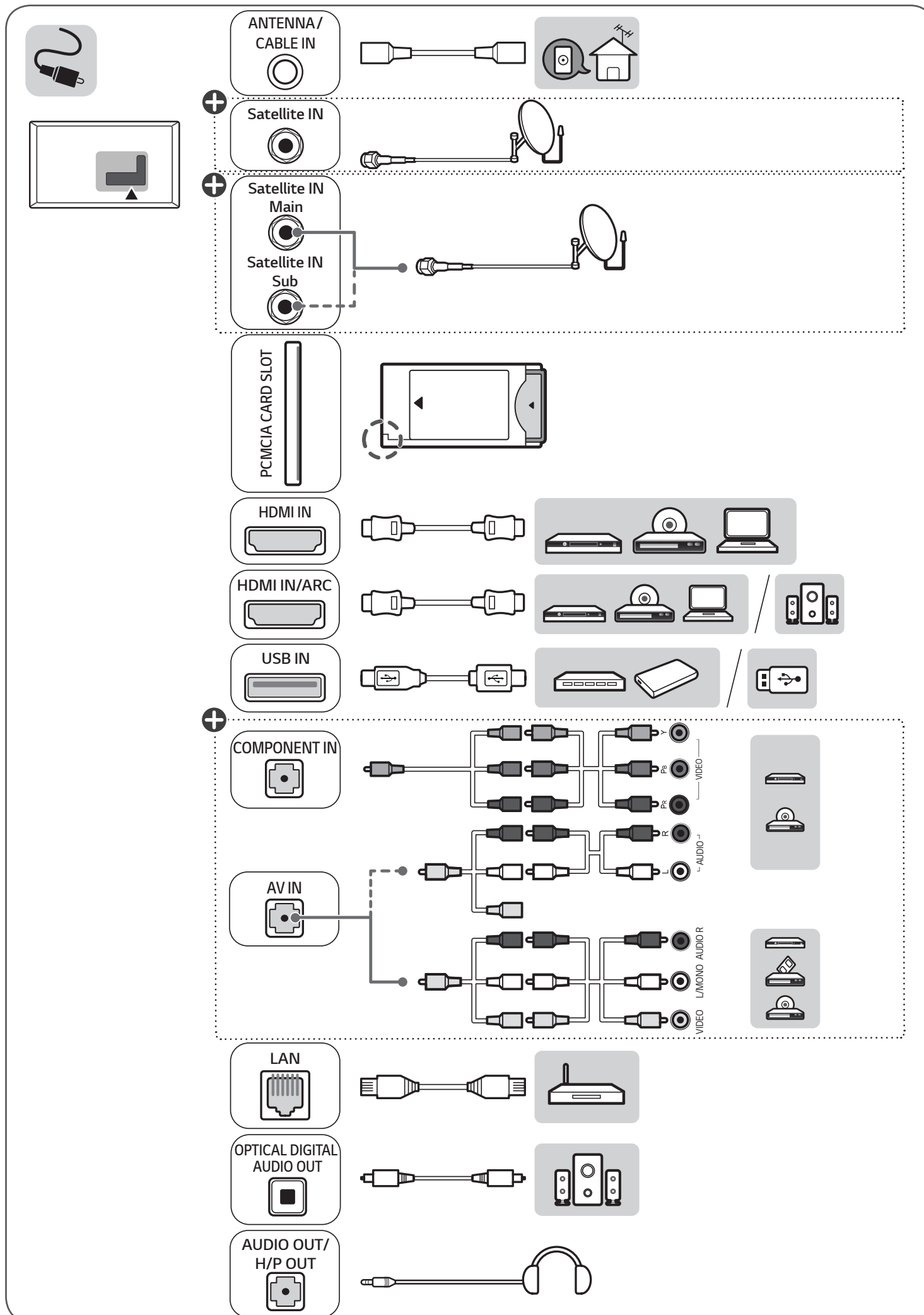

	A	B	C	D	E	F	F-G
	(mm)					(kg)	
OLED55C8PLA	1228	757	230	707	46.9	19.1	16.3
OLED55C8LLA							
OLED65C8PLA	1449	881	230	831	46.9	26.1	21.7
OLED65C8LLA							
OLED77C8PLA	1722	1052	253	991	56	36.5	29.9
OLED77C8LLA							
Power requirement / Güç gereksinimi			AC 100-240 V ~ 50 / 60 Hz				



LG OLED TV

Safety and Reference



Please read this manual carefully before operating your set and retain it for future reference.

www.lg.com





Copyright © 2018 LG Electronics Inc.
All Rights Reserved.

Warning! Safety Instructions

	CAUTION RISK OF ELECTRIC SHOCK DO NOT OPEN	
---	---	---

CAUTION : TO REDUCE THE RISK OF ELECTRIC SHOCK, DO NOT REMOVE COVER (OR BACK). NO USER-SERVICEABLE PARTS INSIDE. REFER TO QUALIFIED SERVICE PERSONNEL.

 This symbol is intended to alert the user to the presence of uninsulated "dangerous voltage" within the product's enclosure that may be of sufficient magnitude to constitute a risk of electric shock to persons.

 This symbol is intended to alert the user to the presence of important operating and maintenance (servicing) instructions in the literature accompanying the appliance.

WARNING : TO REDUCE THE RISK OF FIRE AND ELECTRIC SHOCK, DO NOT EXPOSE THIS PRODUCT TO RAIN OR MOISTURE.

- TO PREVENT THE SPREAD OF FIRE, KEEP CANDLES OR OTHER ITEMS WITH OPEN FLAMES AWAY FROM THIS PRODUCT AT ALL TIMES.

- **Do not place the TV and/or remote control in the following environments:**
 - Keep the product away from direct sunlight.
 - An area with high humidity such as a bathroom
 - Near any heat source such as stoves and other devices that produce heat.
 - Near kitchen counters or humidifiers where they can easily be exposed to steam or oil.
 - An area exposed to rain or wind.
 - Do not expose to dripping or splashing and do not place objects filled with liquids, such as vases, cups, etc. on or over the apparatus (e.g., on shelves above the unit).
 - Near flammable objects such as gasoline or candles, or expose the TV to direct air conditioning.
 - Do not install in excessively dusty places. Otherwise, this may result in fire, electric shock, combustion/explosion, malfunction or product deformation.

- **Ventilation**

- Install your TV where there is proper ventilation. Do not install in a confined space such as a bookcase.
- Do not install the product on a carpet or cushion.
- Do not block or cover the product with cloth or other materials while unit is plugged in.
- Take care not to touch the ventilation openings. When watching the TV for a long period, the ventilation openings may become hot.
- Protect the power cord from physical or mechanical abuse, such as being twisted, kinked, pinched, closed in a door, or walked upon. Pay particular attention to plugs, wall outlets, and the point where the cord exits the device.
- Do not move the TV whilst the Power cord is plugged in.
- Do not use a damaged or loosely fitting power cord.
- Be sure do grasp the plug when unplugging the power cord. Do not pull on the power cord to unplug the TV.
- Do not connect too many devices to the same AC power outlet as this could result in fire or electric shock.

- **Disconnecting the Device from the Main Power**

- The power plug is the disconnecting device. In case of an emergency, the power plug must remain readily accessible.
- Do not let your children climb or cling onto the TV. Otherwise, the TV may fall over, which may cause serious injury.
- **Outdoor Antenna Grounding** (Can differ by country):
 - If an outdoor antenna is installed, follow the precautions below. An outdoor antenna system should not be located in the vicinity of overhead power lines or other electric light or power circuits, or where it can come in contact with such power lines or circuits as death or serious injury can occur.
Be sure the antenna system is grounded to provide some protection against voltage surges and built-up static charges. Section 810 of the National Electrical Code (NEC) in the U.S.A. provides information with respect to proper grounding of the mast and supporting structure, grounding of the lead-in wire to an antenna discharge unit, size of grounding conductors, location of antenna discharge unit, connection to grounding electrodes and requirements for the grounding electrode. Antenna grounding according to the National Electrical Code, ANSI/NFPA 70

- **Grounding** (Except for devices which are not grounded.)
 - TV with a three-prong grounded AC plug must be connected to a three-prong grounded AC outlet. Ensure that you connect the earth ground wire to prevent possible electric shock.
 - Never touch this apparatus or antenna during a lightning storm. You may be electrocuted.
 - Make sure the power cord is connected securely to the TV and wall socket if not secured damage to the Plug and socket may occur and in extreme cases a fire may break out.
 - Do not insert metallic or inflammable objects into the product. If a foreign object is dropped into the product, unplug the power cord and contact the customer service.
 - Do not touch the end of the power cord while it is plugged in. You may be electrocuted.
- **If any of the following occur, unplug the product immediately and contact your local customer service.**
 - The product has been damaged.
 - If water or another substance enters the product (like an AC adapter, power cord, or TV).
 - If you smell smoke or other odors coming from the TV
 - When lightning storms or when unused for long periods of time.
Even the TV is turned off by remote control or button, AC power source is connected to the unit if not unplugged in.
 - Do not use high voltage electrical equipment near the TV (e.g., a bug zapper). This may result in product malfunction.
 - Do not attempt to modify this product in any way without written authorization from LG Electronics. Accidental fire or electric shock can occur. Contact your local customer service for service or repair. Unauthorized modification could void the user's authority to operate this product.

- Use only an authorized attachments / accessories approved by LG Electronics. Otherwise, this may result in fire, electric shock, malfunction, or product damage.
- Never disassemble the AC adapter or power cord. This may result in fire or electric shock.
- Handle the adapter carefully to avoid dropping or striking it. An impact could damage the adapter.
- To reduce the risk of fire or electrical shock, do not touch the TV with wet hands. If the power cord prongs are wet or covered with dust, dry the power plug completely or wipe dust off.
- **Batteries**
 - Store the accessories (battery, etc.) in a safe location out of the reach of children.
 - Do not short circuit, disassemble, or allow the batteries to overheat. Do not dispose of batteries in a fire. Batteries should not be exposed to excessive heat.
- **Moving**
 - When moving, make sure the product is turned off, unplugged, and all cables have been removed. It may take 2 or more people to carry larger TVs. Do not press or put stress on the front panel of the TV. Otherwise, this may result in product damage, fire hazard or injury.
- Keep the packing anti-moisture material or vinyl packing out of the reach of children.
- Do not allow an impact shock, any objects to fall into the product, and do not drop anything onto the screen.
- Do not press strongly upon the panel with a hand or a sharp object such as a nail, pencil, or pen, or make a scratch on it. It may cause damage to screen.
- **Cleaning**
 - When cleaning, unplug the power cord and wipe gently with a soft/dry cloth. Do not spray water or other liquids directly on the TV. Do not clean your TV with chemicals including glass cleaner, any type of air freshener, insecticide, lubricants, wax (car, industrial), abrasive, thinner, benzene, alcohol etc., which can damage the product and/or its panel. Otherwise, this may result in electric shock or product damage.

Preparing

- If the TV is turned on for the first time after it was shipped from the factory, initialization of the TV may take a few minutes.
- Image shown may differ from your TV.
- Your TV's OSD (On Screen Display) may differ slightly from that shown in this manual.
- The available menus and options may differ from the input source or product model that you are using.
- New features may be added to this TV in the future.
- The device must be easily accessed to a location outlet near the access. Some devices are not made by turning on / off button, turning off the device and unplugging the power cord.
- The items supplied with your product may vary depending on the model.
- Product specifications or contents of this manual may be changed without prior notice due to upgrade of product functions.

- For an optimal connection, HDMI cables and USB devices should have bezels less than 10 mm thick and 18 mm width. Use an extension cable that supports USB 2.0 if the USB cable or USB memory stick does not fit into your TV's USB port.

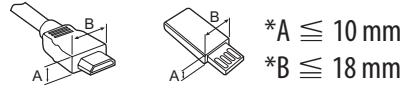

- Use a certified cable with the HDMI logo attached.
- If you do not use a certified HDMI cable, the screen may not display or a connection error may occur. (Recommended HDMI Cable Types)
 - High-Speed HDMI^{®/™} cable (3 m or less)
 - High-Speed HDMI^{®/™} cable with Ethernet (3 m or less)

Separate Purchase Wall Mounting Bracket

Separate purchase items can be changed or modified for quality improvement without any notification. Contact your dealer to buy these items. These devices only work with certain models.

The model name or design may be changed depending on the upgrade of product functions, manufacturer's circumstances or policies.

(Depending on model)

Make sure to use screws and wall mount bracket that meet the VESA standard. Standard dimensions for the wall mount kits are described in the following table.

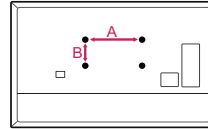

Magic Remote Control

(Depending on model)

AN-MR18BA

Check whether your TV model supports Bluetooth in the Wireless Module Specification to verify whether it can be used with the Magic Remote.

Model	OLED55/65B8* OLED55/65C8* OLED55/65E8*	OLED77C8*
VESA (A x B) (mm)	300 x 200	400 x 200
Standard screw	M6	M6
Number of screws	4	4
Wall mount bracket	OLW480B	OLW480B

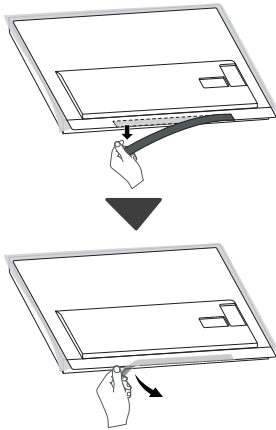

- Remove the bracket itself and the protective film inside it when installing the wall mount. (Only OLED55/65E8*)

Lifting and moving the TV

Please note the following advice to prevent the TV from being scratched or damaged and for safe transportation regardless of its type and size.

- It is recommended to move the TV in the box or packing material that the TV originally came in.
- Before moving or lifting the TV, disconnect the power cord and all cables.
- When holding the TV, the screen should face away from you to avoid damage.



- Hold the side and bottom of the TV frame firmly. Make sure not to hold the transparent part, speaker, or speaker grill area. (Not applicable for OLED55/65E8*)

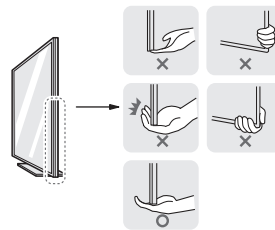

- When transporting a large TV, there should be at least 2 people.
- When transporting the TV by hand, hold the TV as shown in the following illustration.

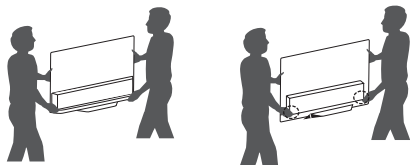

(Only OLED55/65E8*)

- Hold the side of the TV with one hand, and hold the bottom of the rear cover with the other. (Hold the rear cover when placing the TV on the floor. Holding the bottom glass may result in injury.) (Only OLED55/65E8*)
- When transporting the TV, do not expose the TV to jolts or excessive vibration.
- When transporting the TV, keep the TV upright, never turn the TV on its side or tilt towards the left or right.
- Do not apply excessive pressure to cause flexing / bending of frame chassis as it may damage screen.
- When handling the TV, be careful not to damage the protruding buttons.



- Avoid touching the screen at all times, as this may result in damage to the screen.
- Do not move the TV by holding the cable holders, as the cable holders may break, and injuries and damage to the TV may occur.
- When attaching the stand to the TV set, place the screen facing down on a cushioned table or flat surface to protect the screen from scratches.

Mounting on the Table

1 Lift and tilt the TV into its upright position on a table.

- Leave a 10 cm (minimum) space from the wall for proper ventilation.

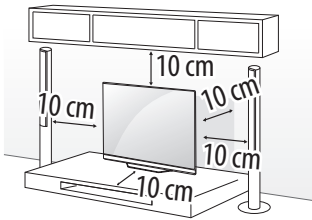

(Depending on model)

2 Connect the power cord to a wall outlet.

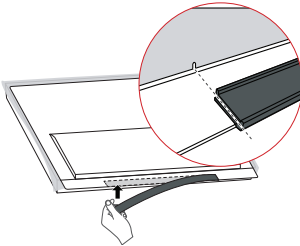

- If you install the TV on a stand instead of mounting it on a wall, make sure that the removed brackets are reattached at the bottom of the TV. (Only OLED55/65E8*)



- Do not apply foreign substances (oils, lubricants, etc.) to the screw parts when assembling the product. (Doing so may damage the product.)
- If you install the TV on a stand, you need to take actions to prevent the product from overturning. Otherwise, the product may fall over, which may cause injury.
- Do not use any unapproved items to ensure the safety and product life span.
- Any damage or injuries caused by using unapproved items are not covered by the warranty.
- Make sure that the screws are inserted correctly and fastened securely. (If they are not fastened securely enough, the TV may tilt forward after being installed.) Do not use too much force and over tighten the screws; otherwise screw may be damaged and not tighten correctly.

Securing TV to the Wall

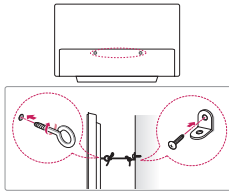

(Depending on model)

- 1 Insert and tighten the eye-bolts, or TV brackets and bolts on the back of the TV.
 - If there are bolts inserted at the eye-bolts position, remove the bolts first.
- 2 Mount the wall brackets with the bolts to the wall. Match the location of the wall bracket and the eye-bolts on the rear of the TV.
- 3 Connect the eye-bolts and wall brackets tightly with a sturdy rope. Make sure to keep the rope horizontal with the flat surface.
 - Use a platform or cabinet that is strong and large enough to support the TV securely.
 - Brackets, bolts and ropes are not provided. You can obtain additional accessories from your local dealer.

Mounting to the Wall

Attach an optional wall mount bracket at the rear of the TV carefully and install the wall mount bracket on a solid wall perpendicular to the floor. When you attach the TV to other building materials, please contact qualified personnel. LG recommends that wall mounting be performed by a qualified professional installer. We recommend the use of LG's wall mount bracket. LG's wall mount bracket is easy to move with cables connected. When you do not use LG's wall mount bracket, please use a wall mount bracket where the device is adequately secured to the wall with enough space to allow connectivity to external devices. It is advised to connect all the cables before installing fixed wall mounts.

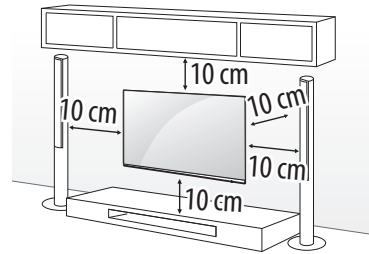

(Depending on model)



- Remove the stand before installing the TV on a wall mount by performing the stand attachment in reverse.
- For more information of screws and wall mount bracket, refer to the Separate purchase.
- If you intend to mount the product to a wall, attach VESA standard mounting interface (optional parts) to the back of the product. When you install the set to use the wall mounting bracket (optional parts), fix it carefully so as not to drop.
- When mounting a TV on the wall, make sure not to install the TV by hanging the power and signal cables on the back of the TV.
- Do not install this product on a wall if it could be exposed to oil or oil mist. This may damage the product and cause it to fall.

Connections

Connect various external devices to the TV and switch input modes to select an external device. For more information of external device's connection, refer to the manual provided with each device.

Antenna/Cable

Connect the TV to a wall antenna socket with an RF cable (75 Ω).

- Use a signal splitter to use more than 2 TVs.
- If the image quality is poor, install a signal amplifier properly to improve the image quality.
- If the image quality is poor with an antenna connected, try to realign the antenna in the correct direction.
- An antenna cable and converter are not supplied.
- For a location that is not supported with ULTRA HD broadcasting, this TV cannot receive ULTRA HD broadcasts directly. (Depending on model)

Satellite dish

Connect the TV to a satellite dish to a satellite socket with a satellite RF cable (75 Ω).
(Depending on model)

CI module

View the encrypted (pay) services in digital TV mode. (Depending on model)

- Check if the CI module is inserted into the PCMCIA card slot in the right direction. If the module is not inserted properly, this can cause damage to the TV and the PCMCIA card slot.
- If the TV does not display any video and audio when CI+ CAM is connected, please contact to the Terrestrial/Cable/Satellite Service Operator.



Other connections

Connect your TV to external devices. For the best picture and audio quality, connect the external device and the TV with the HDMI cable. Some separate cable is not provided.

HDMI

- Supported HDMI Audio format :
(Depending on model)
DTS (44.1 kHz, 48 kHz, 88.2 kHz, 96 kHz),
DTS HD (44.1 kHz, 48 kHz, 88.2 kHz, 96 kHz, 176.4 kHz, 192 kHz),
True HD (48 kHz),
Dolby Digital / Dolby Digital Plus (32 kHz, 44.1 kHz, 48 kHz),
PCM (32 kHz, 44.1 kHz, 48 kHz, 96 kHz, 192 kHz)

(Only UHD models)

-  →  →  (gear) → **Picture** → **Additional Settings** → **HDMI ULTRA HD Deep Colour**
 - On : Support 4K @ 50/60 Hz (4:4:4, 4:2:2, 4:2:0)
 - Off : Support 4K @ 50/60 Hz 8 bit (4:2:0)

If the device connected to Input Port also supports ULTRA HD Deep Colour, your picture may be clearer. However, if the device doesn't support it, it may not work properly. In that case, change the TV's **HDMI ULTRA HD Deep Colour** setting to off.

USB

Some USB Hubs may not work. If a USB device connected using a USB Hub is not detected, connect it to the USB port on the TV directly.

External Devices

Available external devices are: Blu-ray player, HD receivers, DVD players, VCRs, audio systems, USB storage devices, PC, gaming devices, and other external devices.

- The external device connection may differ from the model.
- Connect external devices to the TV regardless of the order of the TV port.
- If you record a TV program on a Blu-ray/DVD recorder or VCR, make sure to connect the TV signal input cable to the TV through a DVD recorder or VCR. For more information of recording, refer to the manual provided with the connected device.
- Refer to the external equipment's manual for operating instructions.
- If you connect a gaming device to the TV, use the cable supplied with the gaming device.
- In PC mode, there may be noise associated with the resolution, vertical pattern, contrast or brightness. If noise is present, change the PC output to another resolution, change the refresh rate to another rate or adjust the brightness and contrast on the PICTURE menu until the picture is clear.

- In PC mode, some resolution settings may not work properly depending on the graphics card.
- If ULTRA HD content is played on your PC, video or audio may become disrupted intermittently depending on your PC's performance. (Depending on model)
- When connecting via a wired LAN, it is recommended to use a CAT 7 cable. (Only when LAN port is provided.)

Remote RS-232C setup

To obtain the RS-232C external control setup information, please visit www.lg.com. Download and read the manual. (Depending on model)



- Do not drop the product or let it fall over when connecting external devices. Otherwise, this may result in injury or damage to the product.
- When connecting external devices such as video game consoles, make sure the connecting cables are long enough. Otherwise, the product may fall over, which may cause injury or damage the product.



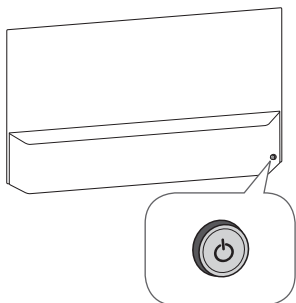

Using Button

You can simply operate the TV functions, using the button.





Adjusting the menu

When the TV is turned on, press the  button one time. You can adjust the Menu items using the button.

	Turns the power off.
	Accesses the settings menu.
	Clears on-screen displays and returns to TV viewing.
	Changes the input source.

Basic functions

	Power On (Press) Power Off ¹ (Press and hold)
	Volume Control
	Programmes Control

¹ All running apps will close, and any recording in progress will stop. (Depending on country)

Using Magic Remote Control

(Depending on model)

The descriptions in this manual are based on the buttons on the remote control. Please read this manual carefully and use the TV correctly.

When the message "Magic Remote battery is low. Please change the battery." is displayed, replace the battery.

To replace batteries, open the battery cover, replace batteries (1.5 V AA) matching the \oplus and \ominus ends to the label inside the compartment, and close the battery cover. Be sure to point the magic remote toward the remote control sensor on the TV. To remove the batteries, perform the installation actions in reverse.

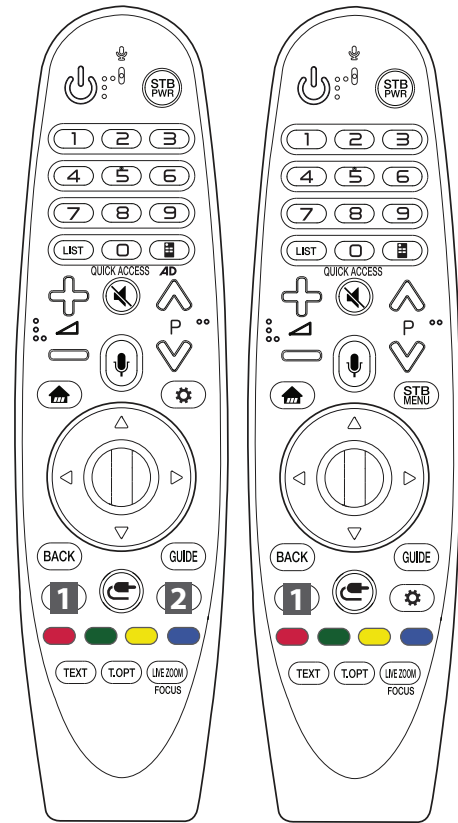

(Some buttons and services may not be provided depending on models or regions.)

* **To use the button, press and hold for more than 3 seconds.**

 **(POWER)** Turns the TV on or off.

STB PWR You can turn your set-top box on or off by adding the set-top box to the universal remote control for your TV.

Number buttons Enters numbers.

QUICK ACCESS* You can access apps or Live TV using the number buttons corresponding to the features.

LIST Accesses the saved programmes list.

 **(Screen Remote)** Displays the Screen Remote.

- Accesses the Universal Control Menu.

AD* Audio descriptions function will be enabled.

 Adjusts the volume level.

 **(MUTE)** Mutes all sounds.

 **(MUTE)** Accesses the **Accessibility** menu.

 **P** Scrolls through the saved programmes.

 **(Voice recognition)**

Network connection is required to use the voice recognition function.

Once the voice display bar is activated on the TV screen, press and hold the button and speak your command out loud.

 **(HOME)** Accesses the Home menu.

 **(HOME)** Shows the previous history.



 **(Q. Settings)** Accesses the Quick Settings.

 **(Q. Settings)** Displays the **All Settings** menu.

STB MENU Displays the set-top box Home menu.

- When you are not watching via a set-top box: the display changes to the set-top box screen.

 **Wheel (OK)** Press the center of the Wheel button to select a menu. You can change programmes by using the wheel button.

 **(up/down/left/right)** Press the up, down, left or right button to scroll the menu. If you press  buttons while the pointer is in use, the pointer will disappear from the screen and Magic Remote will operate like a general remote control. To display the pointer on the screen again, shake Magic Remote to the left and right.

BACK Returns to the previous level.

BACK* Clears on-screen displays and returns to last input viewing.

GUIDE Shows programme guide.

1, 2 Streaming Service buttons

Connects to the Video Streaming Service.

 **(INPUT)** Changes the input source.

 **(INPUT)** Displays a list of all the external inputs.

 These access special functions in some menus.

 **(Red Button)** Runs the record function.

Teletext buttons (TEXT, T.OPT) These buttons are used for teletext.

LIVE ZOOM By zooming in on the selected area, you can view it in full screen.

FOCUS* You can zoom in on the area where the remote control is pointed.

Registering Magic Remote Control

How to register the Magic Remote Control

To use the Magic Remote, first pair it with your TV.

- 1 Put batteries into the Magic Remote and turn the TV on.
 - 2 Point the Magic Remote at your TV and press the  **Wheel (OK)** on the remote control.
- * If the TV fails to register the Magic Remote, try again after turning the TV off and back on.

How to deregister the Magic Remote Control

Press the **BACK** and  (**HOME**) buttons at the same time, for five seconds, to unpair the Magic Remote with your TV.

- * Pressing and holding the **GUIDE** button will let you cancel and re-register Magic Remote at once.



- It is recommended that an Access Point (AP) be located more than 0.2 m away from the TV. If the AP is installed closer than 0.2 m, the Magic remote control may not perform as expected due to frequency interference.
- Do not mix new batteries with old batteries. This may cause the batteries to overheat and leak.
- Failure to match the correct polarities of the battery may cause the battery to burst or leak, resulting in fire, personal injury, or ambient pollution.
- This apparatus uses batteries. In your community there might be regulations that require you to dispose of these batteries properly due to environmental considerations. Please contact your local authorities for disposal or recycling information.
- Batteries inside or inside the product shall not be exposed to excessive heat such as sunshine, fire or the like.

Troubleshooting

Cannot control the TV with the remote control.

- Check the remote control sensor on the product and try again.
- Check if there is any obstacle between the product and the remote control.
- Check if the batteries are still working and properly installed (⊕ to ⊕, ⊖ to ⊖).

No image display and no sound is produced.

- Check if the product is turned on.
- Check if the power cord is connected to a wall outlet.
- Check if there is a problem in the wall outlet by connecting other products.

The TV turns off suddenly.

- Check the power control settings. The power supply may be interrupted.
- Check if the auto-off function is activated on the settings related time.
- If there is no signal while the TV is on, the TV will turn off automatically after 15 minutes of inactivity.

When connecting to the PC (HDMI), no signal is detected.

- Turn the TV off/on using the remote control.
- Reconnect the HDMI cable.
- Restart the PC with the TV on.

Abnormal Display

- If the product feels cold to the touch, there may be a small “flicker” when it is turned on. This is normal, there is nothing wrong with product.
- This panel is an advanced product that contains millions of pixels. You may see tiny black dots and/or brightly coloured dots (white, red, blue or green) at a size of 1 ppm on the panel. This does not indicate a malfunction and does not affect the performance and reliability of the product. This phenomenon also occurs in third-party products and is not subject to exchange or refund.
- You may find different brightness and colour of the panel depending on your viewing position(left/right/top/down). This phenomenon occurs due to the characteristic of the panel. It is not related with the product performance, and it is not malfunction.

Generated Sound

- “Cracking” noise: A cracking noise that occurs when watching or turning off the TV is generated by plastic thermal contraction due to temperature and humidity. This noise is common for products where thermal deformation is required.
- Electrical circuit humming/panel buzzing: A low level noise is generated from a high-speed switching circuit, which supplies a large amount of current to operate a product. It varies depending on the product. This generated sound does not affect the performance and reliability of the product.



- Make sure to wring any excess water or cleaner from the cloth.
- Do not spray water or cleaner directly onto the TV screen.
- Make sure to spray just enough of water or cleaner onto a dry cloth to wipe the screen.

Specifications

ENGLISH

Broadcasting Specifications				
	Digital TV			Analogue TV
Television system	DVB-T DVB-T2 ¹ DVB-C DVB-S/S2 ¹			PAL/SECAM, B/G, D/K, I SECAM L
Channel coverage (Band)	DVB-S/S2	DVB-C	DVB-T/T2	46 ~ 862 MHz
	950 ~ 2,150 MHz	46 ~ 890 MHz	VHF III : 174 ~ 230 MHz UHF IV : 470 ~ 606 MHz UHF V : 606 ~ 862 MHz S Band II : 230 ~ 300 MHz S Band III : 300 ~ 470 MHz	
Maximum number of storable programmes	6,000	3,000		
External antenna impedance	75 Ω			
CI Module (W x H x D)	100.0 mm x 55.0 mm x 5.0 mm			

1 Depending on country

Wireless module (LGSBWAC72) Specifications

Wireless LAN (IEEE 802.11a/b/g/n/ac)

Frequency Range	Output Power (Max.)
2,400 to 2,483.5 MHz	14 dBm
5,150 to 5,725 MHz	16.5 dBm
5,725 to 5,850 MHz (Not for EU)	11.5 dBm

Bluetooth

Frequency Range	Output Power (Max.)
2,400 to 2,483.5 MHz	8.5 dBm

As band channels can vary per country, the user cannot change or adjust the operating frequency. This product is configured for the regional frequency table.

For consideration of the user, this device should be installed and operated with a minimum distance of 20 cm between the device and the body.

* "IEEE 802.11ac" is not available in all countries.

Environment condition

Operating Temperature	0 °C to 40 °C
Operating Humidity	Less than 80 %
Storage Temperature	-20 °C to 60 °C
Storage Humidity	Less than 85 %

Open Source Software Notice Information

To obtain the source code under GPL, LGPL, MPL, and other open source licenses, that is contained in this product, please visit <http://opensource.lge.com>.

In addition to the source code, all referred license terms, warranty disclaimers and copyright notices are available for download.

LG Electronics will also provide open source code to you on CD-ROM for a charge covering the cost of performing such distribution (such as the cost of media, shipping, and handling) upon email request to opensource@lge.com.

This offer is valid for a period of three years after our last shipment of this product. This offer is valid to anyone in receipt of this information.

Licenses

Supported licenses may differ by model.



Important Information for Preventing Image Retention

OLED is a self-emissive technology, which brings many significant benefits to image quality and performance. As with any self-emitting display, it is possible for users of OLED TVs to experience temporary image retention under certain conditions, such as when displaying a static image on the screen for a long time. Even so, this phenomenon is rare under ordinary viewing conditions and is not a malfunction. Below sets forth helpful information you may refer to for using your OLED TV.

Examples of Images that may Cause Image Retention

- Still images or fixed images containing certain information that are displayed uninterrupted on the screen, such as channel numbers, station logos, program titles, news or movie subtitles, and headlines.
- Fixed menu or icons for video game consoles or broadcasting set-top boxes.
- Black bars shown on the left, right, top, or bottom of the screen, such as in images with a 4:3 or 21:9 ratio.

Recommended Measures for Preventing Image Retention

- Avoid watching a video displaying an image as listed above for extended periods of time.
- Adjust your TV settings as below when turning on a video exhibiting an image as listed above for extended periods of time.
 - **Picture** → **Picture Mode Settings** → **Picture Mode** → **Eco**
 - **Picture** → **Picture Mode Settings** → **OLED LIGHT** → Adjust to lower value
 - **Picture** → **OLED Panel Settings** → **Logo Luminance Adjustment** → **High**
- Turn off the menu bar of an external device, such as a set-top box, to prevent long-term display of the menu bar of such device. (Please refer to the manual of the applicable external device for instructions.)
- Adjust the settings as below when watching a video constantly showing black bars on the left, right, top or bottom, in order to remove the black bars.
 - **Picture** → **Aspect Ratio Settings** → **Aspect Ratio** → **Vertical Zoom** or **All-Direction Zoom**

Information on Functions Supporting Image Quality in Relation to Temporary Image Retention

- OLED TV offers a function called Pixel Refresher, which helps to prevent temporary image retention. This function can be operated automatically or manually.
- The auto feature will activate when the TV power is turned off, but only after the TV has been turned on for a cumulated total of four (4) hours or more, which need not be consecutive. Pixel Refresher will automatically run for several minutes after the screen is turned off. (Please note that failure to supply the AC power or disconnecting the power cord from the outlet will disable the auto feature.)
- To manually activate Pixel Refresher, you will have to select **Picture** → **OLED Panel Settings** → **Pixel Refresher** in the settings. Once manually activated, the function will run for approximately one (1) hour. During this time, a horizontal line may appear on the screen; however, this is not a malfunction.
- If Pixel Refresher has not been manually activated for a certain period of time, a pop-up window advising to activate this function will appear on the screen. Please follow the instructions set forth in the pop-up window.
- In addition to Pixel Refresher, there are other functions available for protecting the screen from image retention. For example, a function that automatically reduces the screen brightness level, in part or in whole, will be activated when a static image is displayed uninterrupted on the screen. Once the static image disappears, the brightness level will automatically return to the previous level. This function is an intended function, and not a malfunction.

ENGLISH



OWNER'S MANUAL

EXTERNAL CONTROL DEVICE SETUP

Please read this manual carefully before operating the set and retain it for future reference.

www.lg.com

KEY CODES

- This feature is not available for all models.

Code (Hexa)	Function	Note	Code (Hexa)	Function	Note
00	CH +, PR +	R/C Button	53	List	R/C Button
01	CH -, PR -	R/C Button	5B	Exit	R/C Button
02	Volume +	R/C Button	60	PIP(AD)	R/C Button
03	Volume -	R/C Button	61	Blue	R/C Button
06	> (Arrow Key / Right Key)	R/C Button	63	Yellow	R/C Button
07	< (Arrow Key / Left Key)	R/C Button	71	Green	R/C Button
08	Power	R/C Button	72	Red	R/C Button
09	Mute	R/C Button	79	Ratio / Aspect Ratio	R/C Button
0B	Input	R/C Button	91	AD (Audio Description)	R/C Button
0E	SLEEP	R/C Button	7A	User Guide	R/C Button
0F	TV, TV/RAD	R/C Button	7C	Smart / Home	R/C Button
10 - 19	* Number Key 0 - 9	R/C Button	7E	SIMPLINK	R/C Button
1A	Q.View / Flashback	R/C Button	8E	▶▶ (Forward)	R/C Button
1E	FAV (Favorite Channel)	R/C Button	8F	◀◀ (Rewind)	R/C Button
20	Text (Teletext)	R/C Button	AA	Info	R/C Button
21	T. Opt (Teletext Option)	R/C Button	AB	Program Guide	R/C Button
28	Return (BACK)	R/C Button	B0	▶ (Play)	R/C Button
30	AV (Audio / Video) Mode	R/C Button	B1	■ (Stop / File List)	R/C Button
39	Caption/Subtitle	R/C Button	BA	(Freeze / Slow Play / Pause)	R/C Button
40	∧ (Arrow Key / Cursor Up)	R/C Button	BB	Soccer	R/C Button
41	∨ (Arrow Key / Cursor Down)	R/C Button	BD	● (REC)	R/C Button
42	My Apps	R/C Button	DC	3D	R/C Button
43	Menu / Settings	R/C Button	99	AutoConfig	R/C Button
44	OK / Enter	R/C Button	9F	App / *	R/C Button
45	Q.Menu	R/C Button	9B	TV/PC	R/C Button
4C	List, - (ATSC Only)	R/C Button			

* Key code 4C (0x4C) is available on ATSC/ISDB models which use major/minor channel.
(For South Korea, Japan, North America, Latin America except Colombia models)

EXTERNAL CONTROL DEVICE SETUP

- Image shown may differ from your TV.

Connect the USB to Serial converter/RS-232C input jack to an external control device (such as a computer or an A/V control system) to control the product's functions externally.

Note: The type of control port on the TV can be different between model series.

- * Please be advised that not all models support this type of connectivity.
- * Cable is not provided.

USB to Serial converter with USB Cable

USB Type

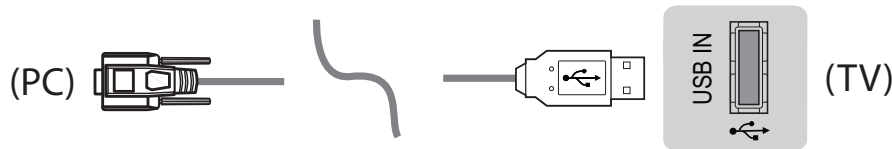

- LGTV supports PL2303 chip-based (Vendor ID : 0x0557, Product ID : 0x2008) USB to serial converter which is not made nor provided by LG.
- It can be purchased from computer stores that carry accessories for IT support professionals.

RS-232C With RS232C Cable

DE9 (D-Sub 9pin) Type

- You need to purchase the RS-232C (DE9, D-Sub 9pin female-to-female type) to RS-232C cable required for the connection between the PC and the TV, which is specified in the manual.



The connection interface may differ from your TV.

ENGLISH

Phone jack Type

- You need to purchase the phone-jack to RS-232 cable required for the connection between the PC and the TV, which is specified in the manual.
- * For other models, connect to the USB port.
- * The connection interface may differ from your TV.

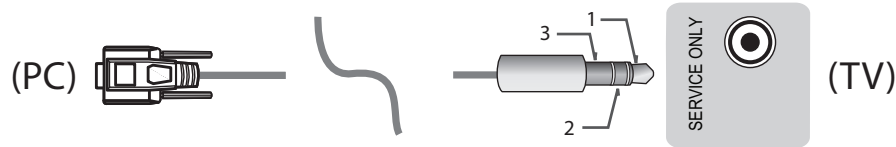

- or

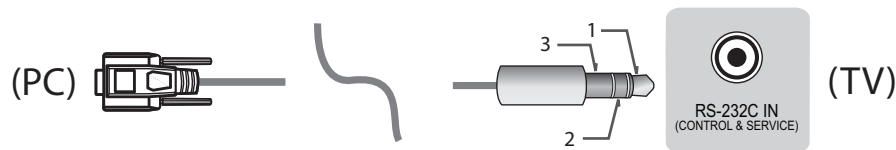

Customer Computer

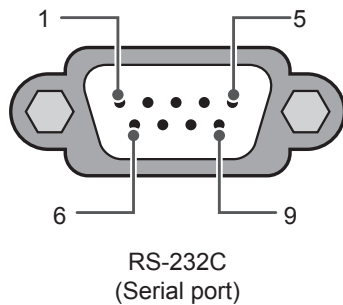

RS-232C configurations

3-Wire Configurations(Not standard)

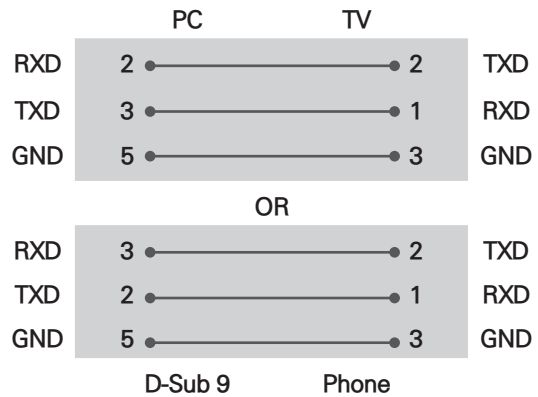

Set ID

For Set ID number, see "Real Data Mapping" on p.6

1. Press **SETTINGS** to access the main menus.
2. Press the Navigation buttons to scroll to (***General** → **About this TV or OPTION**) and press **OK**.
3. Press the Navigation buttons to scroll to **SET ID** and press **OK**.
4. Scroll left or right to select a set ID number and select **CLOSE**. The adjustment range is 1-99.
5. When you are finished, press **EXIT**.
* (Depending on model)

Communication Parameters

- Baud rate : 9600 bps (UART)
- Data length : 8 bits
- Parity : None
- Stop bit : 1 bit
- Communication code : ASCII code
- Use a crossed (reverse) cable.

Command reference list

(Depending on model)

	COMMAND1	COMMAND2	DATA (Hexadecimal)		COMMAND1	COMMAND2	DATA (Hexadecimal)
01. Power*	k	a	00 to 01	15. Balance	k	t	00 to 64
02. Aspect Ratio	k	c	(p.7)	16. Color (Colour) Temperature	x	u	00 to 64
03. Screen Mute	k	d	(p.7)	17. ISM Method (Only Plasma TV)	j	p	(p.8)
04. Volume Mute	k	e	00 to 01	18. Equalizer	j	v	(p.8)
05. Volume Control	k	f	00 to 64	19. Energy Saving	j	q	00 to 05
06. Contrast	k	g	00 to 64	20. Tune Command	m	a	(p.9)
07. Brightness	k	h	00 to 64	21. Channel (Programme) Add/Del(Skip)	m	b	00 to 01
08. Color/ Colour	k	i	00 to 64	22. Key	m	c	Key Codes
09. Tint	k	j	00 to 64	23. Control Backlight, Control Panel Light	m	g	00 to 64
10. Sharpness	k	k	00 to 32	24. Input select (Main)	x	b	(p.11)
11. OSD Select	k	l	00 to 01	25. 3D (Only 3D models)	x	t	(p.11)
12. Remote Control Lock Mode	k	m	00 to 01	26. Extended 3D (Only 3D models)	x	v	(p.11)
13. Treble	k	r	00 to 64	27. Auto Configure	j	u	(p.12)
14. Bass	k	s	00 to 64				

* Note: During playing or recording media, all commands except Power (ka) and Key (mc) are not executed and treated as NG.
With RS232C cable, TV can communicate "ka command" in power-on or power-off status. but with USB-to-Serial converter cable, the command works only if TV is on.

Transmission / Receiving Protocol

Transmission

[Command1][Command2][][Set ID][][Data][Cr]

[Command 1] : First command to control the TV. (j, k, m or x)

[Command 2] : Second command to control the TV.

[Set ID] : You can adjust the [Set ID] to choose desired monitor ID number in option menu.
Adjustment range in TV is 1 to 99. If [Set ID] value is selected to '0', every connected set can be controlled.
* [Set ID] is indicated as decimal (1 to 99) on menu and as Hexadecimal (0x00 to 0x63) on transmission/receiving protocol.

[DATA] : To transmit command data (hexadecimal). Transmit 'FF' data to read status of command.

[Cr] : Carriage Return - ASCII code '0x0D'

[] : Space - ASCII code '0x20'

OK Acknowledgement

[Command2][][Set ID][][OK][Data][x]

* The set transmits ACK (acknowledgement) based on this format when receiving normal data. At this time, if the data is data read mode, it indicates present status data. If the data is data write mode, it returns the data of the PC computer.

Error Acknowledgement

[Command2][][Set ID][][NG][Data][x]

* The set transmits ACK (acknowledgement) based on this format when receiving abnormal data from non-viable functions or communication errors.

Data 00: Illegal Code

Real data mapping (Hexadecimal to Decimal)

* When you enter the [data] in hexadecimal, refer to following conversion table.

* Channel Tune (ma) Command uses two-byte hexadecimal value([data]) to select channel number.

00 : Step 0	32 : Step 50 (Set ID 50)	FE : Step 254
01 : Step 1 (Set ID 1)	33 : Step 51 (Set ID 51)	FF : Step 255
...
0A : Step 10 (Set ID 10)	63 : Step 99 (Set ID 99)	01 00 : Step 256
...
0F : Step 15 (Set ID 15)	C7 : Step 199	27 0E : Step 9998
10 : Step 16 (Set ID 16)	C8 : Step 200	27 0F : Step 9999
...

* Commands may work differently depending on model and signal.

01. Power (Command: k a)

- ▶ To control Power *On or Off of the set.

Transmission [k][a][][Set ID][][Data][Cr]

Data 00 : Power Off 01 : *Power On

Ack [a][][Set ID][][OK/NG][Data][x]

- ▶ To Show TV is Power On or *Off

Transmission [k][a][][Set ID][][FF][Cr]

Ack [a][][Set ID][][OK][Data][x]

* Similarly, if other functions transmit 'FF' data based on this format, Acknowledgement feedback presents status about each function.

02. Aspect Ratio (Command: k c) (Main Picture Size)

- ▶ To adjust the screen format. (Main picture format) You can also adjust the screen format using the Aspect Ratio in the Q.MENU. or PICTURE menu.

Transmission [k][c][][Set ID][][Data][Cr]

Data 01 : Normal screen 07 : 14:9
(4:3) (Europe, Colombia, Mid-East,
02 : Wide screen Asia except South Korea and
(16:9) Japan)
04 : Zoom 09 : * Just Scan
05 : Zoom 2 0B : Full Wide
(Latin America (Europe, Colombia, Mid-
except Colombia East, Asia except South
Only) Korea and Japan)
06 : Set by Program/ 10 to 1F : Cinema Zoom 1
Original to 16

Ack [c][][Set ID][][OK/NG][Data][x]

- * Using the PC input, you select either 16:9 or 4:3 screen aspect ratio.
- * In DTV/HDMI/Component mode (high-definition), Just Scan is available.
- * Full wide mode may work differently based on model and is supported for DTV fully, and ATV, AV partially.

03. Screen Mute (Command: k d)

- ▶ To select screen mute on/off.

Transmission [k][d][][Set ID][][Data][Cr]

Data 00 : Screen mute off (Picture on)
Video mute off
01 : Screen mute on (Picture off)
10 : Video mute on

Ack [d][][Set ID][][OK/NG][Data][x]

* In case of video mute on only, TV will display On Screen Display(OSD). But, in case of Screen mute on, TV will not display OSD.

04. Volume Mute (Command: k e)

- ▶ To control volume mute on/off.
You can also adjust mute using the MUTE button on remote control.

Transmission [k][e][][Set ID][][Data][Cr]

Data 00 : Volume mute on (Volume off)
01 : Volume mute off (Volume on)

Ack [e][][Set ID][][OK/NG][Data][x]

05. Volume Control (Command: k f)

- ▶ To adjust volume.
You can also adjust volume with the volume buttons on remote control.

Transmission [k][f][][Set ID][][Data][Cr]

Data Min : 00 to Max : 64

Ack [f][][Set ID][][OK/NG][Data][x]

06. Contrast (Command: k g)

- ▶ To adjust screen contrast.
You can also adjust contrast in the PICTURE menu.

Transmission [k][g][][Set ID][][Data][Cr]

Data Min : 00 to Max : 64

Ack [g][][Set ID][][OK/NG][Data][x]

07. Brightness (Command: k h)

- ▶ To adjust screen brightness.
You can also adjust brightness in the PICTURE menu.

Transmission [k][h][][Set ID][][Data][Cr]

Data Min : 00 to Max : 64

Ack [h][][Set ID][][OK/NG][Data][x]

08. Color/Colour (Command: k i)

- ▶ To adjust the screen Color(Colour).
You can also adjust colour in the PICTURE menu.

Transmission [k][i][][Set ID][][Data][Cr]

1	0	0	5th Band	1	0	1	0	0	20(decimal)
---	---	---	----------	---	---	---	---	---	-------------

Acknowledgement [v][][Set ID][][OK/NG][Data][x]

* It depends on model, and can adjust when sound mode is EQ adjustable value.

19. Energy Saving (Command: j q)

► To reduce the power consumption of the TV. You can also adjust Energy Saving in PICTURE menu.

Transmission [j][q][][Set ID][][Data][Cr]

Data

- 00 : Off
- 01 : Minimum
- 02 : Medium
- 03 : Maximum
- 04 : Auto (For LCD TV / LED TV) / Intelligent sensor (For PDP TV)
- 05 : Screen off

* (Depending on model)

Ack [q][][Set ID][][OK/NG][Data][x]

20. Tune Command (Command: m a)

* This command may work differently depending on model and signal.

• For Europe, Mid-East, Colombia, Asia except South Korea and Japan Model

► Select channel to following physical number.

Transmission [m][a][][Set ID][][Data 00][][Data 01][][Data 02][Cr]

* Analog Antenna/Cable

[Data 00][Data 01] Channel Data
Data 00 : High byte channel data
Data 01 : Low byte channel data
- 00 00 ~ 00 C7 (Decimal : 0 ~ 199)

Data 02 : Input Source (Analog)
- 00 : Antenna TV (ATV)
- 80 : Cable TV (CATV)

* Digital Antenna/Cable/Satellite

[Data 00][Data 01]: Channel Data
Data 00 : High Channel data
Data 01 : Low Channel data
- 00 00 ~ 27 0F (Decimal: 0 ~ 9999)

Data 02 : Input Source (Digital)
- 10 : Antenna TV (DTV)
- 20 : Antenna Radio (Radio)
- 40 : Satellite TV (SDTV)
- 50 : Satellite Radio (S-Radio)
- 90 : Cable TV (CADTV)
- a0 : Cable Radio (CA-Radio)

* Tune Command Examples:

1. Tune to the Analog antenna (PAL) Channel 10.

Set ID = All = 00
Data 00 & 01 = Channel Data is 10 = 00 0a
Data 02 = Analog Antenna TV = 00
Result = **ma 00 00 0a 00**

2. Tune to the digital antenna (DVB-T) Channel 01.

Set ID = All = 00
Data 00 & 01 = Channel Data is 1 = 00 01
Data 02 = Digital Antenna TV = 10
Result = **ma 00 00 01 10**

3. Tune to the satellite (DVB-S) Channel 1000.

Set ID = All = 00
Data 00 & 01 = Channel Data is 1000 = 03 E8
Data 02 = Digital Satellite TV = 40
Result = **ma 00 03 E8 40**

Ack [a][][Set ID][][OK][Data 00][Data 01]

[Data 02][x][a][][Set ID][][NG][Data 00][x]

• For South Korea, North/Latin America except Colombia Model

► To tune channel to following physical/major/minor number.

Transmission [m][a][][0][][Data00][][Data01]

[][Data02][][Data03][][Data04][][Data05][Cr]

Digital channels have a Physical, Major, and Minor channel number. The Physical number is the actual digital channel number, the Major is the number that the channel should be mapped to, and the Minor is the sub-channel. Since the ATSC tuner automatically maps the channel from the Major / Minor number, the Physical number is not required when sending a command in Digital.

* Analog Antenna/Cable

Data 00 : Physical Channel Number
- Antenna (ATV) : 02~45 (Decimal: 2 ~ 69)
- Cable (CATV) : 01, 0E~7D (Decimal : 1, 14~125)

[Data 01 ~ 04]: Major/Minor Channel Number

Data 01 & 02: xx (Don't care)

Data 03 & 04: xx (Don't care)

Data 05: Input Source (Analog)

- 00 : Antenna TV (ATV)

- 01 : Cable TV (CATV)

* Digital Antenna/Cable

Data 00 : xx (Don't care)

[Data 01][Data 02]: Major Channel Number

Data 01 : High byte Channel Data

Data 02 : Low byte Channel Data

- 00 01 ~ 27 0F (Decimal: 1 ~ 9999)

[Data 03][Data 04]: Minor Channel Number

Data 03 : High byte Channel Data

Data 04 : Low byte Channel Data

Data 05 : Input Source (Digital)

- 02 : Antenna TV (DTV) – Use Physical Channel Number

- 06 : Cable TV (CADTV) – Use Physical Channel

Number
 - 22 : Antenna TV (DTV) – Don't Use Physical Channel Number
 - 26 : Cable TV (CADTV) - Don't Use Physical Channel Number
 - 46 : Cable TV (CADTV) – Use Major Channel Number Only (One Part Channel)
 Two bytes are available for each major and minor channel data, but usually the low byte is used alone (high byte is 0).

* Tune Command Examples:

1. Tune to the Analog cable (NTSC) channel 35.

Set ID = All = 00
 Data 00 = Channel Data is 35 = 23
 Data 01 & 02 = No Major = 00 00
 Data 03 & 04 = No Minor = 00 00
 Data 05 = Analog Cable TV = 01
 Total = **ma 00 23 00 00 00 00 01**

2. Tune to the digital antenna (ATSC) channel 30-3.

Set ID = All = 00
 Data 00 = Don't know Physical = 00
 Data 01 & 02 = Major is 30 = 00 1E
 Data 03 & 04 = Minor is 3 = 00 03
 Data 05 = Digital Antenna TV = 22
 Total = **ma 00 00 00 1E 00 03 22**

Ack [a][][Set ID][][OK][Data 00][Data 01]
 [Data 02][Data 03][Data 04][Data 05]
 [x][a][][Set ID][][NG][Data 00][x]

• For Japan Model

▶ To tune channel to following physical/major/minor number.

Transmission [m][a][][0][][Data00][][Data01]
 [][Data02][][Data03][][Data04][][Data05][Cr]

* Digital Antenna/Satellite

Data 00: xx (Don't care)

[Data 01][Data 02]: Major Channel Number

Data 01: High byte Channel Data

Data 02: Low byte Channel Data

- 00 01 ~ 27 0F (Decimal: 1 ~ 9999)

[Data 03][Data 04]: Minor/Branch Channel Number
 (Don't care in Satellite)

Data 03: High byte Channel Data

Data 04: Low byte Channel Data

Data 05 : Input Source (Digital/Satellite for Japan)

- 02 : Antenna TV (DTV)

- 07 : BS (Broadcasting Satellite)

- 08 : CS1 (Communication Satellite 1)

- 09 : CS2 (Communication Satellite 2)

* Tune Command Examples:

1 Tune to the digital antenna (ISDB-T) channel 17-1.

Set ID = All = 00
 Data 00 = Don't know Physical = 00
 Data 01 & 02 = Major is 17 = 00 11
 Data 03 & 04 = Minor/Branch is 1 = 00 01

Data 05 = Digital Antenna TV = 02
 Total = **ma 00 00 00 11 00 01 02**

2. Tune to the BS (ISDB-BS) channel 30.

Set ID = All = 00
 Data 00 = Don't know Physical = 00
 Data 01 & 02 = Major is 30 = 00 1E
 Data 03 & 04 = Don't Care = 00 00
 Data 05 = Digital BS TV = 07
 Total = **ma 00 00 00 1E 00 00 07**

* This feature is varied based on the model.

Ack [a][][Set ID][][OK][Data 00][Data 01]
 [Data 02][Data 03][Data 04][Data 05]
 [x][a][][Set ID][][NG][Data 00][x]

21. Channel(Programme) Add/Del(Skip)
 (Command: m b)

▶ To skip current channel(programme) for next time.

Transmission [m][b][][Set ID][][Data][Cr]

Data 00 : Del(ATSC,ISDB)/Skip(DVB) 01 : Add

Ack [b][][Set ID][][OK/NG][Data][x]

* Set the saved channel status to del(ATSC, ISDB)/skip(DVB) or add.

22. Key (Command: m c)

▶ To send IR remote key code.

Transmission [m][c][][Set ID][][Data][Cr]

Data Key code - p.2.

Ack [c][][Set ID][][OK/NG][Data][x]

23. Control Backlight (Command: m g)

• For LCD TV / LED TV

▶ To control the backlight.

Transmission [m][g][][Set ID][][Data][Cr]

Data Min : 00 to Max : 64

Ack [g][][Set ID][][OK/NG][Data][x]

Control Panel Light (Command: m g)

• For Plasma TV

▶ To control the panel light.

Transmission [m][g][][Set ID][][Data][Cr]

Data Min : 00 to Max : 64

Ack [g][][Set ID][][OK/NG][Data][x]

24. Input select (Command: x b) (Main Picture Input)

- ▶ To select input source for main picture.

Transmission [x][b][][Set ID][][Data][Cr]

Data

00 : DTV 01 : CADTV
 02 : Satellite DTV 10 : ATV
 ISDB-BS (Japan)
 03 : ISDB-CS1 (Japan)
 04 : ISDB-CS2 (Japan)
 11 : CATV

 20 : AV or AV1 21 : AV2
 40 : Component1 41 : Component2
 60 : RGB

 90 : HDMI1 91 : HDMI2
 92 : HDMI3 93 : HDMI4

Ack [b][][Set ID][][OK/NG][Data][x]

- * This function depends on model and signal.

25. 3D(Command: x t) (only 3D models) (Depending on model)

- ▶ To change 3D mode for TV.

Transmission [x][t][][Set ID][][Data 00][][Data 01]
 [][Data 02][][Data 03][Cr]

- * (Depending on model)

Data Structure

[Data 00] 00 : 3D On
 01 : 3D Off
 02 : 3D to 2D
 03 : 2D to 3D

 [Data 01] 00 : Top and Bottom
 01 : Side by Side
 02 : Check Board
 03 : Frame Sequential
 04 : Column interleaving
 05 : Row interleaving

 [Data 02] 00 : Right to Left
 01 : Left to Right

 [Data 03] 3D Effect(3D Depth): Min : 00 - Max : 14
 (*transmit by Hexadecimal code)

- * [Data 02], [Data 03] functions depend on model and signal.
- * If [Data 00] is 00 (3D On), [Data 03] has no meaning.
- * If [Data 00] is 01 (3D off) or 02 (3D to 2D), [Data 01], [Data 02] and [Data 03] have no meaning.
- * If [Data 00] is 03 (2D to 3D), [Data 01] and [Data 02] have no meaning.
- * If [Data 00] is 00 (3D On) or 03 (2D to 3D), [Data 03] works when 3D Mode (Genre) is manual only.
- * All 3D pattern options ([Data 01]) may not be available according to broadcasting/video signal.

[Data 00]	[Data 01]	[Data 02]	[Data 03]
-----------	-----------	-----------	-----------

00	O	O	O
01	X	X	X
02	X	X	X
03	X	O	O

X : don't care

Ack [t][][Set ID][][OK][Data00][Data01][Data02]
 [Data03][x]
 [t][][Set ID][][NG][Data00][x]

26. Extended 3D(Command: x v) (only 3D models) (Depending on model)

- ▶ To change 3D option for TV.

Transmission [x][v][][Set ID][][Data 00][
 [Data 01][Cr]

[Data 00] 3D option

00 : 3D Picture Correction
 01 : 3D Depth (3D Mode is Manual Only)
 02 : 3D Viewpoint
 06 : 3D Color Correction
 07 : 3D Sound Zooming
 08 : Normal Image View
 09 : 3D Mode (Genre)

[Data 01] It has own range for each 3D option determined by [Data 00].

1) When [Data 00] is 00
 00 : Right to Left
 01 : Left to Right

2) When [Data 00] is 01, 02
 Data Min: 0 - Max: 14 (*transmit by Hexadecimal code)

Data value range(0 - 20) converts Viewpoint range (-10 - +10) automatically (Depending on model)
 * This option works when 3D Mode (Genre) is manual only.

3) When [Data 00] is 06, 07
 00 : Off
 01 : On

4) When [Data 00] is 08
 00 : Revert to 3D video from 3D-to-2D converted 2D video
 01 : Change 3D video to 2D video, except 2D-to-3D video

* If conversion condition doesn't meet, command is treated as NG.

5) When [Data 00] is 09

00 : Standard 01 : Sport
 02 : Cinema 03 : Extreme
 04 : Manual 05 : Auto

Ack [v][][Set ID][][OK][Data00][Data01][x]
 [v][][Set ID][][NG][Data00][x]

27. Auto Configure (Command: j u) (Depending on model)

- ▶ To adjust picture position and minimize image shaking automatically. It works only in RGB (PC) mode.

Transmission [j][u][][Set ID][][Data][Cr]

Data 01 : Run Auto Configure

Ack [u][][Set ID][][OK/NG][Data][x]