



OWNER'S MANUAL

Safety and Reference

OLED TV

Please read this manual carefully before operating your set and retain it for future reference.



* M F L 7 1 7 1 6 8 1 2 *

(2010-REV00)

www.lg.com

Copyright © 2020 LG Electronics Inc. All Rights Reserved.

Warning! Safety Instructions



CAUTION : TO REDUCE THE RISK OF ELECTRIC SHOCK, DO NOT REMOVE COVER (OR BACK). NO USER-SERVICEABLE PARTS INSIDE. REFER TO QUALIFIED SERVICE PERSONNEL.

 This symbol is intended to alert the user to the presence of uninsulated "dangerous voltage" within the product's enclosure that may be of sufficient magnitude to constitute a risk of electric shock to persons.

 This symbol is intended to alert the user to the presence of important operating and maintenance (servicing) instructions in the literature accompanying the appliance.

WARNING : TO REDUCE THE RISK OF FIRE AND ELECTRIC SHOCK, DO NOT EXPOSE THIS PRODUCT TO RAIN OR MOISTURE.

- TO PREVENT THE SPREAD OF FIRE, KEEP CANDLES OR OTHER ITEMS WITH OPEN FLAMES AWAY FROM THIS PRODUCT AT ALL TIMES.
 - **Do not place the TV and/or remote control in the following environments:**
 - Keep the product away from direct sunlight.
 - An area with high humidity such as a bathroom.
 - Near any heat source such as stoves and other devices that produce heat.
 - Near kitchen counters or humidifiers where they can easily be exposed to steam or oil.
 - An area exposed to rain or wind.
 - Do not expose to dripping or splashing and do not place objects filled with liquids, such as vases, cups, etc. on or over the apparatus (e.g., on shelves above the unit).
 - Near flammable objects such as gasoline or candles, or expose the TV to direct air conditioning.
 - Do not install in excessively dusty places.
- Otherwise, this may result in fire, electric shock, combustion/explosion, malfunction or product deformation.

• Ventilation

- Install your TV where there is proper ventilation. Do not install in a confined space such as a bookcase.
- Do not install the product on a carpet or cushion.
- Do not block or cover the product with cloth or other materials while unit is plugged in.
- Take care not to touch the ventilation openings. When watching the TV for a long period, the ventilation openings may become hot.
- Protect the power cord from physical or mechanical abuse, such as being twisted, kinked, pinched, closed in a door, or walked upon. Pay particular attention to plugs, wall outlets, and the point where the cord exits the device.
- Do not move the TV whilst the Power cord is plugged in.
- Do not use a damaged or loosely fitting power cord.
- Be sure to grasp the plug when unplugging the power cord. Do not pull on the power cord to unplug the TV.
- Do not connect too many devices to the same AC power outlet as this could result in fire or electric shock.
- **Disconnecting the Device from the Main Power**
 - The power plug is the disconnecting device. In case of an emergency, the power plug must remain readily accessible.
- Do not let your children climb or cling onto the TV. Otherwise, the TV may fall over, which may cause serious injury.
- **Outdoor Antenna Grounding** (Can differ by country):
 - If an outdoor antenna is installed, follow the precautions below. An outdoor antenna system should not be located in the vicinity of overhead power lines or other electric light or power circuits, or where it can come in contact with such power lines or circuits as death or serious injury can occur.

- **Grounding** (Except for devices which are not grounded.)
 - TV with a three-prong grounded AC plug must be connected to a three-prong grounded AC outlet. Ensure that you connect the earth ground wire to prevent possible electric shock.
 - Never touch this apparatus or antenna during a lightning storm. You may be electrocuted.
 - Make sure the power cord is connected securely to the TV and wall socket if not secured damage to the Plug and socket may occur and in extreme cases a fire may break out.
 - Do not insert metallic or inflammable objects into the product. If a foreign object is dropped into the product, unplug the power cord and contact the customer service.
 - Do not touch the end of the power cord while it is plugged in. You may be electrocuted.
 - **If any of the following occur, unplug the product immediately and contact your local customer service.**
 - The product has been damaged.
 - If water or another substance enters the product (like an AC adapter, power cord, or TV).
 - If you smell smoke or other odors coming from the TV.
 - When lightning storms or when unused for long periods of time.

Even if the TV is turned off by the remote control or power button, AC power source is still connected to the unit if it is not unplugged.
 - Do not use high voltage electrical equipment near the TV (e.g., a bug zapper). This may result in product malfunction.
 - Do not attempt to modify this product in any way without written authorisation from LG Electronics. Accidental fire or electric shock can occur. Contact your local customer service for service or repair. Unauthorised modification could void the user's authority to operate this product.
 - Use only an authorised attachments / accessories approved by LG Electronics. Otherwise, this may result in fire, electric shock, malfunction, or product damage.
 - Never disassemble the AC adapter or power cord. This may result in fire or electric shock.
 - Handle the adapter carefully to avoid dropping or striking it. An impact could damage the adapter.
 - To reduce the risk of fire or electrical shock, do not touch the TV with wet hands. If the power cord prongs are wet or covered with dust, dry the power plug completely or wipe dust off.
- **Batteries**
 - Store the accessories (battery, etc.) in a safe location out of the reach of children.
 - Do not short circuit, disassemble, or allow the batteries to overheat. Do not dispose of batteries in a fire. Batteries should not be exposed to excessive heat.
 - **Moving**
 - When moving, make sure the product is turned off, unplugged, and all cables have been removed. It may take 2 or more people to carry larger TVs. Do not press or put stress on the front panel of the TV. Otherwise, this may result in product damage, fire hazard or injury.
 - Keep the packing anti-moisture material or vinyl packing out of the reach of children.
 - Do not allow an impact shock, any objects to fall into the product, and do not drop anything onto the screen.
 - Do not press strongly upon the panel with a hand or a sharp object such as a nail, pencil, or pen, or make a scratch on it. It may cause damage to screen.
 - **Cleaning**
 - When cleaning, unplug the power cord and wipe gently with a soft/dry cloth. Do not spray water or other liquids directly on the TV. Do not clean your TV with chemicals including glass cleaner, any type of air freshener, insecticide, lubricants, wax (car, industrial), abrasive, thinner, benzene, alcohol etc., which can damage the product and/or its panel. Otherwise, this may result in electric shock or product damage.

Preparing

- If the TV is turned on for the first time after it was shipped from the factory, initialisation of the TV may take a few minutes.
- Image shown may differ from your TV.
- Your TV's OSD (On Screen Display) may differ slightly from that shown in this manual.
- The available menus and options may differ from the input source or product model that you are using.
- New features may be added to this TV in the future.
- The device must be easily accessed to a location outlet near the access. Some devices are not made by turning on / off button, turning off the device and unplugging the power cord.
- The items supplied with your product may vary depending on the model.
- Product specifications or contents of this manual may be changed without prior notice due to upgrade of product functions.
- For an optimal connection, HDMI cables and USB devices should have bezels less than 10 mm thick and 18 mm width. Use an extension cable that supports USB 2.0 if the USB cable or USB memory stick does not fit into your TV's USB port.

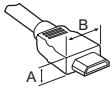

* A ≤ 10 mm

* B ≤ 18 mm

- Use a certified cable with the HDMI logo attached.
- If you do not use a certified HDMI cable, the screen may not display or a connection error may occur.
- Recommended HDMI Cable Types
 - Ultra High Speed HDMI[®]/TM Cable (3 m or less)

Separate Purchase

Separate purchase items can be changed or modified for quality improvement without any notification. Contact your dealer to buy these items. These devices only work with certain models.

The model name or design may be changed depending on the upgrade of product functions, manufacturer's circumstances or policies.

Magic Remote Control

AN-MR18HA

Check whether your TV model supports Bluetooth in the Wireless Module Specification to verify whether it can be used with the Magic Remote.

Wall Mounting Bracket

Make sure to use screws and wall mount bracket that meet the VESA standard. Standard dimensions for the wall mount kits are described in the following table.

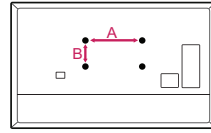

Model	48ES96*
VESA (A x B) (mm)	300 x 200
Standard screw	M6
Number of screws	4
Wall mount bracket	OLW480B

Lifting and moving the TV

Please note the following advice to prevent the TV from being scratched or damaged and for safe transportation regardless of its type and size.

- It is recommended to move the TV in the box or packing material that the TV originally came in.
- Before moving or lifting the TV, disconnect the power cord and all cables.
- When holding the TV, the screen should face away from you to avoid damage.



- Hold the top and bottom of the TV frame firmly. Make sure not to hold the transparent part, speaker, or speaker grill area.

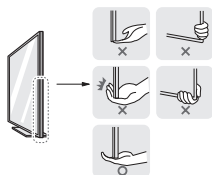

- When transporting a large TV, there should be at least 2 people.
- When transporting the TV by hand, hold the TV as shown in the following illustration.

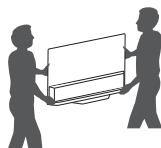

- When transporting the TV, do not expose the TV to jolts or excessive vibration.
- When transporting the TV, keep the TV upright, never turn the TV on its side or tilt towards the left or right.
- Do not apply excessive pressure to cause flexing / bending of frame chassis as it may damage the screen.
- When handling the TV, be careful not to damage the protruding buttons.



- Avoid touching the screen at all times, as this may result in damage to the screen.
- When attaching the stand to the TV set, place the screen facing down on a cushioned table or flat surface to protect the screen from scratches.

Mounting on a Table

- 1 Lift and tilt the TV into its upright position on a table.
 - Leave a 10 cm (minimum) space from the wall for proper ventilation.

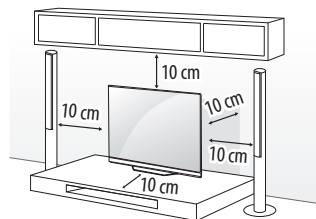

(Depending on model)

- 2 Connect the power cord to a wall outlet.



- Do not apply foreign substances (oils, lubricants, etc.) to the screw parts when assembling the product. (Doing so may damage the product.)
- If you install the TV on a stand, you need to take actions to prevent the product from overturning. Otherwise, the product may fall over, which may cause injury.
- Do not use any unapproved items to ensure the safety and product life span.
- Any damage or injuries caused by using unapproved items are not covered by the warranty.
- Make sure that the screws are inserted correctly and fastened securely. (If they are not fastened securely enough, the TV may tilt forward after being installed.) Do not use too much force and over tighten the screws; otherwise screw may be damaged and not tighten correctly.

Securing the TV to a Wall

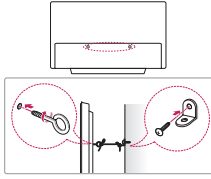

(Depending on model)

- 1 Insert and tighten the eye-bolts, or TV brackets and bolts on the back of the TV.
 - If there are bolts inserted at the eye-bolts position, remove the bolts first.
 - 2 Mount the wall brackets with the bolts to the wall. Match the location of the wall bracket and the eye-bolts on the rear of the TV.
 - 3 Connect the eye-bolts and wall brackets tightly with a sturdy rope. Make sure to keep the rope horizontal with the flat surface.
- Use a platform or cabinet that is strong and large enough to support the TV securely.
 - Brackets, bolts and ropes are not provided. You can obtain additional accessories from your local dealer.

Mounting to the Wall

Attach an optional wall mount bracket at the rear of the TV carefully and install the wall mount bracket on a solid wall perpendicular to the floor. When you attach the TV to other building materials, please contact qualified personnel. LG recommends that wall mounting be performed by a qualified professional installer. We recommend the use of LG's wall mount bracket. LG's wall mount bracket is easy to move with cables connected. When you do not use LG's wall mount bracket, please use a wall mount bracket where the device is adequately secured to the wall with enough space to allow connectivity to external devices. It is advised to connect all the cables before installing fixed wall mounts.

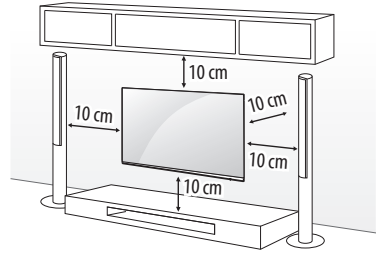



- Remove the stand before installing the TV on a wall mount by performing the stand attachment in reverse.
- For more information of screws and wall mount bracket, refer to the Separate purchase.
- If you intend to mount the product to a wall, attach VESA standard mounting interface (optional parts) to the back of the product. When you install the set to use the wall mounting bracket (optional parts), fix it carefully so as not to drop.
- When mounting a TV on the wall, make sure not to install the TV by hanging the power and signal cables on the back of the TV.
- Do not install this product on a wall if it could be exposed to oil or oil mist. This may damage the product and cause it to fall.

Connections

Connect various external devices to the TV and switch input modes to select an external device. For more information of external device's connection, refer to the manual provided with each device.

Antenna/Cable

Connect the TV to a wall antenna socket with an RF cable (75 Ω).

- Use a signal splitter to use more than 2 TVs.
- If the image quality is poor, install a signal amplifier properly to improve the image quality.
- If the image quality is poor with an antenna connected, try to realign the antenna in the correct direction.
- An antenna cable and converter are not supplied.
- For a location that is not supported with ULTRA HD broadcasting, this TV cannot receive ULTRA HD broadcasts directly.

Satellite dish

Connect the TV to a satellite dish to a satellite socket with a satellite RF cable (75 Ω). (Depending on model)

CI module



View the encrypted (pay) services in digital TV mode. (Depending on model)

- Check if the CI module is inserted into the PCMCIA card slot in the right direction. If the module is not inserted properly, this can cause damage to the TV and the PCMCIA card slot.
- If the TV does not display any video and audio when CI+ CAM is connected, please contact to the Terrestrial/Cable/Satellite Service Operator.

Other connections

Connect your TV to external devices. For the best picture and audio quality, connect the external device and the TV with the HDMI cable. Some separate cable is not provided.

HDMI

- Supported HDMI Audio format:
(Depending on model)
Dolby Digital / Dolby Digital Plus (32 kHz / 44.1 kHz / 48 kHz),
PCM (32 kHz / 44.1 kHz / 48 kHz / 96 kHz / 192 kHz)
-  →  → [Picture] → [Additional Settings] → [HDMI Ultra HD Deep Colour]
 - On: Support 4K @ 50/60 Hz (4:4:4, 4:2:2, 4:2:0)
 - Off: Support 4K @ 50/60 Hz 8 bit (4:2:0)

If the device connected to Input Port also supports ULTRA HD Deep Colour, your picture may be clearer. However, if the device doesn't support it, it may not work properly. In that case, change the TV's [HDMI Ultra HD Deep Colour] setting to Off.

USB

Some USB Hubs may not work. If a USB device connected through a USB Hub is not detected, connect it directly to the USB port on the TV.

- Use USB 1 port when connecting a webcam. USB 2 port may not support some webcam. (Depending on model)
- It is recommended that you use a USB hub or USB HDD with a power supply. (If the power supplied is not sufficient, the USB storage device may not be detected properly.)
- It is recommended that you use an external USB HDD with a rated voltage of 5 V or less and a rated current of 500 mA or less.

External Devices

Available external devices are: Blu-ray player, HD receivers, DVD players, VCRs, audio systems, USB storage devices, PC, gaming devices, and other external devices.

- The external device connection may differ from the model.
- Connect external devices to the TV regardless of the order of the TV port.
- Refer to the external equipment's manual for operating instructions.
- If you connect a gaming device to the TV, use the cable supplied with the gaming device.
- In PC mode, there may be noise associated with the resolution, vertical pattern, contrast or brightness. If noise is present, change the PC output to another resolution, change the refresh rate to another rate or adjust the brightness and contrast on the PICTURE menu until the picture is clear.
- In PC mode, some resolution settings may not work properly depending on the graphics card.
- If ULTRA HD content is played on your PC, video or audio may become disrupted intermittently depending on your PC's performance.
- When connecting via a wired LAN, it is recommended to use a CAT 7 cable. (Only when LAN port is provided.)

External Speakers

(Depending on model)

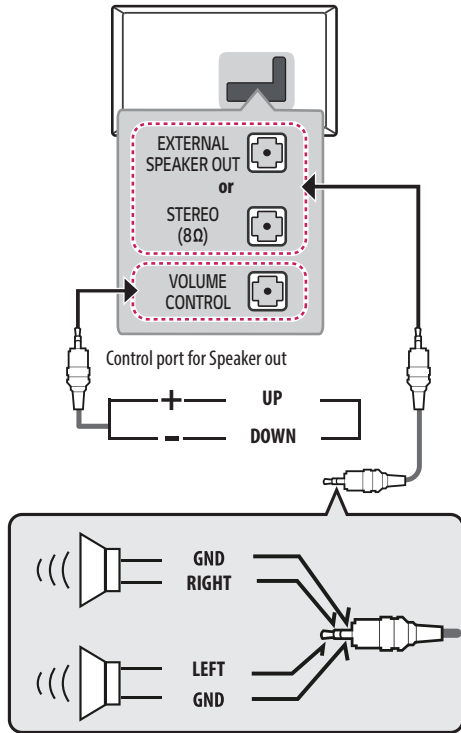

- ⚠ Use only with the 3 Pole 3.5 mm Stereo Jack.
- Do not connect your headphones or earphones to the port for connecting an external speaker.

Method of volume control port

- Cable Spec.

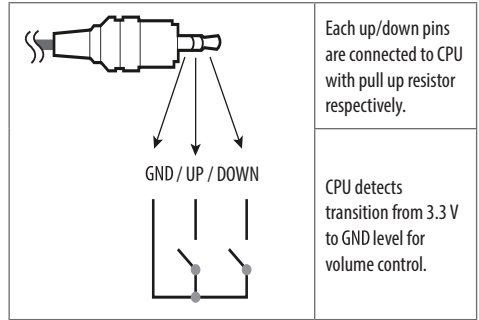

Network

Wired network connection

This TV can be connected to a Pro:Centric server via the **LAN** port. After making the physical connection, the TV needs to be set up for network communication.

Connect the **LAN** port of the Modem or Router from Pro:Centric server to the **LAN** port on the TV.

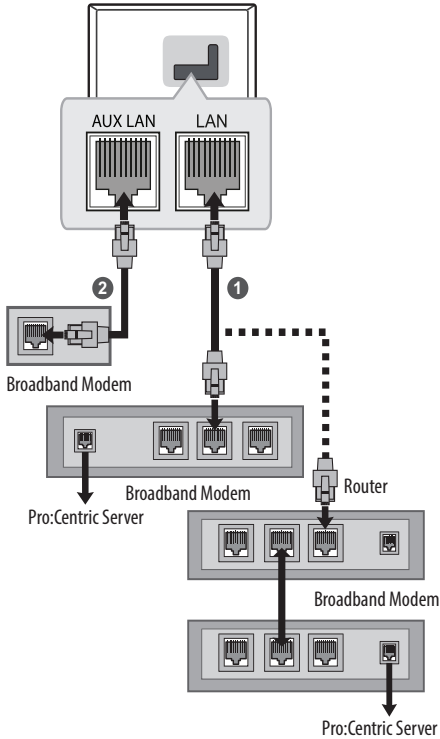

- 1 Connect the **LAN** port of the Modem or Router to the **LAN** port on the TV.
- 2 Connect the **LAN** port of the PC to the **AUX LAN** port on the TV.



- Do not connect a modular phone cable to the **LAN** port.
- Since there are various connection methods, please follow the specifications of your telecommunication carrier or internet service provider.

Using Button

You can simply operate the TV functions, using the button.

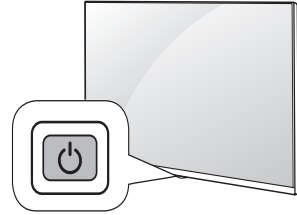

Basic functions

	Power On (Press)
	Power Off* (Press and Hold)
	Menu Control (Press ²)
	Menu Selection (Press and Hold ³)

- 1 All running apps will close.
- 2 You can access and adjust the menu by pressing the button when TV is on.
- 3 You can use the function when you access menu control.

Adjusting the menu

When the TV is turned on, press the button one time. You can adjust the Menu items using the button.

	Turns the power off.
	Changes the input source.
	Scrolls through the saved programmes.
	Adjusts the volume level.

Using Remote Control

The descriptions in this manual are based on the buttons on the remote control. Please read this manual carefully and use the TV correctly.

When the message "Magic Remote battery is low. Please change the battery." is displayed, replace the battery.

To replace batteries, open the battery cover, replace batteries (1.5 V AA) matching the \oplus and \ominus ends to the label inside the compartment, and close the battery cover. Be sure to point the magic remote toward the remote control sensor on the TV.

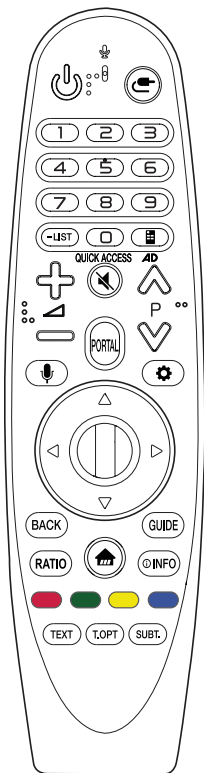

(Some buttons and services may not be provided depending on models or regions.)

* To use the button, press and hold for more than 3 seconds.

(POWER) Turns the TV on or off.

(INPUT) Changes the input source.

Number buttons Enters numbers.

LIST Accesses the saved programme list.

(Screen Remote) Displays the Screen Remote.

- Accesses the Universal Control Menu.

QUICK ACCESS* You can access apps or Live TV using the number buttons corresponding to the features.

AD* Audio descriptions function will be enabled.

Adjusts the volume level.

(MUTE) Mutes all sounds.

* (MUTE) Accesses the [Accessibility] menu.

P Scrolls through the saved programmes.

PORTAL Displays and removes hotel interactive menu.

* (Voice recognition)

Network connection is required to use the voice recognition function.

Once the voice display bar is activated on the TV screen, press and hold the button and speak your command out loud.

(Q. Settings) Accesses the Quick Settings.

* (Q. Settings) Displays the [All Settings] menu.

(Wheel (OK)) Press the centre of the Wheel button to select a menu. You can change programmes by using the wheel button.

(up/down/left/right) Press the up, down, left or right button to scroll the menu. If you press buttons while the pointer is in use, the pointer will disappear from the screen and Magic Remote will operate like a general remote control. To display the pointer on the screen again, shake Magic Remote to the left and right.

BACK Returns to the previous level.

BACK* Clears on-screen displays and returns to last input viewing.

GUIDE Shows programme guide.

RATIO Resizes an image.

(HOME) Accesses the Home menu.

* (HOME) Shows the previous history.

(INFO) Views the information of the current programme and screen.

These access special functions in some menus.

Teletext buttons (TEXT, T.OPT) These buttons are used for teletext.

SUBT. Recalls your preferred subtitle in digital mode.

Registering Magic Remote Control

How to register the Magic Remote Control

To use the Magic Remote, first pair it with your TV.

- 1 Put batteries into the Magic Remote and turn the TV on.
- 2 Point the Magic Remote at your TV and press the  **Wheel (OK)** on the remote control.

* If the TV fails to register the Magic Remote, try again after turning the TV off and back on.

How to deregister the Magic Remote Control

Press the **BACK** and  (**HOME**) buttons at the same time, for five seconds, to unpair the Magic Remote with your TV.

* Pressing and holding the **GUIDE** button will let you cancel and re-register Magic Remote at once.







- It is recommended that an Access Point (AP) be located more than 0.2 m away from the TV. If the AP is installed closer than 0.2 m, the Magic remote control may not perform as expected due to frequency interference.
- Do not mix new batteries with old batteries. This may cause the batteries to overheat and leak.
- Failure to match the correct polarities of the battery may cause the battery to burst or leak, resulting in fire, personal injury, or ambient pollution.
- This apparatus uses batteries. In your community there might be regulations that require you to dispose of these batteries properly due to environmental considerations. Please contact your local authorities for disposal or recycling information.
- The product's internal and external batteries should not be exposed to excessive heat such as direct sunlight, fire, or the like.

Troubleshooting

The software version can be updated for improvement in performance.

Customer needs to ensure the compatibility of customer's equipment with LGE software. If needed, please consult with LGE and upload revised software version according to the guidance provided by LGE.

Cannot control the TV with the remote control.

- Check the remote control sensor on the product and try again.
- Check if there is any obstacle between the product and the remote control.
- Check if the batteries are still working and properly installed ( to ,  to ).

No image display and no sound is produced.

- Check if the product is turned on.
- Check if the power cord is connected to a wall outlet.
- Check if there is a problem in the wall outlet by connecting other products.

The TV turns off suddenly.

- Check the power control settings. The power supply may be interrupted.
- Check if the auto-off function is activated on the settings related time.
- If there is no signal while the TV is on, the TV will turn off automatically after 15 minutes of inactivity.

When connecting to the PC (HDMI), no signal is detected.

- Turn the TV off/on using the remote control.
- Reconnect the HDMI cable.
- Restart the PC with the TV on.

Abnormal display

- If the product feels cold to the touch, there may be a small “flicker” when it is turned on. This is normal, there is nothing wrong with product.
- This panel is an advanced product that contains millions of pixels. You may see tiny black dots and/or brightly coloured dots (white, red, blue or green) at a size of 1 ppm on the panel. This does not indicate a malfunction and does not affect the performance and reliability of the product.
This phenomenon also occurs in third-party products and is not subject to exchange or refund.
- You may find different brightness and colour of the panel depending on your viewing position(left/right/top/down).
This phenomenon occurs due to the characteristic of the panel. It is not related with the product performance, and it is not malfunction.

Generated sound

- “Cracking” noise: A cracking noise that occurs when watching or turning off the TV is generated by plastic thermal contraction due to temperature and humidity. This noise is common for products where thermal deformation is required.
- Electrical circuit humming/panel buzzing: A low level noise is generated from a high-speed switching circuit, which supplies a large amount of current to operate a product. It varies depending on the product. This generated sound does not affect the performance and reliability of the product.



- Make sure to wring any excess water or cleaner from the cloth.
- Do not spray water or cleaner directly onto the TV screen.
- Make sure to spray just enough of water or cleaner onto a dry cloth to wipe the screen.

Specifications

(Depending on country)

Broadcasting Specifications				
	Digital TV			Analogue TV
Television system	DVB-S/S2 ¹ DVB-T/T2 ¹ DVB-C			PAL/SECAM B/G, D/K, I SECAM L
Channel coverage (Band)	DVB-S/S2 ¹	DVB-C	DVB-T/T2 ¹	46 ~ 862 MHz
	950~2,150 MHz	46 ~ 890 MHz	VHF III: 174 ~ 230 MHz UHF IV: 470 ~ 606 MHz UHF V: 606 ~ 862 MHz S Band II: 230 ~ 300 MHz S Band III: 300 ~ 470 MHz	
Maximum number of storable programmes	6,000	3,000		
External antenna impedance	75 Ω			
CI Module (W x H x D)	100.0 mm x 55.0 mm x 5.0 mm			

¹ Only DVB-T2/C/S2 support model only.

Wireless module (LGSBWAC92) specifications

Wireless LAN (IEEE 802.11a/b/g/n/ac)

Frequency Range	Output Power (Max.)
2,400 to 2,483.5 MHz	18 dBm
5,150 to 5,725 MHz	18 dBm
5,725 to 5,850 MHz	12 dBm

Bluetooth

Frequency Range	Output Power (Max.)
2,400 to 2,483.5 MHz	8 dBm

As band channels can vary per country, the user cannot change or adjust the operating frequency. This product is configured for the regional frequency table.

For consideration of the user, this device should be installed and operated with a minimum distance of 20 cm between the device and the body. "IEEE 802.11ac" is not available in all countries.

Environment condition

Operating Temperature	0 °C to 40 °C
Operating Humidity	Less than 80 %
Storage Temperature	-20 °C to 60 °C
Storage Humidity	Less than 85 %

HDMI-DTV supported mode

Resolution	Horizontal Frequency (kHz)	Vertical Frequency (Hz)
640 x 480p	31.46	59.94
	31.50	60.00
720 x 480p	31.47	59.94
	31.50	60.00
720 x 576p	31.25	50.00
1280 x 720p	44.96	59.94
	45.00	60.00
	37.50	50.00
1920 x 1080i	28.12	50.00
	33.72	59.94
	33.75	60.00
1920 x 1080p	26.97	23.97
	27.00	24.00
	33.71	29.97
	33.75	30.00
	56.25	50.00
	67.43	59.94
67.50	60.00	
1920 x 1080p	112.50	100.00
	134.86	119.88
	135.00	120.00
3840 x 2160p	53.95	23.98
	54.00	24.00
	56.25	25.00
	61.43	29.97
	67.50	30.00
	112.50	50.00
	134.86	59.94
135.00	60.00	
4096 x 2160p	53.95	23.98
	54.00	24.00
	56.25	25.00
	61.43	29.97
	67.50	30.00
	112.50	50.00
	134.86	59.94
135.00	60.00	

HDMI-PC supported Mode

- PC audio is not supported.
- Use HDMI IN 1 for PC mode. (Depending on model)

Resolution	Horizontal Frequency (kHz)	Vertical Frequency (Hz)
640 x 350	31.46	70.09
720 x 400	31.46	70.08
640 x 480	31.46	59.94
800 x 600	37.87	60.31
1024 x 768	48.36	60.00
1360 x 768	47.71	60.01
1152 x 864	54.34	60.05
1280 x 1024	63.98	60.02
1920 x 1080	67.50	60.00
	134.86	119.88
	135.00	120.00
2560 x 1440	88.78	59.95
3840 x 2160	53.95	23.98
	54.00	24.00
	56.25	25.00
	61.43	29.97
	67.50	30.00
	112.50	50.00
4096 x 2160	53.95	23.98
	54.00	24.00
	56.25	25.00
	61.43	29.97
	67.50	30.00
	112.50	50.00
134.86	59.94	
135.00	60.00	

Supported Photo Formats

File Format	Format	Resolution
.jpeg, .jpg, .jpe	JPEG	Minimum: 64 (W) x 64 (H) Maximum (Normal Type): 15360 (W) x 8640 (H) Maximum (Progressive Type): 1920 (W) x 1440 (H)
.png	PNG	Minimum: 64 (W) x 64 (H) Maximum: 5760 (W) x 5760 (H)
.bmp	BMP	Minimum: 64 (W) x 64 (H) Maximum: 1920 (W) x 1080 (H)

Supported Audio Formats

File Format	Item	Info
.mp3	Bit rate	32 kbps - 320 kbps
	Sample freq.	16 kHz - 48 kHz
	Support	MPEG1, MPEG2
	Channels	mono, stereo
.wav	Bit rate	-
	Sample freq.	8 kHz - 96 kHz
	Support	PCM
	Channels	mono, stereo
.ogg	Bit rate	64 kbps - 320 kbps
	Sample freq.	8 kHz - 48 kHz
	Support	Vorbis
	Channels	mono, stereo
.wma	Bit rate	128 kbps - 320 kbps
	Sample freq.	8 kHz - 48 kHz
	Support	WMA
	Channels	up to 6 ch
.flac	Bit rate	-
	Sample freq.	8 kHz - 96 kHz
	Support	FLAC
	Channels	mono, stereo

- The number of supported programmes may vary depending on the sample frequency.

Supported Video Formats

Extension	Codec	
.asf .wmv	Video	VC-1 Advanced Profile (except for WMVA), VC-1 Simple and Main Profiles
	Audio	WMA Standard (except for WMA v1/WMA Speech)
.avi	Video	Xvid (GMC is not supported), H.264/AVC, Motion Jpeg, MPEG-4
	Audio	MPEG-1 Layer I, II, MPEG-1 Layer III (MP3), Dolby Digital, LPCM, ADPCM
.mp4 .m4v .mov	Video	H.264/AVC, MPEG-4, HEVC, AV1
	Audio	Dolby Digital, Dolby Digital Plus, AAC, MPEG-1 Layer III (MP3), Dolby AC-4 ¹
.3gp .3g2	Video	H.264/AVC, MPEG-4
	Audio	AAC, AMR-NB, AMR-WB
.mkv	Video	MPEG-2, MPEG-4, H.264/AVC, VP8, VP9, HEVC, AV1
	Audio	Dolby Digital, Dolby Digital Plus, AAC, PCM, MPEG-1 Layer I, II, MPEG-1 Layer III (MP3)
.ts .trp .tp .mts	Video	H.264/AVC, MPEG-2, HEVC
	Audio	MPEG-1 Layer I, II, MPEG-1 Layer III (MP3), Dolby Digital, Dolby Digital Plus, AAC, PCM, Dolby AC-4 ¹
.mpg .mpeg .dat	Video	MPEG-1, MPEG-2
	Audio	MPEG-1 Layer I, II, MPEG-1 Layer III (MP3)
.vob	Video	MPEG-1, MPEG-2
	Audio	Dolby Digital, MPEG-1 Layer I, II, DVD-LPCM

1. Dolby AC-4 : This feature is available in certain models only.

Cautions for Video Playback

- ULTRA HD Video: 3840 x 2160, 4096 x 2160
- Some HEVC encoded ULTRA HD videos other than the content officially provided by LG Electronics may not be played.
- Some codecs can be supported after a software upgrade.

Extension	Codec	
.mkv .mp4 .ts	Video	H.264/AVC, HEVC
	Audio	Dolby Digital, Dolby Digital Plus, AAC

Supported External Subtitles

Subtitle	Format
External Subtitle	*.smi, *.srt, *.sub (MicroDVD, SubViewer 1.0/2.0), *.ass, *.ssa, *.txt (TMPlayer), *.psb (PowerDivX), *.dcs (DLP Cinema)
Embedded Subtitle	Matroska(mkv): Sub Station Alpha (SSA), Advanced Sub Station Alpha (ASS), SRT MP4: Timed Text

Open Source Software Notice Information

To obtain the source code under GPL, LGPL, MPL, and other open source licenses, that is contained in this product, please visit <http://opensource.lge.com>.

In addition to the source code, all referred license terms, warranty disclaimers and copyright notices are available for download.

LG Electronics will also provide open source code to you on CD-ROM for a charge covering the cost of performing such distribution (such as the cost of media, shipping, and handling) upon email request to opensource@lge.com.

This offer is valid for a period of three years after our last shipment of this product. This offer is valid to anyone in receipt of this information.

Licenses

Supported licenses may differ by model.



The terms HDMI, HDMI High-Definition Multimedia Interface, and the HDMI Logo are trademarks or registered trademarks of HDMI Licensing Administrator, Inc.

Manufactured under license from Dolby Laboratories. Dolby, Dolby Vision, Dolby Audio, Dolby Atmos, and the double-D symbol are trademarks of Dolby Laboratories.



POWERED BY



Important Information for Preventing Image Retention









OLED is a self-emissive technology, which brings many significant benefits to image quality and performance. As with any self-emitting display, it is possible for users of OLED TVs to experience temporary image retention under certain conditions, such as when displaying a static image on the screen for a long time. LG OLED TVs incorporate dedicated functions that protect the screen from possible image retention.

If a static image persists on screen, screen brightness is automatically reduced in specific areas of, or across the entire screen. Once the static image disappears, screen brightness will automatically return to its prior setting. This is not a product malfunction.



Examples of Images that may Cause Image Retention

- Still images or fixed images containing certain information that are displayed uninterrupted on the screen, such as channel numbers, station logos, programme titles, news or movie subtitles, and headlines.
- Fixed menu or icons for video game consoles or broadcasting set-top boxes.
- Black bars shown on the left, right, top, or bottom of the screen, such as in images with a 4:3 or 21:9 ratio.

Recommended Measures for Preventing Image Retention























- Avoid watching a video displaying an image as listed above for extended periods of time.
- Adjust your TV settings as below when turning on a video exhibiting an image as listed above for extended periods of time.
 -  →  → [Picture] → [Picture Mode Settings] → [Picture Mode] → [Eco]
 -  →  → [Picture] → [Picture Mode Settings] → [OLED LIGHT] → Adjust to lower value
 -  →  → [Picture] → [OLED Screen Saver] → [Logo Luminance Adjustment] → [High]
- Turn off the menu bar of an external device, such as a set-top box, to prevent long-term display of the menu bar of such device. (Please refer to the manual of the applicable external device for instructions.)
- Adjust the settings as below when watching a video constantly showing black bars on the left, right, top or bottom, in order to remove the black bars.
 -  →  → [Picture] → [Aspect Ratio Settings] → [Aspect Ratio] → [Vertical Zoom] or [4-Way Zoom]

Information on Functions Supporting Image Quality in Relation to Temporary Image Retention

- LG OLED TVs provide a feature called Pixel Refresher, which helps to prevent temporary image retention.
- When the accumulated television viewing time reaches 2,000 hours or more (this is equivalent to watching TV for five hours a day over the course of a year), Pixel Refresher will be automatically activated once your TV is turned off. When turning off your TV, a notice will appear on the screen informing the activation of Pixel Refresher. This feature will run for an hour while your TV is turned off. A horizontal line may appear at the top or bottom of the screen when the process is almost finished.
- You may also manually activate Pixel Refresher via the TV menu:
 -  →  → [Picture] → [OLED Screen Saver] → [Pixel Refresher].
- Whenever you watch your TV for more than four cumulative hours, Pixel Refresher will be automatically activated for a few minutes once your TV is turned off. (Note: Pixel Refresher will not be activated if the power cord of your TV is not plugged in or the main power is off.)

IR CODES

- This feature is not available for all models.

Code (Hexa)	Function	Note
08	 (POWER)	Remote control Button (Power On/Off)
0B	 (INPUT)	Remote control Button
11-19	Number Key 1-9	Remote control Button
4C	- LIST	Remote control Button
DE	 (Screen Remote) AD  (Voice recognition)	Remote control Button
10	Number Key 0 QUICK ACCESS	Remote control Button
02		Remote control Button
03		Remote control Button
09	 (MUTE)	Remote control Button
00	 P  Wheel (UP)	Remote control Button
01	P   Wheel (DOWN)	Remote control Button
0C	PORTAL	Remote control Button
43	 (Q. Settings)	Remote control Button
83	 Wheel (OK)	Remote control Button
40		Remote control Button
41		Remote control Button
07		Remote control Button
06		Remote control Button
28	BACK	Remote control Button
AB	GUIDE	Remote control Button
79	RATIO	Remote control Button
7C	 (HOME)	Remote control Button
AA	 INFO	Remote control Button
72	 (RED)	Remote control Button
71	 (GREEN)	Remote control Button
63	 (YELLOW)	Remote control Button
61	 (BLUE)	Remote control Button
20	TEXT	Remote control Button
21	T.OPT(T.Option)	Remote control Button
39	SUBT.	Remote control Button

EXTERNAL CONTROL DEVICE SETUP

RS-232C Setup

- Image shown may differ from your TV.
- Connect the RS-232C (serial port) input jack to an external control device (such as a computer or an A/V control system) to control the product's functions externally.

Connect the serial port of the control device to the RS-232C jack on the product back panel.

- RS-232C connection cables are not supplied with the product.

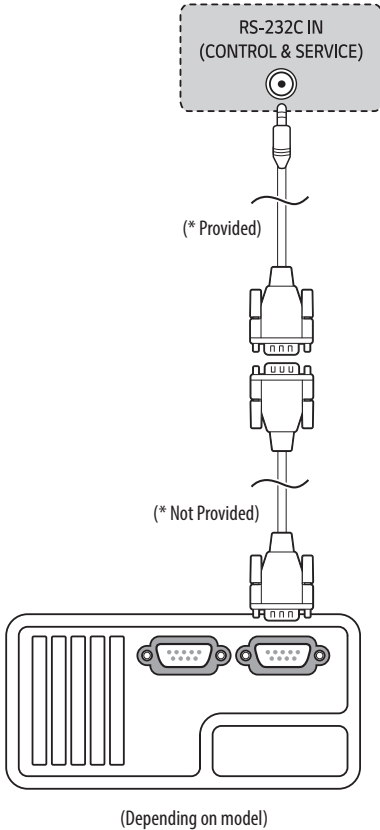

Type of Connector : D-Sub 9-Pin Male

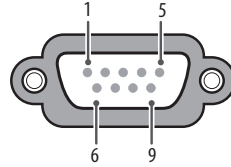

No.	Pin name
1	No Connection
2	RXD (Receive data)
3	TXD (Transmit data)
4	IR OUT from TV
5	GND
6	No Connection
7	No Connection (5 V available in some models)
8	No Connection
9	No Connection (12 V available in some models)

Command Reference List

(Depending on model)

	Command1	Command2	Data (Hexadecimal)
1 Power	k	a	00 to 01
2 [Aspect Ratio]	k	c	(See p. 25)
3 Screen Mute	k	d	(See p. 25)
4 Volume Mute	k	e	00 to 01
5 Volume Control	k	f	00 to 64
6 [Contrast]	k	g	00 to 64
7 [Brightness]	k	h	00 to 64
8 [Colour]	k	i	00 to 64
9 [Tint]	k	j	00 to 64
10 [Sharpness]	k	k	00 to 32
11 OSD Select	k	l	00 to 01
12 Remote Control Lock Mode	k	m	00 to 01
13 [Balance]	k	t	00 to 64
14 [Colour Temperature]	x	u	00 to 64
15 [Energy Saving]	j	q	(See p. 27)
16 Auto Configuration	j	u	01
17 [Equalizer]	j	v	(See p. 28)
18 Tune Command	m	a	(See p. 28)
19 Programme [Skip] / [Add]	m	b	00 to 01
20 Key	m	c	(See p. 29)
21 Control [OLED LIGHT]	m	g	00 to 64
22 Input select	x	b	(See p. 29)

- During USB operations such as DivX or EMF, all commands except Power(ka) and Key(mc) are not executed and treated as NG.

Transmission / Receiving Protocol

(Depending on Model)

Transmission

(Command1)(Command2)([Set ID])([Data])(Cr)

(Command1) : First command to control the TV. (j, k, m or x)

(Command2) : Second command to control the TV.

([Set ID]) : You can adjust the set ID to choose desired monitor ID number in option menu. Adjustment range is 1 to 99. When selecting Set ID '0', every connected set is controlled. Set ID is indicated as decimal (1 to 99) on menu and as Hexa decimal (0 x 0 to 0 x 63) on transmission/receiving protocol.

([Data]) : To transmit command data. Transmit 'FF' data to read status of command.

(Cr) : Carriage Return

ASCII code '0 x 0D'

() : ASCII code 'space (0 x 20)'

OK Acknowledgement

(Command2)([Set ID])(OK)([Data])(x)

* The set transmits ACK (acknowledgement) based on this format when receiving normal data. At this time, if the data is data read mode, it indicates present status data. If the data is data write mode, it returns the data of the PC computer.

Error Acknowledgement

(Command2)([Set ID])(NG)([Data])(x)

* The set transmits ACK (acknowledgement) based on this format when receiving abnormal data from non-viable functions or communication errors.

[Data] 00 : Illegal Code

1 Power (Command: k a)

- ▶ To control Power On/Off of the set.

Transmission

`(k)(a)()([Set ID])()([Data])(Cr)`

[Data] 00 : [Off]

[Data] 01 : [On]

Ack

`(a)()([Set ID])()(OK/NG)([Data])(x)`

- ▶ To Show TV is Power On/Off.

Transmission

`(k)(a)()([Set ID])()(FF)(Cr)`

Ack

`(a)()([Set ID])()(OK/NG)([Data])(x)`

* Similarly, if other functions transmit '0 x FF' data based on this format, Acknowledgement data feed back presents status about each function.

* OK Ack, Error Ack, and other message may display on the screen when TV is power On.

2 [Aspect Ratio] (Command: k c) (Main Picture Size)

- ▶ To adjust the screen format. (Main picture format) You can also adjust the screen format using the picture settings.

Transmission

`(k)(c)()([Set ID])()([Data])(Cr)`

[Data] 01 : [4:3] (Normal screen - [Just Scan] Off)

[Data] 02 : [16:9] (Wide screen - [Just Scan] Off)

[Data] 06 : [Original] ([Just Scan] Off)

[Data] 09 : [Just Scan]

* Please make sure that the model doesn't support both Vertical Zoom and All-Direction Zoom mode.

Ack

`(c)()([Set ID])()(OK/NG)([Data])(x)`

* Using the PC input, you select either 16:9 or 4:3 screen aspect ratio.

* In DTV/HDMI (1080i 50 Hz / 60 Hz, 720p 50 Hz / 60 Hz, 1080p 24 Hz / 30 Hz / 50 Hz / 60 Hz), Component (720p, 1080i, 1080p) mode, [Just Scan] is available.

* Full Wide is supported only for Digital, Analogue, AV.

3 Screen Mute (Command: k d)

- ▶ To select screen mute on/off.

Transmission

`(k)(d)()([Set ID])()([Data])(Cr)`

[Data] 00 : Screen mute off (Picture on) / Video mute off

[Data] 01 : Screen mute on (Picture off)

[Data] 10 : Video mute on

Ack

`(d)()([Set ID])()(OK/NG)([Data])(x)`

* In case of video mute on only, TV will display On Screen Display (OSD). But, in case of Screen mute on, TV will not display OSD.

4 Volume Mute (Command: k e)

- ▶ To control volume mute on/off.
You can also adjust mute using the mute button on remote control.

Transmission

`(k)(e)()([Set ID])()([Data])(Cr)`

[Data] 00 : Volume mute on (Volume off)

[Data] 01 : Volume mute off (Volume on)

Ack

`(e)()([Set ID])()(OK/NG)([Data])(x)`**5 Volume Control** (Command: k f)

- ▶ To adjust volume.
You can also adjust volume with the volume buttons on remote control.

Transmission

`(k)(f)()([Set ID])()([Data])(Cr)`

[Data] Min : 00 to Max : 64

* Refer to "Real data mapping".

Ack

`(f)()([Set ID])()(OK/NG)([Data])(x)`

6 [Contrast] (Command: k g)

- ▶ To adjust screen contrast.
You can also adjust contrast in the picture settings.

Transmission

`(k)(g)()([Set ID])()([Data])(Cr)`

[Data] Min : 00 to Max : 64

- * Refer to "Real data mapping".

Ack

`(g)()([Set ID])()(OK/NG)([Data])(x)`**7 [Brightness]** (Command: k h)

- ▶ To adjust screen brightness.
You can also adjust brightness in the picture settings.

Transmission

`(k)(h)()([Set ID])()([Data])(Cr)`

[Data] Min : 00 to Max : 64

- * Refer to "Real data mapping".

Ack

`(h)()([Set ID])()(OK/NG)([Data])(x)`**8 [Colour]** (Command: k i)

- ▶ To adjust the screen colour.
You can also adjust colour in the picture settings.

Transmission

`(k)(i)()([Set ID])()([Data])(Cr)`

[Data] Min : 00 to Max : 64

- * Refer to "Real data mapping".

Ack

`(i)()([Set ID])()(OK/NG)([Data])(x)`**9 [Tint]** (Command: k j)

- ▶ To adjust the screen tint.
You can also adjust tint in the picture settings.

Transmission

`(k)(j)()([Set ID])()([Data])(Cr)`

[Data] Red : 00 to Green : 64

- * Refer to "Real data mapping".

Ack

`(j)()([Set ID])()(OK/NG)([Data])(x)`**10 [Sharpness]** (Command: k k)

- ▶ To adjust the screen sharpness.
You can also adjust sharpness in the picture settings.

Transmission

`(k)(k)()([Set ID])()([Data])(Cr)`

[Data] Min : 00 to Max : 32

- * Refer to "Real data mapping".

Ack

`(k)()([Set ID])()(OK/NG)([Data])(x)`**11 OSD Select** (Command: k l)

- ▶ To select OSD (On Screen Display) on/off when controlling remotely.

Transmission

`(k)(l)()([Set ID])()([Data])(Cr)`

[Data] 00 : [Off]

[Data] 01 : [On]

Ack

`(l)()([Set ID])()(OK/NG)([Data])(x)`

12 Remote Control Lock Mode (Command: k m)

- ▶ To lock the front panel controls on the monitor and remote control.

Transmission

`(k)(m)()([Set ID])()([Data])(Cr)`

[Data] 00 : [Off]

[Data] 01 : [On]

Ack

`(m)()([Set ID])()(OK/NG)([Data])(x)`

- * If you are not using the remote control, use this mode. When main power is on/off, external control lock is released.
- * In the standby mode, if key lock is on, TV will not turn on by power on key of IR & Local Key.

13 [Balance] (Command: k t)

- ▶ To adjust balance.
You can also adjust balance in the audio settings.

Transmission

`(k)(t)()([Set ID])()([Data])(Cr)`

[Data] L : 00 to R : 64

- * Refer to "Real data mapping".

Ack

`(t)()([Set ID])()(OK/NG)([Data])(x)`**14 [Colour Temperature]** (Command: x u)

- ▶ To adjust Colour Temperature. You can also adjust Colour Temperature in the picture settings.

Transmission

`(x)(u)()([Set ID])()([Data])(Cr)`

[Data] Warm: 00 to Cool:64

- * Refer to "Real data mapping".

Ack

`(u)()([Set ID])()(OK/NG)([Data])(x)`**15 [Energy Saving]** (Command: j q)

- ▶ To reduce the power consumption of the TV. You can also adjust Energy Saving in picture settings.

Transmission

`(j)(q)()([Set ID])()([Data])(Cr)`

Power Saving Function					Level				Description
7	6	5	4		3	2	1	0	
0	0	0	0	Low Power	0	0	0	0	[Off]
0	0	0	0	Low Power	0	0	0	1	[Minimum]
0	0	0	0	Low Power	0	0	1	0	[Medium]
0	0	0	0	Low Power	0	0	1	1	[Maximum]
0	0	0	0	Low Power	0	1	0	1	[Screen Off]
0	0	0	0	Low Power	0	1	0	0	[Auto]

- ▶ [Auto] is available in TV that supports 'Intelligent Sensor'.

Ack

`(q)()([Set ID])()(OK/NG)([Data])(x)`**16 Auto Configuration** (Command: j u) (Only RGB support model)

- ▶ To adjust picture position and minimise image shaking automatically. It works only in RGB (PC) mode.

Transmission

`(j)(u)()([Set ID])()([Data])(Cr)`

[Data] 01 : To set

Ack

`(u)()([Set ID])()(OK/NG)([Data])(x)`

17 [Equalizer] (Command : j v)

► To adjust equalizer.

Transmission

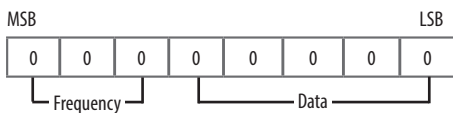
`(j)(v)()([Set ID])()([Data])(Cr)`

7	6	5	Frequency	4	3	2	1	0	Step
0	0	0	1st Band	0	0	0	0	0	0 (decimal)
0	0	1	2nd Band	0	0	0	0	1	1 (decimal)
0	1	0	3rd Band
0	1	1	4th Band	1	0	0	1	1	19 (decimal)
1	0	0	5th Band	1	0	1	0	0	20 (decimal)

Ack

`(v)()([Set ID])()(OK/NG)([Data])(x)`**18 Tune Command** (Command : m a)

► Select channel to following physical number.

Transmission

`(m)(a)()([Set ID])()([Data] 00)()([Data] 01)()([Data] 02)(Cr)`

[Data] 00 : High channel data

[Data] 01 : Low channel data

ex. No. 47 → 00 2F (2FH)

No. 394 → 01 8A (18AH),

DTV No. 0 → Don't care

[Data] 02 : (Antenna)

0 x 00 : Analogue Main

0 x 10 : DTV Main

0 x 20 : Radio

(Cable)

0 x 80 : Analogue Main

0 x 90 : DTV Main

0 x A0 : Radio

(Satellite)

0 x 40 : DTV Main

0 x 50 : Radio Main

Channel data range

Min : 00 Max : 270F (0 to 9999)

Ack

`(a)()([Set ID])()(OK/NG)([Data])(x)`

19 Programme [Skip] / [Add] (Command: m b)

- To set skip status for the current Programme.

Transmission

(m)(b)()([Set ID])()([Data])(Cr)

[Data] 00 : [Skip]

[Data] 01 : [Add]

Ack

(b)()([Set ID])()(OK/NG)([Data])(x)

20 Key (Command: m c)

- To send IR remote key code.

Transmission

(m)(c)()([Set ID])()([Data])(Cr)

[Data] IR CODES

Ack

(c)()([Set ID])()(OK/NG)([Data])(x)

21 Control [OLED LIGHT] (Command: m g)

- To control the backlight.

Transmission

(m)(g)()([Set ID])()([Data])(Cr)

[Data] Min : 00 to Max : 64

Ack

(g)()([Set ID])()(OK/NG)([Data])(x)

22 Input select (Command: x b) (Main Picture Input)

- To select input source for main picture.

Transmission

(x)(b)()([Set ID])()([Data])(Cr)

[Data] Structure

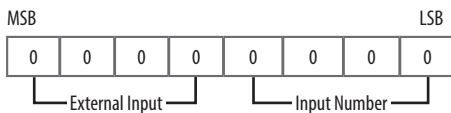

External Input				Data
0	0	0	0	DTV
0	0	0	1	Analogue
0	0	1	0	AV
0	1	0	0	Component
0	1	1	0	RGB
0	1	1	1	HDMI
1	0	0	0	
1	0	0	1	
1	0	1	0	

Input Number				Data
0	0	0	0	Input1
0	0	0	1	Input2
0	0	1	0	Input3
0	0	1	1	Input4

Ack

(b)()([Set ID])()(OK/NG)([Data])(x)

*** Real data mapping**

00:	Step 0
:	
A:	Step 10 ([Set ID] 10)
:	
F:	Step 15 ([Set ID] 15)
10:	Step 16 ([Set ID] 16)
:	
64:	Step 100
:	
6E:	Step 110
:	
73:	Step 115
74:	Step 116
:	
CF:	Step 199
:	
FE:	Step 254
FF:	Step 255



The model and serial number of the product are located on the back and on one side of the product. Record them below in case you ever need service.

Model _____

Serial No. _____