



OWNER'S MANUAL

LG Wi-Fi Sound Bar

Please read this manual carefully before operating your set and retain it for future reference. To view the instructions of advanced features, visit <http://www.lg.com> and then download Owner's Manual. Some of the content in this manual may differ from your unit.

MODEL
SK9Y (SK9Y, SPK8-W)

Safety Information



CAUTION: TO REDUCE THE RISK OF ELECTRIC SHOCK DO NOT REMOVE COVER (OR BACK) NO USER-SERVICEABLE PARTS INSIDE REFER SERVICING TO QUALIFIED SERVICE PERSONNEL



This lightning flash with arrowhead symbol within an equilateral triangle is intended to alert the user to the presence of uninsulated dangerous voltage within the product's enclosure that may be of sufficient magnitude to constitute a risk of electric shock to persons.



The exclamation point within an equilateral triangle is intended to alert the user to the presence of important operating and maintenance (servicing) instructions in the literature accompanying the product.

WARNING: TO PREVENT FIRE OR ELECTRIC SHOCK HAZARD, DO NOT EXPOSE THIS PRODUCT TO RAIN OR MOISTURE.

WARNING: Do not install this equipment in a confined space such as a book case or similar unit.

CAUTION: Do not use high voltage products around this product. (ex. Electrical swatter) This product may malfunction due to electrical shock.

CAUTION: The apparatus should not be exposed to water (dripping or splashing) and no objects filled with liquids, such as vases, should be placed on the apparatus.

CAUTION: Do not block any ventilation openings. Install in accordance with the manufacturer's instructions.

Slots and openings in the cabinet are provided for ventilation and to ensure reliable operation of the product and to protect it from over heating. The openings shall never be blocked by placing the product on a bed, sofa, rug or other similar surface. This product shall not be placed in a built-in installation such as a bookcase or rack unless proper ventilation is provided or the manufacturer's instruction has been adhered to.

CAUTION: No naked flame sources, such as lighted candles, should be placed on the apparatus.

NOTICE: For safety marking information including product identification and supply ratings, please refer to the main label on the bottom or the other surface of the product.

CAUTION concerning the Power Cord

The Power Plug is the disconnecting device. In case of an emergency, the Power Plug must remain readily accessible.

Check the specification page of this owner's manual to be certain of the current requirements.

Do not overload wall outlets. Overloaded wall outlets, loose or damaged wall outlets, extension cords, frayed power cords, or damaged or cracked wire insulation are dangerous. Any of these conditions could result in electric shock or fire. Periodically examine the cord of your device, and if its appearance indicates damage or deterioration, unplug it, discontinue use of the device, and have the cord replaced with an exact replacement part by an authorized service center. Protect the power cord from physical or mechanical abuse, such as being twisted, kinked, pinched, closed in a door, or walked upon. Pay particular attention to plugs, wall outlets, and the point where the cord exits the device.

This device is equipped with a portable battery or accumulator.

How to Safely remove the batteries or the battery pack from the equipment: To Remove the old batteries or battery pack, follow the assembly steps in reverse order. To prevent contamination of the environment and bring on possible threat to human and/or animal health, the old batteries or the battery pack must be put in an appropriate container at designated collection points. Do not dispose of batteries or battery pack together with other waste. It is recommended that you use local, free reimbursement systems batteries or battery packs, (may not be available in your area). The batteries or the battery pack should not be exposed to excessive heat such as sunshine, fire or the like.

Symbols

~	Refers to alternating current (AC).
≡	Refers to direct current (DC).
⊞	Refers to class II equipment.
⏻	Refers to stand-by.
I	Refers to "ON" (power).
⚡	Refers to dangerous voltage.

Table of Contents

1 Getting Started

- 2 Safety Information
- 6 Main Features
- 6 Introduction
- 7 Remote control
- 8 Front panel
- 9 Rear panel
- 11 Installing the sound bar
- 11 Mounting the main unit on a wall
- 13 Positioning the speakers (Optional)

2 Connecting

- 14 Organizing cables
- 14 Wireless subwoofer and rear speaker (Sold Separately) connection
 - 14 – Wireless subwoofer connection
 - 16 – Rear speakers connection (Sold Separately)
 - 17 – Surround sound
 - 20 – How to Affix the Ferrite Core
- 21 Connecting to your TV
 - 21 – Using an OPTICAL cable
 - 21 – LG Sound Sync
 - 23 – Using an HDMI cable
 - 23 – ARC (Audio Return Channel) function
 - 23 – What is SIMPLINK?
 - 24 – Additional information for HDMI
- 25 Optional equipment connection
 - 25 – DOLBY ATMOS®
 - 26 – HDMI connection
 - 26 – OPTICAL IN connection
 - 27 – PORTABLE IN connection
- 28 Network connection
 - 28 – Wired connection
 - 29 – Wireless connection
 - 29 “LG Wi-Fi Speaker”
 - 30 – Installing “LG Wi-Fi Speaker” App
 - 30 Works with the Google Assistant

3 Operating

- 31 Using a Bluetooth Wireless Technology
- 31 – About Bluetooth
- 31 – Bluetooth profiles
- 31 – Listening to Music of a Bluetooth Device
- 33 – Bluetooth connection lock (BT LOCK)
- 33 Other operations
- 33 – Using your TV remote control
- 34 – AV Sync
- 34 – Turn off the sound temporarily
- 34 – Auto display Dimmer
- 34 – Displaying input source information
- 34 – Auto power down
- 35 – AUTO POWER On/Off
- 36 – Auto function change
- 37 Sound adjustment
- 37 – Setting sound effect
- 37 – Adjust volume level automatically
- 37 – Adjust Sound level
- 38 Standby mode
- 38 – Standby mode
- 38 – Network standby mode
- 38 – Bluetooth standby mode
- 38 Reset the Speaker

4 Troubleshooting

- 39 Troubleshooting
- 39 – General
- 40 – Network
- 41 – Application
- 41 – NOTES to use wireless
- 42 – NOTES to release Demo mode

5 Appendix

- 43 File requirement
- 43 Trademarks and licenses
- 44 Specifications
- 46 Handling the Speaker
- 46 Important Information Relating to Network Services
- 47 TERMS OF USE

1

2

3

4

5

Some of the content in this manual may differ from "LG Wi-Fi Speaker" app depending on the application's version.

Main Features

LG Sound Sync

Controls volume level of this unit by the remote control of your LG TV that is compatible with LG Sound Sync.

“LG Wi-Fi Speaker” application

Listens to music stored on your smart device.

You can control this speaker with your iPod touch/ iPhone or Android device via “LG Wi-Fi Speaker” app. This speaker and your smart device must be connected to the same network. Visit Apple “App Store” or Google “Play Store” to search for “LG Wi-Fi Speaker” app. For detailed information, refer to page 29.

- Depending on the application's version and the software of smart device, “LG Wi-Fi Speaker” app may not be operated normally.
- Some smart devices may not be compatible with this speaker.

BLUETOOTH®

Listens to music stored on your **Bluetooth** device.

Surround sound

You can enjoy surround sound by using Wireless Rear Speaker kit (SPK8-S).

Introduction

Symbol used in this manual

Note

Indicates special notes and operating features.

Caution

Indicates cautions for preventing possible damages from abuse.

Remote control

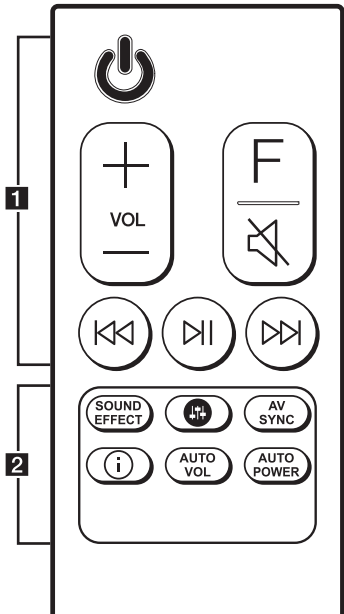

Replacement of Battery

Remove the battery cover on the rear of the remote control, and insert the battery with **+** and **-** matched correctly.

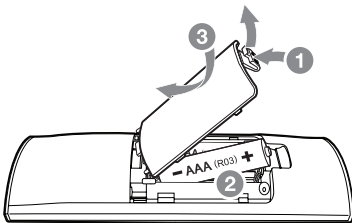

..... **1**

⏻ (Standby) : Switches the unit ON or OFF.

VOL (Volume) **+/−** : Adjusts speaker volume.

F (Function) : Selects the function and the input source.

Input source / Function	Display
Wi-Fi	WI-FI
Optical ARC LG Sound Sync (Wired)	OPT/HDMI ARC
Bluetooth	BT
LG Sound Sync (Wireless)	LG TV
HDMI IN	HDMI IN
Portable	PORTABLE

🔇 (Mute) : Mutes the sound.

⏮/⏭ (Skip) : Skips Fast backward or Forward.

⏸ (Play/Pause) : Starts playback. / Pauses playback.

..... **2**

SOUND EFFECT : Selects a sound effect mode.

🔊 : Adjusts sound level of each speaker. (Page 37)

AV SYNC :

- Synchronizes the audio and video.
- Controls TV remote. (Page 33)

i :

- Displays the input source information.
- Displays the connected **Bluetooth** device name on **Bluetooth** function.

AUTO VOL :

- Turns on or off the AUTO VOLUME mode.
- Turns on or off the surround sound. (Page 17)

AUTO POWER :

- Turns on or off AUTO POWER function. (Page 35)
- Turns on or off the **Bluetooth** connection lock. (Page 33)

Front panel

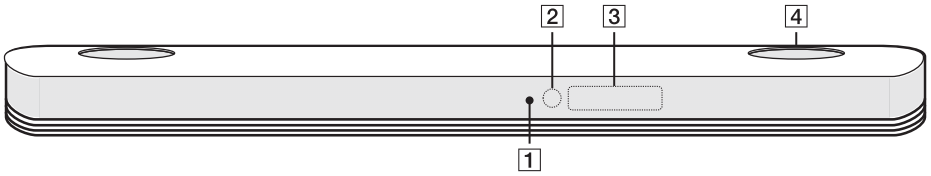

1 LED indicator

Shows connection status.

- White (Blinking): Waiting for network connection on Wi-Fi function
- White (Staying on): Network connection is completed on Wi-Fi function or the other functions are selected.
- White (Dimmed): Standby mode with network connection.
- Red (Staying on): Standby mode without network connection.

2 Remote sensor

3 Display window

4 The buttons are located on the rear.

Rear panel

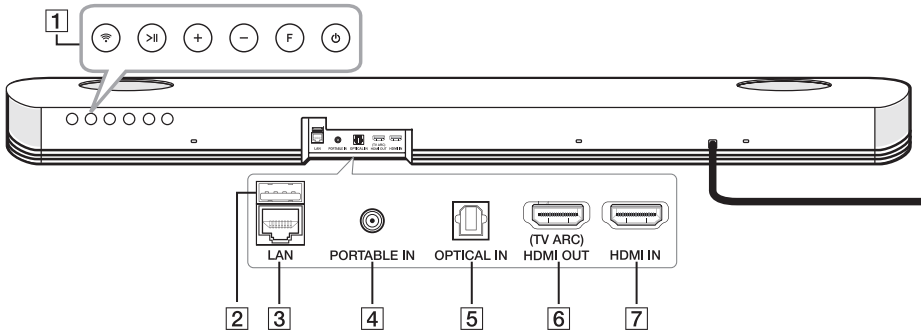

1 (Standby)

Switches the unit ON or OFF.

F (Function)

Selects the function and input source. (WI-FI, OPT/HDMI ARC, BT, LG TV, HDMI IN, PORTABLE)

—/+ (Volume)

>|| (Play/Pause)

Starts playback. / Pauses playback

(Wi-Fi)

Selects Wi-Fi function.

2 **USB (Service only)**

S/W download connector

3 **LAN port**

Connect to a router.

4 **PORTABLE IN connector**

Connect portable device.

5 **OPTICAL IN connector**

Connect to an optical device.

6 **HDMI OUT (TV ARC)**

Connect to HDMI IN (ARC) on TV.

7 **HDMI IN**

Connect to device with HDMI OUT.

Useful functions for using the unit.

Function	Description	To do	Do this
TV Remote On/Off (Page 33)	It allows you to control the volume of this unit by your TV remote control even by other company's product. Initial setting of this function was set to on.	ON	Press and hold AV SYNC on the remote control for about 3 seconds and then press the button again.
		OFF	Press and hold AV SYNC on the remote control for about 3 seconds and then press the button again.
BT Lock On/Off (Page 33)	It allows you to connect a Bluetooth device only on Bluetooth and LG TV functions. Initial setting of this function was set to off.	ON	Press and hold AUTO POWER on the remote control for about 2 seconds in Bluetooth function and then press the button again.
		OFF	Press and hold AUTO POWER on the remote control for about 2 seconds in Bluetooth function and then press the button again.
Auto Power On/Off (Page 35)	It allows the unit to turn on and off automatically by input signals : Optical, LG TV, Bluetooth or "LG Wi-Fi Speaker" app. Initial setting of this function was set to on.	ON	Press AUTO POWER on the remote control and then press the button again.
		OFF	Press AUTO POWER on the remote control and then press the button again.
BT Standby On/Off (Page 38)	It allows the unit to switch to standby mode while maintaining Bluetooth connection.	ON	Set the volume to a minimum in advance. Press and hold — on the unit and ⏻ on the remote control for about 3 seconds and then press the button again.
		OFF	Set the volume to a minimum in advance. Press and hold — on the unit and ⏻ on the remote control for about 3 seconds and then press the button again.
Network Standby On/Off (Page 38)	It allows the unit to switch to standby mode while maintaining a network connection.	ON	Press ⏻ on the unit or ⏻ on the remote control.
		OFF	Press ⏻ on the unit or ⏻ on the remote control for about 3 seconds.
Surround On/Off (Page 17)	It allows you to enjoy surround sound with rear speakers. Initial setting of this function was set to off.	ON	Press and hold AUTO VOL on the remote control for about 2 seconds and then press the button again.
		OFF	Press and hold AUTO VOL on the remote control for about 2 seconds and then press the button again.

Installing the sound bar

You can hear the sound by connecting the unit to the other device: TV, Blu-ray disc player, DVD player, etc.

Place the unit in front of the TV and connect it to the device you want. (Pages 21 - 28)

You can place the wireless subwoofer anywhere in your room. But it is better to place the subwoofer near the main unit. Turn it slightly toward the center of the room to reduce the wall reflections.



! Caution

- For best performance of wireless connection such as **Bluetooth** or wireless subwoofer, do not install the unit on Metallic furniture because wireless connection communicates through a module positioned on the bottom of the unit.
- Be careful not to make scratches on the surface of the Unit /Subwoofer when installing or moving them.

! Note

For the convenient button usage, it is recommended to take some distance between the soundbar and your TV when you install the sound bar.

Mounting the main unit on a wall

You can mount the main unit on a wall.



! Caution

Because it is difficult to make a connection after installing this unit, you should connect the cables before installation.

Preparation materials

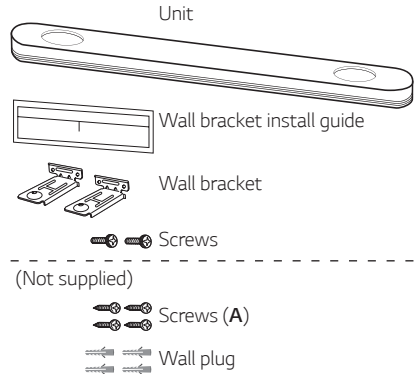

1. Match the TV's BOTTOM EDGE of Wall bracket install guide with the bottom of TV and attach to the position.

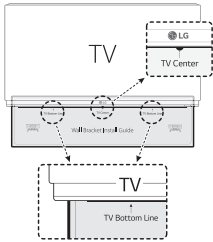

2. When you mount it on a wall (concrete), use the wall plugs. You should drill some holes. A guide sheet (Wall bracket install guide) is supplied to drill. Use the sheet to check the point to drill.

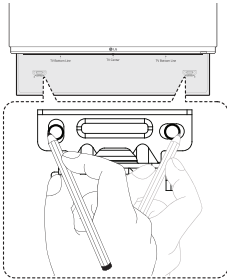

3. Remove the Wall bracket install guide.
4. Fix the brackets with screws (A) as shown in the illustration below.

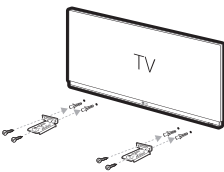

Note

Screws (A) and Wall Plugs are not supplied for mounting the unit. We recommend the Hilti (HUD-1 6 x 30) for the mounting.

5. Put the unit on the brackets to match screw holes on the bottom of the unit.

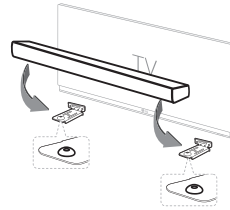

6. Fix the unit with the screws firmly.

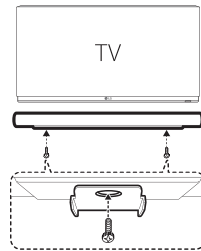

Note

To detach the unit, perform it in reverse order.

Caution

- Do not install this unit upside down. It can damage the parts of this unit or be the cause of personal injury.
- Do not hang onto the installed unit and avoid any impact to the unit.
- Secure the unit firmly to the wall so that it does not fall off. If the unit falls off, it may result in an injury or damage to the product.
- When the unit is installed on a wall, please make sure that a child does not pull any of connecting cables, as it may cause it to fall.

Positioning the speakers (Optional)

For the best surround sound, place the speakers as shown below.

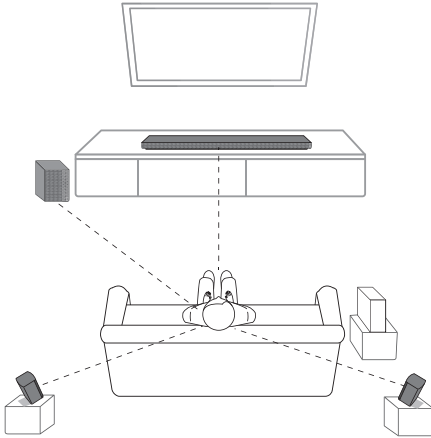

Note

The illustration above may differ from actual units.

Organizing cables

You can organize the cable with cable ties.

1. Hold the cables together with cable ties as shown below.
2. Tighten cable ties.

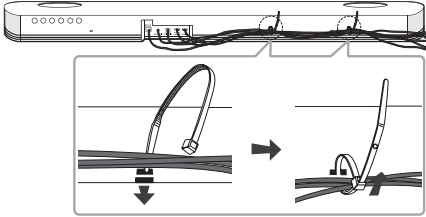

! Note

After all connections are completed, you can arrange cables as needed.

Wireless subwoofer and rear speaker (Sold Separately) connection

Wireless subwoofer connection

LED indicator of wireless subwoofer

LED Color	Status
Green (Blink)	The connection is trying.
Green	The connection is completed.
Red	The wireless subwoofer is in standby mode or the connection is failed.
Off (No display)	The power cord of wireless subwoofer is disconnected.

Setting up the wireless subwoofer for the first time

1. Connect the power cord of the sound bar and the wireless subwoofer to the outlet.
2. Turn on the sound bar. The sound bar and the wireless subwoofer will be automatically connected.

Manually pairing wireless subwoofer

When your connection is not completed, you can check red LED on the wireless subwoofer and the wireless subwoofer does not make sound. To solve the problem, follow the steps below.

1. Press **Pairing** button on the rear of the wireless subwoofer.

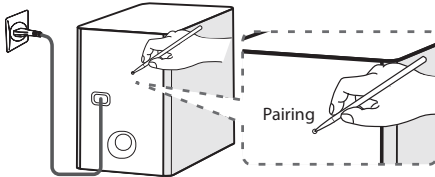

- The green LED on the rear of the wireless subwoofer blinks quickly.
(If the green LED does not blink, press and hold the **Pairing** button.)
2. Turn on the sound bar.
 3. Pairing is completed.
 - The green LED on the rear of the wireless subwoofer turns on.

! Note

- It takes a few seconds (and may take longer) for the main unit and the subwoofer to communicate with each other and make sounds.
- The closer the main unit and the subwoofer, the better sound quality. It is recommended to install the main unit and the subwoofer as close as possible and avoid the cases below.
 - There is an obstacle between the main unit and the subwoofer.
 - There is a device using same frequency with this wireless connection such as a medical equipment, a microwave or a wireless LAN device.
 - Keep the sound bar and the subwoofer away from the device (ex. wireless router, microwave oven, etc.) over 1 m to prevent wireless interference.

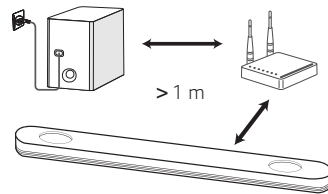

Rear speakers connection (Sold Separately)

Connecting the rear speakers

1. Connect the black stripe wire to the terminal marked - (minus) and the other end to the terminal marked + (plus).

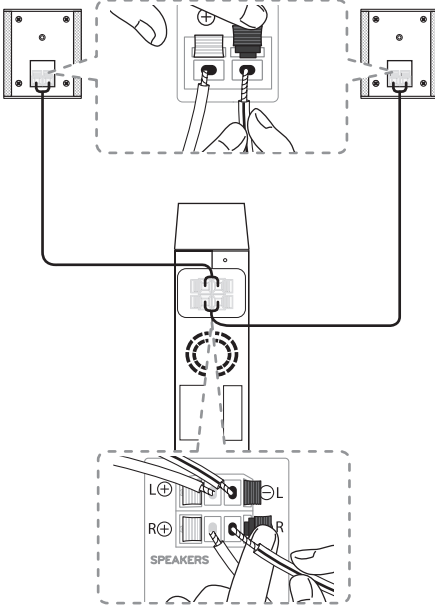

2. Connect the wireless receiver and the rear speakers (right, left) with the speaker cables.

Color	Position
Grey	Rear right
Blue	Rear left

! Note

You need to purchase the wireless rear speakers kit (SPK8-S) to enjoy surround sound.

! Caution

- Use the speaker supplied with this unit only. Using any other speaker may cause malfunction.
- Be sure to match the speaker cable to the appropriate terminal on the components: + to + and - to -. If the cables are reversed, the sound will be distorted and will lack bass.

LED indicator of wireless receiver

LED Color	Status
Yellow - green (Blink)	The connection is trying.
Yellow - green	The wireless receiver is receiving the signal from the sound bar.
Red	The wireless receiver is in standby mode.
Off (No display)	The power cord of wireless receiver is disconnected.

Setting up the wireless receiver for the first time

1. Connect the power cord to the wireless receiver to the outlet.
2. Turn on the main unit : The sound bar and wireless receiver will be automatically connected.
 - Yellow - green LED on the wireless receiver turns on.

Manually pairing wireless receiver

When your connection is not completed, you can see the red LED on the wireless receiver and rear speakers are not made sound. To solve the problem, follow the below steps.

1. Press **PAIRING** button on the rear of the wireless receiver.

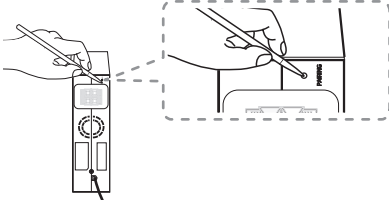

- The yellow - green LED on the wireless receiver blinks quickly.
2. Turn on the main unit
 3. Paring is completed.
 - The yellow - green LED on the wireless receiver turns on.

Surround sound

You can enjoy magnificent surround sound for all the input sound source with rear speakers.



























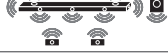

If you turn on the surround function, the whole speaker outputs sound.

When you turn off the surround function, the speakers output sound as an original input sound channel.































To turn on surround function, press and hold **AUTO VOL** on the remote control for about 2 seconds and press it once again while "OFF - SURROUND" is scrolled.

To turn off surround function, press and hold **AUTO VOL** on the remote control for about 2 seconds and press it once again while "ON - SURROUND" is scrolled.

Surround function ON

Sound Effect	Input	Output	
		No rear speakers	Rear speakers connected
ASC	2.0 Ch		
	5.1 Ch		
	7.1 Ch or more		
BASS BLAST or BASS BLAST +	2.0 Ch		
	5.1 Ch		
	7.1 Ch or more		
STANDARD	2.0 Ch		
	5.1 Ch		
	7.1 Ch or more		
MOVIE	2.0 Ch		
	5.1 Ch		
	7.1 Ch or more		
MUSIC	2.0 Ch		
	5.1 Ch		
	7.1 Ch or more		

Surround function OFF

Sound Effect	Input	Output	
		No rear speakers	Rear speakers connected
ASC	2.0 Ch		
	5.1 Ch		
	7.1 Ch or more		
BASS BLAST or BASS BLAST +	2.0 Ch		
	5.1 Ch		
	7.1 Ch or more		
STANDARD	2.0 Ch		
	5.1 Ch		
	7.1 Ch or more		
MOVIE	2.0 Ch		
	5.1 Ch		
	7.1 Ch or more		
MUSIC	2.0 Ch		
	5.1 Ch		
	7.1 Ch or more		

How to Affix the Ferrite Core

Ferrite core may not be provided depending on each nation's regulations.

Affix the Ferrite Core for speaker cables

You must affix a ferrite core in order to reduce or eliminate electrical interference.

1. Pull the stopper [a] of the ferrite core to open.
2. Wind the speaker cables around the ferrite core twice.
3. Close the ferrite core until it clicks.

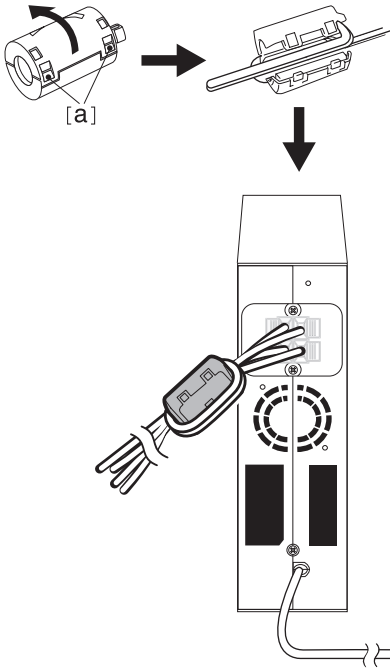

! Note

- If there is a strong electromagnetic wave product nearby, interference may occur. Put the main unit and wireless receiver away from there.
- The wireless receiver will automatically switch to standby mode in a few minutes after the sound bar is turned off. When the wireless receiver is in standby mode, the LED will turn on in red.
- When you turn on the sound bar, the wireless receiver will turn on and the LED will change to yellow - green and then the rear speakers makes sound within a few seconds.
- It takes a few seconds (and may take longer) for the main unit and Wireless Receiver to communicate with each other.
- Use the rear speaker at least 30 cm away from either TV screen or PC monitor.
- When the wireless receiver is being connected or disconnected with the main unit, output sound is maybe interrupted.
- Set the distance between the sound bar and the wireless receiver as close as possible and keep them away from the device (ex. wireless router, microwave oven, etc.) over 1 m to prevent wireless interference.

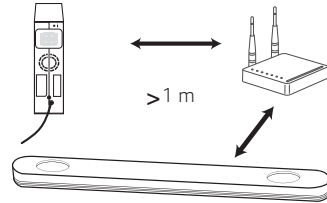

Connecting to your TV

Please connect with this unit and TV using the optical digital cable or HDMI cable considering the state of the TV.

Using an OPTICAL cable

1. Connect the OPTICAL IN jack on the back of the unit to OPTICAL OUT jack on the TV using an OPTICAL cable.

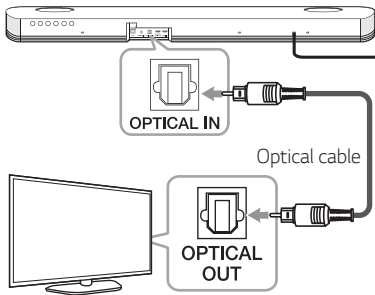

2. Select the input source to OPT/HDMI ARC by pressing F button on the remote or unit repeatedly.

You can see "OPTICAL" on the display window if connecting normally between this unit and your TV.

! Note

- Before connecting the optical cable, be sure to remove the protection plug cover if your cable has the cover.
- You can enjoy the TV audio through the speakers of this unit. In the case of some TV models, you must select the external speaker option from the TV menu. (For details, reference your TV user manual)
- Set up the sound output of TV to listen to the sound through this unit :
TV setting menu → [Sound] → [TV Sound output] → [External speaker (Optical)]
- Details of TV setting menu vary depending on the manufacturers or models of your TV.
- If this unit is connected by OPTICAL and ARC at the same time, the ARC signal is a high priority.

LG Sound Sync

Sound Sync Wireless

You can control some functions of this unit by your TV's remote control with LG Sound Sync. It is compatible with the LG TV that is supported LG Sound Sync. Make sure of the LG Sound Sync logo on your TV.

Controllable function by LG TV's remote control :
Volume up/down, mute

Refer to the TV's instruction manual for the details of LG Sound Sync.

Make one of the following connections, depending on the capabilities of your equipment.

! Note

- You can also use the remote control of this unit while using LG Sound Sync. If you use TV's remote control again, the unit synchronizes with the TV.
According to TV Specifications, the volume and mute of this unit synchronize with TV.
- When the connection fails, make sure of the condition of the TV and power.
- Make sure of the condition of this unit and the connection in the cases below when using LG Sound Sync.
 - The unit is turned off.
 - Changing the function to the others.
 - Disconnecting the optical cable.
- The amount of time to turn off this unit is different depending on your TV when you set AUTO POWER function to ON.

LG Sound Sync with wired connection

1. Connect your LG TV to the unit by using an optical cable.

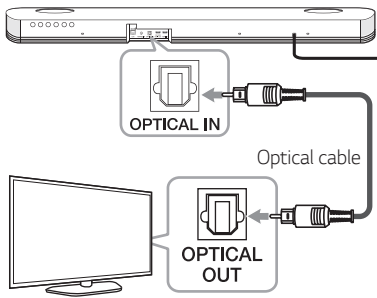

2. Set up the sound output of TV to listen to the sound through this unit :
TV setting menu → [Sound] → [TV Sound output] → [LG Sound Sync (Optical)]
3. Turn on the unit by pressing on the remote control or on the unit.
4. Select OPT/HDMI ARC function by using **F** on the remote control or **F** on the unit until the function is selected.

You can see "LG OPT" on the display window if connecting normally between this unit and your TV.

Note

Details of TV setting menu vary depending on the models of your TV.

LG Sound Sync with wireless connection

1. Turn on the unit by pressing on the remote control or on the unit.
2. Select LG TV function by using **F** on the remote control or **F** on the unit until the function is selected.
3. Set up LG Sound Sync (Wireless) on the TV. Refer to the TV's instruction manual.

"PAIRED" appears on the display window for about 3 seconds and then you can see "LG TV" on the display window if connecting normally between this unit and your TV.

Note

- If you turned off the unit directly by pressing (Power), LG Sound Sync (Wireless) will be disconnected.
- If your TV and this unit are connected through LG Sound Sync (Wireless), this unit will be Network standby mode regardless of the status of network connection when this unit is turned off. Check dimmed white LED on the unit.

Using an HDMI cable

If you connect this unit to a TV that supports HDMI CEC and ARC (Audio Return Channel), you can enjoy the TV audio through the speakers of this unit without connecting the optical cable.

1. Connect the HDMI OUT (TV ARC) jack on the back of the unit to ARC jack on the TV using an HDMI cable.

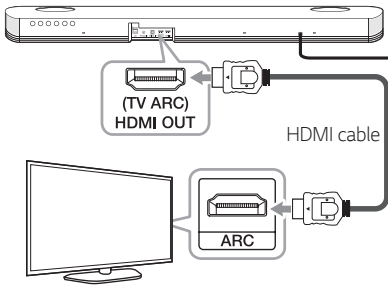

2. Select the input source to OPT/HDMI ARC by pressing F button on the remote or unit repeatedly.

You can see "ARC" on the display window if connecting normally between this unit and your TV.

! Note

- You can enjoy the TV audio through the speakers of this unit. In the case of some TV models, you must select the external speaker option from the TV menu. (For details, reference your TV user manual.)
- Set up the sound output of TV to listen to the sound through this unit :
TV setting menu → [Sound] → [TV Sound output] → [External speaker (HDMI ARC)]
- Details of TV setting menu vary depending on the manufacturers or models of your TV.
- Depending on your LG TV model, you may need to turn on the SIMPLINK function on your LG TV.
- When you return to ARC function from another function, you need to select the input source to OPT/HDMI ARC. Then this unit changes to ARC function automatically.

ARC (Audio Return Channel) function

The ARC function enables an HDMI capable TV to send the audio stream to HDMI OUT of the unit.

To use this function :

- Your TV must support the HDMI-CEC and ARC function and the HDMI-CEC and ARC must be set to On.
- The setting method of HDMI-CEC and ARC may differ depending on the TV. For details about ARC function, refer to your TV manual.
- You must use the HDMI cable (Type A, High Speed HDMI™ cable with Ethernet).
- You must connect the HDMI OUT on the unit with HDMI IN of the TV that supports ARC function using an HDMI cable.
- You can connect only one Sound bar to TV compatible with ARC.

What is SIMPLINK?



Some functions of this unit are controlled by the TV's remote control when this unit and LG TV's with SIMPLINK are connected through HDMI connection.

Controllable functions by LG TV's remote control :
Power on/off, volume up/down, etc.

Refer to the TV owner's manual for the details of SIMPLINK function.

LG TV's with SIMPLINK function has the logo as shown above.

! Note

- Depending on the state of the unit, some SIMPLINK operation may differ from your purpose or not work.
- Depending on a TV or a player which is connected with this unit, SIMPLINK operation may differ from your purpose.

Additional information for HDMI

- When you connect an HDMI or DVI compatible device make sure of the following:
 - Try switching off the HDMI/DVI device and this player. Next, switch on the HDMI/DVI device and leave it for around 30 seconds, then switch on this player.
 - The connected device's video input is set correctly for this unit.
 - The connected device is compatible with 720 x 576p (or 480p), 1280 x 720p, 1920 x 1080i, 1920 x 1080p, 4096 x 2160p or 3080 x 2160p video input.
- Not all HDCP-compatible HDMI or DVI devices will work with this player.
 - The picture will not be displayed properly with non-HDCP device.

! Note

- If a connected HDMI device does not accept the audio output of the player, the HDMI device's audio sound may be distorted or may not output.
- Changing the resolution when the connection has already been established may result in malfunctions. To solve the problem, turn off the player and then turn it on again.
- When the HDMI connection with HDCP is not verified, TV screen is changed to black screen. In this case, check the HDMI connection, or disconnect the HDMI cable.
- If there are noises or lines on the screen, please check the HDMI cable (length is generally limited to 4.5 m).
- You cannot change the video resolution in the HDMI IN mode. Change the video resolution of the connected component.
- If the video output signal is abnormal when your personal computer is connected to HDMI IN jack, change the resolution of your personal computer to 576p (or 480p), 720p, 1080i or 1080p.

HDMI cable Checklist

Some HDMI cables have poor signal transmission, which can cause problems with sound and video transmission.

Even after HDMI cable connections, if no sound, sound interrupted, noise occurring from the sound bar and/or no video, no smooth video on your TV, the HDMI cable may be the problem.

Use the cable marked with the premium HDMI certification logo. Also make sure that the your using cable is a certified Type A, Ethernet high-speed HDMI™ cable.

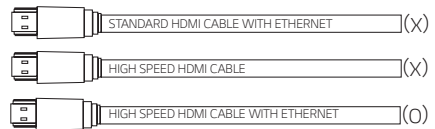

Connection through HDMI Cable*

Your television must support the newest HDMI features (HDMI CEC¹⁾ / ARC (Audio Return Channel)) to fully enjoy the Live broadcasting channel with audio system through an HDMI cable. Unless your TV supports these HDMI features, the audio system should be connected through an OPTICAL cable.

1) HDMI CEC (High-Definition Multimedia Interface Consumer Electronics Control)

Consumer Electronics Control (CEC) is an HDMI feature designed to allow the user to command and control the CEC-enabled devices, that are connected through HDMI by using only one of their remote controls.

* Trade names for CEC are SimpLink (LG), Anynet+ (Samsung), BRAVIA Sync (Sony), EasyLink (Philips), etc.

Optional equipment connection

DOLBY ATMOS®

What is DOLBY ATMOS®?

Dolby Atmos gives you amazing experience you've never before by overhead sound, and all the richness, clarity, and power of Dolby sound.

For using DOLBY ATMOS®

- DOLBY ATMOS® is available only in HDMI IN and ARC mode.
 - To use DOLBY ATMOS® in ARC mode, your TV has to support DOLBY ATMOS®.
- It is needed to set up an audio output on external devices (Blu-ray disc player, TV etc.) to "No encoding" such as "Bitstream", "Auto" or "Bypass".
 - If you can select audio output sampling rate, set it to 192 kHz.

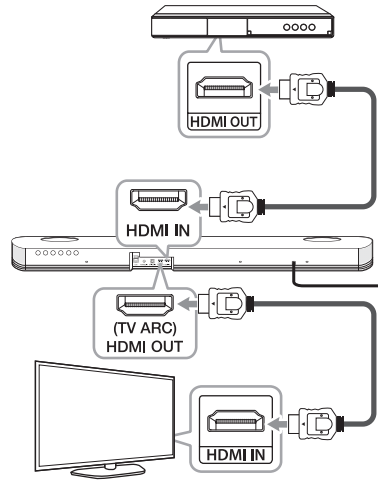

1. Connect HDMI IN jack on the back of the unit to HDMI OUT jack on the external device such as Blu-ray disc player, DVD player, etc.
2. Connect HDMI OUT (TV ARC) jack on the back of the unit to HDMI IN (ARC) jack on the TV.
3. Set the input source to HDMI IN or OPT/HDMI ARC. Press repeatedly **F** on the remote control or **F** on the unit until the function is selected.
 - If you select HDMI IN you can hear the sound from the external device. Select it when playing the external device.
 - If you select OPT/HDMI ARC, you can hear the sound from your TV. Select it when watching the TV.

You can see "DOLBY ATMOS" on the display window if connecting normally between this sound bar and your TV and DOLBY ATMOS contents is played.

! Note

- DOLBY ATMOS® supports 5.1.2 channel. (7.1.2 channel when it connected with Rear kit)
- This unit supports 4K passthrough. When you play a disc which has a 4K video signal, this unit delivers the signal to your TV.
- If the sound bar does not have sound or the video on TV is not smooth, the HDMI cable may be the problem. Refer to the HDMI cable checklist. (Page 24)

HDMI connection

You can enjoy the sound from the external device which is connected to HDMI IN jack on this unit.

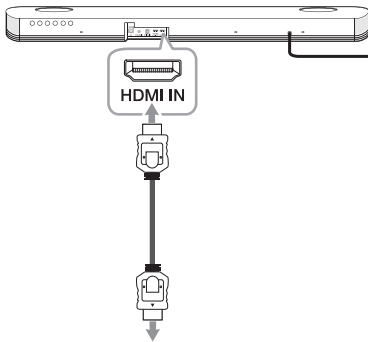

To the Blu-ray disc player,
DVD player, etc.

1. Connect HDMI IN jack on the back of the unit to HDMI OUT jack on the audio device such as Blu-ray disc player, DVD player, etc.
2. Set the input source to HDMI IN. Press repeatedly **F** on the remote control or **F** on the unit until the function is selected.

OPTICAL IN connection

Connect an optical output jack of external devices to the OPTICAL IN jack.

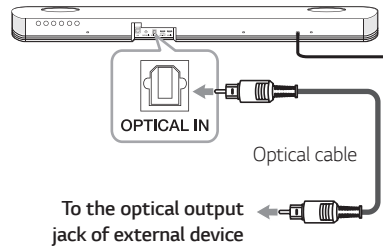

1. Connect the OPTICAL IN jack on the back of the unit to optical out jack of your external device.
2. Select the input source to OPT/HDMI ARC by pressing **F** button on the remote or unit repeatedly.

You can see "OPTICAL" on the display window if connecting normally between this unit and your device.

! Note

Before connecting the optical cable, be sure to remove the protection plug cover if your cable has the cover.

PORTABLE IN connection

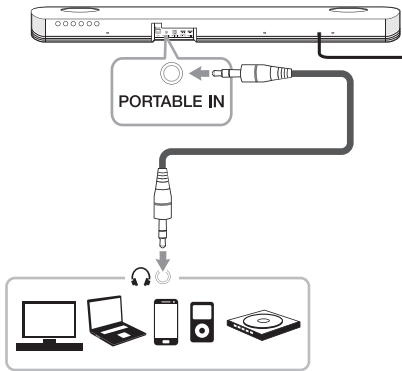

Listening to music from your portable player

The unit can be used to play the music from many types of portable players or external devices.

1. Connect the portable player to the PORTABLE IN connector of the unit.
2. Turn the power on by pressing **⏻** (Power).
3. Select the PORTABLE function by pressing **F** on the remote control or **F** on the unit until the function is selected.
4. Turn on the portable player or external device and start playing it.

Optional equipment connection

You can enjoy both sound and picture from the external device you connect.

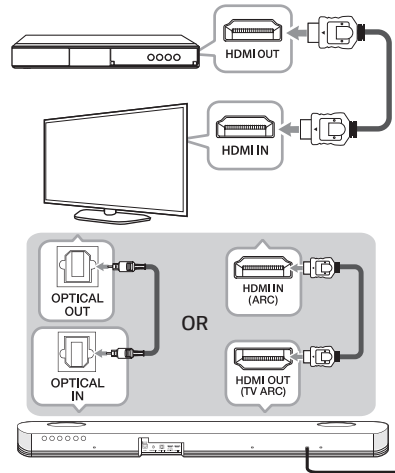

1. Connect HDMI IN jack of your TV to HDMI OUT jack on the external device such as Blu-ray disc player, DVD player, etc.
2. Connect the OPTICAL IN jack on the back of the unit to OPTICAL OUT jack on the TV using an OPTICAL cable.
Or connect the HDMI OUT (TV ARC) jack on the back of the unit to HDMI IN (ARC) jack on the TV using an HDMI cable.
3. Set the input source to OPT/HDMI ARC. Press repeatedly **F** on the remote control or **F** on the unit until the function is selected.

! Note

If the sound bar does not have sound or the video on TV is not smooth, the HDMI cable may be the problem. Refer to the HDMI cable checklist. (Page 24)

Network connection

You can enjoy various functions of this sound bar by connecting to network and your smart device with "LG Wi-Fi Speaker" app.

Choose the connection method considering your network environment.

! Note

In a network environment (Router, Internet and Internet Service Provider) that supports both IPv4 and IPv6, the network automatically connects to IPv4 or IPv6 when connecting to the network.

You can check the each network status by selecting the settings of My Speakers ([Settings]>[IP Info.]) on the "LG Wi-Fi Speaker" app.

2

Connecting

Wired connection

Using a wired connection provides the best performance, because the attached devices connect directly to the network without radio frequency interference.

Connect your sound bar to the home router using LAN cable.

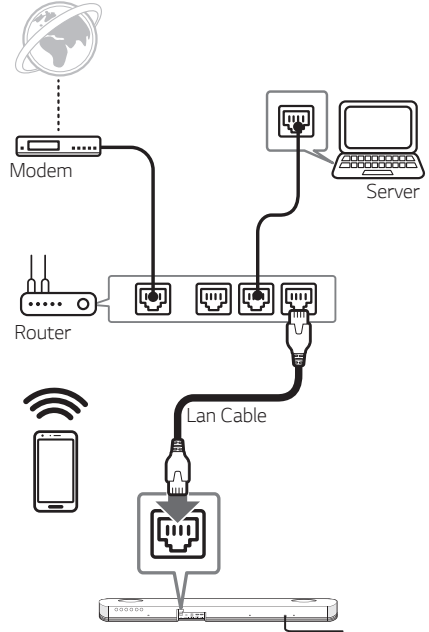

Wireless connection

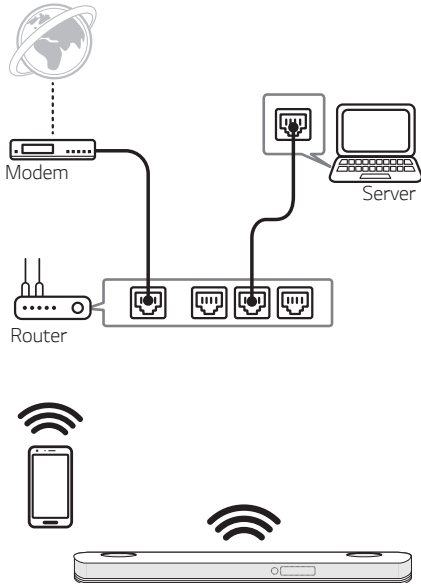

When the wired connection is unavailable between your sound bar and home router, you can connect it wirelessly.

The “LG Wi-Fi Speaker” app is required to connect the sound bar wirelessly to the network.

Download and install the “LG Wi-Fi Speaker” app on your smart device. Launch the application and follow the instructions on the screen of your smart device, so that you can connect the sound bar wirelessly.

“LG Wi-Fi Speaker”

The “LG Wi-Fi Speaker” app allows you to use various functions of this sound bar through your smart device:

Enjoying music on your device and home network server

You can listen to the music on your smart device and home network server.

Using Chromecast built-in

You can enjoy music contents through this sound bar with Chromecast enabled apps.

Setting and controlling the sound bar

You can manage the sound bar settings and control the sound bar even without remote control.

Updating the sound bar

You can update the sound bar to the latest version.

Requirements

- A **wireless router** must be connected to the internet.
- A **smart device** such as a smartphone or tablet must be connected to the wireless router via Wi-Fi connection.

! Note

For more informations of “LG Wi-Fi Speaker”, follow the instructions of the application or see the owner’s manual of “LG Wi-Fi Speaker”.

Installing “LG Wi-Fi Speaker” App

Through Apple “App Store” or Google “Play Store”

1. Tap the Apple “App Store” icon or Google “Play Store” icon.
2. Type in “LG Wi-Fi Speaker” in the search bar and tap “Search”.
3. Select “LG Wi-Fi Speaker” in the search result list to download.

Note

- “LG Wi-Fi Speaker” app will be available in version of the software as follow;
Android OS : Ver 5.0 (or later)
iOS : Ver 10 (or later)
- Depending on the device, “LG Wi-Fi Speaker” app may not work.

Works with the Google Assistant

This unit works with the Google Assistant. You can control some functions of this unit: Play and stop music and volume control.

Requirements

- Google Assistant built-in device (Sold Separately)
- This unit must be connected to Internet.
- This unit must be registered in [Google Home] app.

Using a Bluetooth Wireless Technology

About Bluetooth

Bluetooth is wireless communication technology for short range connection.

The sound may be interrupted when the connection interfered by the other electronic wave or you connect the **Bluetooth** in the other rooms.

Connecting individual devices under **Bluetooth** wireless technology does not incur any charges. A mobile phone with **Bluetooth** wireless technology can be operated via the Cascade if the connection was made via **Bluetooth** wireless technology.

- Available Devices : Smart phone, MP3, Notebook, etc.
- Version: 4.0
- Codec: SBC, AAC

Bluetooth profiles

In order to use **Bluetooth** wireless technology, devices must be able to interpret certain profiles. This speaker is compatible with following profile.

A2DP (Advanced Audio Distribution Profile)

Listening to Music of a Bluetooth Device

Before you start the pairing procedure, make sure that the **Bluetooth** feature on your smart device is turned on. Refer to your **Bluetooth** device's user guide. Once a pairing operation is performed, it does not need to be performed again.

1. Select the **Bluetooth** function by using **F** on the remote control or **F** on the unit until the function is selected.
Appears "BT" and then "BT READY" in display window.
2. Operate the **Bluetooth** device and perform the pairing operation. When searching for this speaker on your **Bluetooth** device, a list of the devices found may appear in the **Bluetooth** device display depending on the type of **Bluetooth** device.
Your speaker appears as "LG SK9Y (XX:XX)".
3. Select the "LG SK9Y (XX:XX)".

Note

- XX:XX means the last four digits of address. For example, if your unit has a MAC address such as 20:C3:8F:C9:**31:55**, you will see "LG SK9Y (31:55)" on your **Bluetooth** device.
- Depending on the **Bluetooth** device type, some device have a different pairing way. Enter the PIN code (0000) as needed.

4. When this unit is successfully connected with your **Bluetooth** device, "PAIRED" → your device's name → "BT" appears on the display window.

! Note

- If it is unavailable to display device name on the unit, "-" will be displayed.
- To check the connected device's name, press **Ⓞ** on the remote control. The connected **Bluetooth** device's name is displayed.

5. Listen to music.

To play music in your **Bluetooth** device, refer to your **Bluetooth** device's user guide.

According to your **Bluetooth** device's volume level, the volume level of **Bluetooth** will be adjusted.

! Note

- When using **Bluetooth** technology, you have to make a connection between the unit and the **Bluetooth** device as close as possible and keep the distance.
However it may not work well in the case below :
 - There is an obstacle between the unit and the **Bluetooth** device.
 - There is a device using same frequency with **Bluetooth** technology such as a medical equipment, a microwave or a wireless LAN device.

! Note

- This unit supports **Bluetooth** auto pairing. However it does not operate in the case below:
 - When you restart this unit.
 - When you disconnect this unit by yourself.
 - When you disconnect this unit on the connected **Bluetooth** device.
- The sound may be interrupted when the connection is interfered with by the some other electronic wave.
- You cannot control the **Bluetooth** device with this unit.
- Pairing is limited to "One" **Bluetooth** device. Multi-Pairing is not supported.
- Depending on the type of the device, you may not be able to use the **Bluetooth** function.
- You can enjoy using **Bluetooth** when using Phone, MP3, Notebook, etc..
- The more distance between the unit and the **Bluetooth** device, the lower the sound quality becomes.
- The **Bluetooth** connection will be disconnected when the unit is turned off or the **Bluetooth** device gets too far from the unit.
- If the **Bluetooth** connection is disconnected, connect the **Bluetooth** device again.
- When a **Bluetooth** device is not connected, "BT READY" appears on the display window.
- If you set the WI-FI function in the state of unconnected network, **Bluetooth** and Wireless TV Sound Sync may not be connected.
- If you change to another function after connecting **Bluetooth** device, **Bluetooth** connection will be disconnected. And you return to **Bluetooth** function, **Bluetooth** connection will be connected automatically.

Bluetooth connection lock (BT LOCK)

You can limit **Bluetooth** connection to only BT (**Bluetooth**) and LG TV function to prevent unintended **Bluetooth** connection.

To turn on this function, press and hold **AUTO POWER** on the remote control for about 2 seconds in BT (**Bluetooth**) function and press it once again while "OFF - BT LOCK" is scrolled. Then you can limit **Bluetooth** connection.

To turn off this function, press and hold **AUTO POWER** on the remote control for about 2 seconds in BT (**Bluetooth**) function and press it once again while "ON - BT LOCK" is scrolled.

! Note

Even if you set up BT LOCK function to On, this sound bar turns on by Auto Power function. Turn off Auto Power function to prevent it. (Page 35)

Other operations

Using your TV remote control

You can control some functions of this unit by your TV remote control even by other company's product. Controllable functions are volume up/down and mute.

Press and hold **AV SYNC** on the remote control for about 3 seconds. "ON - TV REMOTE" appears and you can control this unit by your TV remote control.

To check the status of this function, press and hold **AV SYNC**.

To turn off this function, press and hold **AV SYNC** and press it once again while "ON - TV REMOTE" is scrolled.

! Note

- Supported TV brands

LG	Panasonic	Philips	Samsung
Sharp	Sony	Toshiba	Vizio

- Make sure that the sound output of your TV is set to [External speaker].
- Depending on the remote control, this function may not work well.
- This function does not operate on LG TV's magic remote control.
- This function may not work well when some TV control functions such as HDMI CEC, SIMPLINK and LG Sound Sync set to ON.
- Some remote control may not be supported.
- Some remote control may not operate if you press repeatedly the volume button.

AV Sync

Mismatches may occur between the sound of the sound bar and the images of your TV. In the case, this function can adjust the delay time.

1. Press **AV SYNC**.
2. Use **◀◀/▶▶** to control the time which you can set at between 0 and 300 ms.

Turn off the sound temporarily

Press **Mute** to mute your unit.

You can mute your unit, for example, to answer the telephone, "MUTE" is displayed in the display window.

To cancel it, press **Mute** again on the remote control or change the volume level.

Auto display Dimmer

Display window will be darkened automatically if there is no key input for 15 seconds.

When you press any button, the display window will be brighten.

Displaying input source information

You can display various information of the input source by pressing **Info**.

OPTICAL/ARC/HDMI IN/PORTABLE : Audio format

BT (**Bluetooth**) : Connected **Bluetooth** device name

Auto power down

This unit will turn itself off to save electric consumption when the main unit is not connected to an external device and is not used for 15 minutes.

It will also turn off after six hours if the Main unit is connected to a device using portable input.

When network is connected, the speaker switches to the network standby mode. Then the LED indicator on the unit becomes dimmed in white.

If network is disconnected, the speaker switches to the standby mode. Then the LED indicator on the unit turns red.

AUTO POWER On/Off

This sound bar automatically turns on and off by an input source : Optical, LG TV, **Bluetooth** or “LG Wi-Fi Speaker” app.

This function turns on or off each time you press **AUTO POWER**.

Turning on

Turning on automatically by this function is supported only on network standby mode except an optical signal. Check dimmed white LED on the unit.

When you turn on your TV or an external device connected to this unit, this unit recognizes the input signal and selects the suitable function. You can hear the sound from your device.

If you try to connect your **Bluetooth** device, this unit turns on and the unit will be connected to your **Bluetooth** device.

When you run the “LG Wi-Fi Speaker” app and play music on your smart device that has already been paired, the sound bar is turned on to Wi-Fi function and you can listen to the music through the sound bar.

Turning off

When the TV is off, this sound bar switches to the standby mode.

! Note

- After the unit is turned on by AUTO POWER function, it will be automatically turned off if there is no signal for a certain period of time from the TV connected by LG Sound Sync (Optical/Wireless).
- After the unit is turned on by AUTO POWER function, it will be automatically turned off if there is no signal for a certain period of time from the external device.
- If you turned off the unit directly, it cannot be turned on automatically by AUTO POWER function. However the unit can be turned on by AUTO POWER function when optical signal comes in after 5 seconds of no signal.
- Depending on the connected device, this function may not operate.
- If you disconnect **Bluetooth** connection by this unit, some **Bluetooth** devices try to connect to the unit continually. Therefore it is recommended to disconnect the connection before turning off the unit.
- When you turn on this unit for the first time, status of Auto Power function is turned on.
- To use this function, the main unit must be registered in paired devices list of **Bluetooth** device.
- You can set the AUTO POWER function only when this unit is turned on.

Auto function change

This sound bar recognizes input signals such as Optical, **Bluetooth**, LG TV, Portable and “LG Wi-Fi Speaker” app and then changes suitable function automatically.

When you turns on your TV or an external device

When you turns on your TV or an external device connected by the one among Optical or LG Sound Sync (Optical or Wireless), this sound bar changes suitable function and you can listen to the sound through it.

When you try to connect a Bluetooth device

When you try to connect your **Bluetooth** device to this unit, **Bluetooth** function is selected. Play your music on the **Bluetooth** device.

When connect a Portable device

When you connect your portable device using a 3.5 mm stereo cable, this unit changes the function to Portable. You can hear the music from your device.

When you play music by “LG Wi-Fi Speaker” app

When you play music by “LG Wi-Fi Speaker” app on your smart device, this sound bar changes the function to WI-Fi and you can listen to the music through it.

! Note

- To change to optical function, it needs 5 seconds of no signal.
- This unit does not change the function to optical if SIMPLINK of the connected TV, Bluray disc player, set-top box or etc. device set to on or connected CEC supported device is turned on.
If you want to use the auto function change, turn off SIMPLINK function on your LG TV. It takes for about 30 seconds to turn off SIMPLINK.
- If the **Bluetooth** connection lock function is set, **Bluetooth** connection will be only available on **Bluetooth** and LG TV function. (Page 33)
- In WI-Fi function without network connection, you cannot connect **Bluetooth** device and LG TV through LG Sound Sync (Wireless). To make these connections, change the function to the another.

Sound adjustment

Setting sound effect

This system has a number of pre-set surround sound fields. You can select a desired sound mode by using **SOUND EFFECT**.

The displayed items for the equalizer may be different depending on sound sources and effects.

On Display	Description
ASC (Adaptive Sound Control)	Analyzes the property of the input sound and provides the sound optimized for the content in real time.
BASS BLAST or BASS BLAST+	Reinforces the bass and powerful sound.
STANDARD	You can enjoy optimized sound.
MOVIE	You can enjoy more immersive and cinematic surround sound.
MUSIC	You can enjoy more good sound for music source.

! Note

- Sound effect order may be different depending on the regional option.
- In some of the sound effect modes, there will be no sound or low sound from some of the speakers. It depends on the mode of sound and the source of audio, it is not a defect.
- You may need to reset the sound effect mode, after switching the input, sometimes even after the sound file changed.
- When a source of Dolby Atmos is inputted, sound effect will be changed to DOLBY ATMOS automatically.
In this state, even though you press the buttons, such as **SOUND EFFECT** and **AUTO VOLUME**, this unit does not respond. And you can see only "NOT SUPPORTED" on the display window.

Adjust volume level automatically

This unit supports Auto volume function that automatically adjusts the volume level.

When the output sound is too loud or too low, press **AUTO VOL** on the remote control. So you can enjoy the sound with appropriate levels.

To cancel this function, press the button again while "ON-AUTO VOLUME" is displayed.

Adjust Sound level

You can adjust the sound level of each speaker : Sub Woofer, Treble, Bass, Overhead Volume Control , Rear.

1. Press **+** button repeatedly to select the speaker you want to adjust.
2. Press **VOL +/-** to adjust the sound level.

Speaker	Display	Range
Sub Woofer	SUBWF	-15 ~ 6
Treble	TREBLE	-5 ~ 5
Bass	BASS	-5 ~ 5
Overhead Volume Control	OVC	-6 ~ 6
Rear	REAR	-6 ~ 6

! Note

Adjusting rear speakers level is applied only when the rear speakers are connected.

Standby mode



The speaker switches to the standby mode if there is no music playback or no button operation.

Standby mode

Option 1.

If network is disconnected and there is no music playback and no button operation for 15 minutes, the speaker switches to the standby mode. Then "GOOD-BYE" appears on the display window and the LED indicator on the unit turns red.

Option 2.



If you press and hold  on the unit or  on the remote control for about 3 seconds, the speaker switches to the standby mode. Then "GOOD-BYE" appears on the display window and the LED indicator on the unit turns red.

Network standby mode

Option 1.

When network is connected but music is not played and buttons are not pressed for 15 minutes, the speaker switches to the network standby mode. Then the LED indicator on the unit becomes dimmed in white.



Option 2.

If you press  on the unit or  on the remote control, the speaker switches to the network standby mode. Then the LED indicator on the unit becomes dimmed in white.

Bluetooth standby mode

If the **Bluetooth** standby mode is set to ON, the speaker switches **Bluetooth** standby mode when is turned off.

When you turn on the main unit in the **Bluetooth** standby mode, **Bluetooth** and LG TV are able to connect even if network is not connected.

Adjust volume level of the unit to minimum. And then, press and hold  on the unit and  on the remote control for about 3 seconds. You can see "ON-BT STANDBY" and the unit switches **Bluetooth** standby mode.

To cancel this function, press  while "ON-BT STANDBY" is scrolled.

Note

- If you turn off the unit in the WI-FI function, **Bluetooth** standby mode does not operate.
- To use this function, you should turn on the AUTO POWER function.

Reset the Speaker

If the speaker doesn't respond, reset the speaker.

Press and hold the  button until you hear the beep sound once. You can see "RESET" on the display window. Then all wireless network ports are deactivated and the stored wireless network information is deleted.

Troubleshooting

General

Symptoms	Cause & Solution
The unit does not work properly.	<ul style="list-style-type: none"> • Turn off the power of this unit and the connected external device (TV, Woofer, DVD-player, Amplifier, etc.) and turn them on again. • Disconnect the power cord of this unit and the connected external device (TV, Woofer, DVD-player, Amplifier, etc.) and then try connecting again. • Previous setting may not be saved when device power is shut off.
The power does not turn on.	<p>Is the power cord plugged into the outlet?</p> <ul style="list-style-type: none"> • Connect the power plug to the outlet.
Sound is not produced.	<p>Is the volume set to minimum?</p> <ul style="list-style-type: none"> • Adjust the volume. • When you are using connection with a external device (set top box, Bluetooth device etc.), adjust volume level of the device. <p>Is the mute function activated?</p> <ul style="list-style-type: none"> • Press  or adjust the volume level to cancel the mute function. <p>Is the function selected properly?</p> <ul style="list-style-type: none"> • Check the input source and select the correct input source.
No woofer sound	<p>Is the subwoofer plugged in?</p> <ul style="list-style-type: none"> • Plug the power cord of subwoofer into the wall outlet securely. <p>Is pairing between the unit and the subwoofer disconnected?</p> <ul style="list-style-type: none"> • Connect the unit and the subwoofer. (Page 14)
The remote control does not work properly.	<p>Is the remote control too far from the unit?</p> <ul style="list-style-type: none"> • Operate the remote control within about 7 m. <p>Is there an obstacle in the path of the remote control and the unit?</p> <ul style="list-style-type: none"> • Remove the obstacle. <p>Are the batteries in the remote control exhausted?</p> <ul style="list-style-type: none"> • Replace the batteries with new one.
The AUTO POWER function does not work.	<ul style="list-style-type: none"> • Check connection of the external device such as TV, DVD/Blu-Ray player or Bluetooth device. • Check the state of SIMPLINK on your LG TV and turn off SIMPLINK. • Depending on the connected device, this function may not operate.
LG Sound Sync does not work.	<ul style="list-style-type: none"> • Check whether your LG TV supports LG Sound Sync. • Check connection of LG Sound Sync. • Check sound setting of your TV and this unit.

Symptoms	Cause & Solution
When you feel the output sound of the unit is low.	<p>Check the details below and adjust the unit according to them.</p> <ul style="list-style-type: none"> • Switch the state of DRC function to [OFF] by using "LG Wi-Fi Speaker". • With the sound bar connected with TV, change the AUDIO DIGITAL OUT setting on TV Setup Menu from [PCM] to [AUTO] or [BITSTREAM]. • With the sound bar connected with Player, change the AUDIO DIGITAL OUT setting on Player Setup Menu from [PCM] to [PRIMARY PASS-THROUGH] or [BITSTREAM]. • Change Audio DRC setting on connected device setup menu to [OFF] state. • Make sure Night Mode is not On. Turn [OFF] Night Mode.
The unit does not connect with Bluetooth device.	<ul style="list-style-type: none"> • Turn off the Bluetooth connection lock function. (Page 33)

Network

Symptoms	Cause & Solution
Cannot connect the speaker to your home network.	The wireless communication may be interrupted from household devices that are using radio frequencies. Move the speaker away from them.
Media servers are not displayed on the device list.	<ul style="list-style-type: none"> • The firewall or anti-virus software on your media server is running. Turn off the firewall or anti-virus software running on your media server. • Make sure that the speaker is connected to the same network that your media server is connected.
"LG Wi-Fi Speaker" doesn't work properly.	<p>Is the "LG Wi-Fi Speaker" plugged in?</p> <ul style="list-style-type: none"> • Plug in the "LG Wi-Fi Speaker". <p>Is the LAN cable connected to the wireless router and the "LG Wi-Fi Speaker" properly?</p> <ul style="list-style-type: none"> • Connect the LAN cable to the LAN port on the back of the "LG Wi-Fi Speaker" and to your wireless router. <p>If you restart the router?</p> <ul style="list-style-type: none"> • You need to turn the speaker's power off and on again. <p>If you install new router.</p> <ul style="list-style-type: none"> • You need to perform a factory set and setup the network connection for speaker.

Application

Symptoms	Cause & Solution
“LG Wi-Fi Speaker” app doesn’t work properly.	<p>Does an error occur when accessing the app?</p> <ul style="list-style-type: none"> • Make sure that your smart device is compatible with the app. • Make sure that the “LG Wi-Fi Speaker” app is the latest version. • Make sure that the speaker’s front LED turns from red to white.

NOTES to use wireless

Symptoms	Cause & Solution
This device may have wireless interference.	<ul style="list-style-type: none"> • Wireless may not operate normally in weak signal area. • Please install the device close enough to wireless subwoofer. • Do not install the device on metal furniture for optimum performance.
Bluetooth device may malfunction or make noise in the following cases.	<ul style="list-style-type: none"> • When any part of your body contact the transceiver of the Bluetooth device or sound bar. • When there is an obstacle or wall or the device is installed in a secluded spot. • When there is a device (a wireless LAN, a medical equipment or a microwave) using same frequency, make the distance between the products as far away as possible each other. • When connecting the device to the Bluetooth device, make the distance between the products as close as possible each other. • When the device gets too far from the Bluetooth device, the connection is disconnected and also malfunction may occur.

NOTES to release Demo mode

Symptoms	Cause & Solution
Can not change input source with F button such as BT (Bluetooth), HDMI etc. and only [DEMO] indication is showing in the front display.	Unplug the power cord and plug it in again. If that doesn't work, press and hold  on the sound bar button until you hear the beep sound once. You can see "RESET" on the display window.
Remote Control does not work. (No response)	

File requirement

Available File extensions : ".mp3", ".flac", ".aac", ".ogg", ".wav"

Sampling frequency: within 32 to 48 kHz (mp3), up to 192 kHz/24 bit (flac)

Bit rate: up to 320 kbps (mp3)

- The file requirements are not always compatible. There may have some restrictions by file features and media server's ability.
- Some wav files are not supported on this speaker.
- Depending on the types of file or ways of recording, it may not play back.
- Some DRM-loaded files are not supported on this speaker.
- The types of supported files may differ depending on the operating system and/or the manufacturer of the smart device and PC.

Trademarks and licenses

All other trademarks are trademarks of their respective owners.



Manufactured under license from Dolby Laboratories. Dolby, Dolby Atmos, and the double-D symbol are Trademarks of dolby Laboratories.



For DTS patents, see <http://patents.dts.com>.
Manufactured under license from DTS Licensing Limited. DTS, the Symbol, & DTS and the Symbol together and DTS Virtual:X are registered trademarks or trademarks of DTS, Inc. in the United States and/or other countries. © DTS, Inc. All Rights Reserved.



The **Bluetooth**® word mark and logos are registered trademarks owned by the **Bluetooth** SIG, Inc. and any use of such marks by LG Electronics is under license. Other trademarks and trade names are those of their respective owners.



The terms HDMI and HDMI High-Definition Multimedia Interface, and the HDMI logo are trademarks or registered trademarks of HDMI Licensing LLC in the United States and other countries.

Specifications

General	
Power requirements	Refer to the main label on the unit.
Power consumption	Refer to the main label on the unit.
Dimensions (W x H x D)	Approx. 1 200.0 mm X 58.0 mm X 145.0 mm
Operating temperature	5 °C to 35 °C
Operating humidity	5 % to 90 %
Available Digital Input Audio Sampling Frequency	32 kHz, 44.1 kHz, 48 kHz, 88.2 kHz, 96 kHz
Available Digital Input Audio format	Dolby Atmos, Dolby Audio, DTS Digital Surround, PCM

Input/Output	
OPTICAL IN	3 V (p-p), Optical jack x 1
PORTABLE IN	0.32 Vrms (3.5 mm stereo jack) x 1
HDMI IN	19 Pin (Type A, HDMI™ connector) x 1
HDMI OUT	19 Pin (Type A, HDMI™ connector) x 1 4K Sources dependent on HDCP 2.2 are supported at 4K resolutions.

Amplifier (RMS Output)	
Total	500 W RMS
Front	43 W RMS x 2 (4 Ω at 1 kHz, THD 10 %)
Center	43 W RMS (4 Ω at 1 kHz, THD 10 %)
Surround	43 W RMS x 2 (4 Ω at 1 kHz, THD 10 %)
Top	43 W RMS x 2 (4 Ω at 1 kHz, THD 10 %)
Subwoofer	200 W RMS (3 Ω at 80 Hz, THD 10 %)

Wireless subwoofer	
Power requirements	Refer to the main label on the subwoofer.
Power consumption	Refer to the main label on the subwoofer.
Type	1 Way 1 Speaker
Impedance	3 Ω
Rated Input Power	200 W RMS
Max. Input Power	400 W RMS
Dimensions (W x H x D)	Approx. 221.0 mm x 390.0 mm x 312.8 mm

System	
LAN port	Ethernet jack x 1, 10 BASE-T/100 BASE-TX
Wireless LAN (Internal antenna)	802.11a/b/g/n Wi-Fi networks

SPK8-S (SPK8-S, S78S1-S), Sold Separately

Wireless receiver	
Power requirements	Refer to the main label on the wireless receiver.
Power consumption	Refer to the main label on the wireless receiver.
Rear	70 W RMS x 2 (3 Ω at 1 kHz, THD 10 %)
Dimensions (W x H x D)	Approx. 60.0 mm x 220.0 mm x 175.0 mm

Rear speakers (Each)	
Type	1 Way 1 Speaker
Impedance	3 Ω
Rated Input Power	70 W RMS
Max. Input Power	140 W RMS
Dimensions (W x H x D)	Approx. 100.0 mm x 140.0 mm x 100.0 mm

- Designs and specifications are subject to change without prior notice.

Handling the Speaker

When shipping the speaker

Please save the original shipping carton and packing materials. If you need to ship the speaker, for maximum protection, re-pack the speaker as it was originally packed at the factory.

Keeping the exterior surfaces clean

- Do not use volatile liquids such as insecticide spray near the speaker.
- Wiping with strong pressure may damage the surface.
- Do not leave rubber or plastic products in contact with the speaker for a long period of time.

Cleaning the speaker

To clean the player, use a soft, dry cloth. If the surfaces are extremely dirty, use a soft cloth lightly moistened with a mild detergent solution. Do not use strong solvents such as alcohol, benzine, or thinner, as these might damage the surface of the speaker.

Important Information Relating to Network Services

All information, data, documents, communications, downloads, files, text, images, photographs, graphics, videos, webcasts, publications, tools, resources, software, code, programs, applets, widgets, applications, products and other content ("Content") and all services and offerings ("Services") provided or made available by or through any third party (each a "Service Provider") is the sole responsibility of the Service Provider from whom it originated.

The availability of and access to Content and Services furnished by the Service Provider through the LGE Device are subject to change at any time, without prior notice, including, but not limited to the suspension, removal or cessation of all or any part of the Content or Services.

Should you have any inquiry or problem related to the Content or Services, you may refer to the Service Provider's website for the most up-to-date information. LGE is neither responsible nor liable for customer service related to the Content and Services. Any question or request for service relating to the Content or Services should be made directly to the respective Content and Service Providers.

Please note that LGE is not responsible for any Content or Services provided by the Service Provider or any changes to, removal of, or cessation of such Content or Services and does not warrant or guaranty the availability of or access to such Content or Services.

TERMS OF USE

These Terms of Use apply to those individuals and groups who use LG's Wi-Fi Speaker, any software(s) associated with LG Wi-Fi Speaker, this application and any services associated this application (collectively "LG Software"). They set out LGE's responsibilities to you as well as identifying the "dos" and "don'ts" that you should be aware of when you use the LG Software. LG Software is proprietary software owned by LG Electronics Inc, a corporation registered in Korea with its registered office at Yeouido-dong 20, Yeoungdeungpo-gu, Seoul, Korea. LGE, and its licensors ("LGE", "us" or "we").

By accessing or using LG Software, you confirm that you accept these Terms of Use and that you agree to comply with them. If you do not agree to these Terms of Use, you may not access or use the LG Software. To the extent that any conflict arises between these Terms of Use and any other document referred to in these Terms of Use, these Terms of Use will take precedence, unless clearly stated otherwise in the relevant document.

We grant you a non-exclusive license to use the pre-installed copy of LG Software solely to the extent necessary for you to use your LG Wi-Fi Speaker personally and for no other purpose.

You acknowledge that all ownership rights in LG Software anywhere in the world belong exclusively to us and that no ownership rights in LG Software are transferred to you. You are only entitled to the limited use of LG Software as is granted in these license terms.

You may not copy, modify, decompile or reverse engineer our software in any way unless you are allowed to do so by law. We reserve the right to suspend, withdraw or discontinue all or part of the Services without notice if we consider that you are in breach of these Terms of Use.

You acknowledge that LG Software has not been developed to meet your individual requirements. We make no promises or guarantees that LG Software is free from bugs or errors or that it will always be available. We use commercially reasonable efforts to provide LG Software on a continuous, high quality basis but cannot guarantee that they will always be available, uninterrupted or error free. It is possible that we may have to interrupt or discontinue the LG Software or suspend or restrict your use of all or any part of the Services where we consider it reasonably necessary for technical, operational, security, legal or regulatory reasons.

We do not accept any responsibility if for any reason the Services or any part of them are unavailable at any time or for any period.

Although you may use LG Software to download and access content or applications made available by third parties on your LG Software, we make no promises or guarantees that you will always be able to access such content or applications. So far as we are legally able to do so, we exclude any warranties, conditions or other terms which may be implied into these license terms by law.

So far as we are legally able to do so, we exclude any liability for any loss or damage incurred by you or any other person in connection with your use of LG Software. We are only responsible for loss or damage suffered that is a foreseeable result of our breach of these license terms or our negligence up to the amount specified below, but we are not responsible for any loss or damage that is not foreseeable. Loss or damage is foreseeable if it is an obvious consequence of our breach or if it was contemplated by you and us when you starting using LG Software.

For any loss or damage that is not excluded under these license terms, whether in contract, tort (including negligence) or otherwise, the total liability of us and our group of companies to you is limited to the amount that you paid for your LG Software service. To the extent permissible under the applicable laws, some jurisdictions do not allow the limitation or exclusion of liability for incidental or consequential damages, or have legislation that restricts the limitation or exclusion of liability, so the above limitation may not apply to you.

Nothing in these license terms shall limit or exclude our liability for death or personal injury relating from our negligence, fraud or fraudulent misrepresentation or any other liability that cannot be excluded or limited by law.

LG Software provides access to "apps" and link to other services owned and operated by third parties, such as content providers. Any third party apps, services and content that you access via the Services are made available to you by these third party providers and are outside the scope of these Terms of Use.

Your dealings with any third party providers are solely between you and the relevant provider and may be subject to the provider's own terms and conditions and privacy policy. We encourage you to read these documents, although we are not responsible for their content. We do not accept any responsibility for apps, services or content provided by third party providers.

We may impose limits on the use of or access to certain third party content, application or services, in any case without notice or liability. We expressly disclaims any responsibility or liability for any change, interruption, disabling, removal of or suspension of any content, application or service made available through this LG Software. We are neither responsible nor liable for customer service related to the content, application and services. Any question or request for service relating to third party's content, application or services should be made directly to the respective content and service providers or application developers, as appropriate.

These terms do not affect your statutory rights as a consumer.

Suitability of the Services for children and parental control tools

Modify this accordingly to suit if appropriate: The Services are not directed at children under the age of 13 and are not structured specifically to attract children under 13. Further, certain content that you may access through your use of the Services may contain material that you consider indecent, objectionable or which may not be suitable for children.

If you permit a child to use your LG Smart TV to access the Services, you are solely responsible for deciding whether or not the relevant Services are appropriate for access by that child.

[Your Smart TV offers a parental control tool (by way of a 4 digit PIN). If you have enabled the 4-digit PIN, your LG Smart TV will not be able to display restricted content unless you type in the PIN. You are responsible for setting up and maintaining the parental control tool and any other controls that are available, and we will not be responsible for any harm, loss or damage you suffer or any other user of your LG Smart TV suffers as a result of your failure to do so. Depending on the models of your LG Smart TV, these features may not be available.

Viruses and Security

Modify this accordingly to suit if appropriate: We use commercially reasonable efforts to ensure that the Services are secure and virus free, but those efforts cannot and do not guarantee that the Services will be free from bugs, viruses, or other vulnerabilities.

Further, we do not accept responsibility for any loss or damage caused by a virus, distributed denial-of-service attack, or other technologically harmful material that may infect your LG Smart TV, data or other material belonging to you, during your use of the Services.

Modify as you think appropriate: Complaints

If you have any queries, concerns or complaints about the Services, please contact [include reference to non-personal LG email address].

Modify as you think appropriate: Miscellaneous

Unless expressly stated otherwise, these Terms of Use and the documents referred to in them contain the entire agreement between us and you relating to your use of the Services and supersede any previous agreements, arrangements, undertakings or proposals, written or oral, between us and you relating to your use of the Services.

We may assign, sub-contract or otherwise transfer any or all of our rights and obligations under these Terms of Use to any company, firm or person. We can only do this if it does not materially affect your rights under these Terms of Use. You may not assign, sub-contract or otherwise transfer your rights or obligations under these Terms to anyone else (except where you dispose of your LG Smart TV to a third party) unless you first agree this with us in writing.

If we decide not to exercise or enforce any right that we have against you at a particular time, then this does not prevent us from later deciding to exercise or enforce that right.

If any part of these Terms of Use is found to be illegal, invalid or otherwise unenforceable by a court or regulator, then, where required, that part shall be deleted and the remaining parts of the Terms of Use will continue to be enforceable.

These Terms of Use do not create or infer any rights that are enforceable by any person who is not party to them.

These Terms of Use are governed by the laws of the country where your LG Smart TV is sold and both you and LGE agree to submit to the exclusive jurisdiction of the courts of the country where your LG Smart TV is sold in connection with the same

This Agreement shall be governed by the laws of the Republic of Korea, excluding their conflicts of laws provisions.

If you have any questions or comments about these Terms of Use please contact www.lg.com.

These Terms of Use may be updated by LGE from time to time. If we make a material change to our Terms of Use, we will update you via your LG Software or other means.

OPEN SOURCE SOFTWARE NOTICE INFORMATION

To obtain the source code under GPL, LGPL, MPL, and other open source licenses, that is contained in this product, please visit <http://opensource.lge.com>.

In addition to the source code, all referred license terms, warranty disclaimers and copyright notices are available for download.

LG Electronics will also provide open source code to you on CD-ROM for a charge covering the cost of performing such distribution (such as the cost of media, shipping, and handling) upon email request to opensource@lge.com.

This offer is valid for a period of three years after our last shipment of this product. This offer is valid to anyone in receipt of this information.





OWNER'S MANUAL

LG

Wi-Fi Speaker

Table of Contents

1 Getting Started

- 3 "LG Wi-Fi Speaker"
- 3 – Installing "LG Wi-Fi Speaker" App
- 4 – Starting with "LG Wi-Fi Speaker" app

2 Connecting

- 5 Connecting the Speaker to your Home Network
- 5 – Wired connection
- 6 – Simple Connection
- 7 – Manual connection

3 Operating

- 9 Enjoying the Music with "LG Wi-Fi Speaker" app
- 9 – Overview of the side menu
- 10 – Overview of [My Speakers]
- 10 – Playing a song
- 11 – Managing a song
- 12 – Overview of Playback
- 13 Settings
- 13 – Settings of the connected speaker
- 15 – Settings of "LG Wi-Fi Speaker" app

1

2

3

“LG Wi-Fi Speaker”

“LG Wi-Fi Speaker” app allows you to use various functions of this speaker through your smart device:

Enjoying music on your device and home network server

You can listen to the music on your smart device and home network server.

Using Chromecast built-in

You can enjoy music contents through this speaker with Chromecast enabled apps.

Setting and controlling the speaker

You can manage the speaker settings and control the speaker even without remote control.

Updating the speaker

You can update the speaker to the latest version.

Installing “LG Wi-Fi Speaker” App

Through Apple “App Store” or Google “Play Store”

1. Tap Apple “App Store” icon or Google “Play Store” icon.
2. Type in “LG Wi-Fi Speaker” in the search bar and tap “Search”.
3. Select “LG Wi-Fi Speaker” in the search result list to download.

! Note

- “LG Wi-Fi Speaker” app will be available in version of the software as follow;
Android OS: Ver 5.0 (or later)
iOS: Ver 10 (or later)
- Depending on the device, “LG Wi-Fi Speaker” app may not work.

Starting with “LG Wi-Fi Speaker” app

When you launch “LG Wi-Fi Speaker” app for the first time, the terms of use and Chromecast Service appear on the screen.

1. Check the contents of terms of use and select [Agree and start].



2. Check the contents of Chromecast Service and select [Agree and start].

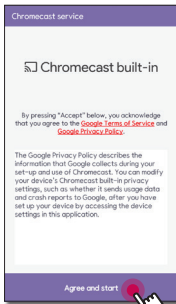

Connecting the Speaker to your Home Network

Requirements

- A **wireless router** must be connected to the internet.
- A **smart device** such as a smartphone or tablet must be connected to the wireless router via Wi-Fi connection.

Note

- Make sure that DHCP's server is activated on wireless router.
- If you cannot connect the speaker with your router, go to setting of the router and then make sure that "Allow wireless client to see each other and access my local network" box is unchecked.
- In a network environment (Router, Internet and Internet Service Provider) that supports both IPv4 and IPv6, the network automatically connects to IPv4 or IPv6 when connecting to the network.
You can check the each network status by selecting the settings of My Speakers ([Settings]> [IP Info,]) on "LG Wi-Fi Speaker" app.

Wired connection

Using a wired connection provides the best performance, because the attached devices connect directly to the network without radio frequency interference.

1. Connect your speaker to the home router using LAN cable.

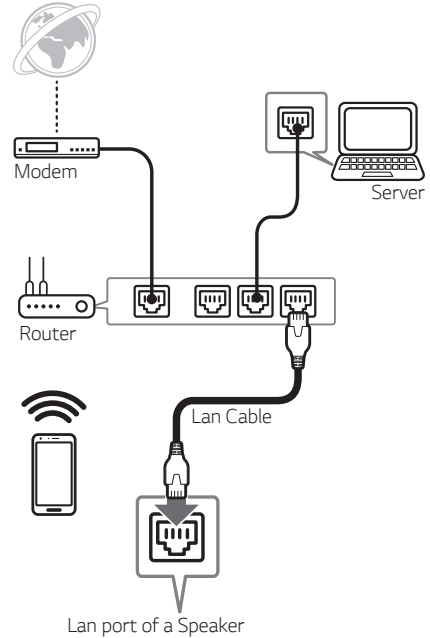

2. You can see the speaker on the screen of your smart device when you open "LG Wi-Fi Speaker" app.

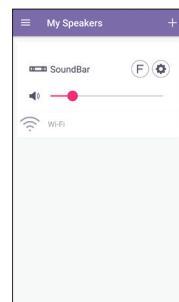

Simple Connection

Preparation

- For Simple Connection, Wi-Fi network condition is needed.
- Make sure that the **Bluetooth** setting on your smart device is on.
- Select WI-FI function by using **F** on the remote control or **F** on the speaker.

Note

Simple Connection is supported by **Bluetooth Ver 4.0** (or higher).

1. Check the position and condition of the speaker and select [Next].



If you use Android device, Location authorization is needed. Go to the next step if you use iOS device.

Allow the Location authorization. And then press [Next] again.

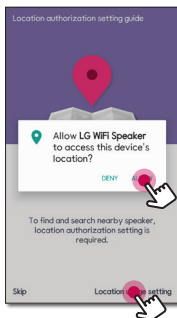

2. Then you can see the available speaker to connect.



- Select [] if the desired speaker doesn't appear.
 - Select [] to check the speaker with a beep sound.
 - Search failed, select [Retry] to search your speaker again or connect the speaker manually. (page 7)
3. Select the speaker to connect by checking [] and [Next].

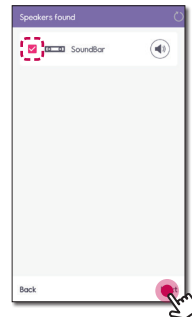

- If you have a password for your network, the security screen appears on your smart device. Enter your password and tap [Next].

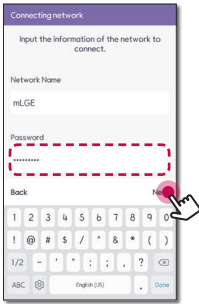

- Tap [OK] to finish making the connection.

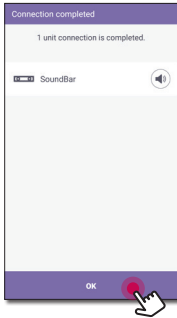

Manual connection

When the simple connection is unavailable between your speaker and smart device, you can connect it manually.

- Select [Manual setup] to connect the speaker manually.

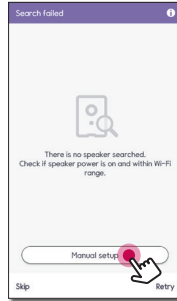

- Check the position and condition of the speaker and select [Next].



- This step is only for iOS device. Go to the next step if you use Android device.

Turn on Wi-Fi setting on your iOS device and choose [LG_Speaker_Setup_XXXX] and then go back to "LG Wi-Fi Speaker" app.

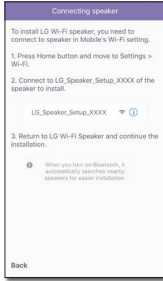

- Enter your password and tap [Next].

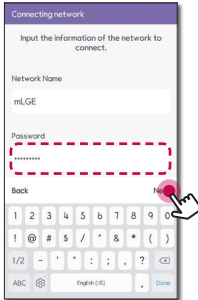

Then your smart device is searching for the available speaker to connect.

- Tap [OK] to finish making the connection.

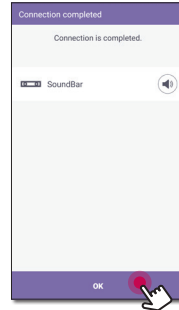

Enjoying the Music with “LG Wi-Fi Speaker” app

With “LG Wi-Fi Speaker” app, you can play music in your smart device.

Note

Some of the content in this part may differ from “LG Wi-Fi Speaker” app depending on the application’s version.

Preparation

1. Check the network connection with the speaker. (Page 5)
2. To use the speaker, you must download and install “LG Wi-Fi Speaker” app. (Page 3)

Overview of the side menu

1. Launch “LG Wi-Fi Speaker” app on your smart device. [My Speakers] appears.
2. Tap  button.

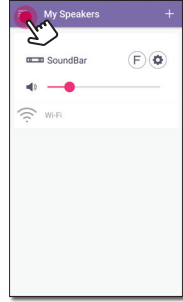

3. Side menu appears.

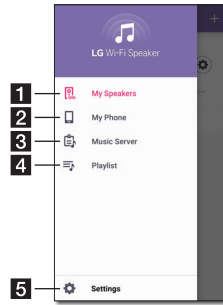

- 1** [My Speakers] – Displays the connected speaker.
- 2** [My Phone] – Displays the songs on this smart device.
- 3** [Music Server] – Displays the songs on the connected devices (Media server).
- 4** [Playlist] – Displays the playlists.
- 5** [Settings] – Displays the application settings.

Overview of [My Speakers]

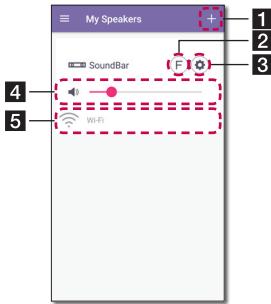

- 1** [+] – Connect additional speakers.

- 2** [Speaker Icon] – Selects a function of the connected speaker.

- 3** [Gear Icon] – Set up the connected speaker settings. (Page 13)

- 4** [Volume Icon] – Adjust volume level of the connected speaker.

- 5** [Status] – Shows state of the connected speaker.

Playing a song

1. Select [My Phone] or [Music Server] on the side menu.

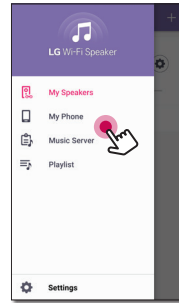

2. You can see songs on your smart device or music server. Select a song to play.
 In [My Phone] menu, the songs are sorted by [Album], [Artists], [Songs], [Genres] and [Folders] (Android device) or [iPhone Playlist] (iOS device).
 In [Music Server] menu, the connected servers appear.
3. Tap [Speaker Icon] and select the speaker. You can listen to music through the connected speaker with Chromecast.

Managing a song

On the song list of [My Phone] or [Music Server], tap [⋮] of the desired song.
The pull down menu appears.

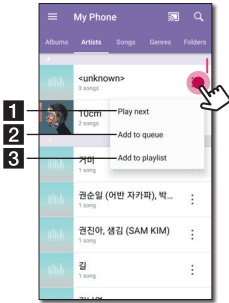

1 [Play next] – Selects music to play next.

2 [Add to queue] – Adds to queue list.

3 [Add to playlist] – Adds to a desired playlist.

! Note

Depending on your wireless environment, playing a song with the speaker may not work smoothly.

Using Playlist

You can enjoy music to suit your taste by making Playlist.

1. On the song list of [My Phone] or [Music Server], tap [⋮] of the desired song and [Add to playlist].

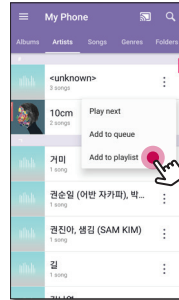

2. [Add to playlist] window appears.

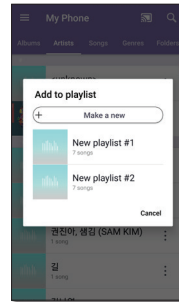

- Select a playlist to add the song.
- If you want to make another playlist, select [Make a new].

Overview of Playback

You can confirm and adjust various information on the playback screen.

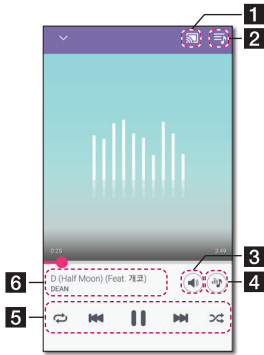

- 1 - Cast music to the connected speaker by Chromecast and stop casting the music.
- 2 - Edits the current playlist.
- 3 - Adjusts the volume of smart device or the volume of Chromecast.
- 4 - Adjusts the sound effect.

Adjusts playback.

- Pauses playback.

- Starts playback.

/ - Skips fast backward or forward.

- 5 - Repeats the desired contents. Every time you click it, the state changed in (Repeat One) - (Repeat All) - (Repeat Off) order.

- Shuffles the music on the list. Music will be played in random order.

- 6 Displays information about the currently playing song.

! Note

is disabled when you listen to music by your smart device or listen to music from speakers grouped with the [Google Home] app.

Selecting Sound effect

You can select a desired sound mode by tapping .

The displayed items for the equalizer may be different depending on the connected speaker, sound sources and effects.

1. During playback, tap .

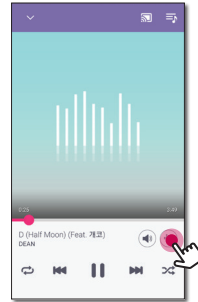

2. Select sound effect using and and tap [OK].

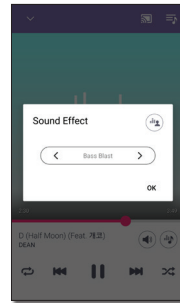

You can customize the sound effect by using to adjust Treble and Bass value.

! Note

- When you listen to music with smart device's speaker, the sound equalizer is not supported.
- Depending on the connected speaker, displayed sound effect may differ.

Settings

With “LG Wi-Fi Speaker” app, you can set the connected speaker in your smart device.

! Note

Some of the content in this part may differ from “LG Wi-Fi Speaker” app depending on the application’s version.

Preparation

1. Check the network connection with the speaker. (Page 5)
2. To use the speaker, you must download and install “LG Wi-Fi Speaker” app. (Page 3)

Settings of the connected speaker

You can set up setting of the connected speaker.

On [My Speakers] screen, select [⊕] to set up the connected speaker settings.

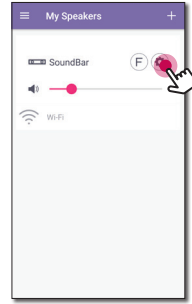

! Note

You cannot see some menu depending on the connected device.

Settings of the connected speaker appear.

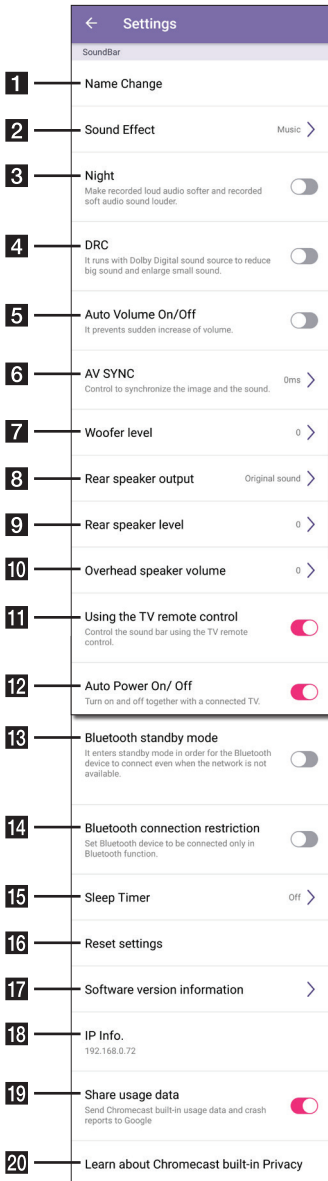

- 1 [Name Change] – Renames the speaker.
- 2 [Sound Effect] - Selects a sound effect mode.
- 3 [Night] – Turns on or off Night Mode function.
- 4 [DRC] – It reduce the volume of loud sounds or amplifies quiet sounds. (Dolby Digital only) Turns on or off DRC function.
- 5 [Auto Volume On/Off] – Turns on or off Auto Volume function.
- 6 [AV Sync] – Adjust the audio and video Synchronization.
- 7 [Woofer level] – Adjust Woofer level.
- 8 [Rear speaker output] - Select the rear speaker output.
- 9 [Rear speaker level] - Adjust Rear speaker level.
- 10 [Overhead speaker volume] - Adjust Overhead speaker volume level.
- 11 [Using the TV remote control] - Adjusts some functions of the speaker with your TV remote control.
- 12 [Auto Power On/Off] – Turns on or off Auto Power function.
- 13 [Bluetooth standby mode] – Turns on or off Bluetooth standby mode.
- 14 [Bluetooth connection restriction] – It enables you to connect Bluetooth device only on Bluetooth or LG TV function.
- 15 [Sleep timer] – Turns off by itself after the time set.
- 16 [Reset settings] – Resets the speaker settings except network information.
- 17 [Software version information] – Displays the current Software version information and updates the software to latest version.
- 18 [IP Info.] - Shows the IP address of the speaker.
- 19 [Share usage data] – Select whether to send Chromecast usage data and crash reports to Google.
- 20 [Learn about Chromecast built-in Privacy] – Shows Privacy policy of Chromecast.

Settings of “LG Wi-Fi Speaker” app

Select [Settings] on the side menu.

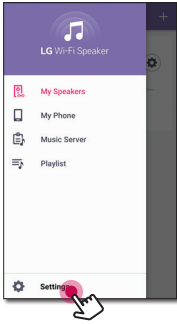

Settings of “LG Wi-Fi Speaker” app appear.

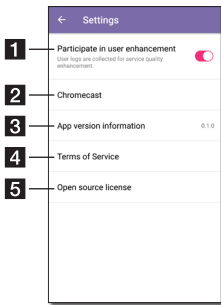

- 1** **[Participate in user enhancement]** – Allows to send user logs for service quality enhancement.
- 2** **[Chromecast]** – Displays the Chromecast menu.
- 3** **[App version information]** – Displays this application version information.
- 4** **[Terms of Service]** – Displays Terms of Service.
- 5** **[Open source license]** – Shows LGE Open Source Software Notice.

[Chromecast] Menu

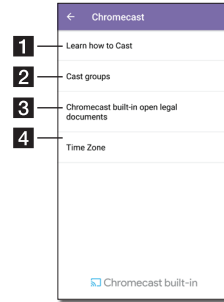

- 1** **[Learn how to cast]** - Shows how to use Chromecast.
- 2** **[Cast Groups]** - Select [Learn about Cast Groups] or [How to cast to a group] to show the selected information.
- 3** **[Chromecast built-in open legal documents]** - Select [Google Terms of Service], [Google Privacy Policy] or [Open source licenses] to show the selected information.
- 4** **[Time zone]** - Sets time zone.

! Note

To use Cast Groups, install [Google Home] application. Download the application from Apple “App Store” or Google “Play Store.”

[Time Zone] Menu

Automatic Time zone

It offers to use network provided time.

Set Time Zone

If you deselect [Automatic Time zone], you can select your time zone yourself.

