



Scan the QR code to see the manual.



OWNER'S MANUAL

DEHUMIDIFIER



Before beginning installation, read these instructions carefully. This will simplify installation and ensure that the product is installed correctly and safely. Leave these instructions near the product after installation for future reference.

ENGLISH

DD**GM*E*

TABLE OF CONTENTS

This manual may contain images or content that may be different from the model you purchased.
This manual is subject to revision by the manufacturer.

SAFETY INSTRUCTIONS

READ AND SAVE THESE INSTRUCTIONS 3
WARNING INSTRUCTIONS 3
CAUTION INSTRUCTIONS 7

OPERATION

Product Overviews 10
Preparation before Operation 13
Examining Features 15
Operating the dehumidifier 17
Using the Extra Functions 19
Emptying the Bucket 21

SMART FUNCTIONS

LG ThinQ Application 25
Smart Diagnosis 26

MAINTENANCE

Maintaining the Product 28

TROUBLESHOOTING

Before Calling for Service 31

APPENDIX

Information 34

SAFETY INSTRUCTIONS

READ AND SAVE THESE INSTRUCTIONS

The following safety guidelines are intended to prevent unforeseen risks or damage from unsafe or incorrect operation of the appliance. The guidelines are separated into 'WARNING' and 'CAUTION' as described below.

Safety Messages



This symbol is displayed to indicate matters and operations that can cause risk. Read the part with this symbol carefully and follow the instructions in order to avoid risk.



WARNING

This indicates that failure to follow the instructions can cause serious injury or death.



CAUTION

This indicates that failure to follow the instructions can cause minor injury or damage to the product.

WARNING INSTRUCTIONS

WARNING

- To reduce the risk of explosion, fire, death, electric shock, injury or scalding to persons when using this product, follow basic precautions, including the following:

Technical Safety

- This appliance is not intended for use by persons (including children) with reduced physical, sensory or mental capabilities or lack of experience and knowledge, unless they have been given supervision or instruction concerning use of the appliance by a person

responsible for their safety. Children should be supervised to ensure that they do not play with the appliance.

- If the supply cord is damaged, it must be replaced by the manufacturer, its service agent or similarly qualified person in order to avoid a hazard.
- Only an authorized repair person should disassemble, repair, or modify the appliance.
- Do not touch the power plug with wet hands.
- Do not place the power cord under rugs, carpeting or mats.
- Do not install and use broken parts.

Installation

- Do not install the appliance on an uneven or inclined surface.
- Do not install the appliance in an area exposed to direct sunlight or near heat-generating equipment.
- Do not install the product in a place where combustible gas may leak or industrial oil or metallic particulates are present.
- Do not allow the appliance to push against the power cord or plug.
- Do not bend the power cable excessively or place a heavy object on top of it.
- Do not extend the length of the power cable or alter it.
- Do not use several devices on a multi-socket extension outlet.
- Do not use the product if the power outlet is damaged or loose.
- Make sure that the power cable cannot be pulled out or damaged during operation.
- When unplugging the power cord, always pull it by the plug.
- Unplug the appliance during thunder or lightning storms or when not in use for a long time.

Operation

- If the appliance is immersed in water, stop using it and contact an LG Electronics Customer Information Center.

- If there is a gas leakage (isobutane, propane, LNG, etc.), do not touch the appliance or power plug and ventilate the area immediately.
- If you detect any abnormal noise, odor or smoke, unplug the appliance immediately and contact an LG Electronics Customer Information Center.
- Do not clean the appliance with brushes, cloths or sponges which are abrasive or made of metal.
- Do not use or store fire, combustibles (ether, benzene, alcohol, drugs, propane, butane, combustible spray, insecticide, air freshener, cosmetics, etc.) or flammable materials (candles, lamps, etc.) near the product.
- Do not allow animals or pets to chew on the power cord.
- Do not move the appliance when it is in operation.
- Do not hit the appliance.
- Do not insert hands or metal objects into the air inlet or outlet.
- Do not put flammables into the appliance.
- Do not allow children to climb on or play with the appliance.
- Do not place anything on top of the appliance.
- Do not place combustion appliances directly in the path of the dehumidifier's airway.
- Do not use the product in places where it could be splashed by water.
- Do not use the product in direct sunlight or rain.

UVnano Function

NOTE

- The relevant contents apply only to models with the UVnano function.
-
- This product uses a UVnano LED. Do not disconnect or replace the UVnano LED arbitrarily. LEDs must be replaced only by LG-approved service providers, and the appliance must be disconnected from the power supply before replacing the UV-C emitter.

- Unintended use of the appliance or damage to the housing may result in the escape of dangerous UV-C radiation. UV-C radiation may, even in little doses, cause harm to the eyes and skin.
- This appliance contains a UV-C emitter.
- The UVnano LED is not a part that needs cleaning, so do not clean the UVnano LED or parts with the UV hazard label separately.
- If the UVnano LED is damaged, do not operate it.
- This appliance contains a UV emitter. Do not stare at the light source.
- Do not operate UVnano LED outside of the appliance.
- Appliances that are obviously damaged must not be operated.
- Read the maintenance instructions before opening the appliance.

Maintenance

- Dispose of the packing materials (vinyl, styrofoam, etc.) to keep them out of reach of children.
- Take care not to injure or pinch yourself when you detach and reattach parts of the appliance.
- Turn off and unplug the appliance before cleaning it or replacing the filter.
- Do not use water to clean the dehumidifier.

CAUTION INSTRUCTIONS

CAUTION

- To reduce the risk of minor injury to persons, malfunction, or damage to the product or property when using this product, follow basic precautions, including the following:

Installation

- Do not tilt the appliance to pull or push it when transporting.
- Do not install the appliance in a vehicle, RV, or marine vessel.
- Do not place the appliance near a TV or stereo equipment.
- Do not place the appliance under bright light.
- Do not place vases or water jars on the dehumidifier.
- The appliance must be installed in accordance with national wiring regulations.
- When moving or storing the product, store the power plug in the power plug storage to prevent personal injury, damage to the cord or damage to floors.
- Do not place the appliance near curtains.
- Do not use excessive force when pulling the extension hose.

Operation

- Do not use the product for removal of toxic gas such as carbon monoxide.
- Do not use the appliance for a long time in a region with unstable voltage.
- Do not place obstacles around the air inlet or outlet.
- For safe use of the appliance, children or others with reduced mental capabilities need to be closely monitored by a person who is responsible for their safety.
- Do not use the product for special purposes such as preserving plants, precision instruments, artworks, etc.

- Do not operate the appliance with wet hands.
- Do not use the appliance while it is not in an upright position.
- Do not use the appliance near objects vulnerable to heat.
- Do not use detergents, cosmetics, chemicals, air fresheners, or disinfectants in the appliance.
- Do not touch any internal parts while the unit is operating or immediately after operation.
- Do not insert any objects into the Air outlet.
- Do not use the product in places where chemicals are used.
- Do not operate the dehumidifier without a filter.
- Turn off the dehumidifier and empty the bucket before moving the dehumidifier.
- Pull out the power plug if you will not be using the product for an extended period.
- Do not use the product in a very small space such as a closet.
- Do not keep the power cord tied up when using the product.
- Do not spray foreign substances or water into the sensor hole.
- Do not allow children to mount on the product.

Maintenance

- Do not use strong detergents or solvents to clean the appliance. Use a soft cloth to clean.
- Do not clean the appliance with an alkaline detergent.
- Do not wipe the appliance surface using sulfuric acid, hydrochloric acid or organic solvents (thinner, kerosene etc.) or attach a sticker on the appliance.
- Turn off the dehumidifier and pull out the power plug before cleaning.
- Do not allow water inside the appliance.
- Do not touch the heat exchanger.

- Wear gloves when cleaning the Product and removing the filter cover, and be careful not to injure yourself on sharp parts (such as the heat exchanger).
- Do not clean the heat exchanger arbitrarily. Doing so may result in injury.

OPERATION

- The exterior or components of the product may vary depending on the model.

Product Overviews

Front

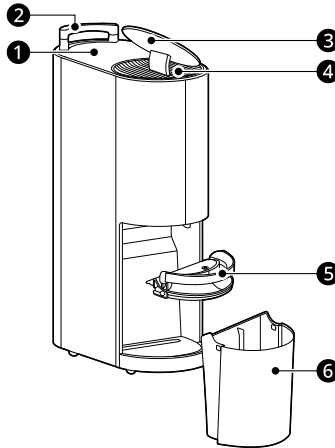

❶ Control Panel/Status Panel

- Sets the appliance functions.
- Checks the settings of the appliance.

❷ Pop-up Handle

- When you press it, a handle comes out.

❸ Louver

- Controls the direction of the wind.

❹ Air Outlet

- Emits Dehumidified air.

❺ Bucket Lid

❻ Bucket

- Stores the dehumidified water.

Back

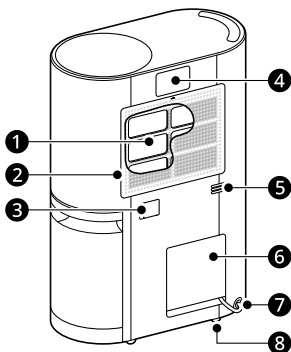

1 Pre-Filter

2 Air Inlet

- Absorbs the air and moisture in the room.

3 Drain Cap

4 Hose cover

- You can use the drying kits using the extension hose adapter.

5 Humidity Sensor

- Detects humidity in the air.

6 Power Plug Storage

7 Power plug

8 Wheels

Components

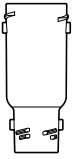

1

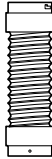

2

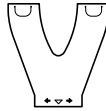

3

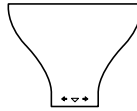

4

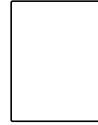

5

1 Extension Hose Adapter

- This Adapter is for connecting the extension hose to the product.

2 Extension Hose

3 Shoes Drying Kit

4 Laundry Drying Kit

5 Quick Guide

NOTE

- The extension hose adapter, extension hose and drying kits are stored in the buffer on top of the product.
Be careful not to remove them when removing the product packaging.
 - The buffer can be separated from the packaging by disassembling the top of the packaging.
-

Preparation before Operation

Checklist Before Usage

- Dehumidification amount varies depending on the indoor temperature and humidity.
 - If the temperature or humidity is low, dehumidification amount decreases.
 - Dehumidification is performed only when the desired humidity is lower than the current humidity.
- The product operates at temperature from 5 °C ~ 32 °C.
 - At 1 °C or less, dehumidified water will freeze and dehumidification function may not work properly.
 - If it is over 32 °C, the the dehumidifier may stop operation by protective device activation to prevent overheating.
- When the dehumidifier is operating, the indoor temperature will rise.
 - Dehumidifier does not have a cooling/heating function.
 - Heat is generated during the operation, so the room temperature may be increased by about 2 °C ~ 3 °C depending on the usage conditions (indoor temperature, size of the room).
 - When using the dehumidification function, the compressor operates and operation sound will be heard for about 1 ~ 2 seconds.
- The current humidity displayed on the status display may differ from the actual humidity depending on the surrounding environment and the location of the product.
- If the product is stopped and immediately restarted, it will restart after about 3 minutes to protect the product.
- If you operates the product continuously for 24 hours or more, it stops automatically to protect the product and restart after 1 hour.
- When using for the first time, water may remain in the bucket.
 - Water may remain in the bucket during the process of verifying that the product is normal. It is not a malfunction.

- Even in the same space, the humidity may varies depending on the air circulation. Additionally, the humidity may differ from the humidity measured by other products and hygrometers.

Transportation Requirements

- When moving or storing the product, store the power plug in the power plug storage to keep the power plug from touching the floor.
 - Failure to do so may damage the power plug or scratch the floor.
 - Hold the pop-up handle on the top of the product and move the product safely.
- When lifting and moving the product, be sure to remove the bucket, then move it safely by holding the pop-up handle and the protrusion on the top of the bucket.

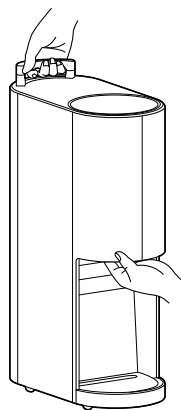

Installation Location Requirements

Install the product at least 30 cm from walls.

14 OPERATION

- If there is not enough room for air suction, the dehumidification performance may be affected.

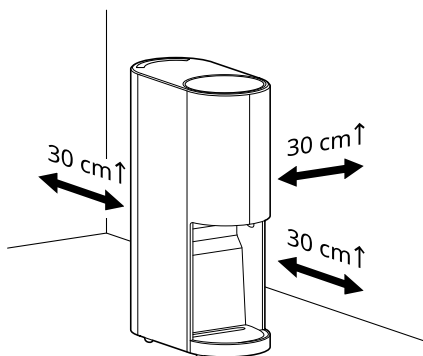

- Do not install the product near direct sunlight or bright lighting.
 - Doing so may cause discoloration of the product.

Examining Features

Controlling the Dehumidifier

Control Panel

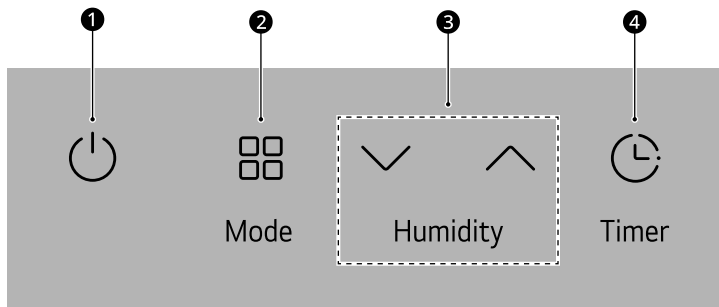

1 Start/Stop Button

Turns the product on and off.

- To prepare the product to connect to Wi-Fi through the **LG ThinQ** application, press and hold the button for 3 seconds.

2 Mode Button

Sets the operating mode.

- Each time you press the **Mode** button, the mode changes in the order of **Smart⁺ → Silent → Laundry → Spot**.
- To turn the **Auto Clean** function on and off, press the button for 3 seconds.

3 Humidity Button

Adjusts the desired humidity.

- To set the lock function, press the **▲** button for 3 seconds.
- To turn the lighting function on and off, press the **▼** button for 3 seconds.

4 Timer Button

Schedules the time to turn off the product.

NOTE

- Press the buttons on the control panel for 3 seconds to use the extra functions.

Long press (more than 3 seconds)	Extra Functions
▼ + ▲	Smart Diagnosis

Status Panel

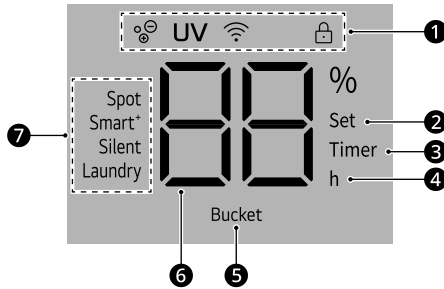

1 Icons

Icon	Description
	Lights up when the ionizer function is activated.
UV	Lights up when the UVnano function is activated.
	Lights up when the Wi-Fi function is established.
	Lights up when the control panel is locked.

2 Set Indicator

- Lights up when setting the desired humidity.

3 Timer Indicator

- Lights up when the timer is set.

4 Time Indicator

- Lights up when setting the off timer.

5 Bucket Indicator

- Lights up when the bucket is full and bucket is out of the product for more than 5 minutes.

6 Status Display

- Displays the desired humidity when setting the humidity, and displays the current humidity after about 5 seconds.
- The current humidity is displayed in 1 % units.
- If the indoor humidity is below 20 %, it will display 'Lo', and if it is above 90 %, it will display as 'Hi'.

7 Operation Mode

- Displays the currently set operation mode.

Operating the dehumidifier

Start/Stop

Press the **Start/Stop** button to turn the product on or off.

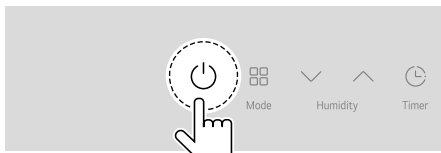

NOTE

- When you operate the product for the first time, it operate in **Smart+** mode.
- When you turn on the product, the desired humidity will be displayed for about 5 seconds. After that, the current humidity will be displayed.
- You can adjust fan speed by using the **LG ThinQ** application.
- You can adjust the airflow by using the **LG ThinQ** application.

Operating Mode

Press the **Mode** button to select the mode.

- If you press the **Mode** button during operation, the mode will change in the order of **Smart+** → **Silent** → **Laundry** → **Spot**.

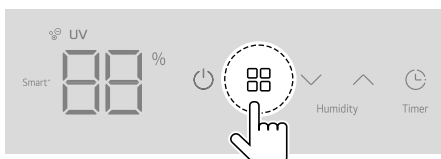

Smart+ Mode

Use when you want to maintain pleasant indoor condition.

- Press **Mode** button to select **Smart+** mode.

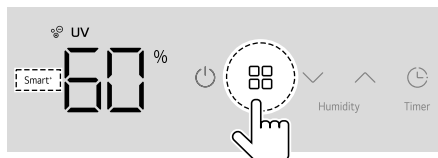

NOTE

- Once the humidity level reaches the desired humidity, the compressor stops and only the fan operates. If relative humidity goes up, it will operate dehumidification again.
- The fan speed is set based on the indoor humidity and desired humidity.
- You can adjust the fan speed using **LG ThinQ** application.

Silent Mode

Use when you want to operate dehumidification function quietly.

- Press **Mode** button to select **Silent** mode.

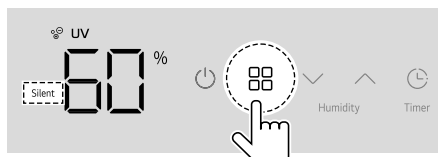

NOTE

- You can adjust the fan speed using **LG ThinQ** application.

Laundry Mode

Use when you want to dry laundry continuously regardless of the ambient humidity.

- Press **Mode** button to select **Laundry** mode.

18 OPERATION

- When using the **Laundry** mode, P₀ is displayed on the status display for a moment.

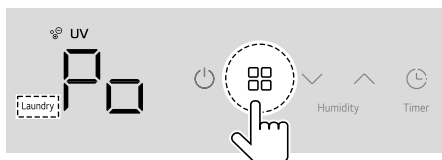

⚠ CAUTION

- When drying laundry, be careful not to allow water from the laundry to enter the dehumidifier.

NOTE

- The fan speed is set to high at default and you can not adjust the fan speed and desired humidity.
- When using **Laundry** mode, louver operates up and down.

Spot Mode

Use when spot drying is needed, such as shoes, closet, etc.

- Press **Mode** Button to select **Spot** mode.

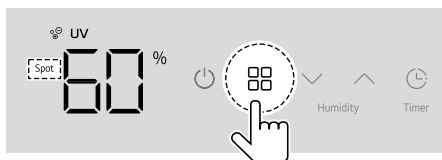

⚠ CAUTION

- In **Spot** mode, the louver is opened. Please do not close.
- If you try to close the louver in **Spot** mode, the product overloads and may display an error message.

NOTE

- The air coming out of the extension hose is dehumidified air.

- Use the product by connecting shoes drying kit/laundry drying kit through the extension hose as necessary.

How to use Spot Mode

- 1 Open the hose cover at the back of the product by pressing the left triangle of the hose cover.

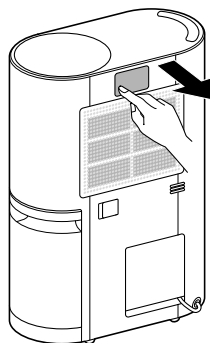

- 2 After inserting extension hose adapter, fix it by turning it clockwise until it clicks.

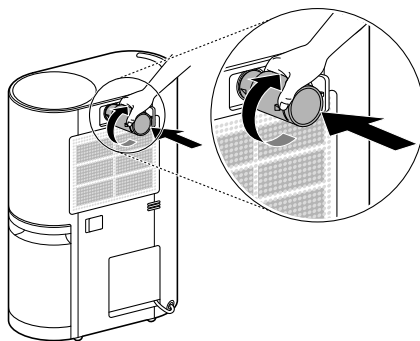

- 3 Attach the shoes drying kit/laundry drying kit to the extension hose.
 - When attaching or removing the shoes drying kit/laundry drying kit, make sure the

triangle markings are facing the same direction.

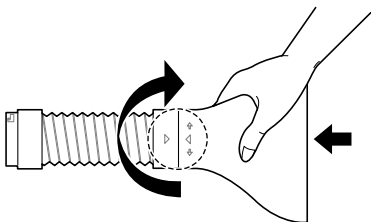

- 4** After inserting extension hose into the extension hose adapter, fix it by turning it clockwise.

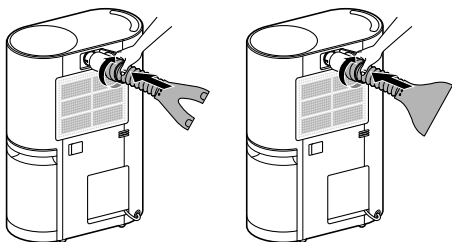

- 5** Extend the hose to make it face the desired drying direction.

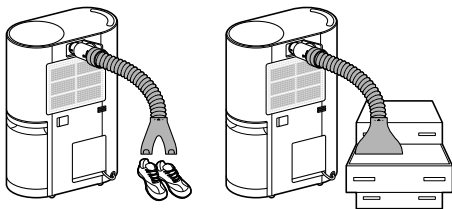

⚠ CAUTION

- Do not move the dehumidifier by holding the extension hose.

Adjusting the Humidity

Press the **Humidity** ∇/\blacktriangle button to change the humidity.

- If you press the **Humidity** ∇/\blacktriangle button, the desired humidity will change in the order of 30 \leftrightarrow 35 \leftrightarrow 40 \leftrightarrow 45 \leftrightarrow 50 \leftrightarrow 55 \leftrightarrow 60 \leftrightarrow 65 \leftrightarrow 70.

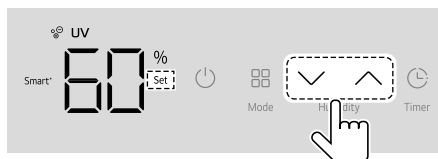

NOTE

- Humidity can be set with the units of 5 %.
- While setting the humidity, desired humidity is displayed on the status display and the current humidity is displayed after about 5 seconds.

Using the Extra Functions

Defrost Operation

If there is frost in the heat exchanger due to low indoor temperature, it automatically removes the frost.

- During the operation, if **dF** is displayed on the status display, it automatically removes the frost from the heat exchanger inside the product.

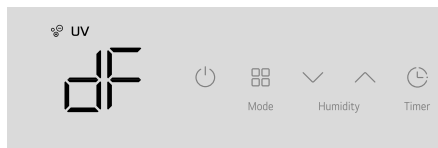

NOTE

- Compressor is stopped during the automatic defrost operation.

Auto Clean

This function dries inside of the dehumidifier.

- Press the **Mode** button for 3 seconds during operation to set up **Auto Clean**.

When the **Auto Clean** function is set,  is displayed on the status display for a moment.

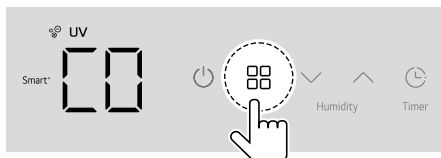

- When running the **Auto Clean**, the remaining operating time is displayed on the status display.

NOTE

- To turn off the **Auto Clean** function, press the **Mode** button for 3 seconds.
- After **Auto Clean** function finishes, the status display automatically turns off.
- When the operation stops, the **Auto Clean** will start.
- When running the **Auto Clean**, you can not adjust the remaining operating time.
- The **Auto Clean** function is running the fan for a certain period of time. Using the **LG ThinQ** application, you can set the fan operating time.

Bucket Lighting Function

Turns on the light to see inside the bucket clearly.

- Press the **Humidity**  button for 3 seconds to set the bucket lighting function.

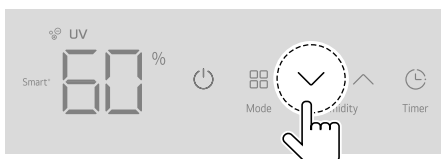

NOTE

- Using the **LG ThinQ** application, you can change the lighting color and brightness.

Lock Function

Lock the buttons on the control panel to prevent the appliance from operating due to unforeseen reasons, such as a child manipulating the buttons.

- Press the **Humidity**  button for 3 seconds to set Lock/Unlock Function.

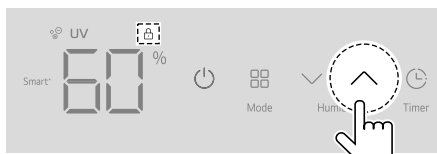

NOTE

- After setting the lock function, the current operating status will be maintained until the lock function is turned off.
- If you press other buttons while the lock function is set, a warning sound sounds 3 times.
- You can set the function regardless of whether the product is in operation.

Timer Function

This function schedules the time to turn off the product.

- Press the **Timer** button to set the timer function.
 - Each time you press the **Timer** button, the timer changes in the order of 1 → 2 → ... → 8 → Cancel.

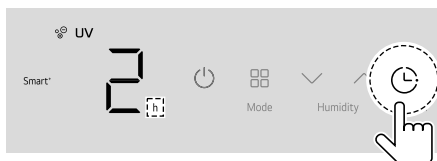

NOTE

- To see the remaining time, press the **Timer** button after the humidity is displayed on the status display.
- Set the timer after emptying the bucket. If the bucket is full while operating the product, the

Bucket indicator lights up and the product stops operating.

UVnano Function

The UVnano light illuminates the blower fan through which dehumidified air passes through, sterilizing 99.99 % of bacteria on the surface.

- Using the **LG ThinQ** application, set the UVnano function.

NOTE

- UVnano is a compound word of “UV” LEDs that reduce harmful bacteria and “nanometers”, as in the ultraviolet wavelength unit.
- The UV LED operates regularly to keep the fan clean.
- The UVnano function stops when the dehumidifier is turned off.
- The UVnano function is enabled by default when using the product for the first time.

Ionizer Function

When you want to remove harmful bacteria in the air.

- Using the **LG ThinQ** application, set Ionizer function.

NOTE

- It removes harmful material in the air such as bacteria, virus, etc. using ionized air.
- You can use Ionizer function and dehumidification function at the same time.
- Ionizer can be used at any time regardless of dehumidifier function.
- The Ionizer function is enabled by default when using the product for the first time.

Emptying the Bucket

Bucket Full

When the bucket is full, operation automatically stops, the Bucket indicator lights up and warning buzzer sounds. (Warning buzzer will sound one more time after 1 minute.)

- When the full water is detected, the dehumidification function immediately stops and fan operates for 5 minutes to remove the remaining condensed water in the heat exchanger.
- After emptying the bucket, when you insert the bucket again, the Bucket indicator turns off.

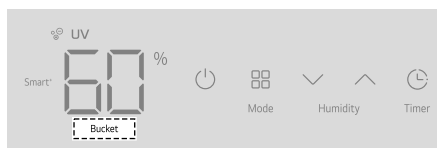

⚠ CAUTION

- If you pull the bucket too hard, the water inside may spill over, so pull it out carefully.
- When you take out the bucket, make sure to stop the product.
- If you take out the bucket during the operation, compressor will stop, and fan will operate for 5 minutes to vaporize the remaining condensed water in the heat exchanger before stopping the operation.

How to Empty the Bucket

- 1 Hold the top handle of the bucket and softly take it out.

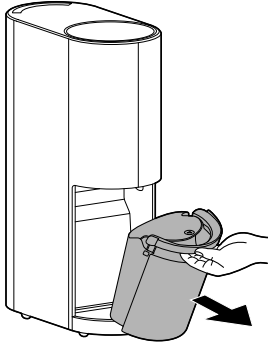

- 2 Press the push mark to open the bucket lid and discard the water.

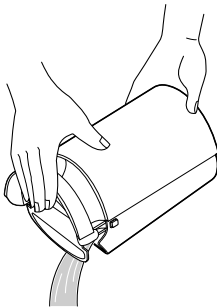

- 3 First insert the bottom part of the bucket correctly into the hole and then push it in.

- When inserting the bucket, do not put your hand over the bucket handle.

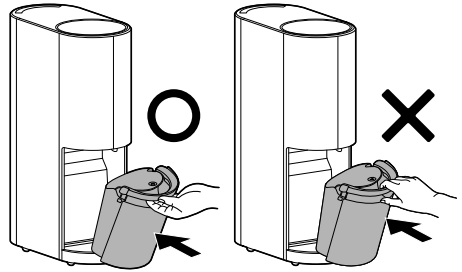

⚠ CAUTION

- After taking out the bucket, do not touch inside the main unit. It will cause failure of the full water detection device.
- Do not drink or reuse the water in the bucket.
- When you take out the bucket, make sure to stop the product.

NOTE

- If the bucket is taken out right after stopping the operation, there are cases of water remaining in the heat exchanger dropping into the main unit.
 - Wipe the dropped water with soft cloth.
- Periodically clean inside the bucket. (about 1 time per week).
- If it is used at low temperature, there is less moisture in the air, so dehumidification amount is also decreased.
- When you take out the bucket, make sure to stop the product. If you take out during operation, the compressor will stop and the fan operates for 5 minutes to vaporize the remaining condensed water inside the heat exchanger before complete stop.

How to Continuous Drainage Setup

Required items: 16mm (inner diameter) hose

- 1 Hold the top handle of the bucket and softly take it out.

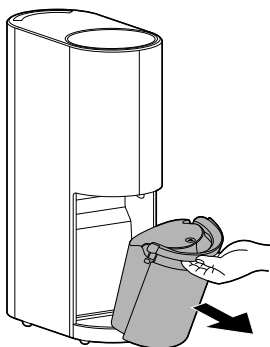

- 2 Open the drain cap connected to the continuous drain at the back of the product.

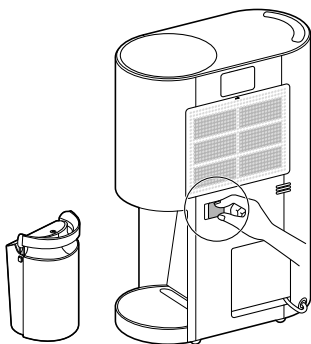

- 3 Insert the continuous drainage hose (1) into the continuous drainage hole and connect it to the drain hole on the product.

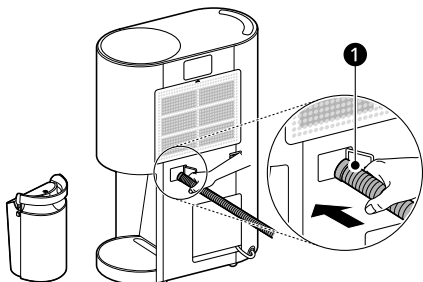

- 4 First insert the bottom part of the bucket correctly into the hole and then push it in.
- If the bucket is not inserted, the dehumidification does not operate.

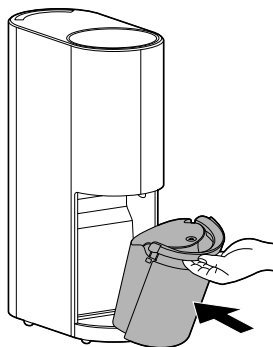

⚠ CAUTION

- Be careful of the cut part around the continuous drainage hole when connecting or separating the continuous drainage hose. The cut part is sharp and it may cause injury.
- Take care not to injure hands while connecting drainage hose.

NOTE

- The continuous drainage hose is sold separately. If you wish to use a commercial hose available in the market, use a hose whose internal diameter is 16mm.
- Check if the continuous drainage hose is connected to the drain hole on the product correctly.
 - If the continuous drainage hose is not connected to the drain hole on the product correctly, water may leak when dehumidification is carried out.
- How to connect the hose for continuous drainage
 - Do not bend the continuous drainage hose or soak it in water.

24 OPERATION

NOTE

- Keep a distance of at least 10cm from the drain.

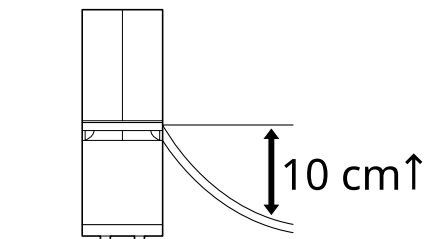

SMART FUNCTIONS

LG ThinQ Application

The **LG ThinQ** application allows you to communicate with the appliance using a smartphone.

LG ThinQ Application Features

Smart Diagnosis

If you experience a problem while using the appliance, this **Smart Diagnosis** feature will help you diagnose the problem.

Settings

Allows you to set various options on the appliance and in the application.

NOTE

- In the following cases, you must update the network information for each appliance in the **LG ThinQ** application under **Device Cards** → **Settings** → **Change Network**.
 - wireless router is changed
 - wireless router password is changed
 - Internet service provider is changed
- The application is subject to change for appliance improvement purposes without notice to users.
- Functions may vary by model.

Before Using LG ThinQ Application

This feature is only available on models with Wi-Fi function.

- 1 Check the distance between the appliance and the wireless router (Wi-Fi network).
 - If the distance between the appliance and the wireless router is too far, the signal strength becomes weak. It may take a long time to connect or installation may fail.

- 2 Turn off the Mobile data or Cellular Data on your smartphone.

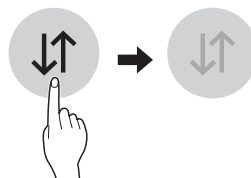

- 3 Connect your smartphone to the wireless router.

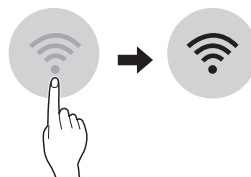

NOTE

- To verify the Wi-Fi connection, check that the Wi-Fi  icon on the status panel is lit.
- **The appliance supports 2.4 GHz Wi-Fi networks only.** To check your network frequency, contact your Internet service provider or refer to your wireless router manual.
- **LG ThinQ** is not responsible for any network connection problems or any faults, malfunctions, or errors caused by network connection.
- If the appliance is having trouble connecting to the Wi-Fi network, it may be too far from the router. Purchase a Wi-Fi repeater (range extender) to improve the Wi-Fi signal strength.
- The Wi-Fi connection may not connect or may be interrupted because of the home network environment.
- The network connection may not work properly depending on the Internet service provider.
- The surrounding wireless environment can make the wireless network service run slowly.

NOTE

- If the appliance cannot be connected due to problems with the wireless signal transmission, unplug the appliance and wait about a minute before trying it again.
- If the firewall on your wireless router is enabled, disable the firewall or add an exception to it.
- The wireless network name (SSID) should be a combination of English letters and numbers. (Do not use special characters.)
- Smartphone user interface (UI) may vary depending on the mobile operating system (OS) and the manufacturer.
- If the security protocol of the router is set to WEP, the network setup may fail. Change the security protocol (WPA2 is recommended) and connect the product again.

Installing the LG ThinQ Application

Search for the **LG ThinQ** application from the Google Play Store or Apple App Store on a smartphone. Follow instructions to download and install the application.

Open Source Software Notice Information

To obtain the source code that is contained in this product, under GPL, LGPL, MPL, and other open source licenses that have the obligation to disclose source code, and to access all referred license terms, copyright notices and other relevant documents, please visit <https://opensource.lge.com>.

LG Electronics will also provide open source code to you on CD-ROM for a charge covering the cost of performing such distribution (such as the cost of media, shipping, and handling) upon email request to opensource@lge.com.

This offer is valid to anyone in receipt of this information for a period of three years after our last shipment of this product.

Smart Diagnosis

Use this feature to help you diagnose and solve problems with your appliance.

NOTE

- For reasons not attributable to LGE's negligence, the service may not operate due to external factors such as, but not limited to, Wi-Fi unavailability, Wi-Fi disconnection, local app store policy, or app unavailability.
- The feature may be subject to change without prior notice and may have a different form depending on where you are located.

Using LG ThinQ to Diagnose Issues

If you experience a problem with your Wi-Fi equipped appliance, it can transmit troubleshooting data to a smartphone using the **LG ThinQ** application.

- Launch the **LG ThinQ** application and select the **Smart Diagnosis** feature in the menu. Follow the instructions provided in the **LG ThinQ** application.

Using Audible Diagnosis to Diagnose Issues

Follow the instructions below to use the audible diagnosis method.

- Launch the **LG ThinQ** application and select the **Smart Diagnosis** feature in the menu. Follow the instructions for audible diagnosis provided in the **LG ThinQ** application.

- 1 Press and hold the **Humidity** **V** and **^** buttons simultaneously for 3 seconds to execute the **Smart Diagnosis** function.

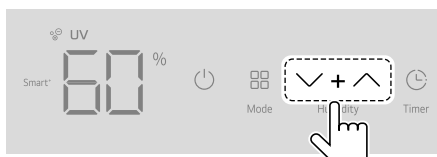

- 2 Place your smartphone near the product.
- Make sure the microphone of the smartphone faces the top of the product.

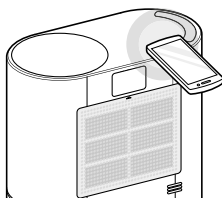

- 3 When data transmission is complete, the **Smart Diagnosis** result will be displayed on the **LG ThinQ** Application.

NOTE

- For accurate diagnosis, do not move the smartphone away from the product until the beeping stops.
 - Keep quiet around the product during **Smart Diagnosis**.
-

MAINTENANCE

Maintaining the Product

Cleaning the Exterior

- 1 Remove dust using a vacuum cleaner.

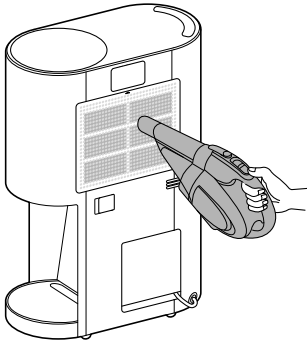

- 2 Wipe the air inlet and the exterior of the product with a soft cloth.

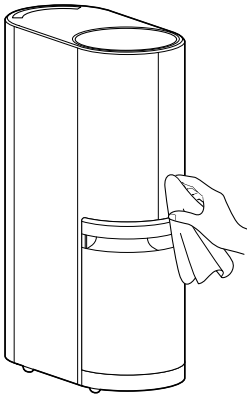

CAUTION

- Do not wipe the appliance with an alkaline detergent.
- Never use sulphuric acid, hydrochloric acid or organic solvent (e.g., thinner, kerosene and acetone) to wipe the appliance exterior, or affix

labels on the exterior. Doing so may damage the product surface.

- Care should be exercised to prevent flowing of water into the product.

Cleaning the Bucket

- 1 Press the fixing part on both sides of the bucket to take out the lid.

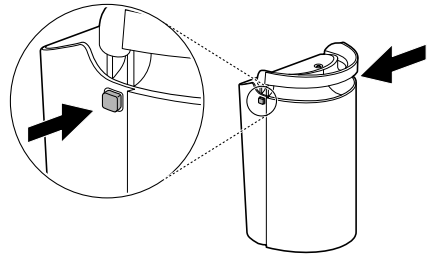

- 2 Wipe the water inside the bucket.

- Do not open the lid because there is a float (1) to detect full water inside.

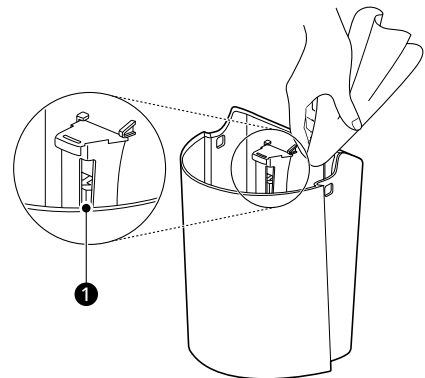

NOTE

- If the float is fallen off or assembled incorrectly, there may be water leakage.

- Do not use hot water, detergent, air fresheners, surfactants, antistatic agents, etc. It may damage the exterior of the product.

- 4 Completely dry the filter in shade, reassemble the filter and filter cover to the product.

Cleaning the Filters

- 1 Press the top of the filter cover to remove the filter cover from the product.

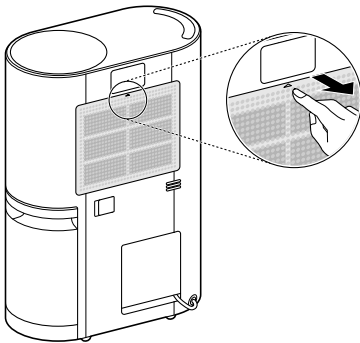

- 2 Remove the filter from the product.
 - You can separate the pre-filter by pulling the handle at the center of the pre-filter.

- 3 Clean the filter with vacuum cleaner or soft brush.
 - If the contamination is severe, wash with water using neutral detergent. (Do not use hot water of 40 °C or higher.)
 - The cleaning period for pre-filter is 1 month.

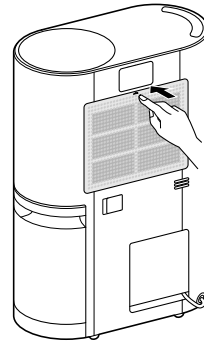
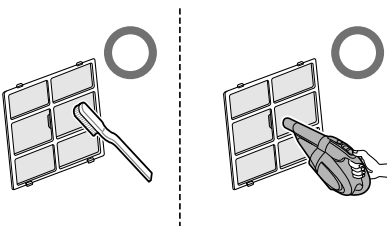

CAUTION

- For the safety, pull out the power plug before cleaning.
- Be careful not to damage the Pre-Filter when using a vacuum cleaner.
- After washing the Pre-Filter with water, completely dry it in shadow.
- Wear gloves when cleaning the Product and removing the filter cover, and be careful not to injure yourself on sharp parts (such as the heat exchanger).
- Do not clean the heat exchanger arbitrarily. Doing so may result in injury.

Storage

Storing the Product

If the product will not be used for a long period of time, store it in a dry and shaded place.

- 1 Turn off the product and unplug the power cord from the outlet. Press the triangle mark in the left center of the power plug storage door to open the power plug storage and organize the power plug as follows.

30 MAINTENANCE

- Organize the power cord using the Velcro attached to the power plug.

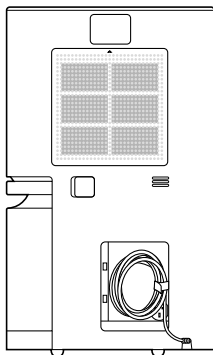

⚠ CAUTION

- Do not store the appliance at a humid place or at a place exposed to the direct sunlight. Otherwise the appliance may be deformed, malfunction or generate odor.
 - If the product is stored with water remaining in the bucket, odor and mold may occur.
-

2 Completely drain the water remaining inside the bucket.

- Separate the bucket lid and wipe the water inside the bucket.

3 Clean the filter.

- If it is dried under sunlight, it may be deformed.
- During the drying, avoid fire or direct sunlight, but dry in shadow.

4 Package the appliance to prevent the dust or foreign substance from entering the appliance. Store the packaged product at a shaded place.

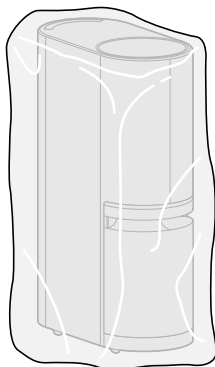

TROUBLESHOOTING

Before Calling for Service

Please check the following before calling for service. If the problem persists, contact your local service center.

Normal Operating Sounds of the Product

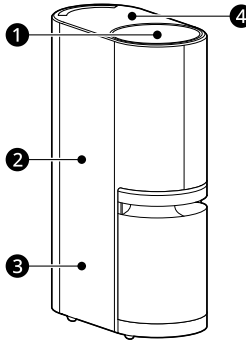

① Sound of wind

The volume of sound changes according to the angle of the louver.

② 'Buzzing' and 'grr-grr' (grinding) sounds

Sound may be heard until the circulation of the refrigerant stabilizes.

③ High frequency sound

The sound from the inverter compressor is a normal sound that occurs during operation.

④ 'Clack' sounds (part expansion sound)

When operating the dehumidifier, the sound is temporary due to temperature changes in the components and disappears after a certain period of time.

Operation

Call the service immediately in the following situations.

- Power cord is too hot or damaged.
- Error code is generated by self diagnosis.
- Water overflow even if the bucket is full.

Symptoms	Possible Cause & Solution
The appliance does not operate.	Is the power plug disconnected? <ul style="list-style-type: none"> • Connect it to an outlet correctly.

Symptoms	Possible Cause & Solution
The appliance does not operate.	Did the electricity get cut off? <ul style="list-style-type: none"> • Check the power to other products in the house.
	Is the bucket correctly installed? <ul style="list-style-type: none"> • Install the bucket correctly.
	Is the Bucket indicator light up? <ul style="list-style-type: none"> • Empty the bucket.
	Is the status display showing dF? <ul style="list-style-type: none"> • Defrost operation is in progress. Please select a mode once the defrost is complete.
	Is the desired humidity set higher than the room humidity? <ul style="list-style-type: none"> • Lower the desired humidity to below the room humidity.
There is little dehumidification.	Is the room temperature or humidity too low? <ul style="list-style-type: none"> • Check the target humidity. • Use Laundry mode. • It is normal for less dehumidification to take place in the winter and in dry areas.
	Is the air inlet or outlet blocked? <ul style="list-style-type: none"> • Remove the obstruction. • Clean the filter.
Humidity does not seem to decrease much even though the product is running in dehumidification mode.	Is the door/window open? <ul style="list-style-type: none"> • Close the door/window.
	Is the room too big? <ul style="list-style-type: none"> • Use the dehumidifier in an adequately sized room.
	Is there an object generating steam nearby? <ul style="list-style-type: none"> • Do not use the dehumidifier together with other appliances.
The humidity reading on the status display is incorrect.	Is the dehumidifier clogged in any way? <ul style="list-style-type: none"> • Keep the dehumidifier away from walls etc.
	Is the dehumidifier far away from the place you are trying to dehumidify? <ul style="list-style-type: none"> • The dehumidifier's display shows the humidity level in its current position, which may be different from the level in other positions.
It is taking a long time to dry laundry.	Is the dry air reaching the laundry? <ul style="list-style-type: none"> • Move the dehumidifier closer to the laundry.

Symptoms	Possible Cause & Solution
It is taking a long time to dry laundry.	Are you trying to dry the laundry in a large room? <ul style="list-style-type: none"> Use the dehumidifier in an adequately sized room.
	Are you trying to dry too much laundry? <ul style="list-style-type: none"> Reduce the amount of laundry.
I just removed the bucket and water is dripping from within the dehumidifier.	Did you remove the bucket while the dehumidifier was running? <ul style="list-style-type: none"> Remove the bucket when the Bucket indicator lights up.
The extension hose is not connected.	Is the extension hose adapter connected to the product? <ul style="list-style-type: none"> Check the extension hose adapter is connected.

LG ThinQ

Symptoms	Possible Cause & Solution
The product and the smartphone cannot be connected through Wi-Fi.	Is the Wi-Fi password used to connect to the smartphone correct? <ul style="list-style-type: none"> Press the Settings button on your smartphone, and then find your Wi-Fi in the network list. Press and hold the button to select [Clear Network], and then proceed with product registration again from the beginning.
	Is your smartphone using mobile data rather than Wi-Fi? <ul style="list-style-type: none"> In the smartphone's settings, turn off Mobile Data, turn on Wi-Fi, and then register the product.
	Does the name (ID) of the wireless router contain special characters? <ul style="list-style-type: none"> Set the name (ID) of the wireless router as a combination of numbers and English letters. Wi-Fi connection may be difficult if you enter special characters.
	Is the frequency of the wireless router not 2.4 GHz? <ul style="list-style-type: none"> When connecting the product via Wi-Fi, only a 2.4 GHz network can be used. Set the wireless router to 2.4 GHz and then connect. To check the frequency of your wireless router, contact your Internet carrier or router manufacturer.
	Are the product and the wireless router too far apart? <ul style="list-style-type: none"> If the distance between the product and the wireless router is too great, the wireless signal may be weak, and the connection may not be smooth. Move the wireless router closer to the product.

APPENDIX

Information

APPLIANCE SPECIFICATIONS

- Appearance and specifications may vary without notice to improve the quality of the appliance.

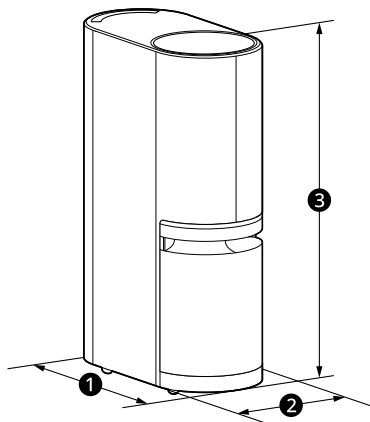

Name	DD**GM*E*
Power	AC 220 V ~, 50 Hz
Exterior Dimensions (1 x 2 x 3)	410 mm x 210 mm x 640 mm