



OWNER'S MANUAL

Wireless Sound Bar

Please read this manual carefully before operating your set and retain it for future reference.

MODEL

SK4D (SK4D, SPH4B-W)

www.lg.com

Copyright © 2018-2019 LG Electronics Inc. All Rights Reserved.
1904_Rev02

Safety Information



CAUTION: TO REDUCE THE RISK OF ELECTRIC SHOCK DO NOT REMOVE COVER (OR BACK) NO USER-SERVICEABLE PARTS INSIDE REFER SERVICING TO QUALIFIED SERVICE PERSONNEL



This lightning flash with arrowhead symbol within an equilateral triangle is intended to alert the user to the presence of uninsulated dangerous voltage within the product's enclosure that may be of sufficient magnitude to constitute a risk of electric shock to persons.



The exclamation point within an equilateral triangle is intended to alert the user to the presence of important operating and maintenance (servicing) instructions in the literature accompanying the product.

WARNING: TO PREVENT FIRE OR ELECTRIC SHOCK HAZARD, DO NOT EXPOSE THIS PRODUCT TO RAIN OR MOISTURE.

CAUTION: The apparatus should not be exposed to water (dripping or splashing) and no objects filled with liquids, such as vases, should be placed on the apparatus.

WARNING: Do not install this equipment in a confined space such as a book case or similar unit.

CAUTION: Do not use high voltage products around this product. (ex. Electrical swatter) This product may malfunction due to electrical shock.

CAUTION: No naked flame sources, such as lighted candles, should be placed on the apparatus.

CAUTION: Do not block any ventilation openings. Install in accordance with the manufacturer's instructions.

Slots and openings in the cabinet are provided for ventilation and to ensure reliable operation of the product and to protect it from over heating. The openings should never be blocked by placing the product on a bed, sofa, rug or other similar surface. This product shall not be placed in a built-in installation such as a bookcase or rack unless proper ventilation is provided or the manufacturer's instruction has been adhered to.

CAUTION concerning the Power Cord

The Power Plug is the disconnecting device. In case of an emergency, the Power Plug must remain readily accessible.

Check the specification page of this owner's manual to be certain of the current requirements.

Do not overload wall outlets. Overloaded wall outlets, loose or damaged wall outlets, extension cords, frayed power cords, or damaged or cracked wire insulation are dangerous. Any of these conditions could result in electric shock or fire. Periodically examine the cord of your device, and if its appearance indicates damage or deterioration, unplug it, discontinue use of the device, and have the cord replaced with an exact replacement part by an authorized service center. Protect the power cord from physical or mechanical abuse, such as being twisted, kinked, pinched, closed in a door, or walked upon. Pay particular attention to plugs, wall outlets, and the point where the cord exits the device.

NOTICE: For safety marking information including product identification and supply ratings, please refer to the main label on the bottom or the other surface of the product.

This device is equipped with a portable battery or accumulator.

How to Safely remove the batteries or the battery pack from the equipment: To Remove the old batteries or battery pack, follow the assembly steps in reverse order. To prevent contamination of the environment and bring on possible threat to human and/or animal health, the old batteries or the battery pack must be put in an appropriate container at designated collection points. Do not dispose of batteries or battery pack together with other waste. It is recommended that you use local, free reimbursement systems batteries or battery packs, (may not be available in your area). The batteries or the battery pack should not be exposed to excessive heat such as sunshine, fire or the like.

For models using an adapter

Only use the AC adapter supplied with this device. Do not use a power supply from another device or another manufacturer. Using any other power cable or power supply may cause damage to the device and void your warranty.

Symbols

~	Refers to alternating current (AC).
≡	Refers to direct current (DC).
⊞	Refers to class II equipment.
⏻	Refers to stand-by.
I	Refers to "ON" (power).
⚡	Refers to dangerous voltage.

Table of Contents

1 Getting Started

- 2 Safety Information
- 6 Unique features
- 6 Introduction
 - 6 – Symbols used in this manual
- 7 Remote control
- 8 Front panel
- 8 Rear panel
- 9 About LED condition
- 11 Installing the sound bar

2 Connecting

- 12 Connecting the AC Adapter
- 12 Wireless subwoofer connection
- 14 Connecting to your TV
 - 14 – Using an OPTICAL cable
 - 14 – LG Sound Sync
- 16 Optional equipment connection
 - 16 – OPTICAL IN connection
 - 17 – USB connection
 - 17 – Compatible USB devices
 - 17 – USB device requirement
 - 18 – Playable file

3 Operating

- 19 Basic operations
 - 19 – USB operation
- 19 Other operations
 - 19 – Turn off the sound temporarily
 - 19 – Using your TV remote control
 - 20 – Auto display Dimmer
 - 20 – Auto power down
 - 20 – AUTO POWER On/Off
 - 21 – Auto function change
- 22 Using BLUETOOTH® technology
 - 22 – Listening to music stored on the BLUETOOTH devices
 - 23 – BLUETOOTH connection lock (BT lock)
- 24 Using BLUETOOTH App
 - 24 – Install “Music Flow Bluetooth” App onto Your BLUETOOTH Device
 - 24 – Activate BLUETOOTH with “Music Flow Bluetooth” App
- 26 Sound adjustment
 - 26 – Setting sound effect
 - 26 – Adjust the woofer level settings
 - 26 – Night mode

4 Troubleshooting

- 27 Troubleshooting
 - 27 – General
 - 28 – NOTES to use wireless

5 Appendix

- 29 Trademarks and licenses
- 30 Specifications
- 31 Maintenance
 - 31 – Handling the unit

1

2

3

4

5

Unique features

Auto power down

This unit will turn off by itself for energy saving consumption.

LG Sound Sync

Controls volume level of this unit by the remote control of your LG TV that is compatible with LG Sound Sync.

BLUETOOTH®

Listen to music stored on your **Bluetooth** device.

USB playback

Listen to music stored on your USB device.

Introduction

Symbols used in this manual

Note

Indicates special notes and operating features.

Caution

Indicates cautions for preventing possible damages from abuse.

Remote control

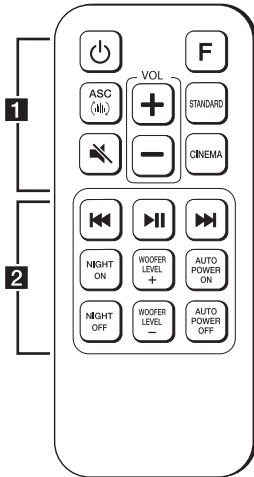

Replacement of Battery

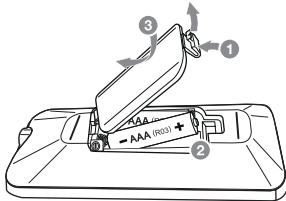

Remove the battery cover on the rear of the remote control, and insert the battery with and matched correctly.

1

(Power) : Switches the unit ON or OFF.

F (Function) : Selects the function and the input source.

ASC : Analyzes the property of input sound and provides the sound optimized for the content in real time.

(Mute) : Mutes the sound.

VOL (Volume) / : Adjusts speaker volume.

STANDARD : Selects standardized sound.

CINEMA : Selects cinematic surround sound.

2

/ (Skip/Search) :

- Skips Fast backward or Forward.
- Searches for a section within a file.

(Play/Pause) : Starts playback. / Pauses playback.

NIGHT ON/OFF :

- Turns on or off Night mode.
- Controls this unit using TV remote. (Page 19)

WOOFER LEVEL / : Adjusts sound level of subwoofer.

AUTO POWER ON/OFF :

- Turns on or off AUTO POWER function. (Page 20)
- Turns on or off the **Bluetooth** connection lock. (Page 23)

Front panel

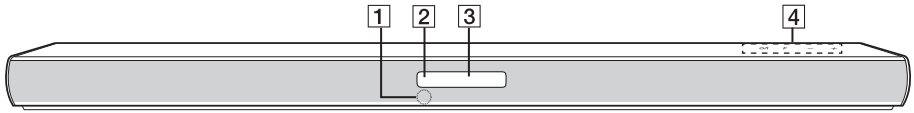

- 1 Remote sensor
- 2 Standby LED (Red)
- 3 Function LED (White)
- 4 The buttons are located on the rear.

Rear panel

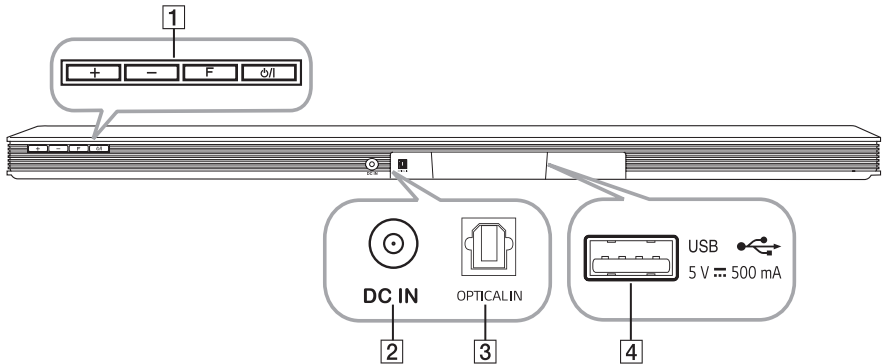

- 1 **+/-** (Volume) : Adjusts volume level
- F** (Function) : Selects the function and input source.
- ⏻/⏻** (Standby/On)
- 2 **DC IN** : AC adapter input
- 3 **OPTICAL IN** : Optical input
- 4 **USB**  : Connect to a USB device

About LED condition

● : LED is staying on.

☀ : LED is blinking.

○ : LED is off.

LED	Condition	Description
OPTICAL USB BT LG TV ● ○ ○ ○	OPTICAL LED turns on.	OPTICAL function is selected.
OPTICAL OPTICAL ☀ → ●	OPTICAL LED blinks twice and turns on.	LG Sound Sync (Optical) function is selected.
OPTICAL USB BT LG TV ○ ● ○ ○	USB LED turns on.	USB function is selected.
OPTICAL USB BT LG TV ○ ☀ ○ ○	USB LED blinks.	Paused USB playback.
OPTICAL USB BT LG TV ○ ○ ● ○	BT (Bluetooth) LED turns on.	Paired with Bluetooth device.
OPTICAL USB BT LG TV ○ ○ ☀ ○	BT (Bluetooth) LED blinks.	Waiting for Bluetooth connection.
OPTICAL USB BT LG TV ○ ○ ○ ●	LG TV LED turns on.	LG Sound Sync (Wireless) function is selected.

! Note

- When you press any button, standby LED (Red) on the main unit blinks.
- When you press  (Mute) button, standby LED (Red) blinks slowly.
- When this unit reaches minimum volume, standby LED (Red) turns on for 2 seconds and blinks slowly.
- When this unit reaches maximum volume, standby LED (Red) turns on for 2 seconds.
- When you press volume (+/-) button continually, standby LED (Red) blinks quickly.

Useful functions for using the unit

Function	Description	To do	Do this
TV Remote On/Off (Page 19)	It allows you to control the volume of this unit by your TV remote control even by other company's product. Initial setting of this function was set to on.	ON	Press and hold NIGHT ON on the remote control for about 2 seconds. The standby LED (Red) blinks once.
		OFF	Press and hold NIGHT OFF on the remote control for about 2 seconds. The standby LED (Red) blinks once.
BT Lock On/Off (Page 23)	It allows you to connect a Bluetooth device only on Bluetooth and LG TV functions. Initial setting of this function was set to off.	ON	Press and hold AUTO POWER ON on the remote control for about 2 seconds in Bluetooth function. The standby LED (Red) blinks once.
		OFF	Press and hold AUTO POWER OFF on the remote control for about 2 seconds in Bluetooth function. The standby LED (Red) blinks once.
Auto Power On/Off (Page 20)	It allows the unit to turn on and off automatically by input signals : Optical, LG TV or Bluetooth . Initial setting of this function was set to on.	ON	Press AUTO POWER ON on the remote control. The standby LED (Red) blinks once.
		OFF	Press AUTO POWER OFF on the remote control. The standby LED (Red) blinks once.

Installing the sound bar

You can hear the sound by connecting the unit to the other device : TV, Blu-ray disc player, DVD player, etc.

Place the unit in front of the TV and connect it to the device you want. (Pages 14 - 16)

You can place the wireless subwoofer anywhere in your room. But it is better to place the subwoofer near the main unit. Turn it slightly toward the center of the room to reduce the wall reflections.



⚠ Caution

- For best performance of wireless connection such as **Bluetooth** or wireless subwoofer, do not install the unit on Metallic furniture because wireless connection communicates through a module positioned on the bottom of the unit.
- Be careful not to make scratches on the surface of the Unit / Subwoofer when installing or moving them.

! Note

For the convenient button usage, it is recommended to have some distance between the soundbar and your TV when you install the sound bar.

Connecting the AC Adapter

Connect the speaker to the power supply with the supplied AC adapter.

1. Connect the supplied AC power cord to the AC adapter.
2. Connect the AC adapter cable to DC IN adapter input.
3. Plug the AC power cord into an AC outlet.

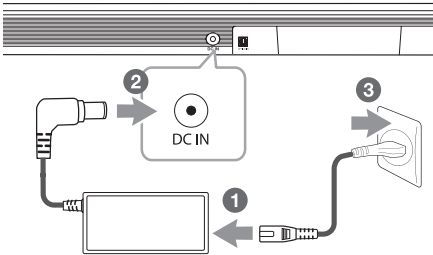

Caution

Only use the AC adapter supplied with this device. Do not use a power supply from another device or manufacturer. Using any other power cable or power supply may cause damage to the device and void your warranty.

Wireless subwoofer connection

LED indicator of wireless subwoofer

LED Color	Status
Yellow green (Blink)	The connection is trying.
Yellow green	The connection is completed.
Red	The wireless subwoofer is in standby mode or the connection failed.
Off (No display)	The power cord of wireless subwoofer is disconnected.

Setting up the wireless subwoofer for the first time

1. Connect the power cord of the sound bar and the wireless subwoofer to the outlet.
2. Turn on the sound bar: The sound bar and the wireless subwoofer will be **automatically** connect.

Manually pairing wireless subwoofer

When your connection is not completed, you can check red LED on the wireless subwoofer and the wireless subwoofer does not make sound. To solve the problem, follow the steps below.

1. Press **PAIRING** on the rear of the wireless subwoofer.

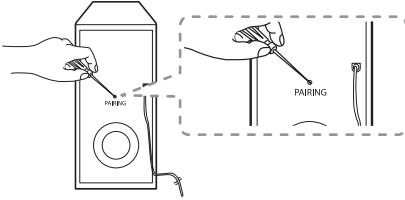

- The yellow green LED on the front of the wireless subwoofer blinks quickly. (If the yellow green LED does not blink, press and hold the **PAIRING**.)
2. Turn on the sound bar
 3. Pairing is completed.
 - The yellow green LED on the front of the wireless subwoofer turns on.

! Note

- It takes a few seconds (and may take longer) for the main unit and the subwoofer to communicate with each other and make sounds.
- The closer the main unit and the subwoofer, the better sound quality. It is recommended to install the main unit and the subwoofer as close as possible and avoid the cases below.
 - There is an obstacle between the main unit and the subwoofer.
 - There is a device using same frequency with this wireless connection such as a medical equipment, a microwave or a wireless LAN device.
 - Keep the sound bar and the subwoofer away from the device (ex. wireless router, microwave oven, etc.) over 1 m to prevent wireless interference.

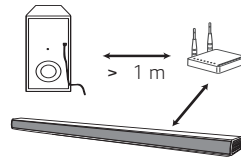

Connecting to your TV

Using an OPTICAL cable

1. Connect the OPTICAL IN jack on the back of the unit to OPTICAL OUT jack on the TV using an OPTICAL cable.

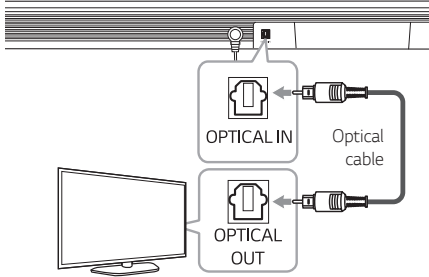

2. Select the input source to OPTICAL by pressing **F** repeatedly. You can see OPTICAL LED turns on. Then optical function is selected.

! Note

- Before connecting the optical cable, be sure to remove the protection plug cover if your cable has the cover.
- You can enjoy the TV audio through the speakers of this unit. In the case of some TV models, you must select the external speaker option from the TV menu. (For details, reference your TV user manual.)
- Set up the sound output of TV to listen to the sound through this unit :
TV setting menu → [Sound] → [TV Sound output] → [External speaker (Optical)]
- Details of TV setting menu vary depending on the manufacturers or models of your TV.

LG Sound Sync

Sound Sync
Wireless

You can control some functions of this unit by your TV's remote control with LG Sound Sync. It is compatible with the LG TV that supports LG Sound Sync. Make sure of the LG Sound Sync logo on your TV.

Controllable function by LG TV's remote control :
Volume up/down, mute

Refer to the TV's instruction manual for the details of LG Sound Sync.

Make one of the following connections, depending on the capabilities of your equipment.

! Note

- You can also use the remote control of this unit while using LG Sound Sync. If you use TV's remote control again, the unit synchronizes with the TV. According to TV Specifications, the volume and mute of this unit synchronize with TV.
- When the connection fails, make sure of the condition of the TV and power.
- Make sure of the condition of this unit and the connection in the cases below when using LG Sound Sync.
 - The unit is turned off.
 - Changing the function to the others.
 - Disconnecting the optical cable.
- The amount of time to turn off this unit is different depending on your TV when you set AUTO POWER function to ON.
- Details of TV setting menu vary depending on the models of your TV.

LG Sound Sync with wired connection

1. Connect your LG TV to the unit by using an optical cable.

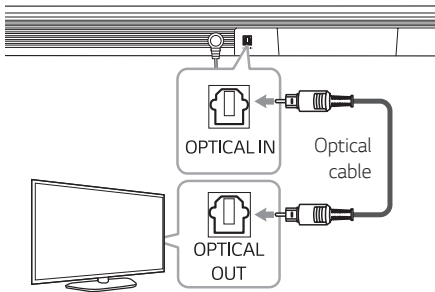

2. Set up the sound output of TV to listen to the sound through this unit :
TV setting menu → [Sound] → [TV Sound output] → [LG Sound Sync (Optical)]
3. Turn on the unit by pressing on the remote control or on the unit.
4. Select the input source to OPTICAL by pressing **F** repeatedly.
You can see OPTICAL LED blinks twice and turns on. Then LG Sound Sync (Optical) function is selected.

LG Sound Sync with wireless connection

1. Turn on the unit by pressing on the remote control or on the unit.
2. Select the input source to LG TV by pressing **F** repeatedly.
3. Set up the sound output of TV to listen to the sound through this unit :
TV setting menu → [Sound] → [TV Sound output] → [LG Sound Sync (Wireless)]
You can see LG TV LED turns on if connecting normally between this unit and your TV. Then LG Sound Sync (Wireless) function is selected.

Note

If you turned off the unit directly by pressing on the remote control or on the unit, LG Sound Sync (Wireless) will be disconnected. To use this function again, you should reconnect the TV and the unit.

USB connection

Connect USB memory device to the USB port on the back of the unit.

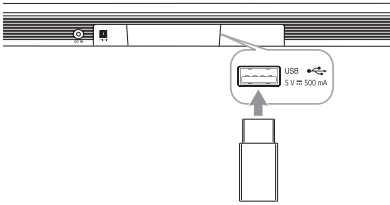

For more information of playing files on a USB, refer to the page 19.

Removing the USB Device from the unit.

1. Choose a different function/mode.
2. Remove the USB device from the unit.

Compatible USB devices

- MP3 Player : Flash type MP3 player.
- USB Flash Drive : Devices that support USB 1.1.
- The USB function of this unit does not support some USB devices.

USB device requirement

- Devices which require additional program installation connected to a computer, are not supported.
- Do not extract the USB device while in operation.
- For a large capacity USB, it may take longer than a few minutes to be searched.
- To prevent data loss, back up all data.
- This unit is not supported when the total number of files is 1,000 or more.
- The unit's USB Port can not be connected to PC. The unit can not be used as a storage device.
- The exFAT file system is not supported on this unit. (FAT16/FAT32 systems are available.)
- Depending on some devices, it may not available to recognize the followings on this unit.
 - External HDD
 - Card readers
 - Locked devices
 - Hard type USB devices
 - USB hub
 - Using USB extension cable
 - iPhone/iPod/iPad
 - Android device

Playable file

Sampling Frequency

MP3 : within 32 to 48 kHz

WMA : within 32 to 48 kHz

Bitrate

MP3 : within 80 to 320 kbps

WMA : within 56 to 128 kbps

- Maximum files : Under 999
- Maximum directories : Under 99
- A protected file by DRM (Digital rights management) cannot be played on the unit.
- Video files in the USB storage device can not be played.
- Depending on the performance of your USB device, playback may not work well.

! Note

- Folders and files on the USB are recognized as below.

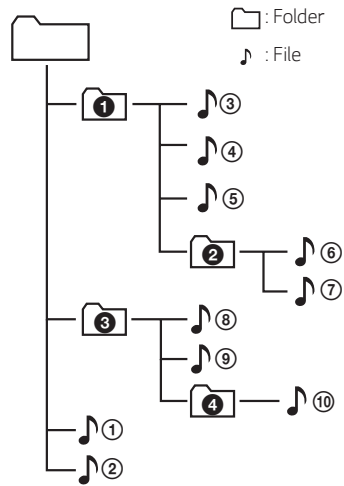

- File will be played from file ① to file ⑩ one by one.
- Files will be played in order recorded and it may be different depending on the record circumstances.
- You can't see a folder or file through this unit.

Basic operations

USB operation

1. Connect the USB device to the USB port.
2. Select the input source to USB by pressing **F** repeatedly.
You can see USB LED turns on. Then USB function is selected.

To	Do this
Playback	Press ▶ on the remote control.
Pause	During playback, press ▶ on the remote control.
Skip to the next/ previous file	During playback, press ▶▶ on the remote control to go to the next file. Playing less than 2 seconds, press ◀◀ on the remote control to go to the previous file. Playing after 3 seconds, press ◀◀ on the remote control to go to the beginning of the file.
Search for a section within a file	Press and hold ◀◀/▶▶ on the remote control during playback and release it at the point you want to listen to.
Resume playback	This unit memorizes a current song which is played before changing the function or turning off the unit.

! Note

- The resume point may be cleared when you pull out the power cord or removing the USB device from the unit.
- If the USB function is not working, check the USB function is selected.
- When you pause the USB playback, USB LED on the main unit blinks.

Other operations

Turn off the sound temporarily

Press **⏸**(Mute) to mute your unit.

To cancel it, press **⏸**(Mute) again on the remote control or change the volume level.

Using your TV remote control

You can control some functions of this unit by your TV remote control even by other company's product. Controllable functions are volume up/down and mute.

Press and hold **NIGHT ON** on the remote control for about 2 seconds. Then the standby LED (Red) blinks once and you can control this unit by your TV remote control.

To turn off this function, press and hold **NIGHT OFF** on the remote control for about 2 seconds. Then the standby LED (Red) blinks once and you cannot control this unit by your TV remote control.

! Note

- Supported TV brands

LG	Panasonic	Philips	Samsung
Sharp	Sony	Toshiba	Vizio

- Make sure that the sound output of your TV is set to [External speaker].
- Depending on the remote control, this function may not work well.
- This function does not operate on LG TV's magic remote control.
- This function may not work well when you use LG Sound Sync.

Auto display Dimmer

Display window will be darkened automatically if there is no key input for 15 seconds.

When you press any button, the display window will be brighten.

Auto power down

This unit will turn itself off to save electric consumption if the main unit is not connected to an external device and has not been used for 15 minutes.

How to disconnect the wireless network connection or the wireless device

Set up the AUTO POWER ON/OFF function to off and turn off the unit.

AUTO POWER On/Off

This unit automatically turns on by an input source : Optical, LG TV or **Bluetooth**.

When you turn on your TV or an external device connected to this unit, this unit recognizes the input signal and selects the suitable function. You can hear the sound from your device.

If you try to connect your **Bluetooth** device, this unit turns on and the unit will be connected to your **Bluetooth** device.

This function turns on or off each time you press **AUTO POWER ON/OFF**.

! Note

- After the unit is turned on by AUTO POWER function, it will be automatically turned off if there is no signal for a certain period of time from the external device.
- If you turned off the unit directly, it cannot be turned on automatically by AUTO POWER function. However the unit can be turned on by AUTO POWER function when optical signal comes in after 5 seconds of no signal.
- Depending on the connected device, this function may not operate.
- If you disconnect a **Bluetooth** connection with this unit, some **Bluetooth** devices try to continually connect. It is therefore recommended to disconnect the connection before turning off the unit.
- When you turn on this unit for the first time, status of Auto Power function is turned on.
- To use this function, the main unit must be registered in the paired devices list on the **Bluetooth** device.
- You can set the AUTO POWER function only when this unit is turned on.

Auto function change

This unit recognizes input signals such as Optical, **Bluetooth** and LG TV and then changes suitable function automatically.

When optical signal comes in

When you turn on the external device connected to this unit by an optical cable, this unit changes the function to optical. You can hear the sound from your device.

When you try to connect BLUETOOTH device

When you try to connect your **Bluetooth** device to this unit, **Bluetooth** function is selected. Play your music on the **Bluetooth** device.

When LG TV signal comes in

When you turn on your LG TV connected by LG Sound Sync (Wireless connection), this unit changes the function to LG TV. You can hear the sound from your TV.

Note

- To change to optical function, it needs 5 seconds of no signal.
- If the **Bluetooth** connection lock function is set, **Bluetooth** connection will be only available on BT (**Bluetooth**) and LG TV function. (Page 23)

Using BLUETOOTH® technology

About BLUETOOTH

Bluetooth is wireless communication technology for short range connection.

The sound may be interrupted when the connection interfered by the other electronic wave or you connect the **Bluetooth** in the other rooms.

Connecting individual devices under **Bluetooth** wireless technology does not incur any charges. A mobile phone with **Bluetooth** wireless technology can be operated via the Cascade if the connection was made via **Bluetooth** wireless technology.

- Available Devices : Smart phone, MP3, Notebook, etc..
- Version : 4.0
- Codec : SBC

BLUETOOTH Profiles

In order to use **Bluetooth** wireless technology, devices must be able to interpret certain profiles. This unit is compatible with following profile.

A2DP (Advanced Audio Distribution Profile)

Listening to music stored on the BLUETOOTH devices

Pairing your unit and BLUETOOTH device

Before you start the pairing procedure, make sure that the **Bluetooth** feature on your smart device is turned on. Refer to your **Bluetooth** device's user guide. Once a pairing operation is performed, it does not need to be performed again.

1. Select the input source to BT (**Bluetooth**) by pressing **F** repeatedly.
 - BT (**Bluetooth**) LED will blink.
2. Operate the **Bluetooth** device and perform the pairing operation. When searching for this speaker on your **Bluetooth** device, a list of the devices found may appear in the **Bluetooth** device display depending on the type of **Bluetooth** device. Your speaker appears as "LG SK4D (XX)":

Note

- XX means the last two digits of **Bluetooth** address. For example, if your unit has a **Bluetooth** address such as 9C:02:98:4A:F7:08, you will see "LG SK4D (08)" on your **Bluetooth** device.
- Depending on the **Bluetooth** device type, some device have a different pairing way. Enter the PIN code (0000) as needed.

3. When this unit is successfully connected with your **Bluetooth** device, BT (**Bluetooth**) LED will turn on.
4. Listen to music. To play a music stored on your **Bluetooth** device, refer to your **Bluetooth** device's user guide.

! Note

- When using **Bluetooth** technology, you have to make a connection between the unit and the **Bluetooth** device as close as possible and keep the distance. However it may not work well in the case below :
 - There is an obstacle between the unit and the **Bluetooth** device.
 - There is a device using same frequency with **Bluetooth** technology such as a medical equipment, a microwave or a wireless LAN device.
- If **Bluetooth** connection does not work well, try pairing it again.
- The sound may be interrupted when the connection has interference by the other electronic waves.
- Pairing is limited to one **Bluetooth** device per unit and multi-pairing is not supported.
- Depending on the type of the device, you may not be able to use the **Bluetooth** function.
- You can enjoy **Bluetooth** function using smart phone, MP3, Notebook, etc..
- The more distance between the unit and the **Bluetooth** device, the lower the sound quality becomes.
- **Bluetooth** connection will be disconnected when the unit is turned off or the **Bluetooth** device gets far from the unit.
- When **Bluetooth** connection is disconnected, connect the **Bluetooth** device to the unit again.

! Note

- When **Bluetooth** device is not connected, BT (**Bluetooth**) LED blinks.
- When you connect **Bluetooth** device (iOS device etc.) to this unit or operate the device, the volume level can be synchronized with each other.
- You can control **Bluetooth** device using **⏮/⏭** (Skip) and **⏸** (Play/Pause) on the remote control.
- If you change to another function after connecting **Bluetooth**, **Bluetooth** connection will be disconnected. And you return to **Bluetooth** function, **Bluetooth** connection will be connected automatically.

BLUETOOTH connection lock (BT lock)

You can limit **Bluetooth** connections to only BT (**Bluetooth**) and LG TV function to prevent unintended **Bluetooth** connections.

Press and hold **AUTO POWER ON** on the remote control for about 2 seconds to turn on this function in BT (**Bluetooth**) function. Then the standby LED (Red) blinks once. After that, this function is enabled.

To turn off this function, press and hold **AUTO POWER OFF** on the remote control for about 2 seconds in BT (**Bluetooth**) function. Then the standby LED (Red) blinks once. After that, this function is disabled.

! Note

Even if you set up **Bluetooth** connection lock to On, this sound bar turns on by Auto Power function. Turn off Auto Power function to prevent it. (Page 20)

Using BLUETOOTH App

! Note

- Only Android OS is available to use “Music Flow Bluetooth” app with this unit.
- Additional data charges may occur if installed over 3G/4G, according to your device plan.

About “Music Flow Bluetooth” App

“Music Flow Bluetooth” app brings a suite of new features to this unit.

To enjoy more features, you are recommended to download and install free “Music Flow Bluetooth” app.

Install “Music Flow Bluetooth” App onto Your BLUETOOTH Device

There are two ways to install “Music Flow Bluetooth” app onto your **Bluetooth** device.

Install “Music Flow Bluetooth” App through QR code

1. Install “Music Flow Bluetooth” app through QR code. Use the scanning software to scan the QR code.



2. Tap an icon for installation.

! Note

- Make sure that your **Bluetooth** device is connected to the Internet.
- Make sure that your **Bluetooth** device has a scanning software application. If you don't have one, download one from “Google Android Market (Google Play Store)”.
- Depending on area, QR code may not work.

Install “Music Flow Bluetooth” App through “Google Android Market (Google Play Store)”

1. Tap the “Google Android Market (Google Play Store)” icon.
2. In the search bar, type in the “Music Flow Bluetooth” and search it.
3. In the search result list, find and tap “Music Flow Bluetooth” to start downloading **Bluetooth** app.
4. Tap an icon for installation.
5. Tap an icon for downloading.

! Note

- Make sure that your **Bluetooth** device is connected to the Internet.
- Make sure that your **Bluetooth** device is equipped with “Google Android Market (Google Play Store)”.

Activate BLUETOOTH with “Music Flow Bluetooth” App

“Music Flow Bluetooth” app helps to connect your **Bluetooth** device to this unit.

1. Tap “Music Flow Bluetooth” app icon on the home screen to open “Music Flow Bluetooth” app, and go to the main menu.
2. If you want to get more information to operate, tap [Setting] and tap [Help] menu.

 **Note**

- “Music Flow Bluetooth” app will be available in the software version as follow;
 - Android O/S : Ver 4.0.3 (or later)
- If you use “Music Flow Bluetooth” app for operation, there would be some differences between “Music Flow Bluetooth” app and the supplied remote control. Use the supplied remote control as necessary.
- Depending on the **Bluetooth** device, “Music Flow Bluetooth” app may not work.
- After connection of “Music Flow Bluetooth” app, music may be output from your device. In this case, try connecting procedure again.
- If you operate the other applications or change the settings on your **Bluetooth** device while using “Music Flow Bluetooth” app, “Music Flow Bluetooth” app may operate abnormally.
- When “Music Flow Bluetooth” app operates abnormally, check your **Bluetooth** device and the connection of “Music Flow Bluetooth” app and then try to connect again.
- Depending on the smart phone's operating system, you have some differences for “Music Flow Bluetooth” operation.
- Even though **Bluetooth** connection will be disconnected, you can use “Music Flow Bluetooth” app when you change the function.
- Additional features offered by “Music Flow Bluetooth” app may not work depending on the distance between this unit and **Bluetooth** device and wireless conditions.

Sound adjustment

Setting sound effect

This system has a number of pre-set surround sound fields. You can select a desired sound mode by using each sound effect buttons.

Sound effect	Description
ASC (Adaptive Sound Control)	Analyzes the property of input sound and provides the sound optimized for the content in real time.
STANDARD	You can enjoy optimized sound.
CINEMA	You can enjoy more immersive and cinematic surround sound.

! Note

- In some of sound effect mode, some speakers, there's no sound or low sound. It depends on the mode of surround and the source of audio, it is not defective.
- You may need to reset the sound effect mode, after switching the input, sometimes even after the sound file changed.

Adjust the woofer level settings

You can adjust the sound level of subwoofer as your preference.

Press **WOOFER LEVEL** \pm on the remote control to adjust woofer level.

! Note

When the subwoofer level reaches maximum or minimum, standby LED (Red) on the main unit turns on for 2 seconds.

Night mode

This function is useful when you want to watch movies at low volume late at night. Set Night mode to On to reduce the sound intensity and improve fineness and softness.

Press **NIGHT ON/OFF** on the remote control to turn on or off night mode.

Troubleshooting

General

PROBLEM	CAUSE & CORRECTION
The unit does not work properly.	<ul style="list-style-type: none"> • Turn off the power of this unit and the connected external device (TV, Woofer, DVD-player, Amplifier, etc.) and turn them on again. • Disconnect the power cord of this unit and the connected external device (TV, Woofer, DVD-player, Amplifier, etc.) and then try connecting again. • Previous setting may not be saved when device power is shut off.
No Power	<ul style="list-style-type: none"> • The power cord is unplugged. Plug in the power cord. • Check whether electricity failed. Check the condition by operating other electronic devices.
No sound	<ul style="list-style-type: none"> • Incorrect input source is selected. Check the input source and select the correct input source. • The mute function is activated. Press  (Mute) or adjust the volume level to cancel the mute function. • When you are using connection with a external device (set top box, Bluetooth device etc.), adjust volume level of the device.
No woofer sound	<ul style="list-style-type: none"> • The power cord of the subwoofer is not connected. Plug the power cord into the wall outlet securely. • Pairing between the unit and the subwoofer gets disconnected. Connect the unit and the subwoofer. (Page 1 2)
The remote control does not work properly.	<ul style="list-style-type: none"> • The remote control is too far from the unit. Operate the remote control within about 7 m. • There is an obstacle in the path of the remote control and the unit. Remove the obstacle. • The batteries in the remote control is exhausted. Replace the batteries with new one.
The AUTO POWER function does not work.	<ul style="list-style-type: none"> • Check connection of the external device such as TV, DVD/Blu-Ray player or Bluetooth device. • Depending on the connected device, this function may not operate.
LG Sound Sync does not work.	<ul style="list-style-type: none"> • Check whether your LG TV supports LG Sound Sync. • Check connection of LG Sound Sync (Optical or wireless). • Check sound setting of your TV and this unit.

PROBLEM	CAUSE & CORRECTION
The unit does not connect with Bluetooth device	<ul style="list-style-type: none"> • Turn off the Bluetooth connection lock function. (Page 23)
When you feel the output sound of the unit is low.	<p>Check the details below and adjust the unit according to them.</p> <ul style="list-style-type: none"> • With the sound bar connected with TV, change the AUDIO DIGITAL OUT setting on TV Setup Menu from [PCM] to [AUTO] or [BITSTREAM]. • With the sound bar connected with Player; change the AUDIO DIGITAL OUT setting on Player Setup Menu from [PCM] to [PRIMARY PASS-THROUGH] or [BITSTREAM]. • Change Audio DRC setting on connected device setup menu to [OFF] state. • Make sure Night Mode is not On. Turn [OFF] Night Mode.

NOTES to use wireless

PROBLEM	CAUSE & CORRECTION
This device may have wireless interference.	<ul style="list-style-type: none"> • Wireless may not operate normally in weak signal area. • Please install the device close enough to wireless subwoofer. • Do not install the device on metal furniture for optimum performance.
Bluetooth device may malfunction or make noise in the following cases.	<ul style="list-style-type: none"> • When any part of your body contact the transceiver of the Bluetooth device or sound bar. • When there is an obstacle or wall or the device is installed in a secluded spot. • When there is a device (a wireless LAN, a medical equipment or a microwave) using same frequency, make the distance between the products as far away as possible each other. • When to connecting the device to the Bluetooth device, make the distance between the products as close as possible each other. • When the device gets too far from the Bluetooth device, the connection is disconnected and also malfunction may occur.

Trademarks and licenses

All other trademarks are trademarks of their respective owners.



Manufactured under license from Dolby Laboratories. Dolby, Dolby Audio, and the double-D symbol are trademarks of Dolby Laboratories.



For DTS patents, see <http://patents.dts.com>. Manufactured under license from DTS Licensing Limited. DTS, the Symbol, DTS and the Symbol together, and Digital Surround are registered trademarks and/or trademarks of DTS, Inc. in the United States and/or other countries. © DTS, Inc. All Rights Reserved.



The **Bluetooth®** word mark and logos are registered trademarks owned by the Bluetooth SIG, Inc. and any use of such marks by LG Electronics is under license. Other trademarks and trade names are those of their respective owners.

Specifications

General	
Power consumption	Refer to the main label.
	Networked standby : 0.5 W (If all network ports are activated.)
AC adapter	<ul style="list-style-type: none"> • Model : DA-38A25 • Manufacturer : Asian Power Devices Inc. • Input : 100 - 240 V ~ 50 - 60 Hz • Output : 25 V $\overline{\text{---}}$ 1.52 A
Dimensions (W x H x D)	Approx. 890.0 mm x 53.0 mm x 85.0 mm Without foot
Operating temperature	5 °C to 35 °C
Operating humidity	5 % to 90 %
Bus Power Supply (USB)	5 V $\overline{\text{---}}$ 500 mA
Available Digital Input Audio Sampling Frequency	32 kHz, 44.1 kHz, 48 kHz, 88.2 kHz, 96 kHz
Available Digital Input Audio format	Dolby Audio, DTS Digital Surround, PCM

Input	
OPTICAL IN (Digital audio in)	3 V (p-p), Optical jack x 1

Amplifier (RMS Output)	
Total	300 W RMS
Front	50 W RMS x 2 (4 Ω at 1 kHz, THD 10 %)
Subwoofer	200 W RMS (3 Ω at 80 Hz, THD 10 %)

Wireless subwoofer	
Power requirements	Refer to the main label on the wireless subwoofer.
Power consumption	Refer to the main label on the wireless subwoofer.
Type	1 Way 1 Speaker
Impedance	3 Ω
Rated Input Power	200 W RMS
Max. Input Power	400 W RMS
Dimensions (W x H x D)	Approx. 171.0 mm x 390.0 mm x 261.0 mm

- Designs and specifications are subject to change without prior notice.

Maintenance

Handling the unit

When shipping the unit

Please save the original shipping carton and packing materials. If you need to ship the unit, for maximum protection, re-pack the unit as it was originally packed at the factory.

Keeping the exterior surfaces clean

- Do not use volatile liquids such as insecticide spray near the unit.
- Wiping with strong pressure may damage the surface.
- Do not leave rubber or plastic products in contact with the unit for a long period of time.

Cleaning the unit

To clean the player, use a soft, dry cloth. If the surfaces are extremely dirty, use a soft cloth lightly moistened with a mild detergent solution. Do not use strong solvents such as alcohol, benzene, or thinner, as these might damage the surface of the unit.

