

Scan to see the online manual.



OWNER'S MANUAL

GAS COOKTOP

Read this owner's manual thoroughly before operating the appliance and keep it handy for reference at all times.

ENGLISH

UPCG3054ST UPCG3654ST



MFL69356302
Rev.04_012926

www.signaturekitchensuite.com

Copyright © 2019-2026 LG Electronics. All Rights Reserved

Safety for a Gas Cooktop

WARNING: If the information in these instructions is not followed exactly, a fire or explosion may result causing property damage, personal injury or death.

- Do not store or use gasoline or other flammable vapors and liquids in the vicinity of this or any other appliance.
- **WHAT TO DO IF YOU SMELL GAS**
 - Do not try to light any appliance.
 - Do not touch any electrical switch.
 - Do not use any phone in your building.
 - Immediately call your gas supplier from a neighbor's phone. Follow the gas supplier's instructions.
 - If you cannot reach your gas supplier, call the fire department.
- Installation and service must be performed by a qualified installer, service agency, or the gas supplier.



WARNING:

Never Operate the Top Surface Cooking Section of this Appliance Unattended.

- Failure to follow this warning statement could result in fire, explosion, or burn hazard that could cause property damage, personal injury, or death.
- If a fire should occur, keep away from the appliance and immediately call your fire department.

DO NOT ATTEMPT TO EXTINGUISH AN OIL/GREASE FIRE WITH WATER.

TABLE OF CONTENTS

4 IMPORTANT SAFETY INSTRUCTIONS

- 4 READ ALL INSTRUCTIONS BEFORE USE
- 4 WARNING STATEMENTS
- 7 CAUTION STATEMENTS

8 PRODUCT OVERVIEW

- 8 Product Features

9 OPERATION

- 9 Using the Surface Burners

12 SMART FUNCTIONS

- 12 LG ThinQ Application

15 MAINTENANCE

- 15 Care and Cleaning

19 TROUBLESHOOTING

- 19 Before Calling for Service

21 LIMITED WARRANTY

- 21 USA
- 23 CANADA

IMPORTANT SAFETY INSTRUCTIONS

READ ALL INSTRUCTIONS BEFORE USE

Safety Messages

Your safety and the safety of others are very important.

We have provided many important safety messages in this manual and on your appliance. Always read and follow all safety messages.

Download this owner's manual at <http://www.lg.com>



This is the safety alert symbol.

This symbol alerts you to potential hazards that can kill or injure you and others. All safety messages will follow the safety alert symbol and either the word WARNING or CAUTION.

These words mean:



WARNING

You may be killed or seriously injured if you do not follow instructions.



CAUTION

You may be injured or cause damage to the product if you do not follow instructions.

All safety messages will tell you what the potential hazard is, tell you how to reduce the chance of injury, and tell you what may happen if the instructions are not followed.

WARNING STATEMENTS

WARNING

- To reduce the risk of explosion, fire, death, electric shock, scalding or injury to persons when using this product, follow basic precautions, including the following:
-

Installation

- Make sure the cooktop is properly installed and grounded by a qualified installer, according to the Installation Instructions. Any adjustment and service should be performed only by qualified gas range installers or service technicians.
- Plug the cooktop into a 120-volt grounded outlet only. Do not remove the round grounding prong from the plug. If in doubt about the grounding of the home electrical system, it is your personal responsibility and obligation to have an ungrounded outlet replaced with a properly grounded, three-prong outlet in accordance with the National Electrical Code. Do not use an extension cord with this cooktop.
- To prevent fire hazard or electrical shock, do not use an adapter plug, an extension cord, or remove the grounding prong from the electrical power cord. Failure to follow this warning can cause serious injury, fire or death.
- This appliance is equipped with a three-prong grounding plug for your protection against shock hazard and should be plugged directly into a properly grounded receptacle. Do not cut or remove the grounding prong from this plug.
- Make sure all packaging materials are removed from the cooktop before operating it to prevent fire or smoke damage should the packaging material ignite.
- Make sure the cooktop is properly adjusted by a qualified service technician or installer for the type of gas (natural or LP) that is to be used. The cooktop can be converted for use with either type of gas. See the Installation Instructions.

- These adjustments must be done by a qualified service technician according to the manufacturer's instructions and all codes and requirements of the authority having jurisdiction. Failure to follow these instructions could result in serious injury or property damage. The qualified agency performing this work assumes responsibility for the conversion.
- Remove all tape and packing materials before using the cooktop. Dispose of all plastic bags after unpacking the cooktop. Never allow children to play with packing materials.
- Improper installation, adjustment, alteration, service or maintenance can cause injury or property damage. For assistance or additional information, consult a qualified installer, service agency, manufacturer (dealer) or your gas supplier.
- Never reuse old flexible connectors. The use of old flexible connectors can cause gas leaks and personal injury. Always use NEW flexible connectors when installing a gas appliance.
- This appliance must not be installed with a ventilation system that blows air downward toward the cooktop. This type of ventilation system may cause ignition and combustion problems with the gas cooking appliance resulting in personal injury or unintended operation.
- Ask the installer to show you the location of the cooktop gas shut-off valve and how to shut it off if necessary.
- Before servicing, disconnect the electrical supply.

Operation

WARNING

- NEVER use the cooktop as a space heater to heat or warm the room. Doing so may result in carbon monoxide poisoning and overheating of the cooktop.
- Gas appliances can cause minor exposure to four potentially hazardous substances, namely benzene, carbon monoxide, formaldehyde and soot, caused primarily by the improper combustion of natural or LP gas.
- Correctly adjusted burners, indicated by a blue rather than a yellow flame, will minimize improper combustion. Exposure to these substances can be minimized by opening windows or using a ventilation fan or hood.
- Do not place or use combustible materials, gasoline or other flammable vapors and liquids in the vicinity of this or any other appliance.
- Stepping, leaning or sitting on this cooktop can result in serious injuries and cause damage to the cooktop.
- Do not leave children alone or unattended where a cooktop is hot or in operation. They could be seriously burned.
- Do not allow children to climb or play around the cooktop.
- Let the burner grates and other surfaces cool before touching them or leaving them where children can reach them.
- Items of interest to children should not be stored in cabinets above a cooktop — children climbing on the cooktop to reach items could be seriously injured.
- Do not let anyone climb or stand on the cooktop. They could damage the cooktop or tip it over, causing severe personal injury.
- Never wear loose fitting or hanging garments while using the appliance. Be careful when reaching for items placed in cabinets over the cooktop. Flammable material could be ignited if brought into contact with flame or hot surfaces and may cause severe burns.
- Do not place flammable materials on or near the cooktop.
- Do not use water on grease fires. NEVER touch a flaming pan. Turn the controls off. Smother a flaming pan on a surface burner by covering the pan completely with a well-fitting lid, cookie sheet or flat tray. Use a multi-purpose dry chemical or foam-type fire extinguisher. Flaming grease outside a pan can be

6 IMPORTANT SAFETY INSTRUCTIONS

put out by covering it with baking soda or, if available, by using a multi-purpose dry chemical or foam-type fire extinguisher.

- If the top burner flame goes out, gas is still flowing to the burner until the knob is turned to the **OFF** position. Do not leave the burners **ON** unattended.
- **Use proper pan size.** Do not use pans that are unstable or easily tipped. Select cookware having flat bottoms large enough to cover burner grates. To avoid spills, make sure cookware is large enough to contain the food properly. This will save cleaning time and prevent hazardous accumulations of food. Because heavy spattering or spills left on a range can ignite, use pans with handles that can be easily grasped and remain cool.
- Never leave the surface burners unattended at high flame settings. Boilovers can cause smoking and greasy spillovers may catch on fire.
- Control the top burner flame size so it does not extend beyond the edge of the cookware. Excessive flame is hazardous.
- Use only dry pot holders—moist or damp pot holders on hot surfaces may result in burns from steam. Do not let pot holders come near open flames when lifting cookware. Do not use a towel or other bulky cloth instead of a pot holder.
- To prevent burns, ignition of flammable materials and spillage, turn cookware handles toward the side or back of the cooktop without extending over adjacent burners.
- NEVER place any items on the cooktop. The hot air from the vent may ignite flammable items and will increase pressure in closed containers, which may cause them to burst.
- Do not store or use gasoline or other flammable vapors and liquids in the vicinity of this or any other appliance.
- Storage on Appliance - Flammable materials should not be stored on the cooktop or near surface units. This includes paper, plastic and cloth items, such as cookbooks, plasticware and towels, as well as flammable liquids.
- Carefully watch foods being fried at a high flame setting.
- Always heat fat slowly, and watch as it heats.
- Use a deep fat thermometer if possible to prevent overheating fat beyond the smoking point.
- Use the least possible amount of fat for effective shallow or deep-fat frying. Filling the pan too full of fat can cause spillovers when food is added.
- **SIGNATURE KITCHEN SUITE** does not recommend using a gas cooktop for the preparation of flaming foods. If you choose to prepare flaming foods under a hood, turn the fan on.
- To prevent burns, always be sure that the controls for all burners are at the **OFF** position and all grates are cool before attempting to remove them.
- If you smell gas, turn off the gas to the cooktop and call a qualified service technician. Never use an open flame to locate a leak.
- Do not place cooking oils or other flammable materials on or near the cooktop.
- Always turn knob to the **OFF** position before removing cookware.
- Do not store explosives, such as aerosol cans, on or near the cooktop. Flammable materials may explode and result in fire or property damage.
- Do not obstruct the flow of combustion and ventilation air.
- Do not block the airflow into or out of the cooktop. It is necessary for proper combustion and ventilation.
- Always turn knobs to the **LITE** position when igniting the top burners and make sure the burners have ignited.
- If frying a combination of oils or fats, stir together before heating or as fats slowly melt.
- Liquids such as water, coffee or tea are able to be overheated beyond the boiling point without appearing to be boiling, due to surface tension of the liquid. Visible bubbling or boiling is not always present when the container is removed from the cooktop. This could result in very hot liquids suddenly boiling over when the container is disturbed or a spoon or other utensil is inserted into the liquid.

To reduce the risk of injury to persons

- Do not overheat the liquid.
- Stir the liquid both before and halfway through heating it.
- Do not use straight-sided containers with narrow necks.
- After heating, allow the container to stand on the cooktop for a short time before moving the container.
- Use extreme care when inserting a spoon or other utensil into the container after heating.

Maintenance

- Do not attempt to repair or replace any part of the cooktop unless it is specifically mentioned in this manual. All other service should be referred to a qualified technician.
- Clean the cooktop with caution. If a wet sponge or cloth is used to wipe spills on a hot cooktop, be careful to avoid steam burns.
- Leak testing of the appliance must be conducted according to the manufacturer's instructions.
- Do not lift the cooktop. Lifting the cooktop can cause damage and improper operation of the cooktop.
- If the cooktop is located near a window, do not hang long curtains that could blow over the surface burners and catch on fire.

CAUTION STATEMENTS

CAUTION

- To reduce the risk of minor or moderate injury to persons, malfunction, or damage to the product or property when using this product, follow basic precautions, including the following:

Operation

- To prevent poor air circulation, place the cooktop out of the kitchen traffic path and away from drafty locations.
- If using glass cookware, make sure it is designed for top-of-range cooking.
- If frying mixtures of oils or fats, stir to combine before heating.
- Do not use a wok on the surface burners if the wok has a round metal ring that is placed over the burner grate to support the wok. This ring acts as a heat trap, which may damage the burner grate and burner head. Also, it may cause the burner to work improperly. This may cause a carbon monoxide level above that allowed by current standards, resulting in a health hazard.
- Foods for frying should be as dry as possible. Frost or moisture on foods can cause hot fat to bubble up and over the sides of the pan.
- Never try to move a pan of hot fat, especially a deep fat fryer. Wait until the fat is cool.
- Do not place plastic items on the cooktop—they may melt if left too close to the vent.
- Keep all plastics away from the surface burners.
- To avoid burns, do not clean the cooktop surface until it has cooled.

SAVE THESE INSTRUCTIONS

PRODUCT OVERVIEW

Product Features

Parts and Features

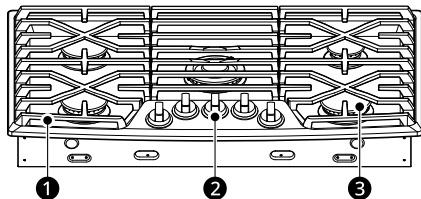

- ❶ Grate
- ❷ Burner Control Knob
- ❸ Burner

Accessories

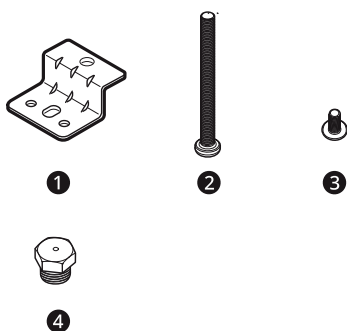

- ❶ Retainer Brackets (2 ea)
- ❷ Screws (2 ea)
- ❸ Screws (2 ea)
- ❹ Nozzles (7 ea)

NOTE

- For your safety and for extended product life, only use authorized components.
 - The manufacturer is not responsible for product malfunction or accidents caused by the use of separately purchased, unauthorized components or parts.
 - The images in this guide may be different from the actual components and accessories, which are subject to change by the manufacturer without prior notice for product improvement purposes.
-

OPERATION

Using the Surface Burners

Before Using the Surface Burners

Throughout this manual, features and appearance may vary from your model.

- Make sure all grates on the cooktop are properly placed before using any burner.
- Be sure the burners and grates are cool before you place your hand, a pot holder, cleaning cloths or other materials on them.
- Make sure all burners are in place.
- Do not operate the burner for an extended period of time without cookware on the grate. The finish on the grate may chip without cookware to absorb the heat.
- Do not use containers larger than 12" for the front burner. An oversized container can cause the knob to become hot enough to cause injury.
- Take care when handling knobs. Knobs may become hot during prolonged use of the cooktop.

Lighting a Gas Surface Burner

- Be sure all the surface burners are placed in their respective positions.
- Push the control knob in and turn it to the **LITE** position.

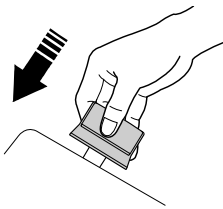

- The clicking noise you hear is the sound of the electric spark igniting the burner.
- A clicking sound may also be heard during operation due to the flame detection function.
- To control the flame size, turn the knob. If the knob stays at **LITE**, it will continue to click.
- When turning a burner to **LITE**, all the burners spark. Do not attempt to disassemble or clean around any burner while another burner is on. An electric shock may result, which could cause you to knock over hot cookware.

In Case of Power Failure

- In case of a power failure, you can light the gas surface burners on the cooktop with a match. Hold a lit match to the burner, then push in and turn the control knob to the **LITE** position. Use extreme caution when lighting burners this way.
- Surface burners in use when an electrical power failure occurs will continue to operate normally.

Sealed Gas Burners

- The cooktop has five sealed gas burners. They offer convenience, cleanability and flexibility to be used in a wide range of cooking applications.

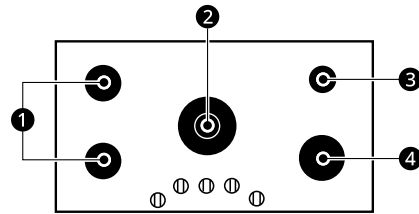

- ❶ Medium
- ❷ Extra Large (Dual)
- ❸ Small
- ❹ Large (Dual)

- The small ❸ burner offers a very low simmer setting and is best for delicate foods such as sauces that require long simmer times over low heat.
- The medium ❶ and large ❹ burners are the primary burners for most cooking. The temperature range on these burners can handle a wide range of cooking tasks.
- The extra large burner ❷ is the maximum output burner. Like the other burners, it can be used for most everyday cooking tasks. This burner is also designed to quickly bring large amounts of liquid to a boil. The special **RapidHeat** setting is designed for use with cookware 10 inches or larger in diameter. The extra large dual burner can also be used on **LO** to simmer.

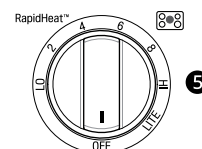

10 OPERATION

5 Extra Large Burner only

Selecting Flame Size

NEVER let the flames extend up the sides of the cookware.

Watch the flame, not the knob, while reducing the heat. When fast heating is desired, the flame size on a gas burner should match the cookware used.

Flames larger than the bottom of the cookware will not result in faster heating of the cookware and could be hazardous.

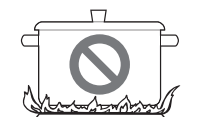

Cookware

• Aluminum

Medium-weight cookware is recommended because it heats quickly and evenly. Most of the foods brown evenly in an aluminum skillet. Use sauce pans with tight fitting lids when cooking with minimum amounts of water.

• Copper

An excellent heat conductor but discolors easily.

• Cast-Iron

If heated slowly, most skillets will give satisfactory results.

• Stainless Steel

This metal alone has poor heating properties and is usually combined with copper, aluminum or other metals for improved heat distribution. Combination metal skillets usually work satisfactorily if they are used with medium heat as the manufacturer recommends.

• Enamelware

Under some conditions, the enamel of some cookware may melt. Follow cookware manufacturer's recommendations for cooking methods.

• Glass

There are two types of glass cookware - those for oven use only and those for top of the range cooking (saucepans, coffee and teapots). Glass conducts heat very slowly.

• Heatproof Glass Ceramic

Can be used for either surface or oven cooking. It conducts heat very slowly and cools very slowly. Check cookware manufacturer's

directions to be sure it can be used on gas ranges.

Using a Wok

Do not use a wok support ring. Placing the ring over the burner or grate may cause the burner to work improperly, resulting in carbon monoxide levels above allowable standards.

This can be a health hazard.

Use a 14 inch or smaller flat bottom wok. Make sure the wok bottom sits flat on the grate.

Woks are available at a local retail store.

Only a flat-bottomed wok should be used.

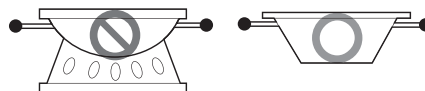

Stove-Top Grills

Do not use stove top grills on the surface burners. Using the stove top grill on the surface burner will cause incomplete combustion and can result in exposure to carbon monoxide levels above allowable current standards.

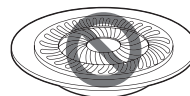

This can be a health hazard.

Using the Griddle

The enamel-coated griddle provides an extra - large cooking surface for meats, pancakes or other food usually prepared in a frying pan or skillet.

NOTE

- The griddle will discolor over time as it becomes seasoned with use.
-

How to Place the Griddle

- The griddle can only be used on the left side grate.
- The griddle must be properly placed on the grate.
- When the correct side is facing the front, the tabs on the underside of the griddle sit properly

on the prongs of the grate to keep the griddle from moving.

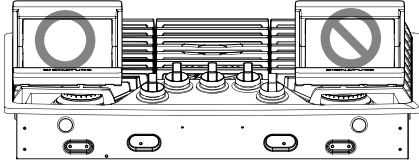

NOTE

- Do not remove the left side grate when using the griddle.

CAUTION

- Do not remove the griddle plate until the cooktop grates, surfaces and griddle plate are completely cooled.
- The griddle plate on the cooktop may become very hot when using the cooktop. Always use oven mitts when placing or removing the griddle plate.

NOTE

- Avoid cooking extremely greasy foods, as grease spills can occur.
- The griddle can become hot when surrounding burners are in use.
- Do not overheat the griddle. This can damage the enamel coating.
- Do not cut foods on the griddle.
- Do not place or store items on the griddle.
- Do not clean the griddle in the dishwasher or in a self-clean oven cycle.

How to Season the Griddle

As with cast-iron cookware, the griddle will acquire more non-stick properties with use. To shorten this process, you can season the griddle following these steps.

- 1 Apply a light, even coat of vegetable oil across the entire surface of the griddle, making sure the oil does not pool or puddle.
- 2 Place the griddle in an oven on the middle rack. Set the oven to 550 °F and bake for one hour.

- 3 Turn off the oven and allow the griddle to cool completely in the oven before removing it.
- 4 Repeat steps 1 through 3 two more times, for a total of three seasoning cycles.

How to Clean the Griddle

- Clean the griddle by hand.
 - Do not clean the griddle using a dishwasher or an oven self-clean cycle.
 - To avoid damaging the surface, do not leave the griddle to soak in water.
- 1 For normal cleaning, wipe the griddle off with a damp cloth or paper towels. A mild soap can be used, but you may have to re-season the griddle afterwards.
 - 2 To clean off burned on residue, use a nylon bristle brush or non-scratch scrubbing pad. Do not use abrasive cleaners or detergents, as they can damage the surface of the griddle.
 - 3 Rinse with warm water and dry thoroughly.
 - 4 Store in a cool, dry place.

SMART FUNCTIONS

LG ThinQ Application

This feature is only available on models with Wi-Fi.

The **LG ThinQ** application allows you to communicate with the appliance using a smartphone.

LG ThinQ Application Features

- **Monitoring**
 - This function helps you check the current status, remaining time and cook settings in one place.
- **Product Notifications**
 - Turn on the Push Alerts to receive appliance status notifications. The notifications are triggered even if the **LG ThinQ** application is not open.
- **Interworking Function**
 - The **LG ThinQ** application automatically turns on/off the vent fan when paired with the cooktop. Both products must be connected to the **LG ThinQ** application and have an interworking function.
- **Timer**
 - You can set the timer from the application.
- **Firmware Update**
 - Keep the appliance updated.

NOTE

- In the following cases, you must update the network information for each appliance in the **LG ThinQ** application under **Device Cards** → **Settings** → **Change Network**.
 - wireless router is changed
 - wireless router password is changed
 - Internet service provider is changed
- To disconnect the appliance from the **Wi-Fi** network, delete the cooktop from the list of connected products in the **LG ThinQ** application.
- The appliance is not intended to be operated by means of remote control system.
- This information is current at the time of publication. The application is subject to change for product improvement purposes without notice to users.

Installing LG ThinQ Application and Connecting an LG Appliance

Models with QR Code

Scan the QR code attached to the product using the camera or a QR code reader application on your smartphone.

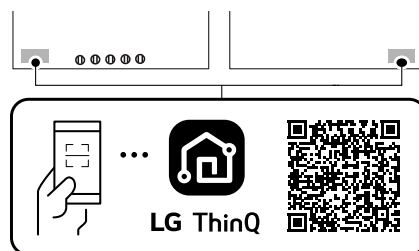

Models without QR Code

- 1 Search for and install the **LG ThinQ** application from the Google Play Store or Apple App Store on a smartphone.
- 2 Run the **LG ThinQ** application and sign in with your existing account or create an LG account to sign in.
- 3 Touch the add (+) button on the **LG ThinQ** application to connect your LG appliance. Follow the instructions in the application to complete the process.

NOTE

- To verify the Wi-Fi connection, check that the Wi-Fi icon on the control panel is lit.
- The appliance supports 2.4 GHz Wi-Fi networks only. To check your network frequency, contact your Internet service provider or refer to your wireless router manual.
- **LG ThinQ** is not responsible for any network connection problems or any faults, malfunctions, or errors caused by network connection.
- The surrounding wireless environment can make the wireless network service run slowly.
- If the distance between the appliance and the wireless router is too far, the signal becomes weak. It may take a long time to connect or fail to install the application.

- If the appliance is having trouble connecting to the Wi-Fi network, it may be too far from the router. Purchase a Wi-Fi repeater (range extender) to improve the Wi-Fi signal strength.
- The network connection may not work properly depending on the Internet service provider.
- The Wi-Fi may not connect or the connection may be interrupted because of the home network environment.
- If the appliance cannot be connected due to problems with the wireless signal transmission, unplug the appliance and wait about a minute before trying again.
- If the firewall on your wireless router is enabled, disable the firewall or add an exception to it.
- The wireless network name (SSID) should be a combination of English letters and numbers. (Do not use special characters.)
- Smartphone user interface (UI) may vary depending on the mobile operating system (OS) and the manufacturer.
- If the security protocol of the router is set to **WEP**, network setup may fail. Change the security protocol (**WPA2** is recommended), and connect the product again.
- To reconnect the appliance or add another user, press and hold the **Connect** button for 3 seconds to temporarily turn it off. Run the **LG ThinQ** application and follow the instructions in the application to connect the appliance.

installation. This equipment generates, uses, and can radiate radio frequency energy and, if not installed and used in accordance with the instructions, may cause harmful interference to radio communications. However, there is no guarantee that interference will not occur in a particular installation. If this equipment does cause harmful interference to radio or television reception, which can be determined by turning the equipment off and on, the user is encouraged to try to correct the interference by one or more of the following measures:

- Reorient or relocate the receiving antenna.
- Increase the separation between the equipment and the receiver.
- Connect the equipment into an outlet on a circuit different from that to which the receiver is connected.
- Consult the dealer or an experienced radio/TV technician for help.

This device complies with part 15 of the FCC Rules. Operation is subject to the following two conditions:

- (1) This device may not cause harmful interference and
- (2) This device must accept any interference received, including interference that may cause undesired operation.

Any changes or modifications in construction of this device which are not expressly approved by the party responsible for compliance could void the user's authority to operate the equipment.

Radio Equipment Specifications

Type	Operating Frequency Range	Output Power (Max.)
Wireless LAN	2400 MHz - 2472 MHz	< 1 W
Bluetooth [†]	2400 MHz - 2483.5 MHz	

[†] This feature is only available on some models.

FCC Notice

The following notice covers the transmitter module contained in this product.

This equipment has been tested and found to comply with the limits for a Class B digital device, pursuant to Part 15 of the FCC Rules. These limits are designed to provide reasonable protection against harmful interference in a residential

FCC RF Radiation Exposure Statement

This equipment complies with FCC radiation exposure limits set forth for an uncontrolled environment. This transmitter must not be co-located or operating in conjunction with any other antenna or transmitter.

This equipment should be installed and operated with a minimum distance of 20 cm (7.8 inches) between the antenna and your body. Users must follow the specific operating instructions for satisfying RF exposure compliance.

Industry Canada Statement

This device contains licence-exempt transmitter(s)/ receiver(s) that comply with Innovation, Science and Economic Development Canada's licence-exempt RSS(s). Operation is subject to the following two conditions:

- (1) This device may not cause interference.
- (2) This device must accept any interference, including interference that may cause undesired operation of the device.

IC Radiation Exposure Statement

This equipment complies with IC radiation exposure limits set forth for an uncontrolled environment.

This equipment should be installed and operated with a minimum distance of 20 cm (7.8 inches) between the antenna and your body.

NOTE

- THE MANUFACTURER IS NOT RESPONSIBLE FOR ANY RADIO OR TV INTERFERENCE CAUSED BY UNAUTHORIZED MODIFICATIONS TO THIS EQUIPMENT. SUCH MODIFICATIONS COULD VOID THE USER'S AUTHORITY TO OPERATE THE EQUIPMENT.
-

Open Source Software Notice Information

To obtain the source code that is contained in this product, under GPL, LGPL, MPL, and other open source licenses that have the obligation to disclose source code, and to access all referred license terms, copyright notices and other relevant documents, please visit <https://opensource.lge.com>.

SIGNATURE KITCHEN SUITE will also provide open source code to you on CD-ROM for a charge covering the cost of performing such distribution (such as the cost of media, shipping, and handling) upon email request to opensource@lge.com.

This offer is valid to anyone in receipt of this information for a period of three years after our last shipment of this product.

MAINTENANCE

Care and Cleaning

Make sure that the electrical power is off and all surfaces are cool before cleaning any part of the cooktop.

Burner Assemblies

Sealed Burner Assemblies

Turn all controls OFF before removing the burner parts.

The burner grates **1**, the burner caps **2**, and the burner heads **3** can be lifted off, making them easy to clean.

The burner electrodes **4** are not removable.

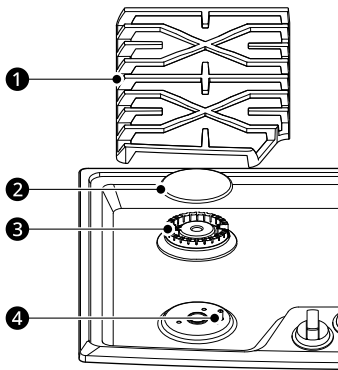

Dual Extra Large Burner Assembly

The burner head **3**, the dual burner outer cap **2** and the dual burner inner cap **1** can be lifted off, making it easy to clean.

The burner electrode **4** is not removable.

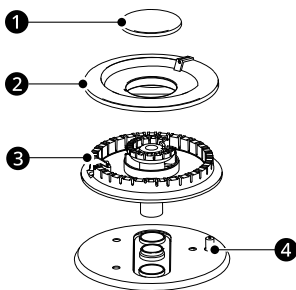

unless all burner parts and grates are properly assembled.

The electrode of the burner is exposed when the burner head and cap are removed. When one burner is turned to **LITE**, all the burners spark. Do not attempt to disassemble or clean around any burner while another burner is on. An electric shock may result, which could cause you to knock over hot cookware.

Burner Caps and Heads

Burner Caps

Lift burner caps off when they are cool.

Wash burner caps in hot, soapy water and rinse with clean water. You may scour with a plastic scouring pad to remove burned-on food particles.

	General burner
Burner cap is properly seated.	
Burner cap is NOT properly seated.	
Dual extra large burner outer cap	

To assemble the dual extra large burner outer cap properly, make sure the slit in the burner cap **1** is positioned over the assembly guide **2** in the burner head.

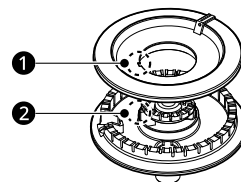

⚠ CAUTION

- DO NOT remove any parts from the cooktop until they have completely cooled and are safe to handle. Do not operate the surface burners

Burner Heads

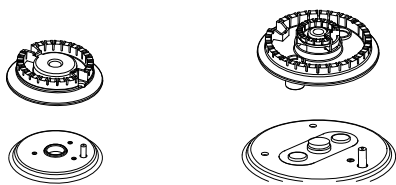

The burner heads are removable.

Simply lift them off the cooktop for cleaning.

The slits in the burner heads must be kept clean at all times for an even flame. Clogged or dirty burner ports or electrodes may cause improper operation of the cooktop.

Any spills on or around an electrode must be carefully cleaned. Take care not to hit an electrode with anything hard or it could be damaged.

Clean the burner caps and heads routinely, especially after bad spillovers which could clog the openings. Lift burner heads off when they are cool.

To get rid of burned-on food, soak the burner heads in a solution of mild liquid detergent and hot water for 20–30 minutes. For more stubborn stains, use a toothbrush.

CAUTION

- Do not hit the electrodes with anything hard. Doing so could damage them.
- Do not use steel wool or scouring powders to clean the burners.
- Do not scratch or gouge the port features of the brass burner base.
- It is normal for brass burners to become tarnished with use.

NOTE

- To clean the brass burner, use mild abrasive cleaners or liquid cleaners.
- To clean port openings, use a stiff nylon bristle toothbrush.
- Do not use steel wool or steel bristle brushes as they can scratch the brass burner surface.
- A burner will not light if the cap is removed.

After Cleaning

Before reassembling the burner caps and burner heads, shake out excess water and then dry them thoroughly.

Replacement

Replace burner heads and caps over the electrodes on the cooktop, in the correct locations according to their size. There are one small, two medium, one large and one extra large burner head and cap.

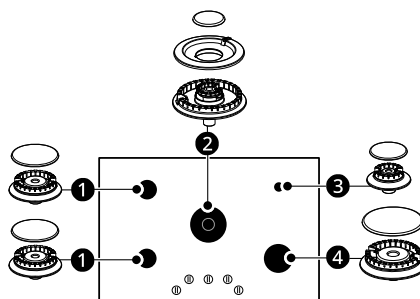

- 1 Medium Burner Head and Cap
- 2 Extra Large Burner (Center) Head and Cap
- 3 Small Burner Head and Cap
- 4 Large Burner Head and Cap

Burner Grates

The cooktop has three professional-style grates. These grates are position-specific. For maximum stability, these grates should only be used in their proper position. Because of the varied burner sizes, the side grates cannot be exchanged nor can any of the grates be rotated front to back.

Cleaning

Lift grates off when they are cool.

Grates should be cleaned regularly and, of course, after spills. Wash them in hot, soapy water and rinse with clean water. When replacing the grates, be sure they are positioned properly over the burners.

The grates may be cleaned in a dishwasher.

Do not operate a burner for a long time without cookware on the grate.

The finish on the grate may chip without cookware to absorb the heat.

To remove burned-on food, place the grates in a covered container.

Soak them with 1/4 cup ammonia for several hours or overnight. Wash, rinse well and dry.

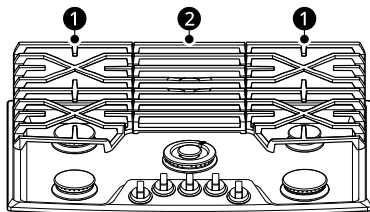

- ① Side Grate
- ② Center Grate

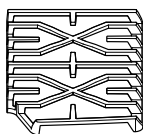

Appearance may vary. The grates may be cleaned in a dishwasher.

Although they are durable, the grates will gradually lose their shine, regardless of the best care you can give them. This is due to their continual exposure to high temperatures. You will notice this sooner with lighter colored grates.

NOTE

- Do not clean the grates in a self-cleaning oven.

Cooktop Surface

To prevent damage to the stainless steel surface of the cooktop and to prevent it from becoming dull, clean up spills immediately. Foods with a lot of acid (such as tomatoes, sauerkraut, fruit juices, etc.) or foods with high sugar content could cause a dull spot if allowed to set. When the surface has cooled, wash and rinse.

For other spills such as fat splatterings, etc., wash with soap and water after the surface has cooled. Then rinse and polish using a dry cloth.

CAUTION

- To avoid burns, do not clean the cooktop surface until it has cooled.
- Do not lift the cooktop surface. Lifting the cooktop surface can lead to damage and improper operation of the range.

NOTE

- Do not place flammable materials on or near the cooktop.

- Do not store or use combustible materials, gasoline or other flammable vapors and liquids in the vicinity of this or any other appliance.

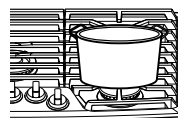

- Do not try to lift the cooktop. Lifting the cooktop can cause damage and improper operation of the cooktop.
- If water is spilled on the cooktop, wipe it up immediately. If water is left on the cooktop for a long time, it may cause discoloration of the cooktop surface and grate.
- The cooktop surface under the burner head may become discolored if the gas surface burner is used for a long time.

Stainless Steel Surfaces

Do not use a steel wool pad; it will scratch the surface.

To clean the stainless steel surface, use warm soapy water or a stainless steel cleaner or polish.

Always wipe the surface in the direction of the grain.

Follow the cleaner instructions for cleaning the stainless steel surface.

To inquire about purchasing stainless steel appliance cleaner or polish, or to find the location of the nearest dealer, call the toll-free customer service number: 1-855-790-6655 (USA), 1-888-289-2802 (CANADA) or visit our website at: <http://www.signaturekitchensuite.com>

Control Knobs

It's a good idea to wipe the control panel after each use of the cooktop.

Use mild soap and water or a 50/50 solution of vinegar and water. Use clean water for rinsing.

Clean or rinse the control panel using a damp cloth. Use mild soap and water or a 50/50 solution of vinegar and water. Use clean water for rinsing.

Do not use abrasive cleansers, strong liquid cleaners, plastic scouring pads or oven cleaners on the control knobs. They can cause damage to the finish of the knobs.

Do not try to bend knobs by pulling them up or down or by hanging a towel or other such loads. This can damage the gas valve shaft.

18 MAINTENANCE

The control knobs may be removed for easier cleaning.

Make sure the knobs are in the **OFF** position and pull them straight off the stems for cleaning.



① Surface Burner Knob

To reinstall a knob, hold it with the **OFF** label at the top and slide it directly onto the stem.

NOTE

- Unplug the cooktop before cleaning the control knobs to prevent the burners from turning on.
-

TROUBLESHOOTING

Before Calling for Service

Before calling for service, review this list. It may save you time and expense. This list includes common occurrences that are not the result of a defect in workmanship or materials.

For detailed information or videos, visit www.lg.com for the troubleshooting page.

Parts and Features

Problem	Possible Cause & Solution
Burners have yellow or yellow-tipped flames	<p>The combustion quality of burner flames needs to be determined visually.</p> <ul style="list-style-type: none"> Use the illustrations below to determine if the burner flames are normal. If burner flames look like ❶, call for service. Normal burner flames should look like ❷ or ❸, depending on the type of gas used. With LP gas, some yellow tipping on outer cones is normal. <div style="text-align: center;">  </div> <ul style="list-style-type: none"> ❶ Yellow flames: Call for service ❷ Yellow tips on outer cones: Normal for LP gas ❸ Soft blue flames: Normal for natural gas
Burner flames are very large or yellow	<p>Improper air to gas ratio.</p> <ul style="list-style-type: none"> If cooktop is connected to LP gas, contact the person who installed the range or made the conversion.
Control knobs will not turn	<p>Knob is not pushed down</p> <ul style="list-style-type: none"> To turn from OFF position, push the knob down and then turn.
Top burners do not light or do not burn evenly.	<p>Plug on cooktop is not completely inserted in the electrical outlet.</p> <ul style="list-style-type: none"> Make sure electrical plug is plugged into a live, properly grounded outlet. <p>Burner slots on the side of the burner may be clogged.</p> <ul style="list-style-type: none"> Remove the burners and clean them. Check the electrode area for burned-on food or grease. See the Care and Cleaning section. <p>Improper burner assembly.</p> <ul style="list-style-type: none"> Make sure the burner parts are installed correctly. See the Care and Cleaning section.

Wi-Fi

Problem	Possible Cause & Solution
Trouble connecting appliance and smartphone to Wi-Fi network	<p>The password for the Wi-Fi network was entered incorrectly.</p> <ul style="list-style-type: none"> Delete your home Wi-Fi network and begin the connection process again.
	<p>Mobile data for your smartphone is turned on.</p> <ul style="list-style-type: none"> Turn off the Mobile data on your smartphone before connecting the appliance.

Problem	Possible Cause & Solution
Trouble connecting appliance and smartphone to Wi-Fi network	The wireless network name (SSID) is set incorrectly. <ul style="list-style-type: none"> The wireless network name (SSID) should be a combination of English letters and numbers. (Do not use special characters.)
	The router frequency is not 2.4 GHz. <ul style="list-style-type: none"> Only a 2.4 GHz router frequency is supported. Set the wireless router to 2.4 GHz and connect the appliance to the wireless router. To check the router frequency, check with your Internet service provider or the router manufacturer.
	The appliance and the router are too far apart. <ul style="list-style-type: none"> If the appliance is too far from the router, the signal may be weak and the connection may not be configured correctly. Move the router closer to the appliance or purchase and install a Wi-Fi repeater.
	During Wi-Fi setup, the app is requesting a password to connect to the product (on certain phones). <ul style="list-style-type: none"> Locate the network name which starts with "LG" under Settings > Networks. Note the last part of the network name. <ul style="list-style-type: none"> If the network name looks like LGE_Appliance_XX-XX-XX, enter lge12345. If the network name looks like LGE_Appliance_XXXX, enter XXXX twice as your password. For example, if the network name appears as LGE_Appliance_8b92, then you would enter 8b928b92 as your password. In this instance, the password is case sensitive and the last 4 characters are unique to your appliance.
	Metal is interfering with the Wi-Fi reception. <ul style="list-style-type: none"> If the front face of the cabinet which covers the cooktop base is made of metal, the Wi-Fi may not work or the reception may be weak.

LIMITED WARRANTY

USA

TERMS AND CONDITIONS

ARBITRATION NOTICE: THIS LIMITED WARRANTY CONTAINS AN ARBITRATION PROVISION THAT REQUIRES YOU AND LG ELECTRONICS (SIGNATURE KITCHEN SUITE) TO RESOLVE DISPUTES BY BINDING ARBITRATION INSTEAD OF IN COURT, UNLESS YOU CHOOSE TO OPT OUT. IN ARBITRATION, CLASS ACTIONS AND JURY TRIALS ARE NOT PERMITTED. PLEASE SEE THE SECTION TITLED "PROCEDURE FOR RESOLVING DISPUTES" BELOW.

Should your **SIGNATURE KITCHEN SUITE** Gas Cooktop ("Product") fail due to a defect in materials or workmanship under normal and proper use, during the warranty period set forth below, **SIGNATURE KITCHEN SUITE** will, at its option, repair or replace the Product. This limited warranty is valid only to the original retail purchaser of the Product ("You") and applies only when purchased lawfully and used within the United States including U.S. Territories.

Warranty Period	Scope of Warranty	HOW SERVICE IS HANDLED
Three (3) years from the date of original retail purchase, or from the date of delivery as per applicable law	Parts and Labor (internal / functional parts only)	SIGNATURE KITCHEN SUITE will provide, free of charge, all labor and in-home service to replace defective part(s).

- Replacement Products and parts are warranted for the remaining portion of the original warranty period or ninety (90) days, whichever is greater.
- Replacement Products and parts may be new, reconditioned, refurbished, or otherwise factory remanufactured.
- Replaced Product or part(s) will be the property of **SIGNATURE KITCHEN SUITE**.
- Proof of original retail purchase specifying the Product model and date of purchase is required to obtain warranty service under this limited warranty.

EXCEPT TO THE EXTENT PROHIBITED BY APPLICABLE LAW, ANY IMPLIED WARRANTY OF MERCHANTABILITY OR FITNESS FOR A PARTICULAR PURPOSE ON THE PRODUCT IS LIMITED IN DURATION TO THE DURATION OF THE ABOVE LIMITED WARRANTY. UNDER NO CIRCUMSTANCES SHALL SIGNATURE KITCHEN SUITE OR ITS U.S. DISTRIBUTORS/DEALERS BE LIABLE FOR ANY INDIRECT, INCIDENTAL, CONSEQUENTIAL, SPECIAL, OR PUNITIVE DAMAGES, INCLUDING, WITHOUT LIMITATION, LOST GOODWILL, LOST REVENUES OR PROFITS, WORK STOPPAGE, IMPAIRMENT OF OTHER GOODS, COST OF REMOVAL AND REINSTALLATION OF THE PRODUCT, LOSS OF USE, OR ANY OTHER DAMAGES WHETHER BASED IN CONTRACT, TORT, OR OTHERWISE. SIGNATURE KITCHEN SUITE'S TOTAL LIABILITY, IF ANY, SHALL NOT EXCEED THE PURCHASE PRICE PAID BY YOU FOR THE PRODUCT.

SOME STATES DO NOT ALLOW THE EXCLUSION OR LIMITATION OF INCIDENTAL OR CONSEQUENTIAL DAMAGES OR LIMITATIONS ON HOW LONG AN IMPLIED WARRANTY LASTS, SO THE ABOVE EXCLUSIONS OR LIMITATIONS MAY NOT APPLY TO YOU. THIS LIMITED WARRANTY GIVES YOU SPECIFIC LEGAL RIGHTS AND YOU MAY ALSO HAVE OTHER RIGHTS THAT VARY FROM STATE TO STATE.

THIS LIMITED WARRANTY DOES NOT COVER:

- Service trips to deliver, pick up, or install, educate how to operate, correct wiring, or correct unauthorized repairs.
- Damage or failure of the Product to perform during power failures and interrupted or inadequate electrical service.
- Damage or failure of the Product caused by leaky or broken water pipes, frozen water pipes, restricted drain lines, inadequate or interrupted water supply or inadequate supply of air.

22 LIMITED WARRANTY

- Damage or failure of the Product resulting from operating the Product in a corrosive atmosphere or contrary to the Product owner's manual.
- Damage or failure of the Product caused by accidents, pests and vermin, lightning, wind, fire, floods, acts of nature, or any other causes beyond the control of **SIGNATURE KITCHEN SUITE**.
- Damage or failure of the Product caused by unauthorized modification or alteration, or if the Product is used for other than the intended purpose, or any water leakage where the Product was not properly installed.
- Damage or failure of the Product caused by incorrect electrical current, voltage, or plumbing codes.
- Damage or failure of the Product caused by transportation, storage, and/or handling, including scratches, dents, chips, and/or other damage to the finish of the Product, unless such damage is reported within one (1) week of delivery.
- Damage or failure of the Product resulting from misuse, abuse, improper installation, repair, or maintenance. Improper repair includes the use of parts not authorized by **SIGNATURE KITCHEN SUITE**. Improper installation or maintenance includes installation or maintenance contrary to the Product owner's manual.
- Damage or failure of the Product caused by the use of parts, components, accessories, consumable cleaning products, or any other products or services that were not authorized by **SIGNATURE KITCHEN SUITE**.
- Damage or missing items to any display or open box Product.
- Refurbished Product or any Product sold "As Is", "Where Is", "With all Faults", or similar disclaimer.
- Products with original serial numbers that have been removed, altered, or cannot be readily determined.
- Increases in utility costs and additional utility expenses.
- Any noises associated with normal operation.
- Products used for other than normal and proper household use (e.g., commercial or industrial use) or contrary to the Product owner's manual.
- Costs associated with removal and reinstallation of the Product for repairs, or the removal and reinstallation of the Product if it is installed in an inaccessible location or not installed in accordance with the Product Owner's manual.
- Accessories, removable components, or consumable parts (e.g. Shelves, door bins, drawers, water/air filters, racks, light bulbs, batteries, etc., as applicable), except for internal/functional parts covered under this limited warranty.
- Cost of conversion of the Product from natural gas to LP gas or vice versa.

The cost of repair or replacement under these excluded circumstances shall be borne by You.

TO OBTAIN WARRANTY SERVICE AND ADDITIONAL INFORMATION

Call [1-855-790-6655](tel:1-855-790-6655) and select the appropriate option from the menu.

Or visit our website at [.http://www.signaturekitchensuite.com](http://www.signaturekitchensuite.com)

Or by mail: **SIGNATURE KITCHEN SUITE** Customer Service P.O. Box 240007 Huntsville, AL 35813 ATTN: CIC

CANADA

TERMS AND CONDITIONS

ARBITRATION NOTICE: THIS LIMITED WARRANTY CONTAINS AN ARBITRATION PROVISION THAT REQUIRES YOU AND SIGNATURE KITCHEN SUITE TO RESOLVE DISPUTES BY BINDING ARBITRATION INSTEAD OF IN COURT, UNLESS THE LAWS OF YOUR PROVINCE OR TERRITORY DO NOT PERMIT THAT, OR, IN OTHER JURISDICTIONS, IF YOU CHOOSE TO OPT OUT. FOR FURTHER CLARITY, THIS ARBITRATION PROVISION IS NOT APPLICABLE TO CONSUMERS RESIDING IN ONTARIO, BRITISH COLUMBIA OR QUÉBEC. IN ARBITRATION, CLASS ACTIONS AND JURY TRIALS ARE NOT PERMITTED. PLEASE SEE THE SECTION TITLED "PROCEDURE FOR RESOLVING DISPUTES" BELOW.

QUEBEC ONLY: **SIGNATURE KITCHEN SUITE** stands behind its products and makes every reasonable effort to ensure its products can be maintained and repaired, as required. You may access the catalogue of available parts and services at https://www.lg.com/ca_en/support/. HOWEVER, **SIGNATURE KITCHEN SUITE** IN NO WAY GUARANTEES AND MAKES NO REPRESENTATIONS REGARDING THE AVAILABILITY OF ANY SPECIFIC SPARE OR REPLACEMENT PART, REPAIR SERVICE OR INFORMATION OR INSTRUCTIONS FOR SUCH MAINTENANCE AT ANY TIME. **SIGNATURE KITCHEN SUITE** EXPRESSLY DISCLAIMS ANY GUARANTEE, WARRANTY OR OBLIGATION IN RESPECT OF THAT AVAILABILITY.

Should your **SIGNATURE KITCHEN SUITE** Gas Cooktop ("Product") fail due to a defect in materials or workmanship under normal and proper use, during the warranty period set forth below, **SIGNATURE KITCHEN SUITE** will, at its option, repair, replace or pro rate the Product upon receipt of proof of the original retail purchase. This limited warranty is valid only to the original retail purchaser of the Product and applies only to a Product distributed, purchased from an authorized retailer and used within Canada, as determined at the sole discretion of **SIGNATURE KITCHEN SUITE**.

WARRANTY PERIOD: (Note: If the original date of purchase cannot be verified, the warranty will begin sixty (60) days from the date of manufacture).
--

Parts and Labor (internal/functional parts only)
--

Three (3) years from the date of original retail purchase

- Replacement products and parts are warranted for the remaining portion of the original warranty period or ninety (90) days, whichever is greater.
- Replacement products and parts may be new, reconditioned, refurbished, or otherwise factory remanufactured, all at the sole discretion of **SIGNATURE KITCHEN SUITE**.
- Proof of original retail purchase specifying the Product model and date of purchase is required to obtain warranty service under this Limited Warranty.

DISCLAIMER:

IF YOU ARE A CONSUMER SUBJECT TO QUÉBEC, BRITISH COLUMBIA OR ONTARIO'S CONSUMER PROTECTION LEGISLATION, THE EXCLUSION OF WARRANTIES CONTAINED IN THIS SECTION DO NOT EXCLUDE OR LIMIT THE RIGHTS AND REMEDIES THAT YOU MAY HAVE UNDER SUCH ACT, INCLUDING THE RIGHT TO MAKE A CLAIM UNDER ANY OF THE STATUTORY WARRANTIES PROVIDED THEREUNDER.

SIGNATURE KITCHEN SUITE'S SOLE LIABILITY IS LIMITED TO THE LIMITED WARRANTY SET OUT ABOVE, UNLESS SUCH LIMITATION IS PROHIBITED BY THE LAWS OF THE PROVINCE IN WHICH YOU RESIDE. EXCEPT AS EXPRESSLY PROVIDED ABOVE, OR IF OTHERWISE PROHIBITED BY THE LAW OF THE PROVINCE IN WHICH YOU RESIDE, **SIGNATURE KITCHEN SUITE** DOES NOT MAKE ANY OTHER WARRANTIES OR CONDITIONS RESPECTING THE PRODUCT, AND HEREBY DISCLAIMS, ALL OTHER WARRANTIES AND CONDITIONS RESPECTING THE PRODUCT, WHETHER EXPRESS OR IMPLIED, INCLUDING BUT NOT LIMITED TO, ANY IMPLIED WARRANTY OR CONDITION OF MERCHANTABILITY OR FITNESS FOR A PARTICULAR PURPOSE, AND NO REPRESENTATIONS SHALL BE BINDING ON **SIGNATURE KITCHEN SUITE**. **SIGNATURE KITCHEN SUITE** DOES NOT AUTHORIZE ANY PERSON TO CREATE OR ASSUME FOR IT ANY OTHER WARRANTY OBLIGATION OR LIABILITY IN CONNECTION WITH THE PRODUCT. TO THE EXTENT THAT ANY WARRANTY OR CONDITION IS IMPLIED BY LAW, IT IS LIMITED TO THE WARRANTY PERIOD SET OUT ABOVE. UNDER NO CIRCUMSTANCES SHALL **SIGNATURE KITCHEN SUITE**, THE MANUFACTURER OR DISTRIBUTOR OF THE PRODUCT, BE LIABLE FOR ANY INCIDENTAL, CONSEQUENTIAL, SPECIAL, DIRECT, INDIRECT, PUNITIVE OR

EXEMPLARY DAMAGES, INCLUDING, WITHOUT LIMITATION, LOSS OF GOODWILL, LOST PROFITS, LOSS OF ANTICIPATED PROFITS, LOST REVENUE, LOSS OF USE, OR ANY OTHER DAMAGE, WHETHER ARISING DIRECTLY OR INDIRECTLY FROM ANY CONTRACTUAL BREACH, FUNDAMENTAL BREACH, TORT OR OTHERWISE, OR FROM ANY ACTS OR OMISSIONS. **SIGNATURE KITCHEN SUITE'S** TOTAL LIABILITY, IF ANY, SHALL NOT EXCEED THE PURCHASE PRICE PAID BY YOU FOR THE PRODUCT.

This Limited Warranty gives you specific legal rights. You may also have other rights that vary from province to province depending on applicable provincial laws. Any term of this Limited Warranty that negates or varies any implied condition or warranty under provincial law is severable where it conflicts with such provincial law without affecting the remainder of this warranty's terms.

THIS LIMITED WARRANTY DOES NOT COVER:

- Service trips to i) deliver, pick up, or install or; educate on how to operate the Product; ii) correct wiring or plumbing; or iii) correct unauthorized repairs or installations of the Product;
- Damage or failure of the Product to perform during power failures and interrupted or inadequate electrical service;
- Damage or failure caused by leaky or broken water pipes, frozen water pipes, restricted drain lines, inadequate or interrupted water supply or inadequate supply of air;
- Damage or failure resulting from operating the Product in a corrosive atmosphere or contrary to the instructions outlined in the Product's owner's manual;
- Damage or failure to the Product caused by accidents, pests and vermin, lightning, wind, fire, floods, acts of God, or any other causes beyond the control of **SIGNATURE KITCHEN SUITE** or the manufacturer;
- Damage or failure resulting from misuse, abuse, improper installation, repair, or maintenance of the Product. Improper repair includes use of parts not authorized or specified by **SIGNATURE KITCHEN SUITE**. Improper installation or maintenance includes installation or maintenance contrary to the Product's owner's manual;
- Damage or failure caused by unauthorized modification or alteration of the Product, or if used for other than the intended household purpose/use of the Product, or damage or failure resulting from any water leakage due to improper installation of the Product;
- Damage or failure caused by incorrect electrical current, voltage or plumbing codes;
- Damage or failure caused by use that is other than normal household use, including, without limitation, commercial or industrial use, including use in commercial offices or recreational facilities, or as otherwise outlined in the Product's owner's manual;
- Damage or failure caused by the use of any accessories, components or cleaning products, including, without limitation, water filters, that are not approved/authorized by **SIGNATURE KITCHEN SUITE**;
- Damage or failure caused by transportation and handling, including scratches, dents, chips and/or other damage to the finish of the Product, unless such damage results from defects in materials or workmanship and is reported to **SIGNATURE KITCHEN SUITE** within one (1) week of delivery of the Products;
- Damage or missing items to any display, open box, refurbished or discounted Product;
- Refurbished Product or any Product sold "As Is", "Where Is", "With all Faults", or any similar disclaimer;
- Products with original serial numbers that have been removed, altered or cannot be readily determined at the discretion of **SIGNATURE KITCHEN SUITE**;
- Increases in utility costs and additional utility expenses in any way associated with the Product;
- Any noises associated with normal operation of the Product;
- Replacement of any part that was not originally included with the Product;
- Replacement of light bulbs, filters, fuses or any other consumable parts;
- Costs associated with removal and/or reinstallation of the Product for repairs; and
- Shelves, door bins, drawers, handle and accessories to the Product, except for internal/functional parts covered under this Limited Warranty.
- Conversion of products from natural gas or L.P. gas;

All costs and expenses associated with the above excluded circumstances, listed under the heading, This Limited Warranty Does Not Cover, shall be borne by the consumer.

TO OBTAIN WARRANTY SERVICE AND ADDITIONAL INFORMATION, PLEASE CALL OR VISIT OUR WEBSITE:

- Call [1-888-289-2802](tel:1-888-289-2802) and select the appropriate option from the menu.
- Visit our website at <https://www.signaturekitchensuite.com>
- By mail: 20 Norelco Drive, North York, ON, M9L 2X6

Memo

Memo



Customer Information Center

For inquiries or comments, call;

1-855-790-6655 USA, Consumer User

1-888-289-2802 CANADA, Consumer User

Centro de Información al Cliente

Para consultas o comentarios, llame por teléfono:

1-855-790-6655 EE.UU., Usuario Consumidor

1-888-289-2802 CANADÁ, Usuario Consumidor

Centre de Service à la Clientèle

Pour des questions ou des commentaires, appelez :

1-855-790-6655 ÉTATS-UNIS, Consommateur

1-888-289-2802 CANADA, Consommateur