

55EJ5G

**ENGLISH    Installation Guide**

Please read this manual carefully before operating your set and retain it for future reference.

**FRANÇAIS    Guide d'installation**

Veuillez lire ce manuel attentivement avant d'utiliser l'appareil et conservez-le pour pouvoir vous y reporter ultérieurement.

**ESPAÑOL    Guía de instalación**

Lea atentamente este manual antes de poner en marcha el equipo y consérvelo para futuras consultas.



**A-1**

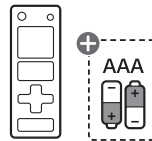

**A-2**



**A-3**



**A-4**

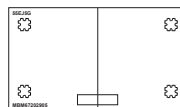

**A-5**





**A-6**



**A-7**

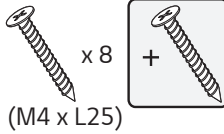

**A-8**

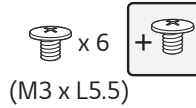

**A-9**

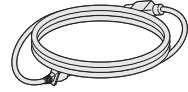

**A-10**

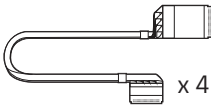

**A-11**

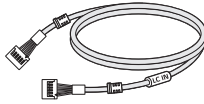

**A-12**

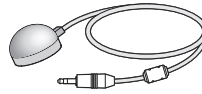

**A-13**



**A-14**

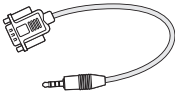

**A-15**



**A-16**

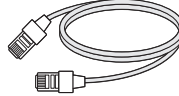

⊕ Depending upon country / Selon le pays / Según el país

**ENGLISH** Due to the environment regulations about importation and disposal of batteries, remote control batteries will not be provided with LG monitor signage / commercial TV models (Argentina and Colombia).

**ESPAÑOL** Por regulaciones de tipo ambiental respecto a la importación y destrucción de baterías, LG monitor signage / commercial TVs no van a traer incluidas las pilas del control remoto (Argentina y Colombia).

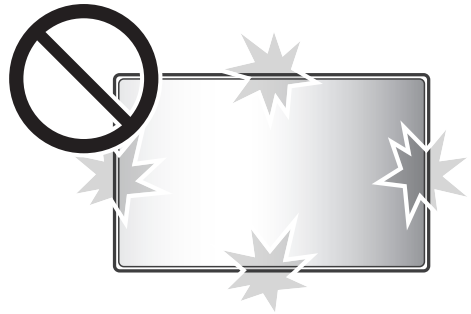
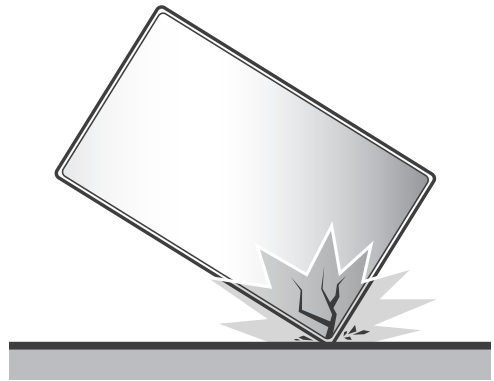
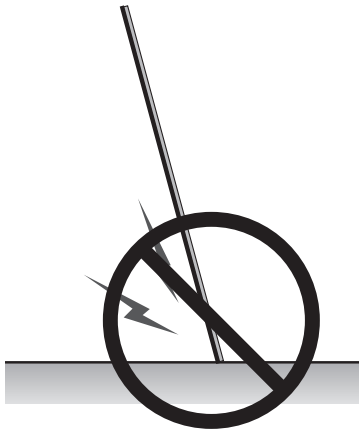

- ▶ [www.lg.com/id-manual](http://www.lg.com/id-manual)
- ▶ SuperSign : <http://partner.lge.com>

#### ENGLISH

You can download more detailed information on our website by searching the model number provided on the cover page.

#### FRANÇAIS

Vous pouvez télécharger des informations plus détaillées sur notre site Web en faisant

#### ESPAÑOL

une recherche à l'aide du numéro de modèle indiqué sur la page de couverture.  
Busque en nuestro sitio web el número de modelo que aparece en la portada y descargue información más detallada.





## ENGLISH

Dimensions (Width x Height x Depth) / Weight	Display	1220.3 mm x 696.8 mm x 4.9 mm / 6.5 kg
	Signage Box	782.8 mm x 238.4 mm x 34.7 mm / 3.4 kg

## FRANÇAIS

Dimensions (largeur x hauteur x profondeur) / Poids	Affichage	1 220,3 mm x 696,8 mm x 4,9 mm / 6,5 kg
	Boîtier d'affichage	782,8 mm x 238,4 mm x 34,7 mm / 3,4 kg

## ESPAÑOL

Dimensiones (ancho x alto x profundidad) / Peso	Pantalla	1 220,3 mm x 696,8 mm x 4,9 mm / 6,5 kg
	Decodificador	782,8 mm x 238,4 mm x 34,7 mm / 3,4 kg
Alimentación		CA 100-240 V ~ 50/60 Hz 3,7 A

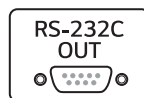
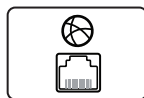
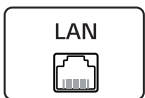
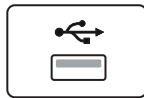
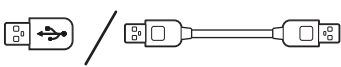
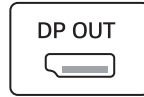
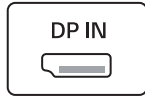



1

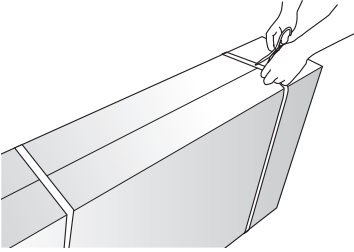

2

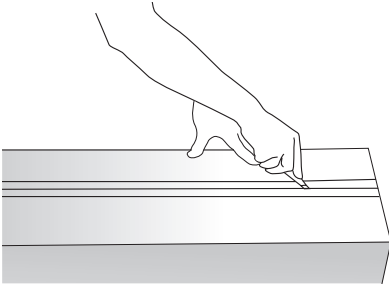

3

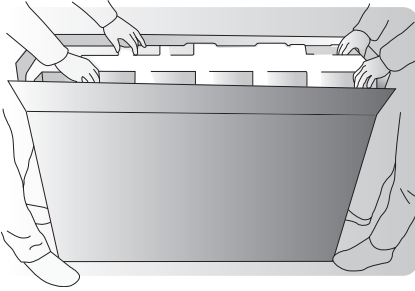

4

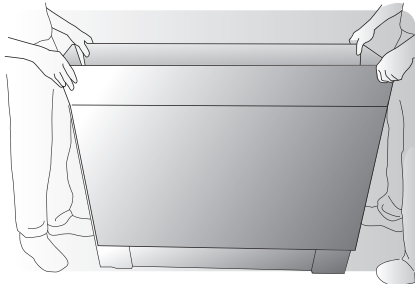

5

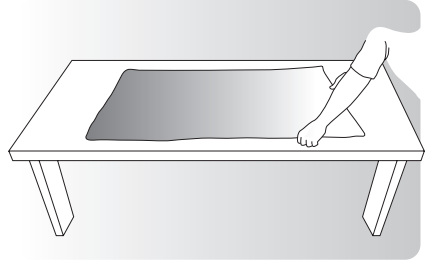

6

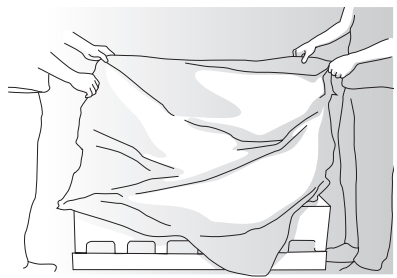

7

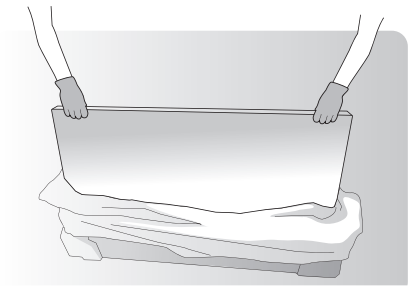

8

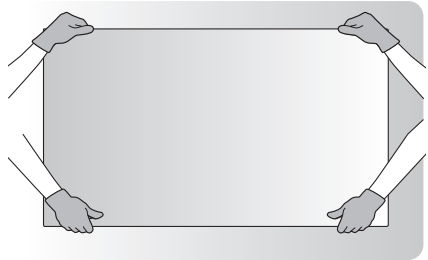

9

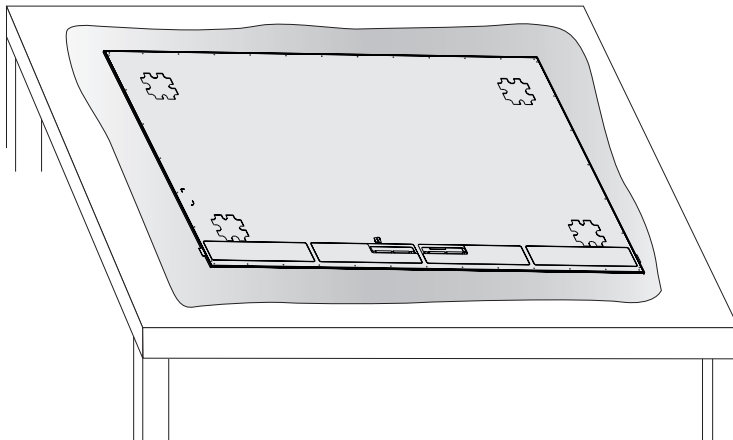

10

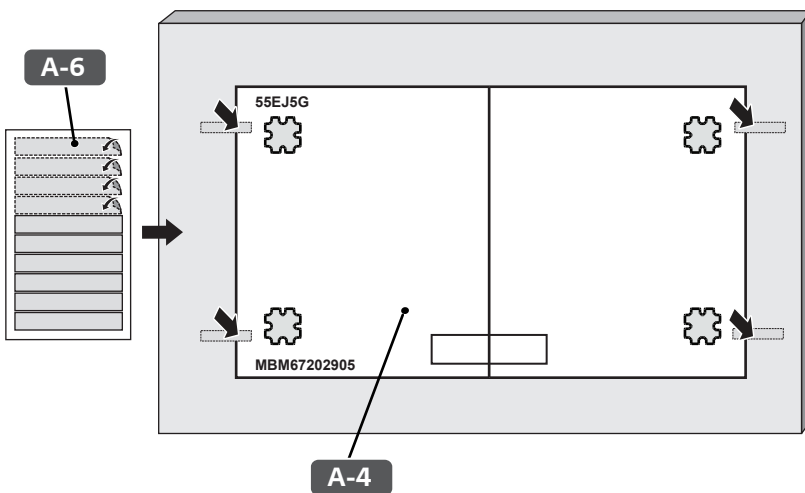

11

 : (M4 x L25)

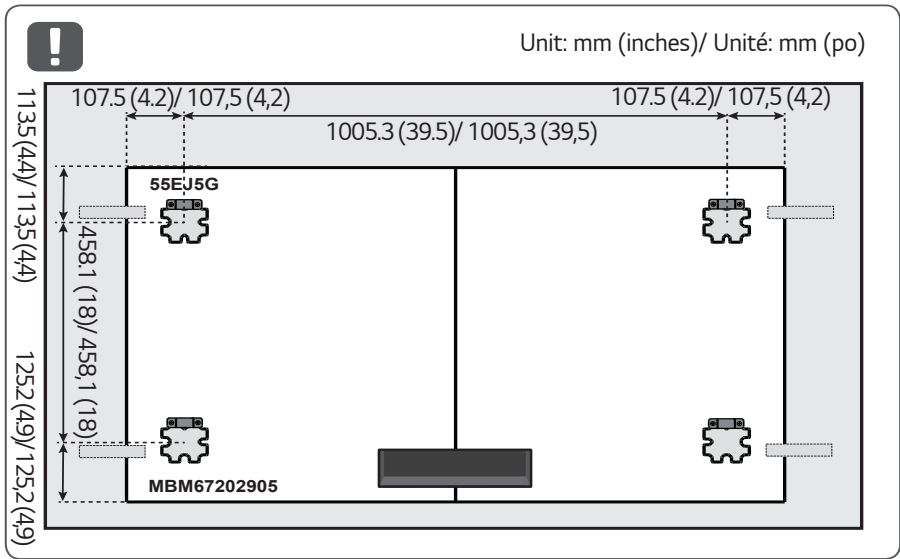
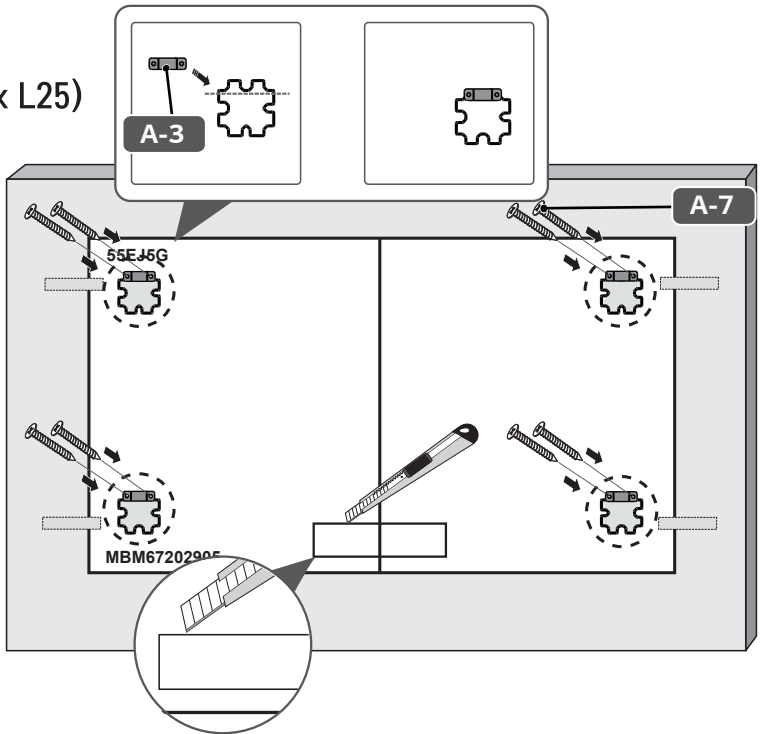

12

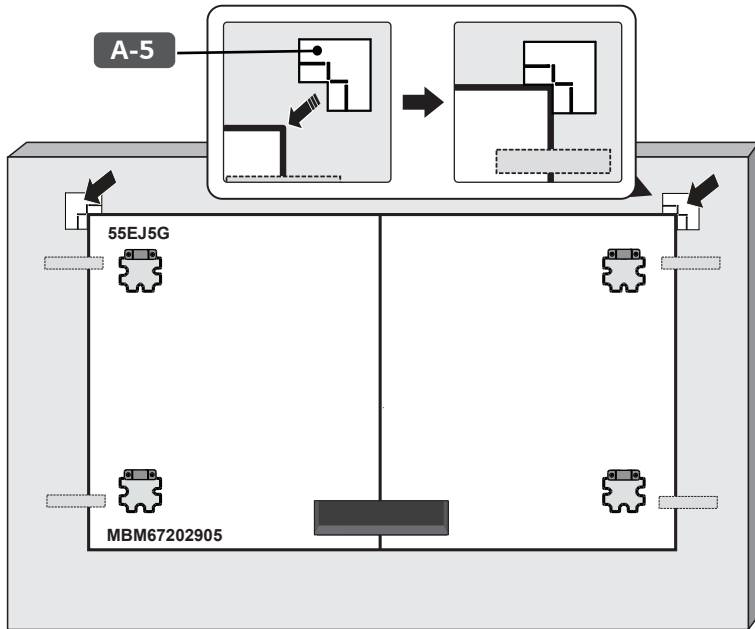

13

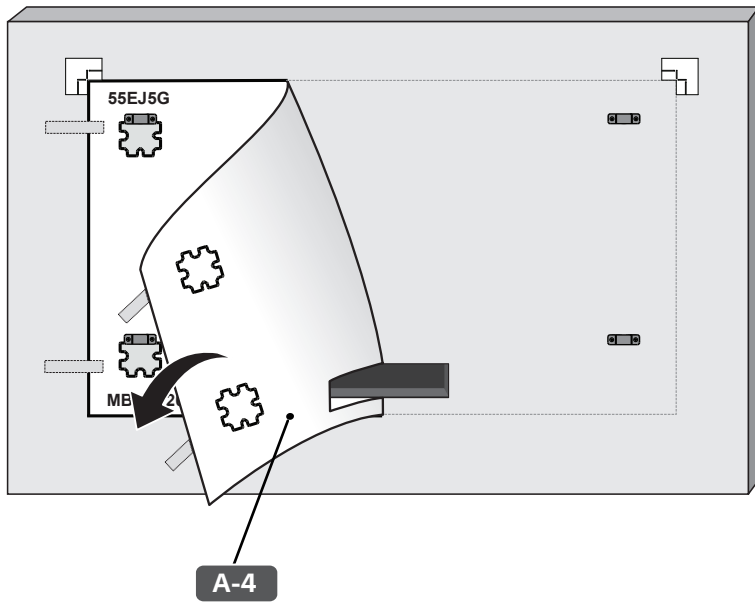

14

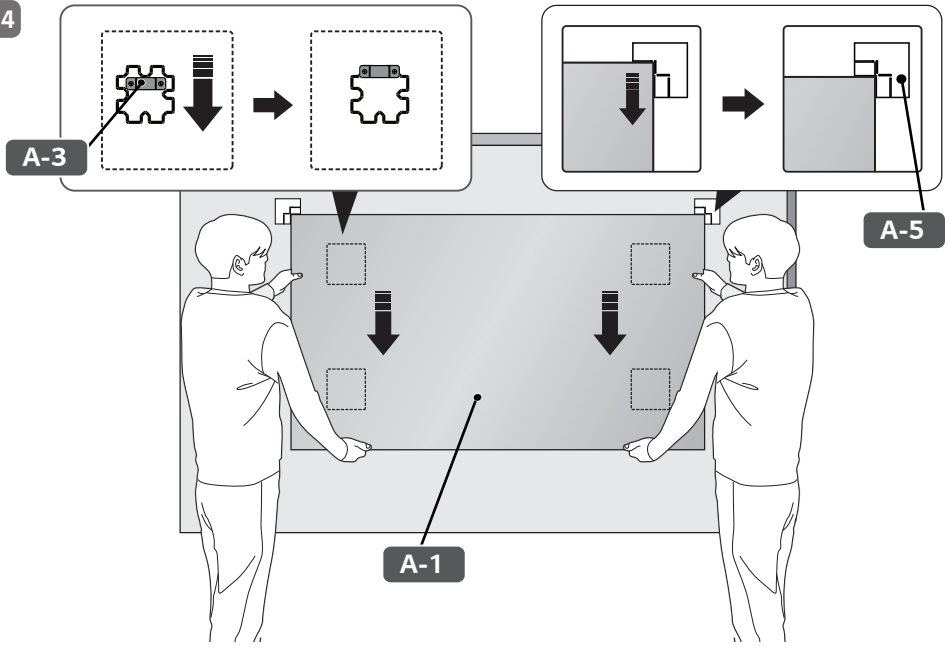

15

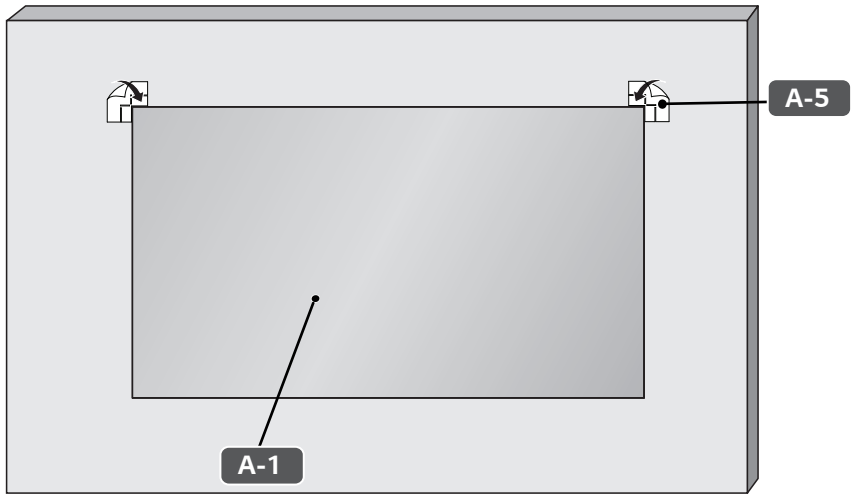

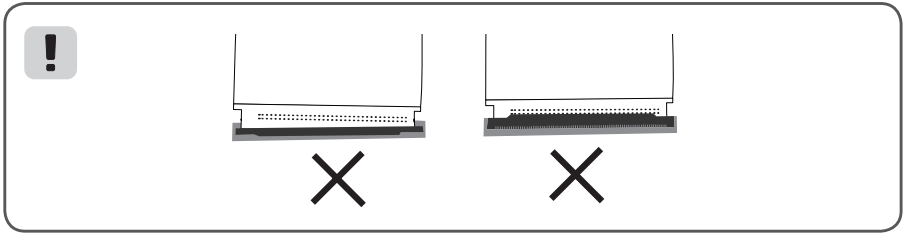
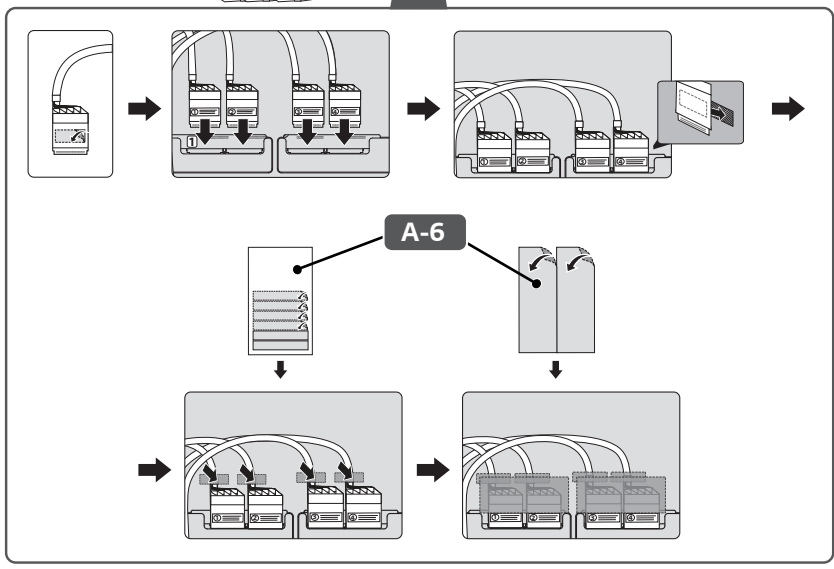
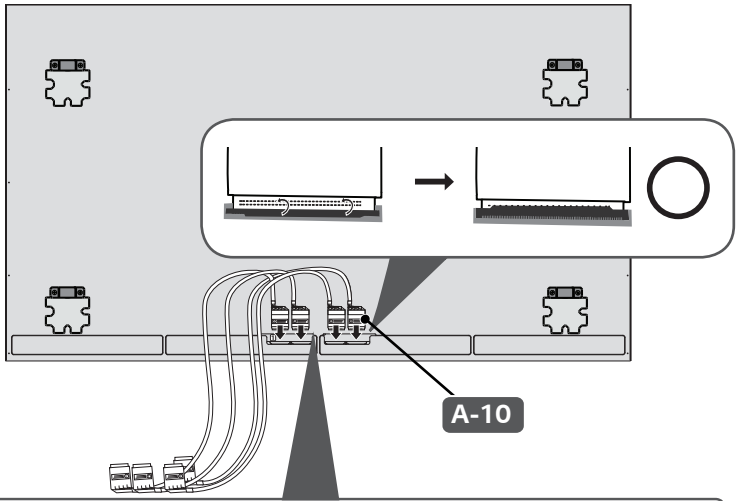

17

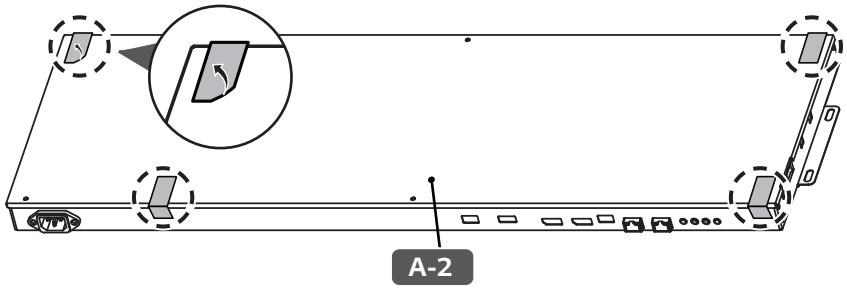

18

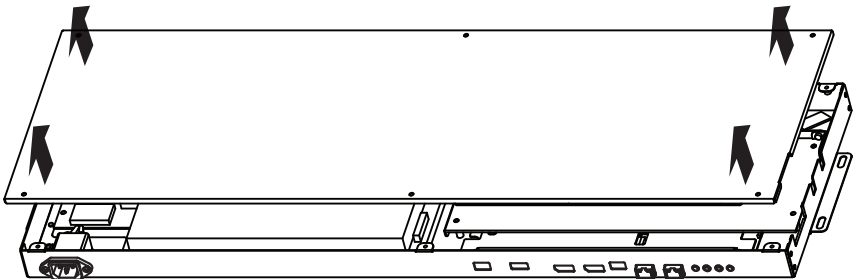

19-1

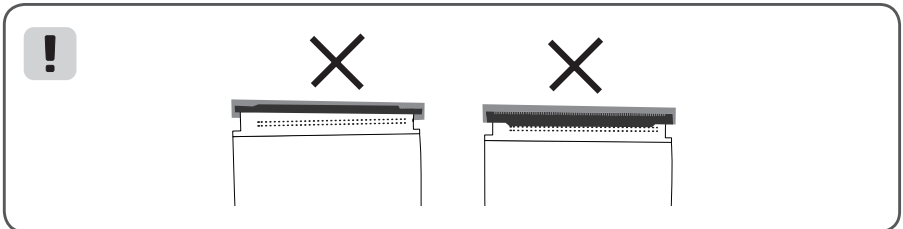
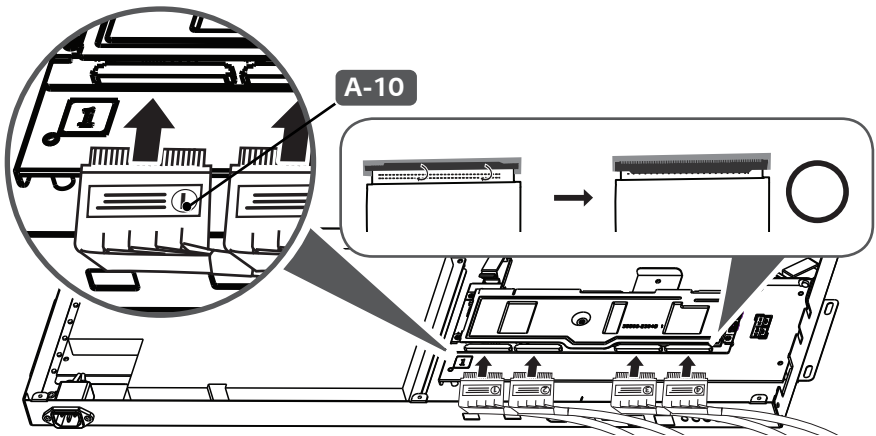

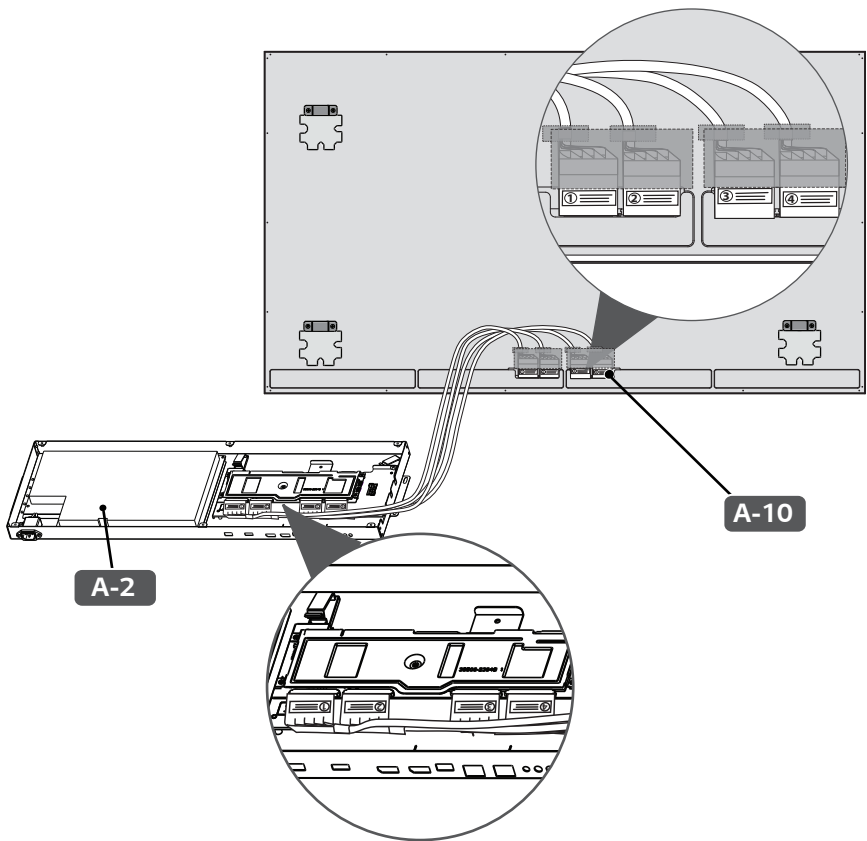

1 = 1



A-2

A-11

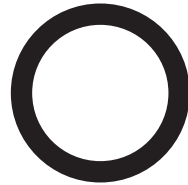
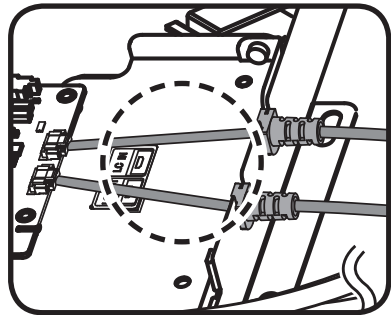
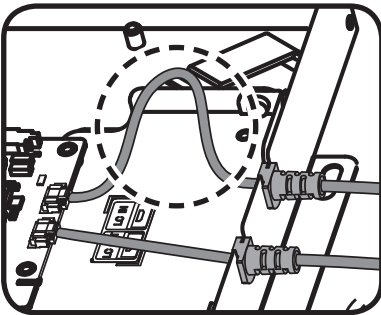
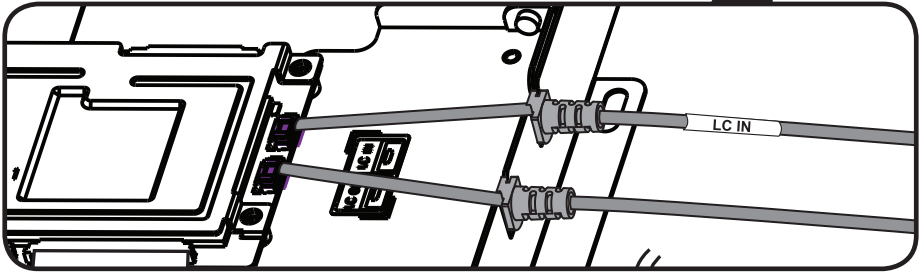
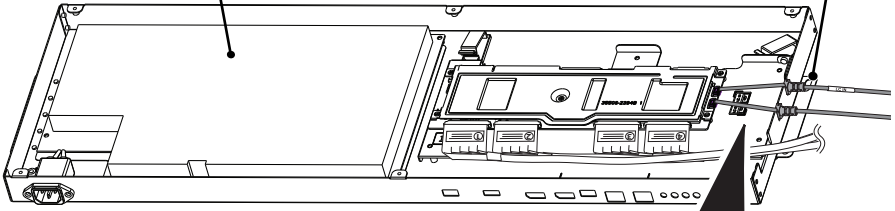

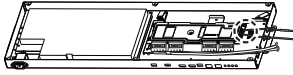

Landscape/  
Paysage/  
Horizontal

4 x 4

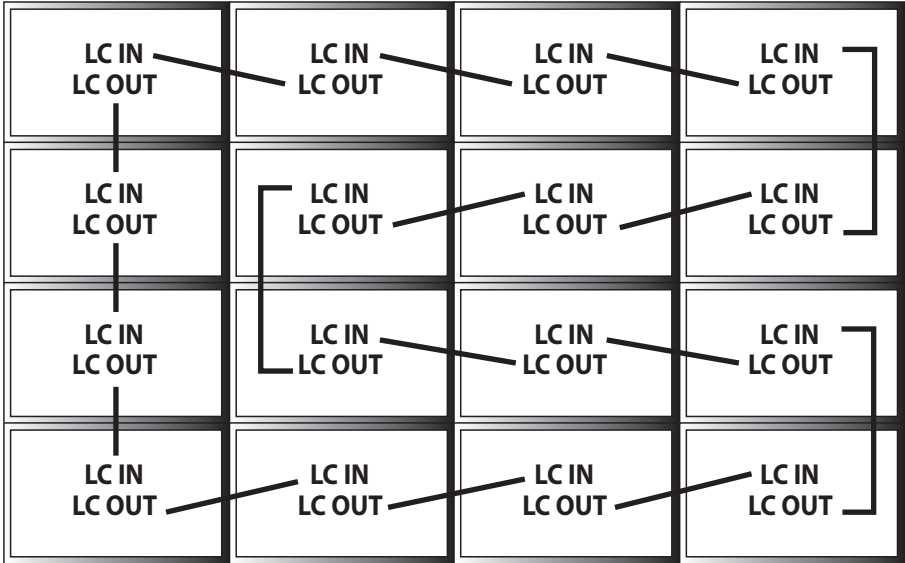

3 x 5

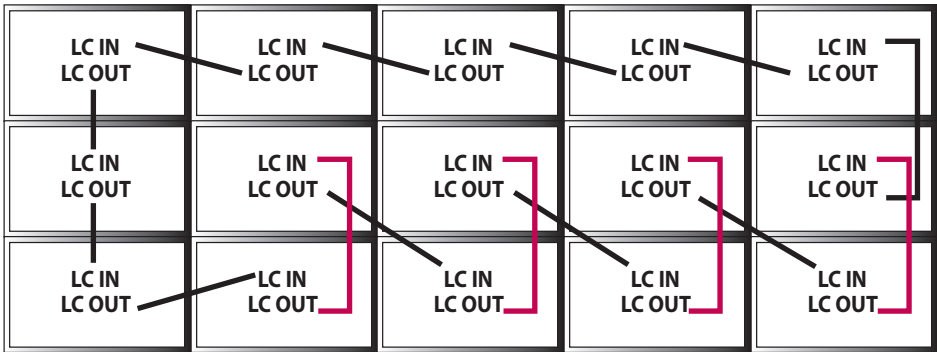

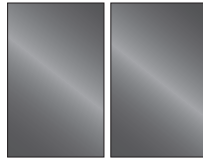
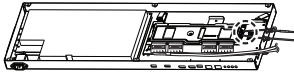

Portrait/  
Portrait/  
Vertical

4 x 4

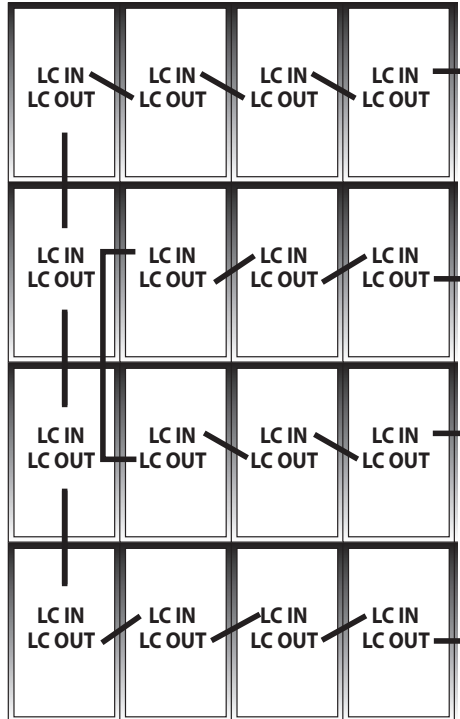

3 x 5

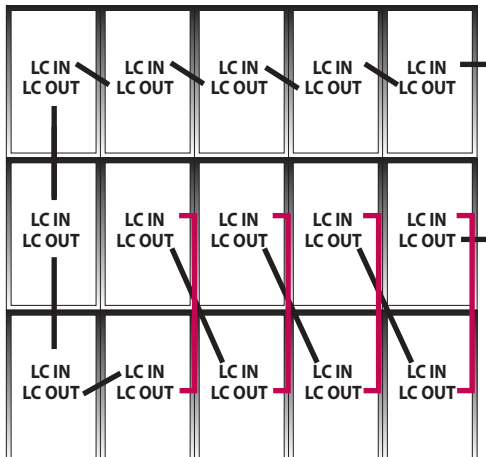

20

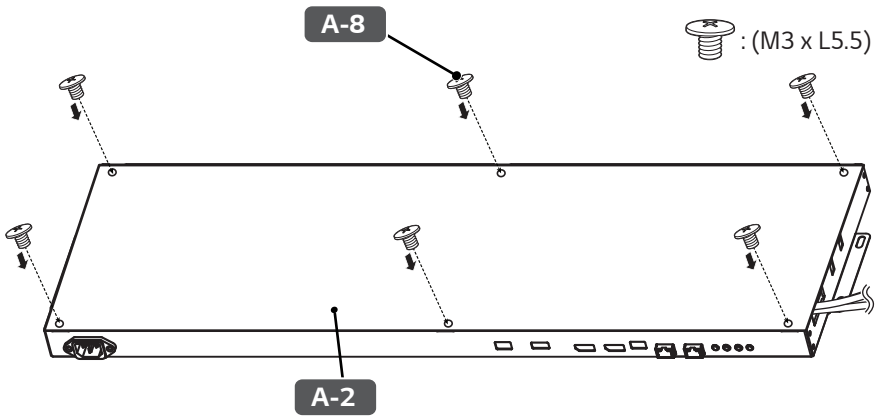

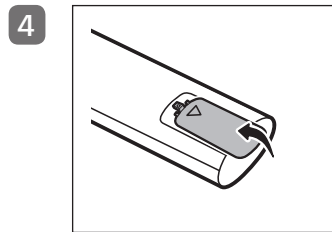
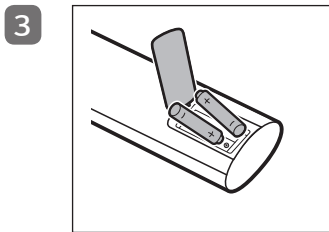
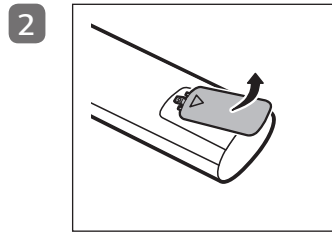
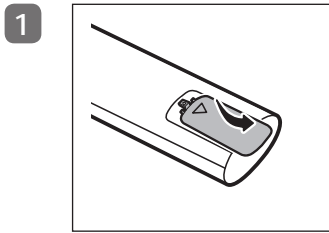
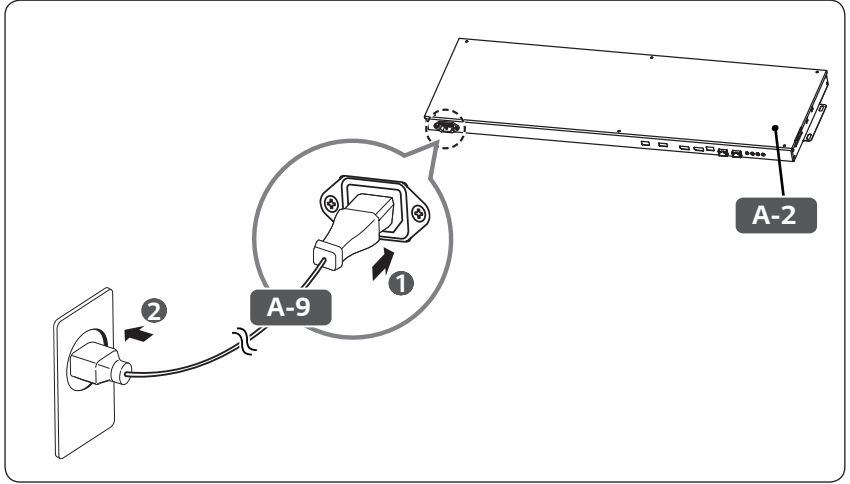

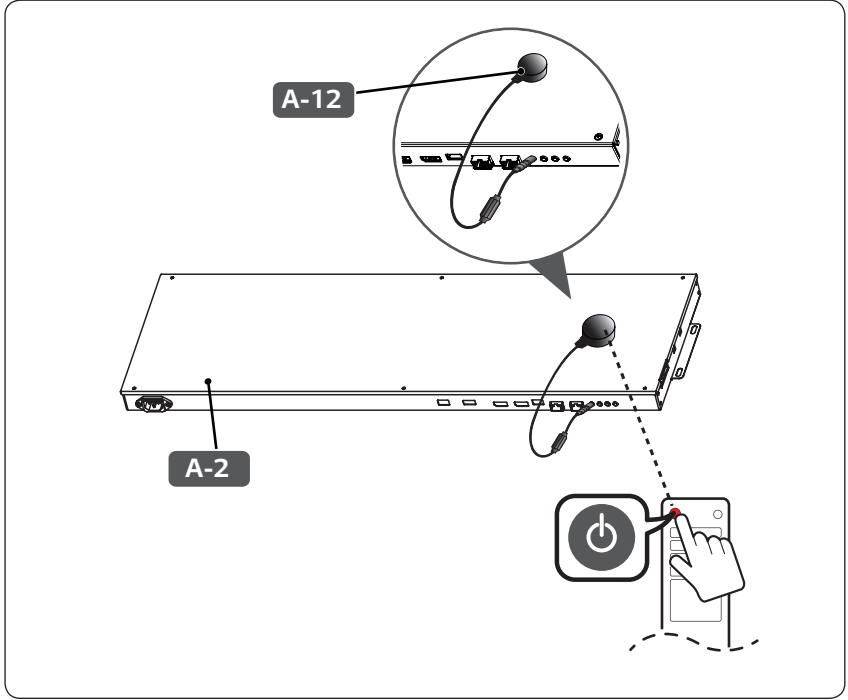









(2207-REV01)

