



OWNER'S MANUAL

LG UltraFine™ Display

OLED Pro

(Professional Video Display)

Please read this manual carefully before operating your set and retain it for future reference.

65EP5G

TABLE OF CONTENTS

SAFETY PRECAUTION	3	MENU.....	25
- Precautions for the AC Adapter and Power..	4	USER SETTINGS	33
- Precautions for Moving the Product.....	6	- Picture.....	34
- Precautions for Installing the Product.....	7	- Marker.....	41
- Precautions for Cleaning the Product	9	- Audio.....	44
- Precautions for Using the Product.....	10	- GPI.....	47
- Precautions for Using the Remote control	12	- Video Analysis.....	49
- Precautions for Experiencing Image		- Advanced Settings	52
Retention.....	12	- Calibration.....	61
- Product Disposal	12	TROUBLESHOOTING.....	63
ASSEMBLING AND PREPARING	13	PRODUCT SPECIFICATIONS... 66	
.....		LICENSES.....	73
- Optional Accessories.....	14		
- Product Installation.....	15		
- Installing on a Wall.....	16		
- Parts and Buttons	18		
REMOTE CONTROL	20		
GETTING READY	22		
MAKING CONNECTIONS.....	22		
- Connecting to a PC.....	22		
- SDI Signal Connection.....	23		
- External Device Connection.....	23		
- Using the Input List.....	24		

WARNING - This equipment is compliant with Class A of CISPR 32. In a residential environment this equipment may cause radio interference.

SAFETY PRECAUTION

The safety precautions are intended to prevent unexpected danger or harm by helping the user to use the product safely and for its intended purpose.

 **WARNING**

If you ignore the warning message, you may be seriously injured or there is a possibility of accident or death.

 **CAUTION**

If you ignore the caution message, you may be slightly injured or the product may be damaged.

 **WARNING**

This product cannot be installed outdoors. Only use the product indoors as installed by the installer.

Precautions for the AC Adapter and Power

WARNING

- Use only the power cord or AC adapter provided or approved by LG Electronics, Inc. If you use another power cord, make sure that it is certified by the national standards. If the power cable is faulty in any way, please contact the manufacturer or the nearest authorised service center for a replacement.
- Operate the display only from a power source (i.e. voltage) indicated in the product specification.
 - Otherwise the product can be damaged, fire can occur or you may be electrocuted. If you are not sure what type of power supply you have, consult a certified installation company.
- Make sure the power cord connect to a properly grounded outlet.
 - If you do not you may be electrocuted or injured or the product can be damaged.
- Insert the power plug or AC adapter firmly so it cannot come loose.
 - Poor connection may cause a fire or electric shock.
- In the presence of thunder and lightning, never touch the power cord and signal cable because it can be very dangerous.
 - It can cause electric shock.
- Be careful not to step or place heavy objects (electronic appliances, clothing, etc.) on the power cord or AC adapter. Additionally, do not bend or pull out the power cord or AC adapter with excessive force.
 - Damaged power cords may cause a fire or electric shock.
- Do not connect power cord or AC adapter damaged with sharp objects to power outlet.
 - You may be electrocuted.
- Do not insert a conductor (like a metal chopstick) into one end of the power cord while the other end is connected to the input terminal on the wall. Additionally, do not touch the power cord right after unplugged.
 - You may be electrocuted.
- Do not use with a multi-outlet connected by many electrical product and heating devices. Use an exclusive multi-outlet with a grounding terminal.
 - A fire can break out due to overheating.

- If water or any foreign substance goes inside the product, disconnect the power cord immediately and contact the service center.
 - Otherwise, this may cause a fire or electric shock due to damage to the product.
- Keep the power cord or AC adapter away from any heating devices.
 - The cord coating may melt and cause fire or electric shock.
- Never disassemble, repair or modify the power cord or AC adapter.
 - This may cause a fire or electric shock.
- Please make sure the main power cutoff device is power plug and the product is installed near the wall outlet that is easily accessible.
- As long as this unit is connected to the AC wall outlet, it is not disconnected from the AC power source even if the unit is turned off.
- Power consumption will be '0' only when the power plug is unplugged.
- Use an power plug as a disconnect device.

CAUTION

- If the outlet, pins of the power plug, or AC adapter is covered with dust, be sure wipe and keep clean.
 - Overheating due to layers of dust may cause a fire or electric shock.
- If the outlet, pins of the power plug, or AC adapter is covered with water, be sure wipe and keep clean. Additionally, Do not touch the power plug or AC adapter with wet hands.
 - This may cause an electric shock.
- Do not turn the product on or off by plugging in or unplugging the power plug from the power outlet. It means do not use the power plug as a switch.
 - This may cause an electric shock or product malfunction.
- Do not unplug the power cord while the product is in use.
 - Electrical shock can damage the product.

Precautions for Moving the Product

WARNING

- Contact the service center before moving the product.
 - It may cause electric shock and damage the product.
- Make sure the product is turned off, unplugged, and all cables have been removed before the product is moved.
 - You may be electrocuted or the product can be damaged.
- When moving the product, Do not shock the product and impact on the front panel of the product.
 - You may be electrocuted or the product can be damaged.
- Comply with the number of people according to weight of product. (Under 25 Kg (55.1 lbs) per person use lifting equipment when exceeding 100 Kg (220.4 lbs))
 - If use the damaged product again, contact the service center because it can cause electric shock or fire.
- Do not hold it upside down while holding only the stand. (It is for stand supported models only.)
 - This may cause stand warping, panel damage and other types of product damage.

CAUTION

- Do not dispose the product-packing box. It may be used put the product in the box when carrying it.

Precautions for Installing the Product

WARNING

- Contact the service center before installing the product.
 - It can cause electric shock and damage the product.
- Do not drop an object on or impact on the product. Keep out of reach of children and do not place toys or objects near the product to prevent throwing things on the product screen.
 - It can cause injury to human, problem to product and damage the display.
- Do not put heavy objects on, or hang from, the product.
 - If the product collapses or is dropped, you may be injured.
- Do not touch the surface of product to overheat.
 - It can cause injury to human.
- Install the product firmly fixed on a wall, etc. to prepare against external impact such as wind and earthquake.
 - You must refer to the manual provided.
- Do not install the product on a floor to prevent Children from climbing or hanging on the product.
 - If the product collapses or is dropped, you may be injured.
- Do not install it where there are heating devices such as electrical heaters or lighting equipment.
 - Fire, electrical shock, malfunction may occur.
- Do not install this product by yourself as you may injure yourself or cause damage to product. Please contact service engineer authorised by service center.
- Do not install this product on a wall if it could be exposed to oil or oil mist.
 - This may damage the product and cause it to fall.
- Do not leave the power or signal cable, etc. on the pathway.
 - This could cause a trip or fall, which can be caused electrical shock, fire, product breakdown, or injury.
- Do not let the product drop when connecting it to an external device connected with a short cable.
 - This may cause injury and damage to the product.
- If you drop the product or the case is broken, turn off the product and unplug the power cord and contact the service center.
 - If you continue to use without taking proper measures, electrical shock or fire can occur.
- Install the product in a dry place where it is not near dust and water. Avoid high temperatures and humidity.
 - This may cause electrical shock, fire or product damage.
- Safely install the product in a place that can hold the weight of the product.
 - A lack of strength may cause the product to fall.
- Take a comfortable and natural position to relax the muscles when working with a product.

 **CAUTION**

- Install the product where no Electromagnetic Interference occurs.
- If you install the product in a place that does not meet the recommended conditions, this may cause serious damage to the product's picture quality, life cycle, and appearance. Please check with service engineer before installing. Please do not install the product in places such as where there is an abundance of fine dust or oil mist, chemical substances are used, exposed to direct sunlight, the temperature is very high or low, the humidity is very high.
- Make sure the product is well ventilated by installing at a distance (100 mm (3.9 inches) or more) from the wall.
 - If you install the product too close to the wall, it may be deformed or fire can break out due to internal heat buildup.
- Do not cover the product with tablecloth or curtain or other material (e.g. plastic) while plugged in to block the ventilation hole of the product.
 - The product can be deformed or fire can break out due to overheating inside the product.
- Do not install the product in an area with poor ventilation (e.g. on a bookshelf, in a closet) or outside and avoid placing on cushions or carpets.
 - The product could catch fire due to overheating inside the product.
- Install the product on a flat and stable place that is large enough to support the product.
 - If the product is dropped, you may be injured or the product may be broken.
- When installing the product on a shelf or cabinet, make sure that the bottom end of the product is not protruding forward.
 - The product may fall due to unbalanced center of gravity, which may cause personal injury or damage to the product. Be sure to use cabinets or shelves that fit your product.

Precautions for Cleaning the Product

WARNING

- Keep the product clean at all times.
 - If you don't clean the unit for a long time and it becomes covered in dust, it can cause fire or product damage.
- When you need to clean the inside of the product, you must contact the service center.
 - Otherwise, cleaning without support may cause a fire, electric shock, or damage to the product.
- When cleaning the product, unplug the power cord and wipe gently with a soft cloth to prevent scratching.
 - An electric shock may occur or damage to the screen as get a scratch.
- When you want to clean the front frame, spray water onto a soft cloth 2 to 4 times and wipe in one direction only.
 - Too much moisture may cause staining.

CAUTION

- When cleaning the product or the screen, unplug the power cord and wipe it gently with a soft cloth. Do not spray water or other liquids directly on the product. Especially, do not clean your product with chemicals including glass cleaner, any type of air freshener, insecticide, lubricants, wax (car, industrial), abrasive, thinner, benzene, alcohol, etc., which can damage the product or its panel.
 - This may result in fire, electric shock or product damage (deformation, corrosion or breakage).

Precautions for Using the Product

WARNING

- Do not use the product in any environment with excessively high temperatures or humidity.
 - It may cause electrical shock or damage the product.
- If you use the product for a long period of time, take a rest from time to time to protect your vision.
 - Extended viewing could result in impaired vision.
- Listening at high volume or using for a long time can cause damage to your hearing.
- In the event that liquid or a foreign object falls into the product, please switch it off and unplug it from the wall outlet and contact the service center.
 - Otherwise, the product may cause fire or electric shock.
- In the event that no image appears on the screen or no sound is heard, stop using the product. Switch it off immediately, unplug it from the power outlet and contact the service center.
 - Otherwise, the product may cause fire or electric shock.
- Do not drop an object or impact on the product or screen.
 - It can cause injury to human, problem to product and damage the screen.
- If you can smell smoke or other odors or hear a strange sound, unplug the power cord and contact the service center.
 - If you continue to use the product without taking proper measures, it may cause electrical shock or fire.
- Do not attempt to disassemble, repair or modify the product yourself. Please contact service center if you need to repair it.
 - Fire or electric shock can occur.
- Do not place objects filled with liquids, such as vases, cups, etc. on over of the product to prevent liquid from entering the product.
 - Failure to do so may result in fire, electric shock, malfunction or deformation.
- Do not push hard on or scratch the product's surface with your hands or sharp objects, such as nails, pencils or pens. Do not shock or scratch the front and sides of the screen with metallic objects.
 - This may damage the products and cause it to malfunction.
- Do not touch the product if it has been exposed to sunlight or an intense light because it could be hot.

- Do not use high voltage electrical goods near the product (e.g., a bug zapper).
 - This may result in product malfunction if it receives an electrical shock.
- If there is a gas leak, do not touch the outlet, and open the windows for ventilation.
 - Otherwise, the product may cause fire or electric shock.
- If you drop the product or the case is broken, turn off the product and unplug the power cord.
 - If you continue to use without taking proper measures, electrical shock or fire can occur. Contact the service center.
- Keep small accessories out of the reach of children.
 - If a child swallows it, consult a doctor immediately.
- Keep out of reach of children from the product. Also, do not throw toys or objects to the product or screen.
 - It can cause injury to human, problem to product and damage the screen.
- All the power sources must be disconnected by removing the power cables to remove all power from the unit.

CAUTION

- This panel is an advanced product that contains millions of pixels. You may occasionally see pixel spots when viewing the screen. Since these deactivated pixels are not a defect, the performance and reliability of the product is not affected.
- Do not put or store inflammable substances near the product.
 - There is a danger of explosion or fire.
- Keep the proper distance from the product.
 - It can cause damage to your vision if you look at the product too closely.
- Set the appropriate resolution and frequency by products.
 - It can cause damage to your vision.
- Take a regular break when working with the product for a long time.

Precautions for Using the Remote control

WARNING

- Avoid places with high humidity.
 - It may cause electrical shock or damage the product.
- Do not expose batteries to excessive heat, such as direct sunlight, open fireplace, and electric heaters.
 - It may cause fire and you may be injured.
- Make sure that children do not swallow the remote control batteries when you replace them. Keep batteries out of reach of children.
 - If a child swallows a battery, consult a doctor immediately.
- Do not dispose of batteries in a fire.
 - Please dispose batteries at a local recycling center or a retail store that handles batteries.
- Used batteries, which include rechargeable batteries, should be recycled separately from waste.
 - Please dispose used batteries and rechargeable batteries at a local recycling center or a retail store that handles batteries.

CAUTION

- Do not short circuit and disassemble of batteries.
 - It may cause electrical shock or fire.
- The remote control may not function properly in sunlight or under a strong lamp. Move the product if it is being used in these conditions.
- Check if there is any obstacle between the product and the remote control.
- Do not mix new batteries with old batteries.
 - Overheating or leaking batteries may cause fire or electric shock.
- Only use the specified type of battery. Do not insert batteries that are not rechargeable into the charger.
 - Overheating or leaking batteries may cause fire or electric shock.

Precautions for Experiencing Image Retention

- Displaying a still image for a prolonged period of time may cause damage to the screen, resulting in image retention. Most third-party products have the same issue. The resulting damage is not covered by the product warranty.
 - Use a screen saver when using the monitor for a prolonged period of time.

Product Disposal

- Do not dispose of this product with general household waste.
- Disposal of this product must be carried out in accordance to the regulations of your local authority.

ASSEMBLING AND PREPARING

CAUTION

- Always use genuine components to ensure safety and product performance.
- The product warranty will not cover damage or injury caused by the use of counterfeit components.
- Connect the power cord to the product before you plug it into a wall outlet. Plugging the power cord into a wall outlet first may cause an electric shock, which can also damage the product.
- Do not use the product where its front / rear surfaces are exposed to direct sunlight.

NOTE

- The accessories provided with your product may vary depending on the model or region.
- Product specifications or contents in this manual may be changed without prior notice due to upgrade of product functions.
- Software & Manual
 - Downloading from the LG Electronics website.
 - Visit the LG Electronics website (<http://partner.lge.com>) and download the latest software for your model.
- The product's quality is not guaranteed for use in direct sunlight or excessive dust.

WARNING

- The product warranty does not cover any electrostatic damage to parts that may occur during product installation. Wear the appropriate gear that can prevent electrostatic discharge (ESD) when installing the product.

Optional Accessories

Without prior notice, optional accessories are subject to change to improve the performance of the product, and new accessories may be added. The illustrations in this manual may differ from the actual product and accessories.

Stand

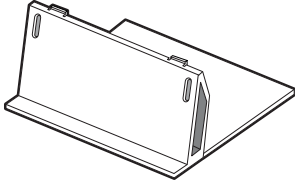

ACC-S-EP5G

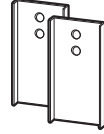

Bracket



Screws

Diameter 3.0 mm x Pitch 0.5mm x Length 4 mm
(Diameter 0.1 inches x Pitch 0.01 inches x Length 0.1 inches)

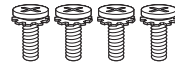

Screw

Diameter 4.0 mm x Pitch 0.7 mm x Length 14 mm
(Diameter 0.1 inches x Pitch 0.02 inches x Length 0.5 inches)

! NOTE

- Optional accessories are available for some models. If necessary, please purchase them separately.

Product Installation

Neither a separate stand nor a wall-hanging unit is provided with this product.

CAUTION

- Disconnect the power cord before moving or installing the monitor to avoid risk of electric shock.
- If you install the monitor on the ceiling, it may fall down and cause an injury. Contact a nearby agency or installation specialist.
- Do not climb or hang on the product.

NOTE

- Do not install the product in a place with no ventilation (e.g., on a bookshelf or in a closet) or on a carpet or cushion. If there is no other option but to mount the product on the wall, make sure that sufficient ventilation is provided before installation.
 - Failure to do so may result in a fire due to the increase in the internal temperature.

WARNING

- If the monitor is not positioned in a sufficiently stable location, there is a danger that it will fall. Many injuries can be avoided by taking the following simple precautions.
 - Use only fixing instruments and furniture which are able to securely support the product.
 - Ensuring the monitor is not overhanging the edge of the supporting furniture.
 - Not placing the monitor on tall furniture (for example, cupboards or bookcases) without anchoring both the furniture and the monitor to a suitable support.
 - Not placing cloth or other materials between the monitor and supporting furniture.
 - Install the product on a wall on which anchor bolts can be fixed.
 - Install the product where it can be safely supported. (On concrete, plywood, MDF, etc.)

CAUTION

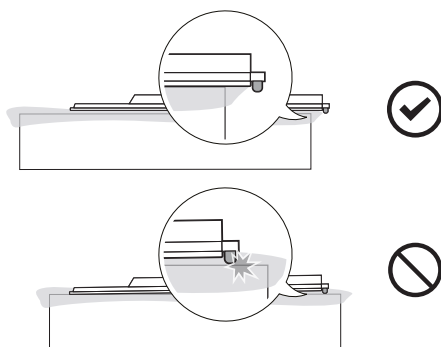

Installing on a Wall

For proper ventilation, allow a clearance of 100 mm (3.9 inches) on each side and from the wall. Detailed installation instructions are available from your dealer; see the optional Tilt Wall Mounting Bracket Installation and Setup Guide.

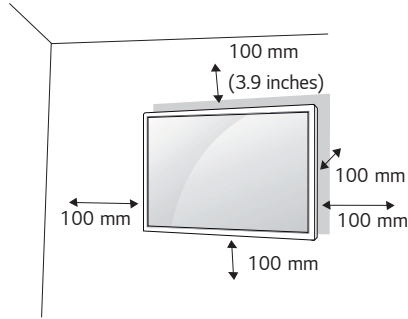

To install your monitor on a wall, attach a wall mounting bracket (optional part) to the back of the monitor. Make sure that the wall mounting bracket is securely fixed to the monitor and to the wall.

- 1 Use only screws and wall mounting brackets that conform to VESA standards.
- 2 Screws which are longer than standard length may damage the inside of the monitor.
- 3 A non-VESA standard screw may damage the product and cause the monitor to fall. LG Electronics is not liable for any accidents related to the use of non-standard screws.
- 4 Please use VESA standard as below.
 - 785 mm (30.9 inches) and above
 - * Fixing screws: Diameter 6.0 mm (0.2 inches) x Pitch 1.0 mm (0.03 inches) x Length 14 mm (0.5 inches)

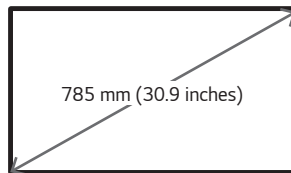

 **CAUTION**

- Disconnect the power cord before moving or installing the monitor to avoid risk of electric shock.
- If you install the monitor on a ceiling or slanted wall, it may fall and result in injury. Use an authorized LG wall mount and contact your local dealer or qualified personnel to assist with the installation.
- Do not over tighten the screws as this may damage the monitor and void your warranty.
- Use only screws and wall mounting brackets that meet the VESA standard. Any damage or injuries caused by misuse or use of improper accessories are not covered by the warranty.

 **NOTE**

- The wall mount kit includes the installation guide and all necessary parts.
- The wall mounting bracket is optional. You can obtain additional accessories from your local dealer.
- The length of screws required may differ depending on the wall mount. Be sure to use the correct length.
- For more information, please refer to the guide provided with the wall mount.

Parts and Buttons

Front

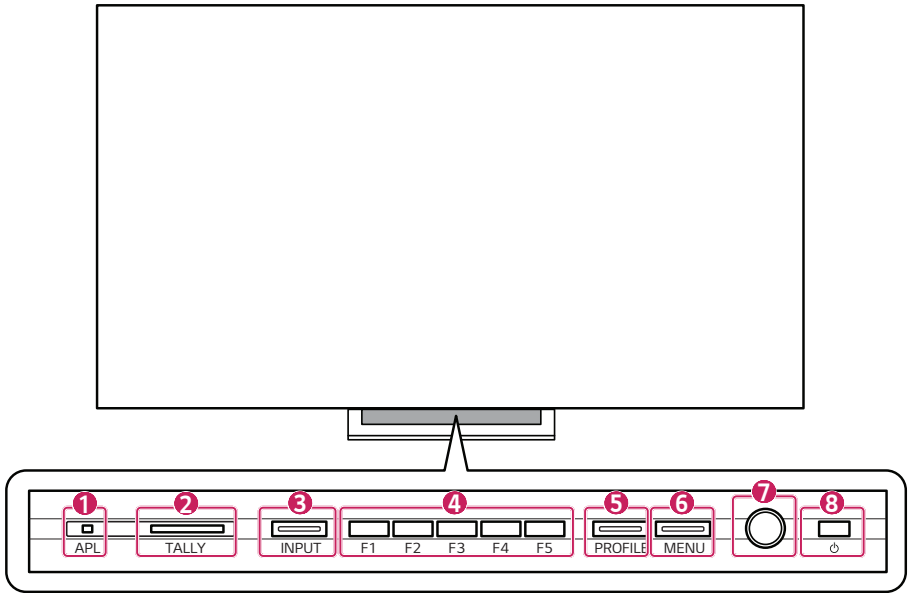

No.	Item	Explanation
1	APL	The LED flashes red when the panel brightness limit working.
2	TALLY	Supports tri-Color (red / green / orange) tally LEDs.
3	INPUT	Changes the input mode. (HDMI, SDI, SFP+, etc.)
4	F1~F5	Frequently used functions can be assigned to the buttons as shortcuts. - Once a function has been assigned to a button, pressing that button turns on the LED.
5	PROFILE	Saves or loads the monitor settings for each user.
6	MENU	Changes the menu or returns to the previous item.
7	Dial Key	The dial can be used to quickly and conveniently move up, down, left, or right. Press the dial once to select an item.
8	⏻ (Power)	Turns the power on or off.

Rear

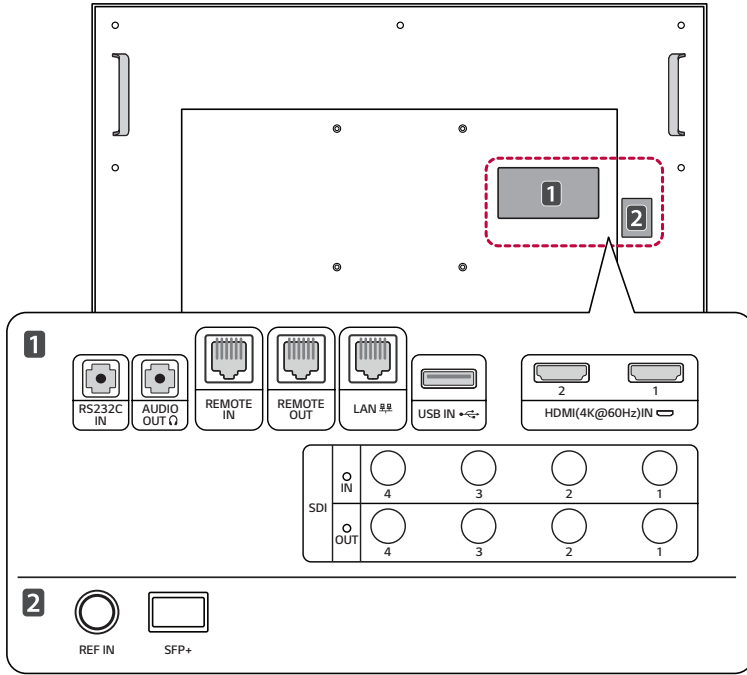

- RS232C IN: Updates and calibrate the software.
- AUDIO OUT: Outputs sound through headphones.
- REMOTE IN: Uses the GPI controller to control the monitor from the outside.

CAUTION

For safety, do not connect the connector for peripheral device wiring that might have excessive voltage to this port.

<Pin Assignment>

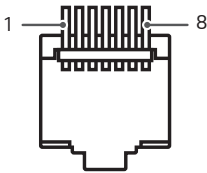

Pin	Function
1	Tally R
2	Tally G
3	Maker
4	Safety Area
5	Aspect Ratio
6	Waveform
7	Power Key
8	GND

* You can change the feature of each pin from 1 to 6 in the menu [GPI].

- REMOTE OUT (RJ45, 8pin): The input signal of the GPI controller can be used as an output.
- USB: Updates the software.
- HDMI IN: Connects HDMI signal. Please refer to the HDMI supported resolutions page. (Refer to page 72)
- SDI IN (SDI Input): Connects SDI signal. Please refer to the SDI supported resolution page. (Refer to page 68)
- SDI OUT (SDI Output): Outputs the signal entered through the SDI input terminal. (Loops through the SDI input signal.)
- REF IN: The REF IN is used for analog reference signals black burst and tri-level sync for locking.
- SFP+: This is a slot that supports SDI optical signals up to 25Gbps and SDI over IP.

REMOTE CONTROL

The descriptions in this manual are based on the buttons on the remote control. Please read this manual carefully to use the monitor correctly. To install batteries, open the battery cover, place batteries (1.5 V AAA) matching ⊕ and ⊖ terminals to the labels inside the compartment, and close the battery cover. To remove the batteries, perform the installation actions in reverse. The illustrations may differ from the actual accessories.

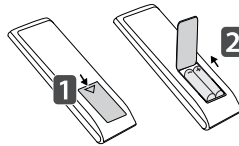

CAUTION

- Do not mix old and new batteries, as this may damage the remote control.
- Be sure to point the remote control toward the remote control sensor on the monitor.
- Some features of the remote control may not be supported in certain models.
- The product's internal and external batteries should not be exposed to excessive heat such as direct sunlight, fire, or the like.

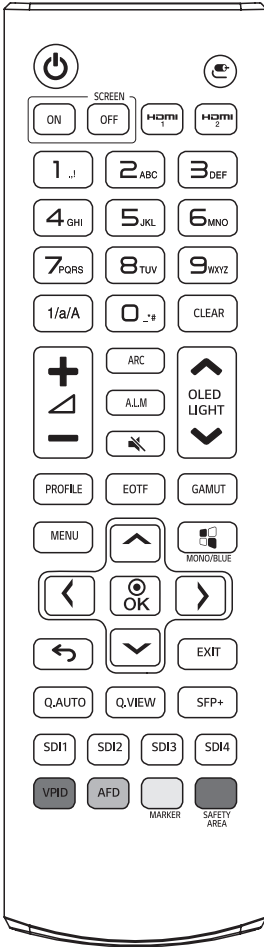

Power Turns the monitor on or off.

SCREEN ON, SCREEN OFF Turns the image on the monitor on and off.

HDMI1, HDMI2 Selects the HDMI mode.

Input Selects the input mode.

1/a/A Toggles between numerical and alphabetical. (This function is not supported.)

Number and Alphabet Button Enters numerical or alphabetical characters depending upon the setting.

CLEAR Deletes the entered numerical or alphabetical character.

+ - (Volume Control Button) Adjusts the volume of the headphone output.

ARC Selects the screen size.

A.L.M Turns the Audio Level Meter on or off.

Mute Mutes all sounds.

^ OLED LIGHT v Press the Up / Down button on the remote control to adjust the OLED brightness.

PROFILE Enters the Profile menu.

EOTF Selects EOTF (gamma).

GAMUT Selects the Color space.

MENU Enters the main menu.

MONO/BLUE Changes the Color of the image to black and white / blue.

^ v < > OK After selecting the menu, select and adjust functions.

↶ (Previous) Moves back one step in the user operation feature.

EXIT Closes the menu.

Q.AUTO Sets the Quad Link mode to Auto mode. (Automatically converts Quad Link 2SI and Square input.)

Q.VIEW Shows the signals of 4 SDI inputs in the multi-view form.

SFP+ Selects the SFP+ input mode.

SDI1, 2, 3, 4 Selects the SDI 1, 2, 3, 4 input mode.

VPID Shows the information of the SDI input signal.

AFD Turns the AFD function on or off.

MARKER Changes the Marker sequentially.

SAFETY AREA Changes the Safety Area sequentially.

GETTING READY

- It may take about one minute to initialize the product when the power is turned on for the first time after shipment from the factory.
- The images of the product in this manual are to aid comprehension and may differ from the actual appearance.
- Various accessories are subject to change or may be added without prior notice to improve the quality of the product.
- Install the product near a socket. When turning off the product, some products may not have a power on / off button, so turn off the power with the remote control and unplug the power cord.
- When connecting an HDMI cable / USB cable or USB memory stick to the HDMI input / USB input terminal, use a product with a width of 18 mm (0.7 inches) and a thickness of 10 mm (0.3 inches) or less. If the size of the USB cable or USB memory stick to be used does not match the USB port on your TV, use an extension cable that supports USB 2.0.

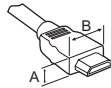

* A \leq 10 mm (0.7 inches)

* B \leq 18 mm (0.3 inches)

MAKING CONNECTIONS

You can connect various external devices to your monitor. Change the input mode and select the external device you want to connect. For more information about external device connections, see the user manual provided with each device.

Connecting to a PC

Some of the cables are not provided. This monitor supports the Plug and Play* feature.

* Plug and Play: a feature that enables a PC to recognise devices attached by the user without device configuration or user intervention when powering up.

SDI Signal Connection

- Use an SDI standard cable to secure the transmission distance of the SDI signal. (Refer to “PRODUCT SPECIFICATIONS” on page 66)
- Use in the order of SDI cable connection according to the SDI transmission specifications.
 - Single Link 12G / 6G / 3G / HD / SD-SDI and Dual-Link 3G-SDI signals can be input to the SDI IN connectors of this monitor.
 - Up to 2-channel Single Link 12G-SDI signals or 1-channel Dual-Link 3G-SDI signals can be input.
 - Use the appropriate input connectors depending on the input signal, referring to the tables below.

* Examples of SDI Signal Connection

Single Link 12G SDI		Dual Link 3G SDI	
Connector	Input Signal	Connector	Input Signal
SDI In 1	12G SDI	SDI In 1	3G SDI Link1
SDI In 2	12G SDI	SDI In 2	3G SDI Link2
Quad Link Square		Quad Link 2SI	
Connector	Input Signal	Connector	Input Signal
SDI In 1	3G SDI Link1	SDI In 1	3G SDI Link1
SDI In 2	3G SDI Link2	SDI In 2	3G SDI Link2
SDI In 3	3G SDI Link3	SDI In 3	3G SDI Link3
SDI In 4	3G SDI Link4	SDI In 4	3G SDI Link4

External Device Connection

Some of the cables are not provided. Connect a HD receiver, DVD, or VCR player to the monitor and select an appropriate input mode.

For the best picture and sound quality, connecting external devices to your monitor using HDMI cables is recommended.

! NOTE

- For the best image quality, using the monitor with HDMI connection is recommended.
- To comply with the specifications of the product, use a shielded interface cable with ferrite core, such as a HDMI cable.
- If you turn the monitor on when the set is cold, the screen may flicker. This is normal.
- Sometimes red, green, or blue spots may appear on the screen. This is normal.
- Use a High Speed HDMI®/™ cable (shorter than 3 m (9.8 feet)).
- Use a certified cable with the HDMI logo attached. If you do not use a certified HDMI cable, the screen may not display or a connection error may occur.
- Recommended HDMI Cable Types
 - High Speed HDMI®/™ Cable
 - High Speed HDMI®/™ Cable with Ethernet

- If you cannot hear any sound in HDMI mode please check your PC settings. Some PCs require you to manually change the default audio output to HDMI.
- You may experience compatibility issues if you use HDMI-PC mode.
- Make sure the power cable is disconnected.
- If you connect a gaming device to the monitor, use the cable provided with the gaming device.



CAUTION

- Do not press the screen with your finger for a prolonged period as this may result in temporary distortion on the screen.
- Avoid displaying static images on the screen for a long period of time to prevent image retention. Use a screensaver if possible.
- A wireless communication device near your monitor can affect the image.

Using the Input List





- HDMI1, HDMI2, SDI1, SDI2, SDI3, SDI4, Dual Link (SDI 1&2), Dual Link (SDI 3&4), Quad Link : Auto, Quad Link : 2SI, Quad-Link : Square, SDI Quad View, SFP+

MENU

Menu	Item 1	Item 2		Value		
Picture	Color Adjustment	OLED Light		0 ~ 100		
		Brightness		0 ~ 100		
		Contrast		0 ~ 100		
		Chroma		0 ~ 100		
		Sharpness		0 ~ 50		
		Tint		-50 ~ 50		
		White Balance Control	Method	Color Temp		VAR Temp, 9300K, 5400K, 3200K, D65 (6504K), D-Cinema (6302K)
				VAR Temp		3200K ~ 9300K
				2 Points	R-Gain (768)	-768 ~ 255
					G-Gain (768)	-768 ~ 255
					B-Gain (768)	-768 ~ 255
					R-Offset (512)	-512 ~ 511
					G-Offset (512)	-512 ~ 511
					B-Offset (512)	-512 ~ 511
				10 Points IRE	Signal Level(%)	10, 20, 30, 40, 50, 60, 70, 80, 90, 100
					Target Luminance	50 ~ 500
					Adjusting Luminance	-50 ~ 50
					Red	-50 ~ 50
					Green	-50 ~ 50
					Blue	-50 ~ 50
				22 Points IRE	Signal Level(%)	2.5, 5, 7.5, 10, 15, 20, 25, 30, 35, 40, 45, 50, 60, 65, 70, 75, 80, 85, 90, 95, 100
Target Luminance	50 ~ 500					
Adjusting Luminance	-50 ~ 50					
Red	-50 ~ 50					
Green	-50 ~ 50					
Blue	-50 ~ 50					
Reset						

Menu	Item 1	Item 2	Item 3	Value
Picture	Display Configuration	SDR / HDR Signal Format		Auto , SDR , HDR
		SDR Configuration	SDR Gamut	Auto , Native, BT.709 , BT.2020 , sRGB , AdobeRGB , P3
			SDR EOTF	Auto , User , 1.9 , 2.2 , 2.4 , 2.6
			SDR EOTF User	0.8 ~ 3.0 (0.1 step)
		HDR Configuration	HDR Gamut	Auto , Native, BT.709 , BT.2020 , sRGB , AdobeRGB , P3
			HDR 1D LUT	Factory Default
			HDR Format	Auto , BT.2100 HLG , ST 2084 PQ
			ST 2084 Tone Curve	Factory Default
			BT.2100 HLG System Gamma	Factory Default , User
			BT.2100 HLG System Gamma User	1.00 ~ 1.60
			HDR Peak Brightness	normal, high
		Dolby Vision Configuration	Dolby Vision 1D LUT	Factory Default
			Dolby Vision Parameters	Factory Default
		Transfer Matrix		Auto , BT.709 , BT.601 , BT.2020
		PQ Clip Point		Panel Peak, 700, 1000, 2000, 3000, 4000, 10000
		SDI Color Format		Auto , RGB444, YCbCr444 , YCbCr422
		Input Range		Auto , Narrow , Full , SID Full
Mono / Blue Only		Off , Mono Color , Blue Color		

Menu	Item 1	Item 2	Value	
Picture	Over Scan		Zero Scan, Over Scan, Under Scan	
	Aspect Ratio	Aspect Ratio	Full Wide, 4 : 3, 14 : 9, 13 : 9, 1.85 : 1, 2.35 : 1, 1 : 1, Original, Auto	
	Zoom	2 x Zoom		Apply
		3 x Zoom		Apply
		4 x Zoom		Apply
		5 x Zoom		Apply
	Picture Option	Noise Reduction		Off, Low, Medium, High, Auto
		MPEG Noise Reductionn		Off, Low, Medium, High, Auto
		Real Cinema		Enable/Disable
		Motion Eye Care		Enable/Disable
		Dynamic Tone Mapping		Enable/Disable
		Dynamic Contrast		Off, Low, Medium, High
		Dynamic Color		Off, Low, Medium, High
		Smooth Gradation		Off, Low, Medium, High
OLED Motion Pro			Enable/Disable	
Low Luminance Gradation		Enable/Disable		
Uniformity Compensation		Enable/Disable, Reset		
Marker	Marker		Off, 16 : 9, 4 : 3, 14 : 9, 13 : 9, 1.85 : 1, 2.35 : 1, User Marker 1, User Marker 2, User Marker 3	
	User Marker Settings	User Marker 1		
		Width		0 ~ 3840 (1920)
		Height		0 ~ 2160 (1080)
		User Marker 2		
		Width		0 ~ 3840 (1920)
		Height		0 ~ 2160 (1080)
		User Marker 3		
	Width		0 ~ 3840 (1920)	
	Height		0 ~ 2160 (1080)	
	Safety Area		Off 16 : 9, 95%/ 16 : 9, 93%/ 16 : 9, 90%/ 16 : 9, 88%/ 16 : 9, 85%/ 16 : 9, 80% 4 : 3, 95%/ 4 : 3, 93%/ 4 : 3, 90%/ 4 : 3, 88%/ 4 : 3, 85%/ 4 : 3, 80%	
Center Marker		Off,   		
Marker Thickness		1 ~ 10		

Menu	Item 1	Item 2	Value	
Marker	Marker Color	Marker		
		Line Color	White, Yellow, Blue, Red, Black	
		BG Color	None, Gray, White, Blue, Black	
		BG Transparency	0%, 20%, 40%, 60%, 80%, 100%	
		Center Marker Color	White, Yellow, Blue, Red, Black	
		Safety Area		
		Line Color	White, Yellow, Blue, Red, Black	
		BG Color	None, Gray, White, Blue, Black	
	BG Transparency	0%, 20%, 40%, 60%, 80%, 100%		
	Preset	Marker Preset 1		
		Marker Area	Off, 16 : 9, 4 : 3, 14 : 9, 13 : 9, 1.85 : 1, 2.35 : 1, User Marker 1, User Marker 2, User Marker 3	
		Safety Area	Off 16 : 9, 95%/ 16 : 9, 93%/ 16 : 9, 90%/ 16 : 9, 88%/ 16 : 9, 85%/ 16 : 9, 80% 4 : 3, 95%/ 4 : 3, 93%/ 4 : 3, 90%/ 4 : 3, 88%/ 4 : 3, 85%/ 4 : 3, 80%	
		Center Marker	Off, <input type="checkbox"/> , <input type="checkbox"/> , <input type="checkbox"/>	
		Marker Preset 2		
		Marker Area	Off, 16 : 9, 4 : 3, 14 : 9, 13 : 9, 1.85 : 1, 2.35 : 1, User Marker 1, User Marker 2, User Marker 3	
		Safety Area	Off 16 : 9, 95%/ 16 : 9, 93%/ 16 : 9, 90%/ 16 : 9, 88%/ 16 : 9, 85%/ 16 : 9, 80% 4 : 3, 95%/ 4 : 3, 93%/ 4 : 3, 90%/ 4 : 3, 88%/ 4 : 3, 85%/ 4 : 3, 80%	
		Center Marker	Off, <input type="checkbox"/> , <input type="checkbox"/> , <input type="checkbox"/>	
	Audio	Audio Source Selection		SDI1, SDI2, SDI3, SDI4, SFP+
Audio Channel Settings		Left Channel	Off, CH1 ~ 16	
		Right Channel	Off, CH1 ~ 16	
Audio Level Meter		Audio Level Meter		Enable/Disable
		Audio Display Type		Horizontal, Vertical
		Audio Channel Selection		Full, Group1, Group2, Group3, Group4, User Group
		Audio Level Meter Position		Top, Middle, Bottom
		Audio Level Meter Size		Small, Large

Menu	Item 1	Item 2	Value
GPI	GPI Control		Enable/Disable
	GPI 1		Undefined, Marker Preset 1, Marker Preset 2,
	GPI 2		Marker, Center Marker, Safety Area, Tally R, Rally G,
	GPI 3		Input HDMI1, Input HDMI2, Input SDI1, Input SDI2,
	GPI 4		Input SDI3, Input SDI4,
	GPI 5		Input Dual Link (SDI 1&2), Input Dual Link (SDI 3&4),
	GPI 6		Input Quad Link: Auto, Input Quad Link: 2SI, Input Quad Link: Square, Input SDI Quad View, Input SFP+, Scan, Aspect Ratio, Menu Key, Enter Key, Up Key, Down Key, Function Key 1, Function Key 2, Function Key 3, Function Key 4, Function Key 5, Waveform
	GPI 7		Power Key
Video Analysis	Waveform	Waveform	Off, WF, VT, WF+VT
		Vector Color	Enable/Disable
		Position	Left-Top, Right-Top, Left-Bottom, Right-Bottom
		Size	Small, Large
	Transparency	Off, 25%, 50%, 75%	
	HDR / SDR Monitoring		Off, 1 Source Mode, 2 Source Mode
Input Source		HDMI 1, HDMI 2, SDI 1, SDI 2, SDI 3, SDI 4, SFP+	

Menu	Item 1	Item 2	Value
Advanced	Profile	Load Profile	Profile1 ~ 10
		Save as Profile	Profile1 ~ 10
		Reset Profile	Profile1 ~ 10
		Change Profile Password	
		Option for Loading Saved Profiles	Load without Entering Password
	Function Key	F1	Undefined, Marker, Safety Area, Marker Preset 1, Marker Preset 2, Aspect Ratio, Audio Level Meter, Mono / Blue Only, Waveform, Vector Color, Time Code, EOTF, Interlacing / De-interlacing Mode, Gamut
		F2	
		F3	
		F4	
		F5	
	On Screen Display	Menu Option	
		Menu Language	English, Korean
		Menu Position	Center, Left-Top, Right-Top, Left-Bottom, Right-Bottom
		Menu Transparency	0 %, 10 %, 20 %, 30 %, 40 %, 50 %, 60 %, 70 %, 80 %, 90 %, 100 %
		Time Code	Time Code : Off / LTC / VITC Time Code Size : Small / Large Time Code Position : Left-Top / Center-Top / Right-Top / Left-Bottom / Center-Bottom / Right-Bottom Time Code Transparency : 0% / 25% / 50% / 100% VITC Line : Auto / Line 1~31
		UMD	
		UMD	Enable/Disable
		UMD Character	
		UMD Position	Left-Top, Center-Top, Right-Top, Left-Bottom, Center-Bottom, Right-Bottom
		UMD FG Color	Transparent,
		UMD BG Color	RGB (0,0,0), RGB (255,0,0), RGB (0,255,0), RGB (0,0,255), RGB (255,255,0), RGB (255,0,255), RGB (0,255,255), RGB (255,255,255), RGB (192,0,0), RGB (0,192,0), RGB (0,0,192), RGB (192,192,0), RGB (192,0,192), RGB (0,192,192), RGB (192,192,192), RGB (128,0,0), RGB (0,128,0), RGB (0,0,128), RGB (128,128,0), RGB (128,0,128), RGB (0,128,128), RGB (128,128,128)
		Input ID	Enable/Disable
		Details for Input	Enable/Disable
		ID Style	Input Format, Custom Format
		Input Label	HDMI1 ~ 2, SDI1 ~ 4
		VPID	Enable/Disable

Menu	Item 1	Item 2	Value
Advanced	Information	Device Name	
		Model Name	
		webOS Version	
		S/W Version	
		Serial Number	
		Micom Version	
		FPGA Version	
		Network Settings	
		Internal Memory	
		Temperature	
	Open Source Software Notice		
	Control	Front LED	Enable/Disable
		Auto Front Key Lock	Enable/Disable
		Auto IR Lock	Enable/Disable
	HDMI Ultra HD Deep Color	HDMI 1	Enable/Disable
		HDMI 2	Enable/Disable
	OLED Panel Settings	TPC Auto-dimming	Enable/Disable
		Pixel Refresher	Operate once when device is off, Start Now
		Screen Shift	Enable/Disable
		Logo Luminance Adjustment	Off, Low, High
		GSR Auto-dimming	Enable/Disable
		Convex Power Control	Enable/Disable
	Screen Saver		Enable/Disable
	No Signal Message		Enable/Disable
	Genlock		Enable/Disable
	Screen Control	Interlacing / De-interlacing Mode	Line Doubler, Inter Field, Field Merge
		Internal Pattern	Off, Auto Run, Color Bars, White, Black, Red, Blue, Green
	Power	Standby Mode When No Signal	Enable/Disable
		No IR Power Off (4hour)	Enable/Disable
	Network Settings	IPv6	Enable/Disable
		IP Address	
		Subnet Mask	
		Gateway	
DNS Server			
MAC Address			

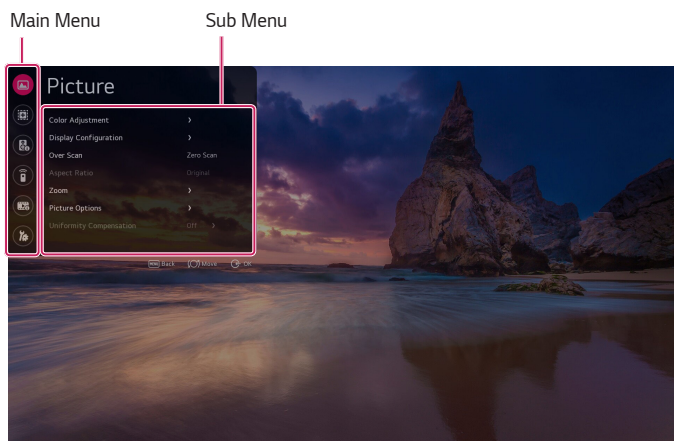

Menu	Item 1	Item 2	Value
Advanced	LG Connect		Enable/Disable
	Caption	Closed Caption	Enable/Disable
		Closed Caption Mode	708, 608 ANC, 608 Transcoded
		608 Caption Channel	CC1
		708 Caption Channel	Off, Service1
	Picture In Picture / Picture By Picture	PIP/PBP	Enable/Disable
		Type	
		Input Source	HDMI 1, HDMI2
		PIP Position	Left-Top, Right-Top, Left-Bottom, Right-Bottom
		PIP Transparency	0%, 25%, 50%, 75%
		PIP Swap	Swap
		Audio Select	Main, Sub
	Change Device Password		
	Factory Reset		

USER SETTINGS

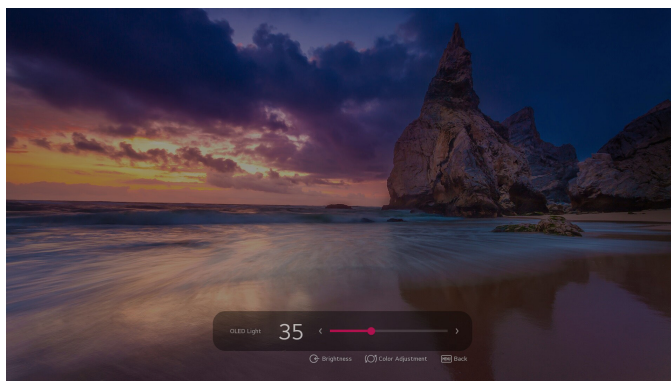

- How to adjust the menu
 - You can press the MENU button to launch the Settings menu.
 - Press the  / Dial button on the Main menu icon to go to the Submenu.
 - Pressing the MENU button while running the Setup menu moves you to the previous step.



- You can adjust the slider value by moving the remote control's     button or Dial up and down, and press the  / Dial button to move to the next slider.

Picture

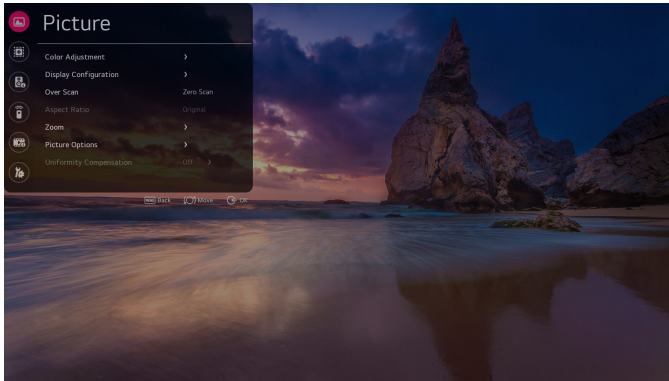

[Color Adjustment]

- [OLED Light]: Adjusts the brightness of the screen by adjusting the brightness of the OLED panel.
- [Brightness]: Adjusts the overall brightness of the screen. The closer the value to 100, the brighter the screen.
- [Contrast]: Adjusts the difference between the screen's light and dark areas. The closer the value to 100, the greater the difference.
- [Chroma]: Softens or deepens the Colors on the screen. The closer the value to 100, the deeper the Color.
- [Sharpness]: Adjusts the sharpness of the edges of objects. The closer the value to 50, the clearer and sharper the edges.
- [Tint]: Adjusts the balance between the levels of red and green Colors displayed on the screen. The closer to +50, the deeper the red, and the closer to -50, the deeper the green.
- [White Balance Control]: The function to adjust white balance.
 - [Color Temp]: The higher the Color temperature, the cooler the Color. The lower the Color temperature, the warmer the Color.
 - [VAR Temp]: Adjusts the Color temperature to the desired level. Enable this function by setting the [Color Temp] option to [VAR Temp].
 - [Method]: This method is for fine-tuning the color temperature setting, and for select the levels to adjust the color temperature. If [Method] is set to 2 Points, you can control Gain, Offset. If [Method] is set to 10,22 Points IRE, you can control white balance at each point of 10, 22 levels of the video.
 - Depending upon the selected [Method], the available options may differ. [Signal Level(%)], [Target Luminance], [Adjust Luminance], [Red/Green/Blue] will be shown, if [Method] is set to 10,22 Points.
 - [Signal Level(%): Select screen brightness for color temperature adjustment.
 - [Target Luminance]: Adjust the luminance to the highest IRE (100 Points).
 - [Adjust Luminance]: You can adjust brightness of the selected signal level.

[Display Configuration]

- [SDR / HDR Signal Format]: Select HDR, SDR signal format manually. Auto: use Video Information
 - [SDR Configuration]
 - [SDR Gamut]: Selects the Color Gamut for SDR input.
 - [SDR EOTF]: Selects the EOTF for SDR input.
 - [SDR EOTF User]: Adjusts the EOTF in the range of 0.8 ~ 3.0. It can be set in units of 0.1. It is activated when [SDR EOTF User] is selected as [User].
- [HDR Configuration]
 - [HDR Gamut]: Selects the Color Gamut for HDR input.
 - [HDR 1D LUT]: Selects the 1D LUT for HDR input.
 - [HDR Format]: selects the HDR format manually. Auto: use Video Information
 - [ST 2084 Tone Curve]: selects the ST 2084 Tone Curve
 - [BT.2100 HLG System Gamma]: selects the BT.2100 HLG system gamma setting.
 - [BT.2100 HLG System Gamma User]: Adjusts the HLG System Gamma in the range of 1.00 ~ 1.60. It can be set in units of 0.05. It is activated when [BT.2100 HLG System Gamma] is selected as [User].
 - [HDR Peak Brightness]: change peak brightness on HDR mode.
- [Dolby Vision Configuration]
 - [Dolby Vision 1D LUT]: Selects the 1D LUT for Dolby Vision input.
 - [Dolby Vision Parameters]: Selects the Parameters for Dolby Vision input.

! NOTE

- [ST.2084 PQ], [BT.2100 HLG], and [Dolby Vision] cannot be selected if [Internal Pattern] is turned on.
- [Transfer Matrix]: Sets the value for colorimetry, which is part of the HDMI Packet AVI Infoframe.
 - [Auto]: Sets to the colorimetry value received from the device.
 - [BT.601]: Sets the colorimetry value to BT.601.
 - [BT.709]: Sets the colorimetry value to BT.709.
 - [BT.2020]: Sets the colorimetry value to BT.2020.

! NOTE

- This feature works in HDMI, SDI, and SFP+.
- Colorimetry: Data indicating the Color space of the video. It is part of the metadata contained in the HDMI video format. (e.g., BT.601 → SD standard, BT.709 → HD / FHD standard, BT.2020 → UHD / HDR standard)

- [Mono / Blue Only]
 - [Off]: Disables [Mono / Blue Only].
 - [Mono Color]: Displays a single Color screen.
 - [Blue Color]: Displays only the blue signal on the screen.
- [Input Range]: Correct the darkness and contrast of the screen based on the input signal range. (Settings recommended based on input signal: RGB 0 – 255: High, RGB 16 – 235: Low, YCbCr: Low, RGB based on SDI Standard : SDI Full)

Available settings are as follows:

- [Auto]: Use this option to apply settings automatically based on the input signal. (Only one of [Narrow] and [Full] is selected, [SDI Full] is not automatically selected.)
- [Narrow]: Use this option for input signals in the 8-bit range limited to values 16 – 235 and 10bit range limited to values 64 - 940.
- [Full]: Use this option for input signals in the 8-bit range full values 0 – 255 and 10bit range full values 0 – 1023.
- [SDI Full]: Use this option for input signals in the 10-bit range limited to values 4 – 1019.
- [PQ Clip Point]: Sets the mastering peak, value, which is part of the HDMI HDR packet metadata.
 - [700]: Sets the mastering peak value to 700
 - [1000]: Sets the mastering peak value to 1000
 - [2000]: Sets the mastering peak value to 2000
 - [3000]: Sets the mastering peak value to 3000
 - [4000]: Sets the mastering peak value to 4000
 - [10000]: Sets the mastering peak value to 10000

NOTE

- This feature works in only HDR10 signal.

NOTE

- HLG is a type of HDR, but the signal packets in this format do not contain metadata. Since the tone curve is fixed according to the mastering peak information, image quality does not change according to the mastering peak.
- The corresponding settings can be changed with no signals in HDMI, SDI, SFP+ or with signals in SDR / HLG / Dolby; however, the actual image quality settings are applied when running in HDR.
- [SDI Color Format]: Sets the pixel encoding value, which is part of the SDI Packet AVI Infotable.
 - [Auto]: Sets to the pixel encoding value received from the device.
 - [RGB444]: Sets the pixel encoding value to RGB444.
 - [YCbCr444]: Sets the pixel encoding value to YCbCr444.
 - [YCbCr422]: Sets the pixel encoding value to YCbCr422.

NOTE

- This feature works in SDI and SFP+.

[Over Scan]

Select a scan mode for image output.

- [Zero Scan]: Displays 100 % of the original image size.
- [Over Scan]: Displays 95 % of the original image size.
- [Under Scan]: Displays 105 % of the original image size.

NOTE

- [Over Scan] is deactivated when any of the features below have been enabled.
 - [HDR / SDR Monitoring]
 - [Internal Pattern]
 - [PBP]

When deactivated, [Over Scan] is set to [Zero Scan].

[Over Scan] returns to the setting previously set by the user upon reactivation.

- [Over Scan] may work differently depending on the [Screen Shift] settings.
- When using [PIP], this feature applies only to the main screen.

[Aspect Ratio]

The screen size can be adjusted to the set ratio.

- [Full Wide] : Sets the screen size to full wide.
- [4 : 3]: Sets the screen size to 4 : 3.
- [14 : 9]: Sets the screen size to 14 : 9.
- [13 : 9]: Sets the screen size to 13 : 9.
- [1.85 : 1]: Sets the screen size to 1.85 : 1.
- [2.35 : 1]: Sets the screen size to 2.35 : 1.
- [1 : 1]: Sets the screen size to 1 : 1.
- [Original]: Sets the screen size to original.
- [Auto]: Sets the screen size according to the input source information.

NOTE

- Screen Size can be adjusted sequentially by registering Screen Size values to the Function keys and GPI settings.
- When [Aspect Ratio] is set to [1 : 1], the items below are disabled.
 - [Over Scan]
 - [Noise Reduction]
 - [MPEG Noise Reduction]
 - [Real Cinema]
 - [Smooth Gradation]
 - [Screen Shift]
 - [Logo Luminance Adjustment]
 - [GSR Auto-dimming]
 - [Convex Power Control]
- When [Aspect Ratio] is set to [Auto], If the input source does not have any screen ratio information, the screen ratio is adjusted to [Full Screen]
- This feature is not available when running [HDR / SDR Monitoring] / [Internal Pattern] / [PBP].
- When using [PIP], this feature applies only to the main screen.

[Zoom]

Zoom into the current external input image.

- [2x Zoom]: The original image is enlarged 2x by dividing the external input into a 2 x 2 grid.
- [3x Zoom]: The original image is enlarged 3x by dividing the external input into a 3 x 3 grid.
- [4x Zoom]: The original image is enlarged 4x by dividing the external input into a 4 x 4 grid.
- [5x Zoom]: The original image is enlarged 5x by dividing the external input into a 5 x 5 grid.
- * Supported External Input: HDMI1 - 2, SDI1 - 4, SFP+, SDI Dual Link, Quad Link, Quad View
- * When selecting a zoom factor, a square is drawn over the image, indicating the area on which to zoom in.
 - Turn the Dial key or use the Up / Down keys on the remote control to change the area on which to zoom in.
 - When the Dial key or the OK key on the remote control is pressed, the selected area is enlarged, and the zoom factor with the currently zoomed area is displayed in the lower left corner of the screen.
 - With the image enlarged, turn the Dial key or use the Up / Down keys on the remote control to change the area on which to zoom in.
 - When using the Dial key, turn to the right (clockwise) to move to the right and turn to the left (counter-clockwise) to move to the left.
 - When using the remote control, press the Down / Right keys to move to the right and the Up / Left keys to move to the left.
 - Pressing the Down key while the image is enlarged restores the image and returns to the screen for area selection.
 - Pressing the Exit key on the remote control while the image is enlarged closes the zoom settings menu and restores the image.

NOTE

- The [Zoom] feature cannot be used without a signal or in unsupported resolutions.
- When [Zoom] is applied and GPI signals are entered, the features mapped to the GPIs are as follows:
 - Undefined: No action.
 - Power Key: Turns power on / off.
 - Input Device: Removes [Zoom] and switches input to the corresponding input. If it is the same as the current input, only [Zoom] is removed.
 - Menu Key, Enter Key, Up / Down Key
 - Function Key: Removes [Zoom] and executes the feature mapped to the [Function Key].
 - [Over Scan], [Aspect Ratio], [Waveform]: Removes [Zoom], returns to the previous screen before applying [Zoom], and runs the corresponding feature.

[Picture Options]

- [Noise Reduction]: Removes irregularly generated tiny dots for a clearer picture.
- [MPEG Noise Reduction]: Reduces the noise produced during the generation of digital video signals.
- [Real Cinema]: Optimises the screen for movie viewing.
- [Motion Eye Care]: Adjusts brightness and image blurring based on the image information in order to reduce eyestrain.
- [Dynamic Tone Mapping]: Sets an appropriate contrast according to the image brightness of the HDR content.
- [Dynamic Contrast]: Optimises the difference between the light and dark areas of the screen based on the brightness of the image.
- [Dynamic Color]: Adjusts the tint and saturation of the image for a more vivid and vibrant display.
- [Smooth Gradation]: Reduces any jagged effect to achieve smooth screen gradation.

[Uniformity Compensation]

Evens out luminance / Color across the panel using SuperSign WB.

Marker

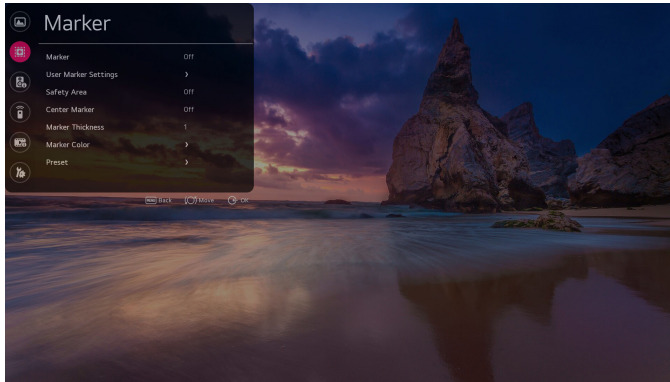

[Marker]

Check the ratio for the image displayed on the screen in advance.

- [Off]: Disables the marker (Default)
- [16 : 9]: Displays a ratio of 16 : 9 (3840 x 2160) on the screen.
- [4 : 3]: Displays a ratio of 4 : 3 (2880 x 2160) on the screen.
- [14 : 9]: Displays a ratio of 14 : 9 (3360 x 2160) on the screen.
- [13 : 9]: Displays a ratio of 13 : 9 (3120 x 2160) on the screen.
- [1.85 : 1]: Displays a ratio of 1.85 : 1 (3840 x 2075) on the screen.
- [2.35 : 1]: Displays a ratio of 2.35 : 1 (3840 x 1634) on the screen.
- [User Marker 1]: Displays the ratio set for Custom Marker 1 on the screen.
- [User Marker 2]: Displays the ratio set for Custom Marker 2 on the screen.
- [User Marker 3]: Displays the ratio set for Custom Marker 3 on the screen.

[User Marker Settings]

Set the ratio for the custom marker.

- Width: Sets the width to be applied to the custom marker. The range can be set in increments of four, from 0 to 3840. (Default: 1920)
- Height: Sets the height to be applied to the custom marker. The range can be set in increments of four, from 0 to 2160. (Default: 1080)



[Safety Area]

Check the scan ratio of images to be displayed on the screen in advance.

- [Off] : Disables the safety zone (Default).
- [16 : 9, 95%]: Displays the ratio of 16 : 9 at 95 % (3648 x 2052).
- [16 : 9, 93%]: Displays the ratio of 16 : 9 at 93 % (3570 x 2008).
- [16 : 9, 90%]: Displays the ratio of 16 : 9 at 90 % (3456 x 1944).
- [16 : 9, 88%]: Displays the ratio of 16 : 9 at 88 % (3378 x 1900).
- [16 : 9, 85%]: Displays the ratio of 16 : 9 at 85 % (3264 x 1836).
- [16 : 9, 80%]: Displays the ratio of 16 : 9 at 80 % (3072 x 1728).
- [4 : 3, 95%]: Displays the ratio of 4 : 3 at 95 % (2736 x 2052).
- [4 : 3, 93%]: Displays the ratio of 4 : 3 at 93 % (2678 x 2008).
- [4 : 3, 90%]: Displays the ratio of 4 : 3 at 90 % (2592 x 1944).
- [4 : 3, 88%]: Displays the ratio of 4 : 3 at 88 % (2534 x 1900).
- [4 : 3, 85%]: Displays the ratio of 4 : 3 at 85 % (2448 x 1836).
- [4 : 3, 80%]: Displays the ratio of 4 : 3 at 80 % (2304 x 1728).

[Center Marker]

Place a marker at the center of the screen.

- [Off]: Disables the center marker (Default).
- []: Sets the Center marker to the type1.
- []: Sets the Center marker to the type2.
- []: Sets the Center marker to the type3.

[Marker Thickness]

Set the thickness of the marker.

The thickness can be set from 1 to 10, with a default value of 1.

[Marker Color]

Set the Color of the marker and the safety zone.

[Line Color]

Set the line Color of the marker.

- [White]: Set the line Color of the marker to white (default).
- [Yellow]: Set the line Color of the marker to yellow.
- [Blue]: Set the line Color of the marker to blue.
- [Red]: Set the line Color of the marker to red.
- [Black]: Set the line Color of the marker to black.

[BG Color]

This feature is used to set the background Color of the marker.

- [None]: No background Color (default)
- [Grey]: Set the background Color of the marker to grey.
- [White]: Set the background Color of the marker to white.
- [Blue]: Set the background Color of the marker to blue.
- [Black]: Set the background Color of the marker to black.

[BG Transparency]

When setting the background Color of the marker, the transparency of the background can be adjusted.

Set in increments of 20 %, ranging from 0 to 100 % with a default value of 0 %.

[Center Marker Color]

Set the line Color of the center marker.

- [White]: Set the line Color of the center marker to white (default).
- [Yellow]: Set the line Color of the center marker to yellow.
- [Blue]: Set the line Color of the center marker to blue.
- [Red]: Set the line Color of the center marker to red.
- [Black]: Set the line Color of the center marker to black.

[Preset]

Save frequently used settings for the marker, safety zone, and center marker as a preset so that they can be applied at once.

A marker preset can store two values.

Audio

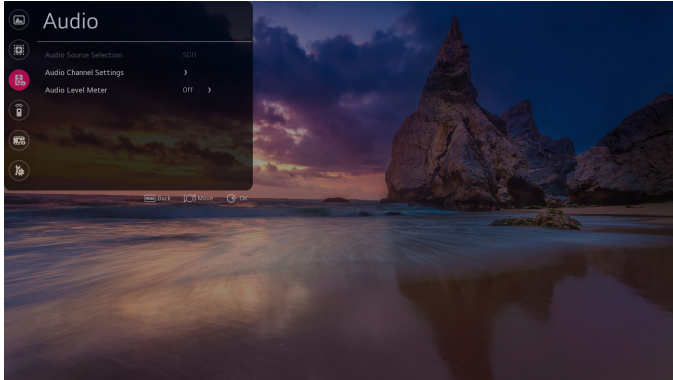

[Audio Source Selection]

Audio is outputted from the selected SDI input source.

The Audio Level Meter measures the audio level for the corresponding SDI audio and displays it on the screen.

- [SDI1]: Select the SDI1 input source for which to measure the audio level.
- [SDI2]: Select the SDI2 input source for which to measure the audio level.
- [SDI3]: Select the SDI3 input source for which to measure the audio level.
- [SDI4]: Select the SDI4 input source for which to measure the audio level.
- [SFP+]: Select the SFP+ input source for which to measure the audio level.

[Audio Channel Settings]

Select the audio input channel for the preferred headphone output (stereo).

A graph is displayed measuring the audio levels of 16 channels, with eight channels on the left and eight channels on the right.

- [Left Channel]: Select the audio input channel to output to the left headphone.
- [Right Channel]: Select the audio input channel to output to the right headphone.

[Audio Level Meter]

- [Audio Level Meter]: Shows audio broadcast signals on the screen through the audio level meter.
- [Audio Level Meter Type] : Select the direction of the bar graph to show the audio level meter on the screen.
- [Audio Channel Selection] : Select the audio channel you want to output on the audio level meter screen.
 - The selected Audio Channel Selection value determines the audio channel output on the screen.

Audio Channel Selection	Display on the Left	Display on the Right
Full	CH1~CH8	CH9~CH16
Group1	CH1+CH2	CH3+CH4
Group2	CH5+CH6	CH7+CH8
Group3	CH9+CH10	CH11+CH12
Group4	CH13+CH14	CH15+CH16

- Set to 'User Group' allows to select the audio channel want to output directly on the screen.

Audio Channel Selection	Display on the Left	Display on the Right
User Group	Off	Off
	CH1+CH2	CH1+CH2
	CH3+CH4	CH3+CH4
	CH5+CH6	CH5+CH6
	CH7+CH8	CH7+CH8
	CH9+CH10	CH9+CH10
	CH11+CH12	CH11+CH12
	CH13+CH14	CH13+CH14
	CH15+CH16	CH15+CH16

- [Audio Level Meter Position]: Select where to display the audio level meter on the screen.
- [Audio Level Meter Size]: Set the size of the bar graph to show the audio level meter on the screen.

! **NOTE**

- For Quad View output, the audio output and audio level meter output for a specific input source can be selected from the Audio Source Selection menu.
- For Single Link / Dual Link / Quad Link, the Audio Source Selection menu is disabled, and the feature for selecting the audio source based on the current input is automatically enabled.

Screen Output	Auto-selected in Audio Source
SDI1	SDI1
SDI2	SDI2
SDI3	SDI3
SDI4	SDI4
SFP+	SFP+
Dual Link (SDI1 & 2)	SDI1
Dual Link (SDI3 & 4)	SDI3
Quad Link: Auto	SDI1
Quad Link: 2SI	SDI1
Quad Link: Square	SDI1
SDI Quad View	Previously set Audio Source Selection values

- Audio Level Meter is deactivated if any of the features below have been enabled.
 - HDMI Output Screen
 - When running Caption / HDR / SDR Monitoring / Waveform

GPI

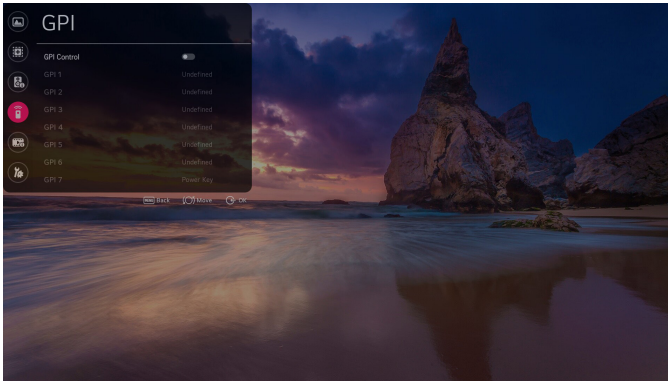

Assign frequently used features to GPIs (General Purpose Interface) 1 to 7.

Each GPI can send a signal to execute the feature assigned to it.

- The features that can be assigned to GPIs 1 to 6 are as follows:
 - [Undefined]: No feature is assigned.
 - [Marker Preset 1]: Change the current marker information to the value stored in Marker Preset 1.
 - [Marker Preset 2]: Change the current marker information to the value stored in Marker Preset 2.
 - [Marker]: Change the marker options.
 - [Center Marker]: Set the center marker.
 - [Safety Area]: Change the safety zone.
 - [Tally R]: Sets Tally R.
 - [Tally G]: Sets Tally G.
 - [Input HDMI1]: Switches input to HDMI1.
 - [Input HDMI2]: Switches input to HDMI2.
 - [Input SDI 1]: Switches input to SDI1.
 - [Input SDI 2]: Switches input to SDI2.
 - [Input SDI 3]: Switches input to SDI3.
 - [Input SDI 4]: Switches input to SDI4.

- [Input Dual Link (SDI 1&2)]: Switches input to Dual Link (SDI1 & 2).
- [Input Dual Link (SDI 3&4)]: Switches input to Dual Link (SDI3 & 4).
- [Input Quad Link : Auto]: Switches input to Quad Link: Auto.
- [Input Quad Link : 2SI]: Switches input to Quad Link: 2SI.
- [Input Quad Link : Square]: Switches input to Quad Link: Square.
- [Input SDI Quad View]: Switches input to SDI Quad View.
- [Input SFP+]: Switches input to SFP+.
- [Over Scan]: Change the Scan settings.
- [Aspect Ratio]: Change the Screen Size settings.
- [Menu Key]: Set the Menu key.
- [Enter Key]: Set the OK key.
- [Up Key]: Set the Up key.
- [Down Key]: Set the Down key.
- [Function Key 1]: Set Function key 1.
- [Function Key 2]: Set Function key 2.
- [Function Key 3]: Set Function key 3.
- [Function Key 4]: Set Function key 4.
- [Function Key 5]: Set Function key 5.
- [Waveform]: Change the waveform options.
- GPI 7 is always set as [Power Key].
 - [Power Key]: Turns power on or off.

! NOTE

- Changing High to Low for a GPI executes the feature assigned to the GPI.
- GPIs cannot be used to execute a disabled feature, even if it is assigned to the GPI.
- When using [Zoom], the actions of the features assigned to GPIs are as follows:

Action	Feature
No action.	Undefined
Power On / Off	Power Key
Turns off Zoom and executes the feature.	Input HDMI1, Input HDMI2, Input SDI1, Input SDI2, Input SDI3, Input SDI4, Input Dual Link (SDI1 & 2), Input Quad Link: Auto, Input Quad Link: 2SI, Input Quad Link: Square, Input SDI Quad View, Input SFP+, Over Scan, Screen Size, Function key 1, Function key 2, Function key3, Function key 4, Function key 5, Waveform
Feature is executed while Zoom is turned off.	Marker Preset 1, Marker Preset 2, Marker, Center Marker, Safety Zone, Tally R, Tally G, Menu key, OK key, Up key, Down key

Video Analysis

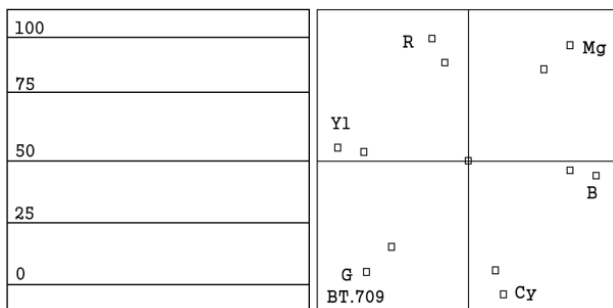
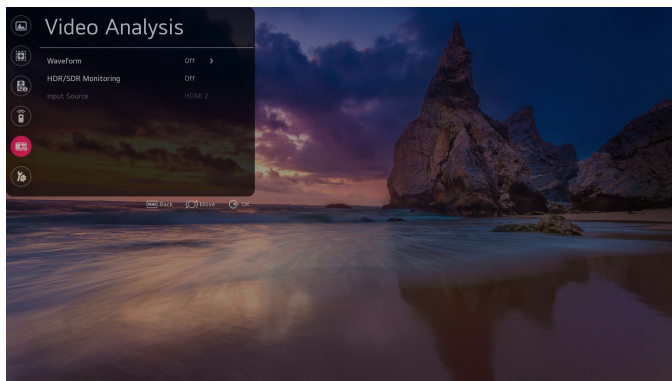

[Waveform]

View the luminance information of the current input picture as a waveform. View the saturation components through a vectorscope.

Select a graph type.

- [Off]: Turns off Waveform.
- [WF (Waveform)]: Turns on Waveform.
- [VT (Vectorscope)]: Turns on Vectorscope.
- [WF + VT]: Turns on Waveform and Vectorscope.

- [Vector Color]: Select a background Color for the vectorscope.
 - [On/Off]: Turns on / off the vectorscope background Color.
 - [Position]: Select a location to display the graph.
 - [Left-Top]: Set the graph location to the top left corner.
 - [Right-Top]: Set the graph location to the top right corner.
 - [Left-Bottom]: Set the graph location to the bottom left corner.
 - [Right-Bottom]: Set the graph location to the bottom right corner.
 - [Size]: Select size of the graph.
 - [Small]
 - [Large]
 - [Transparency]: Adjusts the transparency level of the graph.
 - [Off]: Transparency not set.
 - [25%]: Sets transparency to 25 %.
 - [50%]: Sets transparency to 50 %.
 - [75%]: Sets transparency to 75 %.
- * Supported Input: SDI1, SDI2, SDI3, SDI4, SFP+, Dual Link, Quad Link

[HDR / SDR Monitoring]

When the input signal for the main screen is HDR, the screen can be divided in half to compare HDR / SDR at the same time.

- [Off] : Turns off HDR / SDR Monitoring
- [1 Source Mode] : Turns on 1 source HDR / SDR Monitoring
- [2 Source Mode] : Turns on 2 source HDR / SDR Monitoring

NOTE

- Supported Input: HDMI1, HDMI2, SDI1, SDI2, SDI3, SDI4, SFP+, Dual link, Quad link
 - Representative resolution: Supports signals 720 p (HD) or higher.
 - Unsupported resolution: 480 p (SD)
 - If the input signal is not HDR, there is no difference in the image quality of the screen.
 - Marked HDR / SDR regardless of the input signal.
 - Using [Waveform], [Picture In Picture / Picture By Picture] or [Audio Level Meter] disables this feature.
 - Using this feature disables [Over Scan], [Aspect Ratio], and [Zoom].
 - HDMI1, HDMI2, SDI1, SDI2, SDI3, SDI4, SFP+, Dual link, and Quad link support HLG and HDR10.

[Input Source]

Select the input to show on the sub screen when HDR / SDR Monitoring is 2 Source Mode

! NOTE

- Only the combinations of HDMI and SDI or HDMI and SFP+ are allowed.

Main Screen Input	Sub screen Input List
HDMI1	HDMI2, SDI1, SDI2, SDI3, SDI4, SFP+
HDMI2	HDMI1, SDI1, SDI2, SDI3, SDI4, SFP+
SDI1	HDMI1, HDMI2
SDI2	HDMI1, HDMI2
SDI3	HDMI1, HDMI2
SDI4	HDMI1, HDMI2
SFP+	HDMI1, HDMI2

- The sub screen supports progressive signals only.
- The sub screen does not support SDI interlaced signals.
- The sub screen does not guarantee normal operation of PsF signals.

Advanced Settings

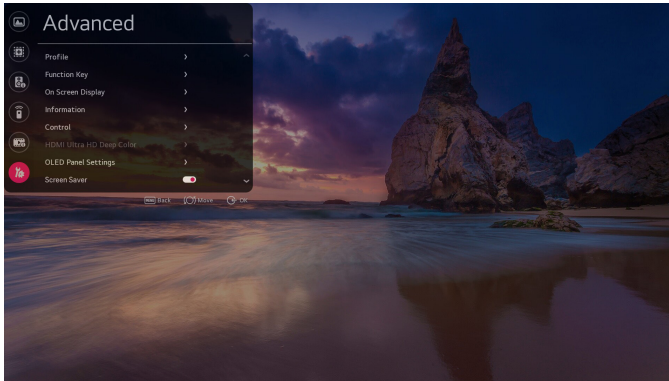

Profile

This feature allows the user to save his or her preferred settings and load them at any time.

[Load Profile]

Retrieve and load specific user settings to the device and make them available by saving them as [Profile]. If no settings have been saved by the user, the default settings are loaded.

- [Profile] saved by the user are displayed as icons.
- When selecting [Profile], a password input window appears at the bottom of the screen. The passwords must match in order for the selected [Profile] to load.
- The password input window does not appear for [User Settings] that have never been saved.
- After three consecutive failed login attempts, the password input window turns off and returns to the [Load Profile] screen.

- Items Displayed in User Settings
 - OLED Light
 - Brightness
 - Contrast
 - Chroma
 - Sharpness
 - Tint
 - Color Temperature
 - SDR Gamut
 - SDR EOTF
 - HDR Gamut
 - HDR 1D LUT
 - Dolby Vision 1D LUT
 - Dolby Vision Parameters
 - PQ Clip Point
 - SDI Color Format
 - Over Scan
 - Aspect Ratio

[Save as Profile]

Save the settings in the current device onto each user setting.

- User Settings saved through the Save User Settings function are displayed as icons.
- When selecting [Profile] to save the current setting, a password input window appears at the bottom of the screen. The passwords must match in order for the current setting to be saved in the selected [Profile].
- Passwords can be set for [Profile] that have never been saved.

[Reset Profile]

User settings that have been saved by the user are reset and returned to default.

[Change Profile Password]

Change the password for user settings.

- In order to do this, enter the initial password first.
- The initial password can be found in [Change Device Password].

[Option for Loading Saved Profiles]

Set the option for loading saved profiles.

- [Load without Entering Password] : You can load the saved profile without entering a password.

[Function Key]

Assign frequently changed features to the Function keys in the local key bar and use them like hot keys. Assign features to Function keys 1 to 5, respectively, from the menu.

The features that can be assigned are as follows:

- Undefined: No feature assigned
- Marker: Changes marker options
- Safety Zone: Changes safety zone options.
- Marker Preset 1: Changes the current settings of the marker to those stored in Marker Preset 1.
- Marker Preset 2: Changes the current settings of the marker to those stored in Marker Preset 2.
- Aspect Ratio: Changes screen size options.
- Audio Level Meter: Turns the audio level meter on and off (does not work with HDMI input).
- Solid / Blue Mode: Changes solid / blue mode options.
- Waveform: Changes waveform options (for SDI input only).
- Vectorscope Color: Turns on / off vectorscope Color.
- Time Code: Changes time code options
- EOTF: Changes EOTF options.
- Interlacing / De-interlacing Mode: Changes Interlacing / De-interlacing Mode options.

NOTE

- Only [Marker] is supported when [Internal Pattern] is running.

[On Screen Display]

[Menu Option]

- [Menu Language]: Select the language for the menu.
- [Menu Position]: Select the location for the menu.
- [Menu Transparency]: Sets the background transparency of the menu.

[Time Code]

- [Time Code]: Activates the Time Code feature.
- [Time Code Size]: Sets the Time Code size.
- [Time Code Position]: Sets the Time Code location
 - Top Left: Sets the Time Code location to the top left corner.
 - Top Center: Sets the Time Code location to the top center.
 - Top Right: Sets the Time Code location to the top right corner.
 - Bottom Left: Sets the Time Code location to the bottom left corner.
 - Bottom Center: Sets the Time Code location to the bottom center. (Default)
 - Bottom Right: Sets the Time Code location to the bottom right.
- [Time Code Transparency]: Sets the background transparency of the Time Code.
- [VITC Line]: Sets the VITC Line

[UMD]

Check which camera is connected and being used to take pictures.

- [UMD] (Toggle On / Off): Activates the UMD feature.
- [UMD Character]: Sets the text for the UMD.
- [UMD Position]: Sets the UMD location.
 - Left-Top: Sets the UMD location to the top left corner.
 - Center-Top: Sets the UMD location to the top center.
 - Right-Top: Sets the UMD location to the top right corner.
 - Left-Bottom: Sets the UMD location to the bottom left corner.
 - Center-Bottom: Sets the UMD location to the bottom center. (Default)
 - Right-Bottom: Sets the UMD location to the bottom right.
- [UMD FG Color]: Sets the text Color of the UMD.
- [UMD BG Color]: Sets the background Color of the UMD.

[Input ID]

- [Details for Input]: View detailed information on the input signal.
 - [Off]: Does not show the details of the input.
 - [On]: Shows the details of the input.
 - HDMI Input: Input Signal, Resolution, Frequency, Color format, Color Space, Black Level, HDR
 - Color Format: NODATA, SMPTE170, ITU709, FUTURE
 - Color Space: RGB, YCbCr444, YCbCr422, YCbCr420
 - Black Level: FULL, LIMITED
 - SDI Input: Input Signal, Resolution, Frequency, Colorimetry, Sampling (same information as VPID)
- [ID Style]: Sets how to display the name of the input in the banner.
 - Input format: Use the input signal name as it is.
 - Custom Format: Use the name set in the input label.
- [Input Label]: Sets the name of the input to be displayed in the banner.

[VPID]

Check the status of SDI signals sent by FPGA.

- [Off]: Does not show SDI signal status.
- [On]: SDI signal status is shown for three seconds and disappears.

**NOTE**

- Displayed Information
 - Transport
 - Picture
 - Transfer
 - Picture Rate
 - Aspect Ratio
 - Colorimetry (Output value type: Rec. 709 / Rec. 2020 / Rec. 2100)
 - Sampling
 - Bit Depth
 - VPID
- Supported Input Signal: SDI, SFP+
- Some VPID information may not be displayed, depending on the signal.

[Information]

Check the device information.

[Control]

- [Front LED]: Turns on or off all Control Box LEDs.
- [Auto Front Key Lock]: When this feature is set to ON, Front keys will be locked when there is no Front key input for 30 seconds.
 - Locks all keys except the Power key.
 - Press and hold the Menu key for five seconds to unlock the keys. If this feature is set to OFF, locking does not work, even when there is no Front key input.
- [Auto IR Lock]: When this feature is set to ON, the remote control goes into locked mode if there is no remote control input for three minutes. Unlock the remote control by pressing the numbers 1, 2, 3, and 4 on the remote control in order. When this feature is set to OFF, locking does not work, even if there is no remote control input.

[HDMI Ultra HD Deep Color]

If the user has a digital input (HDMI1, 2) device connected to one of the ports with adjustable deep Color, UHD Deep Color On (6G) or Off (3G) can be selected from the ULTRA Deep Color Settings menu.

If compatibility issues occur with the graphics card when the Deep Color option is set to On at 3840 x 2160 @ 60 Hz, set the option to Off.

- HDMI inputs 1 and 2 are best suited for 4K at 60 Hz (4:4:4, 4:2:2) to enjoy high definition video. However, video or audio may not be supported, depending on the specifications of the external devices. In that case, please connect to another HDMI port.

[OLED Panel Settings]

- [TPC(TemporalPeak Luminance Control) Auto-dimming]: Lowers the brightness to protect the screen when a static image is detected.
- [Pixel Refresher]: Corrects any issues that may arise on the screen when the TV has been turned on for a long time. This may take more than an hour.
- [Screen Shift]: Moves the screen slightly at regular intervals to prevent image sticking on the display panel.
- [Logo Luminance Adjustment]: Adjusts the luminance of static images such as on-screen logos to correct potential screen issues.
- [GSR (Global Sticky Reduction) Auto-dimming]: Gradually reduces the luminance of the screen when a specific area on the screen has a fixed image for a certain period of time without changing.
- [Convex Power Control]: The brightness of the central part of the screen is expressed as 100 %, and the farther away from the center, the darker it is because of the Gradation Gain applied to the image for reducing power consumption.

! NOTE

The features below may work differently depending on [Screen Shift] settings.

- [Aspect Ratio] and [Over Scan] Behaviour
 - When [Over Scan] is set to [Zero Scan], the features behave as follows, depending on [Aspect Ratio]:
 - When [Aspect Ratio] is set to [16:9] → The existing screen settings apply, regardless of [Screen Shift] settings.
 - When [Aspect Ratio] is set to a value other than [16:9] → The image is enlarged when [Screen Shift] is set to [On].
 - When [Over Scan] is set to [Over Scan] → The image is enlarged when [Screen Shift] is set to [On].
 - When [Over Scan] is set to [Under Scan] → The image is enlarged when [Screen Shift] is set to [On].
- [Zoom]
 - When [Screen Shift] is set to [On], the area set for [Zoom] moves along whenever the screen moves.
- [Marker]
 - When [Screen Shift] is set to [On], the area indicated by [Marker] moves along whenever the screen moves.

[Screen Saver]

- Prevent afterimage or overuse of panels using the screen protection feature when there is no signal.
- On: Runs the screensaver if there is no signal for 130 seconds (default)
- Off: Screensaver is disabled.

[No Signal Message]

Set the [no signal message] function to On or Off.

- On: Enable no signal message (default).
- Off: Disable no signal message.

[Genlock]

When the Genlock signal is connected to the REF IN port and the Genlock feature is turned on, the monitor can use the video signal synchronisation feature.

[Screen Control]

[Interlacing / De-interlacing Mode]

Set the output mode for interlaced pictures.

- Line Doubler: Mode that outputs the top / bottom fields of interlaced signals by processing them to be vertically doubled
- Inter Field: Mode that outputs only the top fields of interlaced signals by processing them to be vertically doubled
- Field Merge: Mode for deinterlacing the interlaced signals

[Internal Pattern]

- This feature is used to show patterns stored in the device.
- Off: Turns off the internal pattern feature. (Default)
- Auto Run: Shows internal patterns in order at five second intervals. (Color bar - White - Black - Red - Blue - Green - Color Bar...)
- Color Bar: Shows the Color bar pattern.
- White: Shows the white pattern.
- Black: Shows the black pattern.
- Red: Shows the red pattern.
- Blue: Shows the blue pattern.
- Green: Shows the green pattern.

[Power]

[Standby Mode When No Signal]

Set whether or not to enable the feature for forcing shutdown after ten seconds.

- The feature is set to [On] or [Off].
- When set to [On], the product turns off if there is no signal for ten seconds.
- When set to [Off], the feature for forcing shutdown after ten seconds is disabled.
- It is recommended that the feature be set to [Off] when the product is to be used for a long time since it is a power-off function.

[No IR Power Off (4hour)]

Set whether or not to enable the feature for forcing shutdown after four hours.

- The feature is set to [On] or [Off].
- When set to [On], the product turns off when there is no input from the remote control for four hours.
- When set to [Off], the feature for forcing shutdown after four hours is disabled.
- It is recommended that the feature be set to [Off] when the product is to be used for a long time because it is a power-off function.

[Network Settings]

Connect to the Local Area Network (LAN) through the LAN port, and set up the network. Once a physical connection is established, the device automatically connects to most networks without any adjustment. In some networks, the device settings may need to be adjusted. For more information, contact your Internet service provider or refer to the router's manual.

! NOTE

- If connected to a network that supports IPv6, it is also possible to view IPv6 network connection information from a wired network connection. However, IPv6 connections only support automatic connections.

[LG Connect]

- Sets the [LG Connect] function to On or Off.
- You can connect device via Promota, Calman API and WebApp API.
- Default setting is 'Off'.

[Caption]

This feature is used to show closed captions on the screen.

- Closed Caption (Toggle On / Off): Enable closed captions.
- Closed Caption Mode: 708 / 608 Transcoded / 608 ANC captions are available for selection.
- 608 Caption Channel: CC1
- 708 Caption Service: off/Service1

[Picture In Picture / Picture By Picture]

- [PIP / PBP]: Output an image from another input source to the sub screen.
 - [On]: Enables PIP / PBP.
 - [Off]: Disables PIP / PBP.
- [Type]: Sets the size of the sub screen.
- [Input Source]: Select the input to show on the sub screen.
- [PIP Position]: The location of the sub screen can be set when [Type] is PIP.
- [PIP Transparency]: The transparency of the sub screen can be set when [Type] is PIP.
- [PIP Swap]: It is possible to switch between the main screen and sub screen when [Type] is PIP.
- [Audio Select]: It is possible to select from the main screen audio and sub screen audio.

NOTE

- Only the combinations of HDMI and SDI or HDMI and SFP+ are allowed.

Main Screen Input	Sub screen Input List
HDMI1	HDMI2, SDI1, SDI2, SDI3, SDI4, SFP+
HDMI2	HDMI1, SDI1, SDI2, SDI3, SDI4, SFP+
SDI1	HDMI1, HDMI2
SDI2	HDMI1, HDMI2
SDI3	HDMI1, HDMI2
SDI4	HDMI1, HDMI2
SFP+	HDMI1, HDMI2

- The sub screen supports progressive signals only.
- The sub screen does not support SDI interlaced signals.
- The sub screen does not guarantee normal operation of PsF signals.

[Change Device Password]

Change the password used in the Settings menu. (Initial Password: 000000)

[Factory Reset]

All settings in [Settings] and internal memory files are reset.

Calibration

[CalMan Support]

The 65EP5G supports automated color calibration using CalMan software by Portrait Displays, Inc. (purchased separately: <https://www.portrait.com/calman-calibration-software/>). CalMan auto-calibration adjusts the monitor's internal 1D and 3D LUTs for precise color calibration.

Ensure the monitor and PC with CalMan are connected to the same local area network (LAN). Select the "Display Specific → Autocal – LG" workflow in CalMan and follow CalMan's instructions to calibrate the monitor. Connecting to CalMan will require the 65EP5G's IP Address. Once the monitor is connected to LAN, navigate in the 65EP5G menu to "Advanced → Network Settings" to view the IP Address.

Each of the 65EP5G's 10 Profiles can be calibrated separately, in both SDR and HDR mode, by selecting the profile number in CalMan. Once a profile has been calibrated, it can be selected through the monitor's menu under "Advanced → Profile". Profile selection may also be assigned to a Function Key.

NOTE

- CalMan does not support connections via IPv6.

[Colorimeter Profiling]

When a colorimeter is used to measure displays, best practice is to calibrate the colorimeter to each individual display using a more accurate device. This practice called colorimeter profiling. The typical method of colorimeter profiling uses a 3x3 correction matrix to account for errors in the colorimeter's spectral response to a display's three primary light elements. Colorimeter profiling functionality is often included in software provided with the measurement device and in display calibration software.

The 65EP5G panel uses a white sub-pixel in addition to red, green, and blue sub-pixels. Because the panel has four light elements, the traditional method of colorimeter profiling using a single 3x3 matrix can cause large measurement errors when used with the 65EP5G. When profiling a colorimeter for the 65EP5G, an approach called the Three-Matrix Method (or "Bodner Method") should be used to achieve accurate measurements. This approach is supported in CalMan with the "Tools → Meter Profiling" workflow, by selecting "Bodner Method (RGBW OLED)" for the "Generate Profile Matrix" setting on the "Create Meter Profile" page.

[Metameric Offset]

The perceived white point of the 65EP5G may not match the measured white point. The mismatch is a result of observer metamerism, which affects all wide color gamut displays in this way. Two calibrated displays may visually appear to have different white points despite having the same measured chromaticity, due to a difference in their spectral emittance. White points that visually match between displays for one person may be a visual mismatch for a different person.

To account for observer metamerism, the white point of the 65EP5G can be fine-tuned after calibration to visually match the white point of second monitor using these steps:

- Calibrate the 65EP5G in Calman, using the same target white point and luminance as the second monitor
- Display a white patch on both the 65EP5G and the second monitor
- In the 65EP5G menu, navigate to the "Picture → Color" menu
- Change the "Color Temp" setting to "VAR Temp"
- Adjust the "R-Gain", "G-Gain", and "B-Gain" settings until the white point of the 65EP5G visually matches the white point of the second monitor
- Adjusting the RGB Offset controls is not recommended for white point adjustment

TROUBLESHOOTING

- » Each model may have different points to check.
- » For information on your PC settings, refer to the Windows Help.

Issues Related to Use

- The power won't turn on.
 - Check if the power cord is correctly plugged into the power outlet.
 - Try turning the power on after disconnecting the AC adapter and cleaning the contacting port.
- The 'Unknown Product' message appears when the product is connected.
 - Check if the driver of PC (graphics card) has been installed.
 - Check if the plug and play function is supported by the PC (graphics card) user manual.

Issues Related to Screen (Video)

- A message saying 'No signal' or 'Invalid Format' appears.
 - The signal cable is not connected between the PC and the product, or the cable connection status is unstable. Check the signal cable.
 - Access the input menu to check the input signal.
 - The signal from the PC (Graphics card) is out of the vertical or horizontal frequency range of the product. Adjust the frequency range by referring to the specifications in this manual.
- The position of the screen is incorrect.
 - Check if the graphics card resolution and frequency are supported by the product. If the frequency exceeds the supported range, use PC settings to set the resolution to the recommended value.
- The screen is displayed abnormally.
 - Connect the signal cable that matches with the source input signal.
- Images are flickering or fluttering on the screen.
 - If you turn the monitor on when it is cold, the screen may flicker. This is normal.
 - Make sure that the current resolution and frequency settings of the graphics card are supported by the monitor.

Issues Related to Screen (Color)

- Screen has poor Color resolution (16 Colors).
 - Use PC settings to set the Color to 24 bits (True Color) or above.
- Screen Color is unstable or mono-Colored.
 - Check the connection status of the signal cable. Or, re-insert the PC graphics card.
- Black spots or bright spots appear on the screen.
 - Some pixels (red, green, blue, black) are visible on the screen due to the unique characteristics of the display panel.
This is not a malfunction of the product.
- The screen's brightness seems dark.
 - Adjust brightness and contrast again.

Issues Related to Sound

- There is no sound output.
 - Adjust the volume of the product or external device.
 - See if the sound is set properly.
- Sound is too low.
 - Adjust the volume of the product or external device.
- For some models, you will need to purchase external speakers separately since they do not have speakers built-in.

Other Issues

- The power suddenly turned off.
 - Check if the auto-off function is activated on the settings related time.
 - Power source has not being supplied properly. See if the product power cord is connected properly.
 - Check the power control settings.

OLED Image sticking

- Since after-image can occur when a specific fixed screen is used for a long time, to reduce after-images, it is recommended not to exceed the recommended daily operation time set for the screen size and to display the video content with a small number of fixed characters or logos.
Recommended daily operation time (65 inches: 12 hours)
- [Pixel Refresher]: Correct issues that may arise on the screen when it is turned on for a long period of time.
- A few horizontal lines may appear on the screens while running the [Pixel Refresher] feature. This is normal, so there is no need for concern. If the power is turned on or a power failure occurs while the [Pixel Refresher] feature is running, the feature may not work properly.
- Turn power on seven minutes after running [Pixel Refresher].
- The external speakers connected to the product may make a sound while you are running the [Pixel Refresher] feature.
- Use screen protection mode settings([TPC Auto-dimming], [Screen Shift], [Logo Luminance Adjustment], [GSR Auto-dimming], [Convex Power Control]) feature in [OLED Panel Settings] to effectively prevent the formation of an after-image.
- Using the product for a long time under the following conditions may damage the screen and leave an afterimage, so please use it with caution.
 - Specific fixed screen
 - Image adjusting screen such as Color bar
 - When activating features such as Markers, Safety area, Audio Level Meter; Waveform / Vector
 - Image with frame (including multi-view screen)
- The afterimage phenomenon occurs in the same way as other third-party OLED products. The damage mentioned above is not covered by product warranty.

PRODUCT SPECIFICATIONS

Without prior notice, all product information and specifications contained in this manual are subject to change to improve the performance of the product.

The ~ symbol means alternating current, and the symbol --- means direct current.

Item		Standard		Note		
Power Supply		120 V~ 50/60 Hz				
Input	HDMI	Maximum Resolution	4096 x 2160 @ 60 Hz		<ul style="list-style-type: none"> • HDMI Cable Length <ul style="list-style-type: none"> - 4096 x 2160 60 Hz: 3 m (9.8 ft) - 4096 x 2160 30 Hz: 10 m (32.8 ft) - 1920 x 1080 60 Hz: 15 m (49.2 ft) • Refer to the supported resolutions page for details 	
		Recommend Resolution	3840 x 2160 @ 60 Hz			
		HDCP Support	HDCP2.2 & HDCP1.4			
		Color Format & Depth	4K @ 60 / 50 Hz	RGB444 / YCbCr444, 8 bits		- 4096 x 2160 30 Hz: 10 m (32.8 ft)
	YCbCr422 12 bits			- 1920 x 1080 60 Hz: 15 m (49.2 ft)		
	4K @ 30 / 25 Hz		RGB444 / YCbCr444, 8 / 10 / 12 bits	- 4096 x 2160 30 Hz: 10 m (32.8 ft)		
		YCbCr422 12 bits	- 1920 x 1080 60 Hz: 15 m (49.2 ft)			
	SDI (4 x BNC)	Maximum Resolution	4096 x 2160 @ 60 Hz (12G Input 4Ch each)			<ul style="list-style-type: none"> • SDI Cable Length (Cable type: Belden 1694 A 4.5 C) <ul style="list-style-type: none"> - 12G (2160 p 60): 50 m (164.0 ft) - 6G (2160 p 30): 100 m (328.0 ft) - 3G (1080 p 60): 150 m (492.1 ft) - HD (1080 i 60): 250 m (820.2 ft) - SD (525 i 59.94): 300 m (984.2 ft) • Refer to the supported resolutions page for details
		Recommend Resolution	3840 x 2160 @ 60 Hz			
		Color Format & Depth	4K @ 60 / 50 Hz	YCbCr422 10 bits		
4K @ 30 / 25 Hz			RGB444 / YCbCr444, 10 / 12 bits	- 3G (1080 p 60): 150 m (492.1 ft)		
	YCbCr422 10 / 12 bits	- HD (1080 i 60): 250 m (820.2 ft)				
			- SD (525 i 59.94): 300 m (984.2 ft)			

Item		Standard		Note		
Input	SFP+	Maximum Resolution	4096 x 2160 @ 60 Hz		* Supported SFP Module: Embrix SDI SFP module	
		Recommend Resolution	3840 x 2160 @ 60 Hz			
		Color Format & Depth	4K @ 60 / 50 Hz	YCbCr422 10 bits		
			4K @ 30 / 25 Hz	RGB444 / YCbCr444, 10 / 12 bits YCbCr422 10 / 12 bits		
	USB	USB version	USB2.0, set 1 (rear)		Service (SW Update)	
	RS232C	SW update and Calibration			4P, 3.5 mm Phone Jack	
	IR	IR Receiver	0		Front TALLY part	
	Remote	RJ45, 8pin	GPI-7 Port		Remote Control via GPI (RJ-45) Port	
	LAN	RJ45, 8pin	100Base-T			
	REF	Gen Lock	Black Burst, Tri-Level			
Output	Headphone	Output type	Single Ended (L / R Stereo)		3P, 3.5 mm Phone Jack	
		Output level	Min / Typ. / Max (0.627 mV / 0.98 mV / 1.334 mV)			
	SDI (4 x BNC)	Loop Through	SDI input format to SDI output (up to 12G SDI)			
	Remote	RJ45, 8pin	GPI-7 Port		Remote Control via GPI (RJ-45) Port	
Use Environment	Operating Temperature	0 ~ 40 °C (32 °F to 104 °F)				
	Operating Humidity	10 ~ 80 %				
	Storage Temperature	-20 ~ 60 °C (-4 °F to 140 °F)				
	Storage Humidity	5 ~ 85 %				
Power Consumption	Max	470 W				
	Typ	300 W (US) 380 W (except US)			OLED Light: 35 (US), 80 (other than US)	
	Standby Mode	0.5 W				
Dimensions (Width x Height x Depth) / Weight		Head	1446.3 mm x 853.8 mm x 56.5 mm / 31 kg (56.9 inches x 33.6 inches x 2.2 inches / 68.3 lbs)			
		Stand	430 mm x 150.2 mm x 272.0 mm / 4 kg (16.9 inches x 5.9 inches x 10.7 inches / 8.8 lbs)			
		Head + Stand	1446.3 mm x 896.5 mm x 272.0 mm / 35 kg (56.9 inches x 35.2 inches x 10.7 inches / 77.1 lbs)			

SDI Support mode

Interfaces		Signal Format	
12G Single Link 4K (ST 2082-10)	3840 x 2160 4096 x 2160	YCbCr 4:2:2 10 bit	47.95 / 48 / 50 / 59.94 / 60 p
		YCbCr 4:2:2 12 bit	23.98 / 24 / 25 / 29.97 / 30 p
		YCbCr 4:4:4 10 bit	
		YCbCr 4:4:4 12 bit	
		RGB 4:4:4 10 bit	
		RGB 4:4:4 12 bit	
6G Single Link 4K (ST 2081-10)	3840 x 2160 4096 x 2160	YCbCr 4:2:2 10 bit	23.98 / 24 / 25 / 29.97 / 30 p
Quad Link 3G_A/B 4K 2-Sample Interleave (ST 425-5)	3840 x 2160 4096 x 2160	YCbCr 4:2:2 10 bit	47.95 / 48 / 50 / 59.94 / 60 p
		YCbCr 4:2:2 12 bit	23.98 / 24 / 25 / 29.97 / 30 p
		YCbCr 4:4:4 10 bit	
		YCbCr 4:4:4 12 bit	
		RGB 4:4:4 10 bit	
		RGB 4:4:4 12 bit	
Quad Link 3G_A/B 4K Square (ST 425-5)	3840 x 2160 4096 x 2160	YCbCr 4:2:2 10 bit	47.95 / 48 / 50 / 59.94 / 60 p
		YCbCr 4:2:2 12 bit	23.98 / 24 / 25 / 29.97 / 30 p
		YCbCr 4:4:4 10 bit	
		YCbCr 4:4:4 12 bit	
		RGB 4:4:4 10 bit	
		RGB 4:4:4 12 bit	
Quad Link HD 4K Square (ST 425-3)	3840 x 2160 4096 x 2160	YCbCr 4:2:2 10 bit	23.98 / 24 / 25 / 29.97 / 30 p ¹⁾
Dual Link 3G 4K Square (ST 425-3)	3840 x 2160 4096 x 2160	YCbCr 4:2:2 10 bit	23.98 / 24 / 25 / 29.97 / 30 p (supported in SDI1 & SDI2 only)
Dual Link 3G_B 4K 2-Sample Interleave (ST 425-3)	3840 x 2160 4096 x 2160	YCbCr 4:2:2 10 bit	23.98 / 24 / 25 / 29.97 / 30 p
Dual Link 3G_A/B (ST 425-3)	1920 x 1080 2048 x 1080	YCbCr 4:2:2 12 bit	47.95 / 48 / 50 / 59.94 / 60 p
		YCbCr 4:4:4 10 bit	
		YCbCr 4:4:4 12 bit	
		RGB 4:4:4 10 bit	
		RGB 4:4:4 12 bit	

1) PsF (Progressive Segmented Frames) supported.

Interfaces	Signal Format			
3G_B Dual Link (ST 425-1)	1920 x 1080 2048 x 1080	YCbCr 4:2:2 10 bit	47.95 / 48 / 50 / 59.94 / 60 p	
		YCbCr 4:2:2 12 bit	23.98 / 24 / 25 / 29.97 / 30 p ¹⁾ 50 / 59.94 / 60 i	
		YCbCr 4:4:4 10 bit		
		YCbCr 4:4:4 12 bit		
		RGB 4:4:4 10 bit		
		RGB 4:4:4 12 bit		
3G_A Single Link (ST 425-1)	1280 x 720	YCbCr 4:4:4 10 bit	23.98 / 24 / 25 / 29.97 / 30 / 50 / 59.94 / 60 p	
		RGB 4:4:4 10 bit		
	1920 x 1080 2048 x 1080	YCbCr 4:2:2 10 bit	47.95 / 48 / 50 / 59.94 / 60 p	
		YCbCr 4:2:2 12 bit		
		YCbCr 4:4:4 10 bit		23.98 / 24 / 25 / 29.97 / 30 p ¹⁾ 50 / 59.94 / 60 i
		YCbCr 4:4:4 12 bit		
		RGB 4:4:4 10 bit		
		RGB 4:4:4 12 bit		
Dual Link HD (ST 372)	1920 x 1080 2048 x 1080	YCbCr 4:2:2 10 bit	47.95 / 48 / 50 / 59.94 / 60 p	
		YCbCr 4:2:2 12 bit	23.98 / 24 / 25 / 29.97 / 30 p ¹⁾ 50 / 59.94 / 60 i	
		YCbCr 4:4:4 10 bit		
		YCbCr 4:4:4 12 bit		
		RGB 4:4:4 10 bit		
		RGB 4:4:4 12 bit		
HD Single Link (ST 292)	1280 x 720	YCbCr 4:2:2 10 bit	23.98 / 24 / 25 / 29.97 / 30 / 50 / 59.94 / 60 p	
	1920 x 1080 2048 x 1080		23.98 / 24 / 25 / 29.97 / 30 p ¹⁾ 50 / 59.94 / 60 i	
SD Single Link (ST 259)	720 x 480	YCbCr 4:2:2 10 bit	59.94 i	
	720 x 576	YCbCr 4:2:2 10 bit	50 i	

1) PsF (Progressive Segmented Frames) supported.

SFP+ Support mode

Interfaces		Signal Format	
12G Single Link 4K (ST 2082-10)	3840 x 2160 4096 x 2160	YCbCr 4:2:2 10 bit	47.95 / 48 / 50 / 59.94 / 60 p
		YCbCr 4:2:2 12 bit	23.98 / 24 / 25 / 29.97 / 30 p
		YCbCr 4:4:4 10 bit	
		YCbCr 4:4:4 12 bit	
		RGB 4:4:4 10 bit	
		RGB 4:4:4 12 bit	
6G Single Link 4K (ST 2081-10)	3840 x 2160 4096 x 2160	YCbCr 4:2:2 10 bit	23.98 / 24 / 25 / 29.97 / 30 p
3G_A Single Link (ST 425-1)	1280 x 720	YCbCr 4:4:4 10 bit	23.98 / 24 / 25 / 29.97 / 30 / 50 / 59.94 / 60 p
		RGB 4:4:4 10 bit	
	1920 x 1080 2048 x 1080	YCbCr 4:2:2 10 bit	47.95 / 48 / 50 / 59.94 / 60 p
		YCbCr 4:2:2 12 bit	23.98 / 24 / 25 / 29.97 / 30 p ¹⁾ 50 / 59.94 / 60 i
		YCbCr 4:4:4 10 bit	
		YCbCr 4:4:4 12 bit	
		RGB 4:4:4 10 bit	
		RGB 4:4:4 12 bit	
HD Single Link (ST 292)	1280 x 720	YCbCr 4:2:2 10 bit	23.98 / 24 / 25 / 29.97 / 30 / 50 / 59.94 / 60 p
	1920 x 1080 2048 x 1080		23.98 / 24 / 25 / 29.97 / 30 p ¹⁾ 50 / 59.94 / 60 i
SD Single Link (ST 259)	720 x 480	YCbCr 4:2:2 10 bit	59.94 i
	720 x 576	YCbCr 4:2:2 10 bit	50 i

1) PsF (Progressive Segmented Frames) supported.

Quad View Support mode

Interfaces	Signal Format		
12G Single Link 4K (ST 2082-10)	3840 x 2160 4096 x 2160	YCbCr 4:2:2 10 bit	47.95 / 48 / 50 / 59.94 / 60 p
		YCbCr 4:2:2 12 bit	23.98 / 24 / 25 / 29.97 / 30 p
		YCbCr 4:4:4 10 bit	
		YCbCr 4:4:4 12 bit	
		RGB 4:4:4 10 bit	
		RGB 4:4:4 12 bit	
6G Single Link 4K (ST 2081-10)	3840 x 2160 4096 x 2160	YCbCr 4:2:2 10 bit	23.98 / 24 / 25 / 29.97 / 30 p
3G_A Single Link (ST 425-1)	1920 x 1080 2048 x 1080	YCbCr 4:2:2 10 bit	47.95 / 48 / 50 / 59.94 / 60 p
		YCbCr 4:2:2 12 bit	23.98 / 24 / 25 / 29.97 / 30 p
		YCbCr 4:4:4 10 bit	
		YCbCr 4:4:4 12 bit	
		RGB 4:4:4 10bit	
		RGB 4:4:4 12bit	
HD Single Link (ST 292)	1920 x 1080 2048 x 1080	YCbCr 4:2:2 10 bit	23.98 / 24 / 25 / 29.97 / 30 p

* Support only at all same resolutions in each SDI inputs for Quad View.

* Quad Link only supports Progressive resolution.

HDMI Support Mode

Signal Format		
640 x 480 720 x 480 800 x 600 1024 x 768 1280 x 720	RGB 4:4:4 8 / 10 / 12 bit	60 p
	YCbCr 4:4:4 8 / 10 / 12 bit	
	YCbCr 4:2:2 12 bit	
720 x 576 1280 x 720	RGB 4:4:4 8 / 10 / 12 bit	50 p
	YCbCr 4:4:4 8 / 10 / 12 bit	
	YCbCr 4:2:2 12 bit	
1920 x 1080	RGB 4:4:4 8 / 10 / 12 bit	24 / 25 / 30 / 50 / 60 p 50 / 60 i
	YCbCr 4:4:4 8 / 10 / 12 bit	
	YCbCr 4:2:2 12 bit	
2048 x 1080	RGB 4:4:4 8 / 10 / 12 bit	24 / 25 / 30 / 48 / 50 / 60 p 50 / 60 i
	YCbCr 4:4:4 8 / 10 / 12 bit	
	YCbCr 4:2:2 12 bit	
3840 x 2160 4096 x 2160	RGB 4:4:4 8 / 10 / 12 bit	24 / 25 / 30 p
	YCbCr 4:4:4 8 / 10 / 12 bit	
	YCbCr 4:2:2 12 bit	
	RGB 4:4:4 8 bit	50 / 60 p
	YCbCr 4:4:4 8 bit	
	YCbCr 4:2:2 12 bit	
	YCbCr 4:2:0 8 bit	

LICENSES

Supported licenses may differ by model. For more information of the licenses, visit www.lg.com.



The terms HDMI, HDMI High-Definition Multimedia Interface, HDMI trade dress and the HDMI Logos are trademarks or registered trademarks of HDMI Licensing Administrator, Inc.

Manufactured under license from Dolby Laboratories. Dolby, Dolby Vision, Dolby Vision IQ, Dolby Audio, Dolby Atmos, and the double-D symbol are trademarks of Dolby Laboratories Licensing Corporation.



Open Source Software Notice Information

To obtain the source code that is contained in this product, under GPL, LGPL, MPL, and other open source licenses that have the obligation to disclose source code, and to access all referred license terms, copyright notices and other relevant documents, please visit <https://opensource.lge.com>.

LG Electronics will also provide open source code to you on CD-ROM for a charge covering the cost of performing such distribution (such as the cost of media, shipping, and handling) upon email request to opensource@lge.com.

This offer is valid to anyone in receipt of this information for a period of three years after our last shipment of this product.



The model and serial number of the product are located on the back and on one side of the product. Record them below in case you ever need service.

MODEL _____

SERIAL NO. _____

Temporary noise is normal when powering ON or OFF this device.