



OWNER'S MANUAL

HIGH POWER SPEAKER SYSTEM

Please read this manual carefully before operating your set and retain it for future reference.

MODEL
FJ7



Safety Information



CAUTION
RISK OF ELECTRIC SHOCK
DO NOT OPEN



CAUTION: TO REDUCE THE RISK OF ELECTRIC SHOCK DO NOT REMOVE COVER (OR BACK) NO USER-SERVICEABLE PARTS INSIDE REFER SERVICING TO QUALIFIED SERVICE PERSONNEL



This lightning flash with arrowhead symbol within an equilateral triangle is intended to alert the user to the presence of uninsulated dangerous voltage within the product's enclosure that may be of sufficient magnitude to constitute a risk of electric shock to persons.



The exclamation point within an equilateral triangle is intended to alert the user to the presence of important operating and maintenance (servicing) instructions in the literature accompanying the product.

WARNING: TO PREVENT FIRE OR ELECTRIC SHOCK HAZARD, DO NOT EXPOSE THIS PRODUCT TO RAIN OR MOISTURE.

CAUTION: The apparatus should not be exposed to water (dripping or splashing) and no objects filled with liquids, such as vases, should be placed on the apparatus.

WARNING: Do not install this equipment in a confined space such as a book case or similar unit.

CAUTION: Do not use high voltage products around this product. (ex. Electrical swatter) This product may malfunction due to electrical shock.

CAUTION: Do not block any ventilation openings. Install in accordance with the manufacturer's instructions.

Slots and openings in the cabinet are provided for ventilation and to ensure reliable operation of the product and to protect it from over heating. The openings shall be never be blocked by placing the product on a bed, sofa, rug or other similar surface. This product should not be placed in a built-in installation such as a bookcase or rack unless proper ventilation is provided or the manufacturer's instruction has been adhered to.

NOTICE: For safety marking information including product identification and supply ratings, please refer to the main label on the bottom or the other surface of the product.

CAUTION concerning the Power Cord

The Power Plug is the disconnecting device. In case of an emergency, the Power Plug must remain readily accessible.

Check the specification page of this owner's manual to be certain of the current requirements.

Do not overload wall outlets. Overloaded wall outlets, loose or damaged wall outlets, extension cords, frayed power cords, or damaged or cracked wire insulation are dangerous. Any of these conditions could result in electric shock or fire. Periodically examine the cord of your device, and if its appearance indicates damage or deterioration, unplug it, discontinue use of the device, and have the cord replaced with an exact replacement part by an authorized service center. Protect the power cord from physical or mechanical abuse, such as being twisted, kinked, pinched, closed in a door, or walked upon. Pay particular attention to plugs, wall outlets, and the point where the cord exits the device.

This device is equipped with a portable battery or accumulator.

Safety way to remove the battery or the battery from the equipment: Remove the old battery or battery pack, follow the steps in reverse order than the assembly. To prevent contamination of the environment and bring on possible threat to human and animal health, the old battery or the battery put it in the appropriate container at designated collection points. Do not dispose of batteries or battery together with other waste. It is recommended that you use local, free reimbursement systems batteries and accumulators. The battery shall not be exposed to excessive heat such as sunshine, fire or the like.

CAUTION: No naked flame sources, such as lighted candles, should be placed on the apparatus.

Symbols

~	Refers to alternating current(AC).
≡	Refers to direct current(DC).
⊞	Refers to class II equipment.
⏻	Refers to stand-by.
I	Refers to "ON" (power).
⚡	Refers to dangerous voltage.

Table of Contents

1 Getting Started

- 2 Safety Information
- 6 Unique Features
- 7 Playable file Requirement
 - 7 – Music file requirement
 - 7 – Compatible USB Devices
 - 7 – USB device requirement
- 8 Rear panel
- 10 Carrying the unit

2 Connecting

- 11 Use of Tripod
- 13 AC Power Cord Connection
- 13 Optional Equipment Connection
 - 13 – AUX IN Connection
 - 13 – AUX OUT Connection
 - 14 – PARTY LINK
 - 14 – PORT IN Connection
- 15 – Listening to music from your portable player or external device
- 15 – USB Connection

3 Operating

- 16 Basic Operations
 - 16 – USB Operations
 - 17 – AUTO DJ
 - 17 Using BLUETOOTH® wireless technology
 - 18 – Listening to music stored on the Bluetooth devices
 - 20 Using the Music Flow Bluetooth App
 - 20 – About “Music Flow Bluetooth” App
 - 20 – Install “Music Flow Bluetooth” App onto Your Bluetooth Device
 - 21 – Activate Bluetooth with “Music Flow Bluetooth” App
 - 22 Radio Operations
 - 22 – Listening to the radio
 - 22 – Presetting the Radio Stations
 - 22 – Deleting all the saved stations
 - 23 Sound adjustment
 - 23 – Setting the sound mode
 - 23 – Setting the USER EQ
 - 24 Other Operations
 - 24 – DEMO
 - 24 – Using Microphone
 - 26 – Auto power down
 - 27 – AUTO POWER On
 - 27 – Auto function change
 - 28 LG Sound Sync
 - 29 WIRELESS PARTY LINK Connection

4 Troubleshooting

- 30 Troubleshooting
- 30 – General

5 Appendix

- 31 General specifications
- 32 Trademarks and Licenses
- 32 Maintenance
- 32 – Handling the Unit

1

2

3

4

5

Unique Features

1

Getting Started

BLUETOOTH®

Listens to music stored on your **Bluetooth** device.

Portable In

Listens to music from your portable device. (MP3, Notebook, etc.)

AUTO DJ

Blends the end of one song into the beginning of another for seamless playback.

Carrying the unit

The unit has wheels and a handle so you can easily move the unit.

Music Flow Bluetooth

Music Flow Bluetooth is an app designed to let you take control of some of LG's latest audio devices. (Page 20)

LG Sound Sync

Controls volume level of this unit by the remote control of your LG TV that is compatible with LG Sound Sync.

Playable file Requirement

Music file requirement

MP3/WMA file compatibility with this unit is limited as follows.

- Sampling frequency : within 32 to 48 kHz (MP3), within 32 to 48 kHz (WMA)
- Bit rate : within 32 to 320 kbps (MP3), 40 to 192 kbps (WMA)
- Maximum files : USB : 2,000
- Maximum folders : USB : 200
- File extensions : ".mp3"/ ".wma"
- Certain MP3/WMA files may not be played depending on the type or format of the file.

Compatible USB Devices

- MP3 Player : Flash type MP3 player.
- USB Flash Drive :
Devices that support USB2.0 or USB1.1.
- The USB function of this unit does not support all USB devices.

USB device requirement

- Devices which require additional program installation when you have connected it to a computer, are not supported.
- Do not extract the USB device while in operation.
- For a large capacity USB, it may take longer than a few minute to be searched.
- To prevent data loss, back up all data.
- If you use a USB extension cable or USB hub, the USB device is not recognized.
- Using NTFS file system is not supported. (Only FAT(16/ 32) file system is supported.)
- This unit recognizes up to 2,000 files.
- External HDD, Card readers, Locked devices, or hard type USB devices are not supported.
- USB port of the unit cannot be connected to PC. The unit cannot be used as a storage device.
- Some USB may not work with this unit.

Rear panel

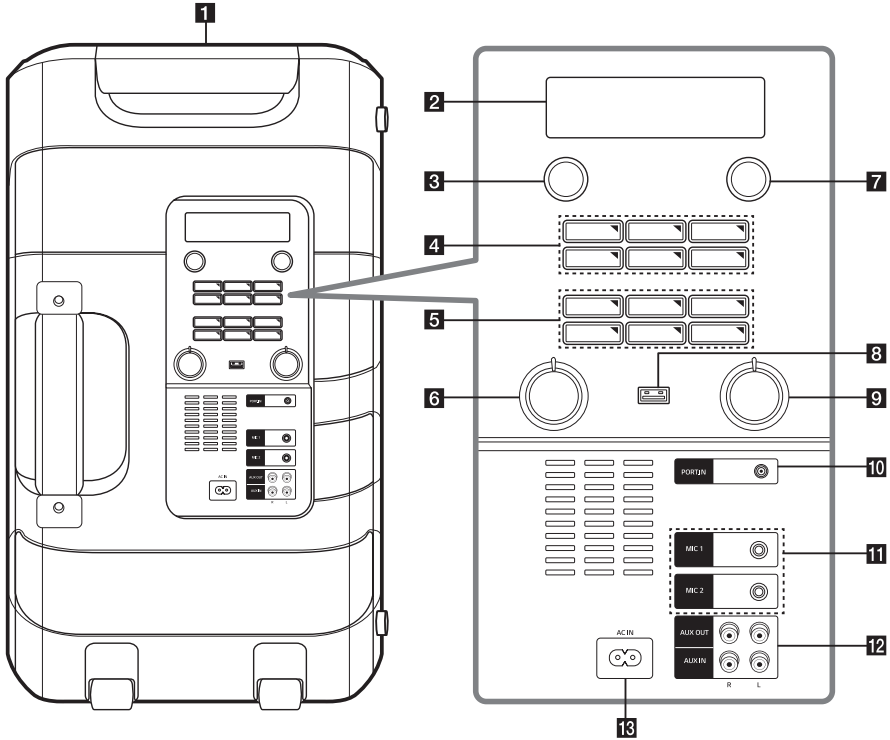

- 1** Handle
- 2** Display window
- 3** ⏻ (Standby)
Turns the power on or off.
- 4** **PRESET/DEMO**
 - Press and hold to store radio stations. (Page 22)
 - Chooses a preset number for a radio station.
 - In power off status, if you press **PRESET/DEMO**, show demo mode.
- AUTO DJ/PRESET DELETE**
 - Selects the AUTO DJ mode. (Page 17)
 - Press and hold to delete all the saved stations. (Page 22)
 - Sees the name of connected all **Bluetooth** device in **Bluetooth** mode.

WIRELESS LINK

- Selects MASTER or SLAVE on WIRELESS PARTY LINK mode.
- Enable or disable WIRELESS PARTY LINK mode.
- ⏮** (Skip/Search)
 - Skips backward.
 - Searches for a section within a file.
 - Selects the radio stations.
- ⏸** (Play/Pause)
 - Starts or pauses playback.
- ⏭** (Skip/Search)
 - Skips forward.
 - Searches for a section within a file.
 - Selects the radio stations.

5 USER EQ/PARTY LINK

- Selects the sound effect created by your own. (Page 23)
- Press and hold to select PARTY LINK.

SOUND EFFECT/BASS BLAST

- Chooses sound impressions.
- Press and hold to select BASS effect directly.

VOICE CANCELLER

You can enjoy the function while playing the music, by reducing singer vocal of music in the various source.

ECHO

Selects ECHO mode.

KEY CHANGER

Press to change the key to suit your vocal range.

VOCAL EFFECTS

Selects VOCAL EFFECTS mode.

6 MIC VOLUME/LEVEL CONTROL

- Adjust microphone volume.
- Turns clockwise or counterclockwise to control the USER EQ level.
- Adjust KEY CHANGER level.
- Sets Delay value in PARTY LINK mode.

7 F (Function)

Selects the function and input source.

Input source / Function	Display
USB	USB
AUX input	AUX
Portable input	PORTABLE
Bluetooth	BT
LG Sound Sync (Wireless)	LG TV
Radio	FM

8 USB Port

You can play sound files by connecting the USB device.

9 MASTER VOLUME

Adjust speaker volume.

10 PORT. (Portable) IN jack**11 MIC (Microphone) 1/2 jack****12 AUX OUT (L/R)****AUX IN (L/R)**

Connect an auxiliary device.

13 AC IN socket

Carrying the unit

The unit has wheels and a handle so you can easily move the unit.

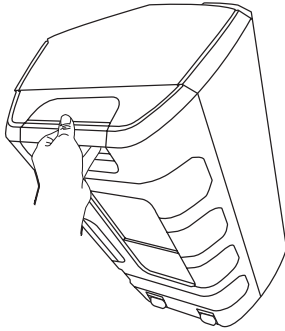

Caution

- Do not draw the unit on the unpaved road or the stair.
- Be careful it does not drop the unit when you carry it.
- Carry the unit, after then disconnect the connected cables.
- Do not step or sit on the unit. Otherwise this unit may fall down and causing personal injury.
- Do not place the unit on an unstable position and place the unit at a safe distance from the child's reach.
- Be careful that the unit should not fall down. Otherwise it may result in malfunction and causing personal injury and/ or property damage.

Use of Tripod

You can mount the unit on a tripod.
The tripod is an optional purchase.

! Caution

- Extend the tripod legs as much as possible and tighten up the screw securely.
- Before connecting with the unit, you must set up the tripod completely to prevent shaking.

1. Unfold the tripod on a flat surface. And then fix the tripod.
Tighten up the tightening part of the tripod.
2. Lift the speaker and connect the tripod to fixing part on the bottom of the speaker.

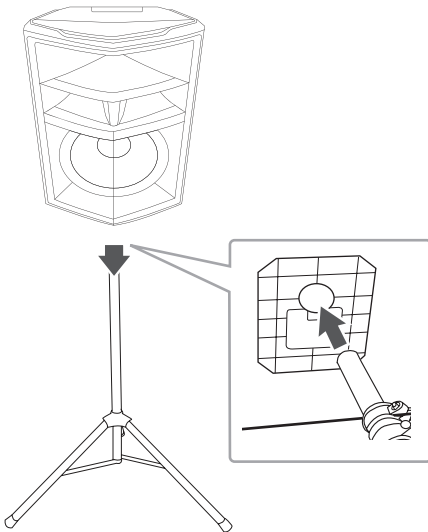

! Caution

You should work together with two or more people when connecting the speaker and the tripod.

3. Tighten up the Hand screw on the bottom of the unit.

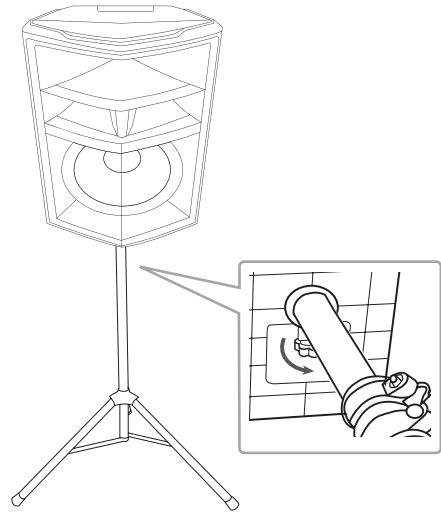

! Caution

Tighten up the Hand screw on the bottom of the unit while the other is holding a speaker and tripod.

! Note

- If you use a tripod, use the tripod only for speaker.
- Before buying a tripod, check the specifications for maximum bearing load of the center column.
(Unit's net weight : about 18.5 kg)

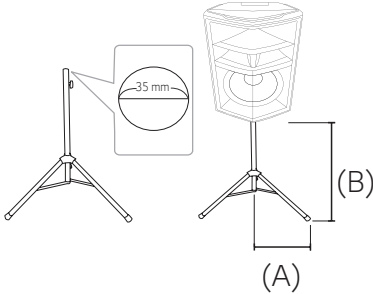

- Use tripod as below :
(A) From tripod's center to tripod's leg : above 600 mm
(B) From top of tripod to bottom of tripod : below 900 mm
(C) Tripod net weight : over 3.9 kg
- Use a tripod as low as possible for safety use.
- You should pull the center column to the maximum only in case of need.
- Mount only one unit on each tripod.
- Do not try to extend the tripod legs outside over its allowed range.
- Make sure the tripod is correctly assembled and all its components are tightly connected.
- Do not try to assemble the tripod if parts are missing or defective.
- After installation, check whether the unit is set up firmly on the tripod or not.
- Do not place the unit on an unstable position where it might accidentally fall over.
- Add weight such as sand bags around the tripod legs to prevent them from falling over.

! Note

- You should limit people around the unit while using this unit with tripod. Otherwise it may result in malfunction and causing personal injury or property damage.
- Standing on the stool to reach unit control panel is risky and might lead to injuries.
- Do not put or attach other objects on the tripod.
- Do not shake or push the unit when the tripod is installed.
- Refrain from moving around the tripod after unit is installed.
- Remove the units from all connected cables of the tripods before moving the tripods or adjusting their height.
- When transporting or moving the unit, always use two or more people.
- When you use the tripod, use an extension cord. Always be careful the movement of cable.
- It is prohibited to use this unit outside. (Indoor use only)
- Do not expose the unit to excessive dust or vibrations, or extreme cold or heat (such as in direct sunlight, near a heater) to prevent the possibility of panel disfiguration or damage to the internal components.
- When using the external input cable (Mic, etc.) after installing the unit on the tripod, external input cable can cause the unit to fall down.
- Watch out the people can trip over the input cable (Mic, etc.) connected the unit.
- Always be careful of the unit being tripped.

AC Power Cord Connection

1. Connect one end of the AC power cord (included) to the AC IN socket.

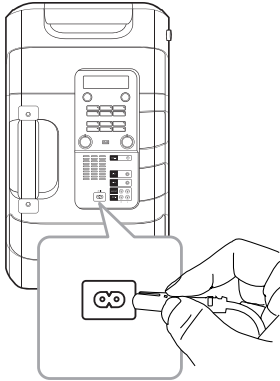

2. Plug the other end into the wall outlet.

! Note

Unplug the AC power cord from the wall outlet if you do not use for an extended period of time.

Optional Equipment Connection

AUX IN Connection

Connect an output of auxiliary device (Camcorder, TV, Player, etc) to the **AUX IN** (L/R) connector.

If your device has only one output for audio (mono), connect it to the left (white) audio jack on the unit.

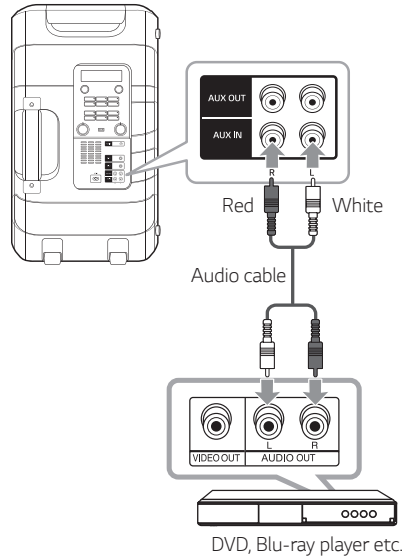

AUX OUT Connection

Connect an input of auxiliary device to the **AUX OUT** (L/R) connector.

If your device has only one input for audio (mono), connect it to the left (white) audio jack on the unit.

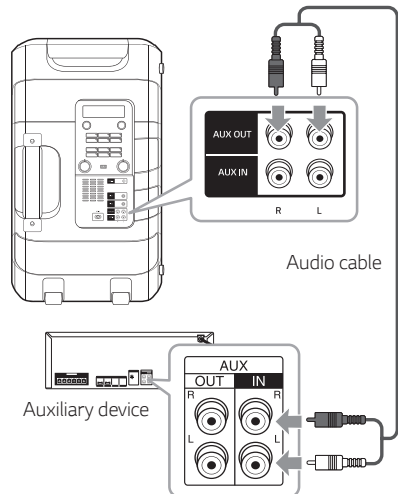

PARTY LINK

You can connect two units to play music together.

The name of function about sound expansion between the compatible products wired or wirelessly was changed to PARTY LINK or WIRELESS PARTY LINK.

1. Connect **AUX OUT** connector on a unit to the **AUX IN** connector on the other unit using Audio cable.
2. Press and hold **USER EQ/PARTY LINK** on the unit for 3 seconds connected through AUX OUT and then select LINK ON.
"LINK ON" appears in the display window and change to "DELAY time" soon.
3. Rotate **MIC VOLUME/LEVEL CONTROL** on the unit to adjust Delay setting.
When "LINK ON" and "DELAY time" are displayed in the display window, you can adjust the delay time.
4. Press **USER EQ/PARTY LINK** on the unit to save the Delay setting.

! Note

- This function is available in all functions. (Except LG TV function)
- The initial Delay is 30 ms. If you want to change the Delay time, rotate **MIC VOLUME/LEVEL CONTROL** on the unit.
The connected device's Delay may differ. If Audio Sync is not matched, adjust Delay of PARTY LINK to synchronize sound.
- It is available to adjust the Delay from 0 ms to 200 ms. Synchronizing tempo is not available depending on devices.
- Delay value is saved and PARTY LINK is turned off when the unit turns off.
- You can select LINK ON/LINK OFF mode by pressing and holding **USER EQ/PARTY LINK** on the unit for 3 seconds on the unit.
- In case of the microphone, delay setting is not applied.

PORT. IN Connection

Connect an output (earphone or line out) of portable device (MP3 or PMP etc) to the **PORT. IN** (3.5 mm) connector.

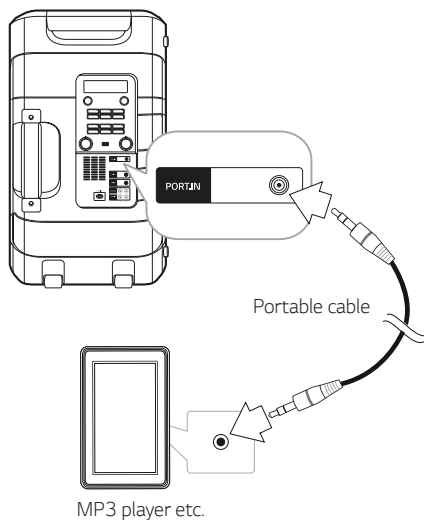

Listening to music from your portable player or external device

The unit can be used to play the music from many types of portable player or external device.

1. Connect the portable player to the **PORT. IN** connector of the unit.

Or

Connect the external device to the **AUX IN** connector of the unit.

2. Turn the power on by pressing  on the unit.
3. Press **F** on the unit to select AUX or PORTABLE function.
4. Turn on the portable player or external device and start it playing.

Note

Automatically switches to the PORTABLE function when you connect the portable device to the **PORT. IN** connector.

USB Connection

Connect a USB device (or MP3 player, etc.) to the USB ports on the unit.

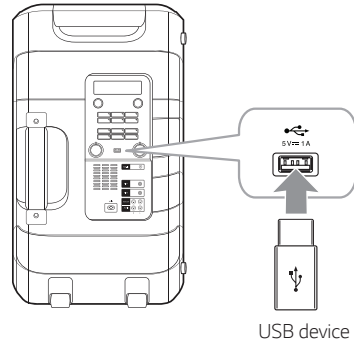

Note

Removing the USB device from the unit :

1. Choose a different function.
2. Remove the USB device from the unit.

Basic Operations

USB Operations

1. Connect the USB device to the USB port.
2. Select USB function by pressing **F** on the unit.

To	Do this
Playback	Press > on the unit.
Pause	Press > on the unit during playback.
Searching for a section within a file	Press and hold <</>> on the unit during playback and release it at the point you want to listen to.
Skipping to the next/previous file	<p>- During playback,</p> <p>Press >> on the unit to go to the next file.</p> <p>Playing less than 2 seconds, press << on the unit to go to the previous file.</p> <p>Playing after 3 seconds, press <<< on the unit to go to the beginning of the file.</p>

Note

- Even after restarting the unit or switching one function to another, you can listen to music from the point where it's last been played.
- The resume point may be cleared when in the cases below
 - Removing the USB device from the unit.

AUTO DJ

Auto DJ blends the end of one song into the beginning of another for seamless playback. It equalizes volume across files for uninterrupted playback.

Press **AUTO DJ/PRESET DELETE** on the unit repeatedly, the display changes as follows.

AUTO DJ RANDOM → AUTO DJ SEQUENTIAL → AUTO DJ OFF

Mode	Display Window	Description
OFF	AUTO DJ OFF	-
RANDOM	AUTO DJ RANDOM	The music is played randomly on this mode.
REPEAT	AUTO DJ SEQUENTIAL	The music is played repeatedly on this mode.

! Note

- AUTO DJ mode does not support searching for a section within a file.
- AUTO DJ is not supported in the music file whose length is less than 60 seconds.
- If you move to other functions, AUTO DJ will be disabled.

Using BLUETOOTH® wireless technology

About Bluetooth

Bluetooth is wireless communication technology for short range connection.

The sound may be interrupted when the connection interfered by the other electronic wave or you connect the **Bluetooth** in the other rooms.

Connecting individual devices under **Bluetooth** wireless technology does not incur any charges. A mobile phone with **Bluetooth** wireless technology can be operated via the Cascade if the connection was made via **Bluetooth** wireless technology.

- Available Devices : Smart phone, MP3, Notebook, etc.
- Version : 4.0
- Codec : SBC

Bluetooth Profiles

In order to use **Bluetooth** wireless technology, devices must be able to interpret certain profiles. This unit is compatible with following profile.

A2DP (Advanced Audio Distribution Profile)

Listening to music stored on the Bluetooth devices

Pairing your unit and Bluetooth device

Before you start the pairing procedure, make sure the **Bluetooth** feature is activated on your **Bluetooth** device. Refer to your **Bluetooth** device's user guide. Once a pairing operation is performed, it does not need to be performed again.

1. Turn on the unit.

! Note

When Bluetooth connection lock is activated, you can search **Bluetooth** device in BT function.

2. Operate the **Bluetooth** device and perform the pairing operation. When searching for this unit with the **Bluetooth** device, a list of the devices found may appear in the **Bluetooth** device display depending on the type of **Bluetooth** device. Your unit appears as "LG FJ7 (XX)".

! Note

- Sees **Bluetooth** device name of the unit every 10 seconds in BT READY.
- XX means the last two digits of **Bluetooth** address. For example, if your unit has a **Bluetooth** address such as 9C:02:98:4A:F7:08, you will see "LG FJ7 (08)" on your **Bluetooth** device.
- Depending on the **Bluetooth** device type, some devices may have a different pairing process. Enter the PIN code (0000) as needed.
- You can connect this unit with up to 3 **Bluetooth** devices simultaneously using the same method as described above, only in the **Bluetooth** function.
- The multi pairing connection is only supported on Android devices. (Multi pairing connection may not be supported depending on the connected device specifications.)
- Removable/detachable **Bluetooth** devices (Ex: Dongle etc.) will not support multi pairing.

3. When this unit is successfully connected with your **Bluetooth** device, "PAIRED" appears on the display window and change to **Bluetooth** device name soon. Then "BT" will appear on the display window.

! Note

- "PAIRED" will momentarily appear on the display when you connect other devices for multi pairing.
- If the device name is unavailable, "_ " will be displayed.

4. Listen to music.

To play a music stored on your **Bluetooth** device, refer to your **Bluetooth** device's user guide.

! Note

- When using **Bluetooth** technology, you have to make a connection between the unit and the **Bluetooth** device as close as possible and keep the distance. However, it may not work well in certain situations as described below :
 - There is an obstacle between the unit and the **Bluetooth** device.
 - There is an device using same frequency with **Bluetooth** technology such as a medical equipment, a microwave or a wireless LAN device.
- You should connect your **Bluetooth** device to this unit again when you restart it.
- Even if this unit connected up to 3 **Bluetooth** devices in the **Bluetooth** mode, you can play and control music by using only one of the connected devices.

Controls connected Bluetooth device

You can control connected **Bluetooth** device by the unit; play, pause, skip.

! Note

- Only Android OS and iOS is available to use this function.
- This function may not be supported depending on the **Bluetooth** device, or operated differently.

Bluetooth connection lock (BT LOCK)

You can limit **Bluetooth** connection to only BT (**Bluetooth**) and LG TV function to prevent unintended **Bluetooth** connection.

To turn on this function, press and hold **>||** on the unit for about 5 seconds in BT (**Bluetooth**) function. "BT LOCK" appears then you can limit **Bluetooth** connection.

To turn off this function, press and hold **>||** on the unit for about 5 seconds in BT (**Bluetooth**) function. "BT UNLOCK" appears.

! Note

- The sound may be interrupted when the connection has interference from other electronic devices.
- Depending on the type of the device, you may not be able to use the **Bluetooth** function.
- You can enjoy wireless system using phone, MP3, Notebook, etc.
- The more distance between the unit and the **Bluetooth** device, the lower the sound quality becomes.
- **Bluetooth** connection will be disconnected when the unit is turned off or the **Bluetooth** device gets far from the unit.
- When **Bluetooth** connection is disconnected, connect the **Bluetooth** device to the unit again.
- When a **Bluetooth** device is not connected, "BT READY" appears on the display window.
- When you use the **Bluetooth** function, adjust the volume to a proper level on the **Bluetooth** device.
- If a **Bluetooth** device is connected when using LG TV, LG TV is disconnected and the **Bluetooth** device is connected.
- When you connect **Bluetooth** device (iOS device etc.) to this unit or operate the device, the volume level can be synchronized with each other.
- **Bluetooth** connection will be disconnected when you change the **Bluetooth** function to the others. In "Music Flow Bluetooth" app connection, only one device which you are playing keeps **Bluetooth** connection. You can control the **Bluetooth** device with this unit but you cannot use sound output.
- When entering **Bluetooth** function, this unit automatically connect to **Bluetooth** device which is connected the last. (Auto connection may not be supported depending on the connected device specifications.)

Using the Music Flow Bluetooth App

! Note

- Only Android OS is available to use “Music Flow Bluetooth” app with this unit.
- It is recommended to use the latest version of app.

About “Music Flow Bluetooth” App

“Music Flow Bluetooth” app brings a suite of new features to this unit.

To enjoy more features, you are recommended to download and install free “Music Flow Bluetooth” app.

Here is introduce a few of the many features of “Music Flow Bluetooth” app.

Multi Juke box : Your entertainment increases three fold when you connect up to 3 **Bluetooth** phones at the same time. Play music from all three phone and create a customized playlist from all the phones.

Install “Music Flow Bluetooth” App onto Your Bluetooth Device

There are two ways to install “Music Flow Bluetooth” app onto your **Bluetooth** device.

Install “Music Flow Bluetooth” App through QR code

1. Install “Music Flow Bluetooth” app through QR code. Use the scanning software to scan the QR code.



2. Tap an icon for installation.

! Note

- Make sure that your **Bluetooth** device is connected to the Internet.
- Make sure that your **Bluetooth** device has a scanning software application. If you don't have one, download one from “Google Android Market (Google Play Store)”.
- Depending on the area, QR code may not work.

Install “Music Flow Bluetooth” App through “Google Android Market (Google Play Store)”

1. Tap the “Google Android Market (Google Play Store)” icon.
2. In the search bar, type in the “Music Flow Bluetooth” and search it.
3. In the search result list, find and tap “Music Flow Bluetooth” to start downloading **Bluetooth** app.
4. Tap an icon for installation.
5. Tap an icon for downloading.

! Note

- Make sure that your **Bluetooth** device is connected to the Internet.
- Make sure that your **Bluetooth** device is equipped with “Google Android Market (Google Play Store)”.

Activate Bluetooth with “Music Flow Bluetooth” App

“Music Flow Bluetooth” app helps to connect your **Bluetooth** device to this unit.

1. Tap “Music Flow Bluetooth” app icon on the home screen to open “Music Flow Bluetooth” app, and go to the main menu.
2. If you want to get more information to operate, tap [Setting] and tap [Help] menu.

! Note

- “Music Flow Bluetooth” app will be available in the software version as follow;
 - Android O/S : Ver 4.0.3 (or later)
- Depending on the **Bluetooth** device, “Music Flow Bluetooth” app may not work.
- After connection of “Music Flow Bluetooth” app, music may be output from your device. In this case, try connecting procedure again.
- If you operate the other applications or change the settings on your **Bluetooth** device while using “Music Flow Bluetooth” app, “Music Flow Bluetooth” app may operate abnormally.
- When “Music Flow Bluetooth” app operates abnormally, check your **Bluetooth** device and the connection of “Music Flow Bluetooth” app and then try to connect again.
- Depending on the smart phone's operating system, you have some differences for “Music Flow Bluetooth” operation.
- Check **Bluetooth** setting on your **Bluetooth** device if “Music Flow Bluetooth” app connection does not work well.

Radio Operations

Listening to the radio

1. Press **F** on the unit until FM appears in the display window.
The last received station is tuned in.
2. Auto tuning :
Press and hold **|<</>>|** on the unit for about two seconds until the frequency indication starts to change, then release. Scanning stops when the unit tunes in a station.

Or

Manual tuning :

Press **|<</>>|** on the unit repeatedly.

3. Adjust the volume by rotating **MASTER VOLUME** on the unit.

Note

Because the antenna is built into the unit, move the unit to a suitable position for better reception.

Presetting the Radio Stations

You can preset 10 stations for FM.

Before tuning, make sure to turn down the volume.

1. Press **F** on the unit until FM appears in the display window.
2. Select the desired frequency by pressing **|<</>>|** on the unit.
3. Press and hold **PRESET/DEMO** on the unit for more than 2 seconds. A preset number will blink in the display window.
4. Press **|<</>>|** on the unit to select the preset number you want.
5. Press **PRESET/DEMO** on the unit. The station is stored.
6. Repeat steps 2 to 5 to store other stations.
7. To listen a preset station, press **PRESET/DEMO** on the unit.

Deleting all the saved stations

1. Press and hold **AUTO DJ/PRESET DELETE** on the unit for two seconds. "DEL ALL" will flash up on the unit display.
2. Press **AUTO DJ/PRESET DELETE** on the unit to erase all the saved radio stations.

Sound adjustment

Setting the sound mode

This system has a number of pre-set surround sound fields. The displayed items for the equalizer may be different depending on sound sources and effects.

You can select a desired sound mode by using **SOUND EFFECT/BASS BLAST** on the unit.

On Display	Description
BASS (BASS BLAST)	Reinforces the treble, bass and surround sound effect.
POP CLASSIC ROCK JAZZ	This program lends an enthusiastic atmosphere to the sound, giving you the feeling you are at an actual rock, pop, jazz or classic concert.
FOOT BALL	You can enjoy the sound effect FOOTBALL STADIUM.
STANDARD	You can enjoy optimized sound.
Local Specialization equalizer	Optimized sound effect for the music genre preferred in each region. (REGUETON/SAMBA/MERENGUE/AXE/SALSA/SERTANEJ/FORRO/ARABIC/DANGDUT/AFRO/INDIA/ FUNK)

Note

By pressing and holding **SOUND EFFECT/BASS BLAST** on the unit for 3 seconds you can directly select BASS (BASS BLAST) effect.

Setting the USER EQ

You can adjust the sound level of Bass, Middle and Treble as your preference.

1. Press **USER EQ/PARTY LINK** on the unit. "USER EQ" is displayed.
2. Press **USER EQ/PARTY LINK** on the unit repeatedly until desired setting appears in the display window.
3. Rotate **MIC VOLUME/LEVEL CONTROL** on the unit to adjust the value.

Other Operations

DEMO

In the power off state, press **PRESET/DEMO** on the unit once. The unit will power on and display the each of functions with demo sound in the display window. To cancel the DEMO function, press **PRESET/DEMO** on the unit once more.

! Note

You can enjoy other functions during the DEMO, the DEMO will temporarily pause.
- Without input key in 10 sec, the DEMO will playback automatically.

Using Microphone

1. Connect your microphone to the MIC jack.
2. Play the music you want.
3. Sing along with the accompaniment.
Adjust the microphone volume by rotating **MIC VOLUME/LEVEL CONTROL** on the unit.

! Note

- When not using the microphone, set the MIC volume to minimum or turn off the MIC and remove the microphone from the MIC jack.
- If the microphone is set too near the speaker, a howling sound may be produced. In this case, move the microphone away from the speaker or decrease the sound level by using the **MIC VOLUME/LEVEL CONTROL** on the unit.
- If sound through the microphone is extremely loud, it may be distorted. In this case, rotate **MIC VOLUME/LEVEL CONTROL** on the unit to minimum.
- You can give an echo effect to the sound from the microphones by pressing **ECHO** on the unit.

VOICE CANCELLER

You can enjoy the function while playing the music, by reducing singer vocal of music in the various source.

Press the **VOICE CANCELLER** on the unit and "ON" will appear in display window.

To cancel it, press **VOICE CANCELLER** on the unit again.

! Note

- This function is available USB or BT (**Bluetooth**) function.
- If the function is not available, "NOT SUPPORT" appears in the display window.
- This function is available to use only when a microphone is connected.
- If a microphone is not connected, "INSERT MIC" appears in the display window.
- It is not available on the mono source.
- To initialize it, change the function or disconnect the microphone.
- This function may not be initialized depending on the status of connected devices.

KEY CHANGER

You can adjust the key to 9 steps (4 steps higher; 4 steps lower and the original key).

1. Set on the key changer by using the **KEY CHANGER** on the unit.
2. Adjusting the key by rotating the **MIC VOLUME/ LEVEL CONTROL** on the unit.

! Note

- This function is available USB or BT (**Bluetooth**) function.
- To initialize it, change the function, disconnect the microphone or change the music.
- This function may not be initialized depending on the status of connected devices.
- If the function is not available, "NOT SUPPORT" appears in the display window.
- If a microphone is not connected, "INSERT MIC" appears in the display window.

VOCAL EFFECTS

When you connect your microphone to the MIC jack, you can enjoy karaoke function by changing voice in the various source.

To select various mode, press **VOCAL EFFECTS** on the unit repeatedly or press **VOCAL EFFECTS** then press **⏪/⏩** on the unit when vocal effects mode appears in the display window.

BASS → SOPRANO → HELIUM → ROBOT →
 DUET MAN → DUET WOMAN → BASS ECHO1
 → SOPRANO ECHO1 → HELIUM ECHO1
 → ROBOT ECHO1 → DUET MAN1 → DUET
 WOMAN1 → BASS ECHO2 → SOPRANO
 ECHO2 → HELIUM ECHO2 → ROBOT ECHO2
 → DUET MAN2 → DUET WOMAN2 → OFF

! Note

- If a microphone is not connected, "INSERT MIC" appears in the display window.
- If you press **KEY CHANGER** or **ECHO** on the unit on VOCAL EFFECTS mode, after backing up current VOCAL EFFECTS, turn off VOCAL EFFECTS mode and operate KEY CHANGER or ECHO mode.
- To turn off VOCAL EFFECTS mode, press and hold **VOCAL EFFECTS**.

ECHO

When you connect your microphone to the MIC jack, you can give an echo effect to the sound from the microphones by pressing **ECHO** on the unit.

ECHO 1 → ECHO 2 → ECHO OFF

! Note

- If a microphone is not connected, "INSERT MIC" appears in the display window.
- If you press **VOCAL EFFECTS** on the unit button on ECHO mode, after backing up current ECHO, turn off ECHO mode and operate VOCAL EFFECTS mode. Press **ECHO** on the unit again, after backing up current VOCAL EFFECTS, operate ECHO mode.

Auto power down

This unit will turn itself off to save electricity in the case where the main unit is not connected to an external device and is not used for 15 minutes. The unit will also turn itself off after six hours if the main unit has been connected to another device using the analog inputs.

Auto power down function is applied to only MASTER unit in case of WIRELESS PARTY LINK connection. In case of SLAVE unit, Auto power down is available after disconnection SLAVE unit and MASTER unit.

AUTO POWER On

This unit automatically turns on by an input source : LG TV or **Bluetooth**

When you turn on your TV connected to this unit, this unit recognizes the input signal and selects the suitable function. You can hear the sound from the unit.

If you try to connect your **Bluetooth** device, this unit turns on and connects your **Bluetooth** device. You can play your music.

! Note

- Depending on the connected device, this function may not operate.
- Depending on the connected device, the unit turns on but **Bluetooth** function may not be connected.
- If you disconnect **Bluetooth** connection by this unit, some **Bluetooth** devices try to connect to the unit continually. Therefore it is recommended to disconnect the connection before turning off the unit.
- If you try to connect to the "Music Flow Bluetooth" app, **Bluetooth** function of this unit is turned on.
- If you turn on the unit using LG TV or **Bluetooth** function, proper function of this unit is turned on.
- If you have already paired with this unit, automatically this unit can turn on by an input source when this unit is turned off.
- If you turn off the unit by pressing the power button for more than 5 seconds, Auto Power On function is disabled. To activate it, turn on the unit.

Auto function change

This unit recognizes input signals such as **Bluetooth** and LG TV or connected portable device, and then changes suitable function automatically.

When you try to connect Bluetooth device

When you try to connect your **Bluetooth** device to this unit, **Bluetooth** function is selected. Play your music on the **Bluetooth** device.

When PORT.IN connection is connected

When you connect the portable device to the **PORT. IN** connector, **PORTABLE** function is selected. Play your music on the portable device.

When LG TV is connected

When you turn on your LG TV connected by LG Sound Sync, this unit changes the function to LG TV. You can hear the sound from your TV.

! Note

- This function only works with devices that were previously connected.
- If the **Bluetooth** connection lock function is set, **Bluetooth** and LG TV connection will be only available on **Bluetooth** and LG TV function.

LG Sound Sync



You can control some functions of this unit by your TV's remote control with LG Sound Sync. It is compatible with LG TV that supports LG Sound Sync. Make sure your TV has the LG Sound Sync logo.

Controllable function by LG TV's remote control :

Volume up/down, mute

Refer to the TV's instruction manual for the details of LG Sound Sync.

1. Turn on the unit by pressing  on the unit.
2. Press **F** on the unit until LG TV function is selected.
3. Set up the sound output of TV to listen to the sound through this unit :
TV setting menu [Sound] → [TV Sound output]
→ [LG Sound Sync (Wireless)]

"PAIRED" appears on the display window for about 3 seconds and then you can see "LG TV" on the display window if the TV and this unit are connected normally.

Note

- If the connection fails, check the conditions of this unit and your TV : power, function.
- Make sure of the condition of this unit and the connection in the cases below when using LG Sound Sync.
 - The unit is turned off.
 - Changing to a different function.
 - Disconnecting the wireless connection caused by interference or a distance.
- The amount of time to turn off this unit is different depending on your TV.
- If you try to change the function on using the LG TV function, volume will be changed according to the LG TV volume level.
- Details of TV setting menu vary depending on the manufacturers or models of your TV.
- If you connect LG Sound Sync when "Music Flow Bluetooth" app is connected, control through the app is available.
- If you turned off the unit directly by pressing  on the unit, LG Sound Sync will be disconnected.
To use this function again, you should reconnect the TV and the unit.
- If an LG TV is connected when using **Bluetooth, Bluetooth** is disconnected and the LG TV is connected.
- The volume may be increased when the TV and this unit is connected by LG Sound Sync. Decrease the TV volume and then connect with this unit.
- When you turn on your LG TV connected by LG Sound Sync or enter LG TV function, this unit changes the function to LG TV automatically.
- You should set the TV Sound output manually depending on the LG TV version.

WIRELESS PARTY LINK Connection

The output sound of **A**(MASTER) unit is expanded to **B**(SLAVE) unit.

It is compatible with unit that supports WIRELESS PARTY LINK.

The name of function about sound expansion between the compatible products wired or wirelessly was changed to PARTY LINK or WIRELESS PARTY LINK.

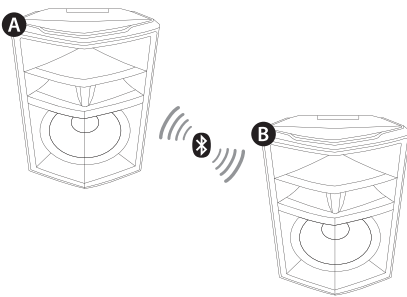

1. Press **WIRELESS LINK** on the unit. PARTY LINK MODE SELECT appears in the display window.
2. Press **WIRELESS LINK** on the unit to select MASTER or SLAVE.
 - **A** unit : Selects MASTER.
 - **B** unit : Selects SLAVE.

Two units try to connect with each other.
3. When this unit is successfully connected each other, "Slave Device Name CONNECTED" appears in the MASTER unit. "CONNECTED TO Master Device Name" appears in the SLAVE unit and change to SLAVE soon.

! Note

- If you using the LG Sound Sync, this function is not available. If you connect the LG TV function, "NOT SUPPORT" appears in the display window.
- You can use microphone in the SLAVE unit only. In case of SLAVE unit, some functions are supported only.
- When WIRELESS PARTY LINK is disconnected, SLAVE unit is changed to BT function.
- If the connection is failed, "FAILED" appears in the display window.
- WIRELESS PARTY LINK connection will be disconnected when you turn off the unit or press **WIRELESS LINK** on the unit.
- Sound of MASTER unit and SLAVE unit may be different depending on playback status or source.
- Check the following information when connecting to **Bluetooth**.
 - You can connect only one **Bluetooth** device in the MASTER unit. You cannot connect **Bluetooth** device to the SLAVE unit.
 - WIRELESS PARTY LINK connection is only supported on Android devices. (WIRELESS PARTY LINK connection may not be supported depending on the connected device specifications or OS.)
 - Removable/detachable **Bluetooth** devices (ex. Dongle etc.) will not support WIRELESS PARTY LINK connection.
- When WIRELESS PARTY LINK is connected, you can not connect Wired PARTY LINK.

Troubleshooting

General

Problem	Cause & Solution
The unit does not work properly	<ul style="list-style-type: none"> • Turn off the power of this unit and the connected external device (TV, Woofer, DVD-player, Amplifier, etc.) and turn them on again. • Disconnect the power cord of this unit and the connected external device (TV, Woofer, DVD-player, Amplifier, etc.) and then try connecting again. • Previous setting may not be saved when device power is shut off.
No Power	<ul style="list-style-type: none"> • The power cord is not plugged in. Plug in the power cord. • Check whether electricity failed. Check the condition by operating other electronic devices.
No sound	<ul style="list-style-type: none"> • Check whether you select right function. Press function button and check the selected function.
Radio stations cannot be tuned in properly	<ul style="list-style-type: none"> • Because the antenna is built into the unit, move the unit to a suitable position for better reception. • The signal strength of the radio station is too weak. Tune to the station manually. • No stations have been preset or preset stations have been cleared (when tuning by scanning preset channels). Preset some radio stations, see page 22 for details.
LG Sound Sync does not work	<ul style="list-style-type: none"> • Check whether your LG TV supports LG Sound Sync. • Check connection of LG Sound Sync. • Check sound setting of your TV and this unit.

General specifications

General	
Power requirements	Refer to the main label on the unit.
Power consumption	Refer to the main label on the unit.
Dimensions (W x H x D)	Approx. 461 mm x 717 mm x 378 mm
Operating temperature	5 °C to 35 °C (41 °F to 95 °F)
Operating humidity	60 %

Inputs / Outputs	
Analog audio in (AUX IN)	1.2 Vrms (THD 10%), 600 Ω , RCA jack (L, R)
Analog audio out (AUX OUT)	2.0 Vrms, 600 Ω , RCA jack (L, R)
Portable in (PORT. IN)	0.63 Vrms (3.5 mm stereo jack) x 1
Microphone (MIC 1/2)	Sensitivity 20 mV (200 Hz), 6.3 mm jack x 2

Tuner	
FM Tuning Range	87.5 to 108.0 MHz or 87.50 to 108.00 MHz

System	
Frequency Response	50 to 18,000 Hz
Signal-to-noise ratio	More than 75 dB
Dynamic range	More than 80 dB
Bus Power Supply (USB)	5 V  1 A

Amplifier (RMS Output power)	
Total output	400 W RMS
Woofer	230 W RMS X 1 (6 Ω at 500 Hz, 30 % THD Under)
Tweeter	170 W RMS X 1 (8 Ω at 5 kHz, 20 % THD Under)

- Design and specifications are subject to change without notice.

Trademarks and Licenses



The **Bluetooth**® word mark and logos are registered trademarks owned by the Bluetooth SIG, Inc. and any use of such marks by LG Electronics is under license. Other trademarks and trade names are those of their respective owners.

Maintenance

Handling the Unit

When shipping the unit

Please save the original shipping carton and packing materials. If you need to ship the unit, for maximum protection, re-pack the unit as it was originally packed at the factory.

Keeping the exterior surfaces clean

Do not use volatile liquids such as insecticide spray near the unit. Wiping with strong pressure may damage the surface. Do not leave rubber or plastic products in contact with the unit for a long period of time.

Cleaning the unit

To clean the player, use a soft, dry cloth. If the surfaces are extremely dirty, use a soft cloth lightly moistened with a mild detergent solution. Do not use strong solvents such as alcohol, benzene, or thinner, as these might damage the surface of the unit.

