

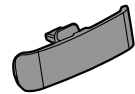

(1903-REV01)
Printed in Korea

55UM7650PUB
65UM7650PUB

www.lg.com

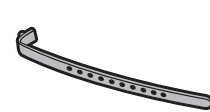
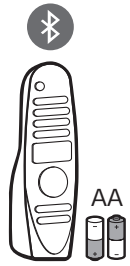
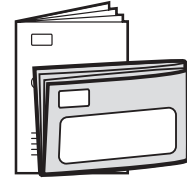
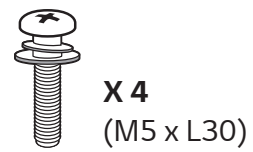
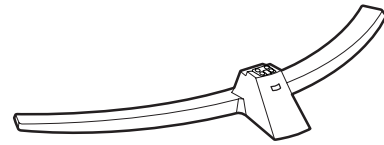

ENGLISH Read **Safety and Reference**.

ESPAÑOL Leer **Seguridad y Consultas**.

FRANÇAIS Lisez **Sécurité et références**.

ENGLISH

Easy Setup Guide

Please read this manual carefully before operating your set and retain it for future reference.

ESPAÑOL

Guía Rápida de Configuración

Lea atentamente este manual antes de poner en marcha el equipo y consérvelo para futuras consultas.

FRANÇAIS

Guide de configuration rapide

Avant d'utiliser l'appareil, veuillez lire attentivement ce manuel et le conserver pour pouvoir vous y reporter ultérieurement.

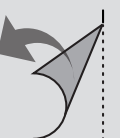
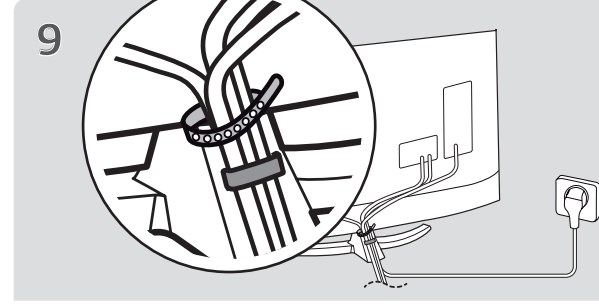
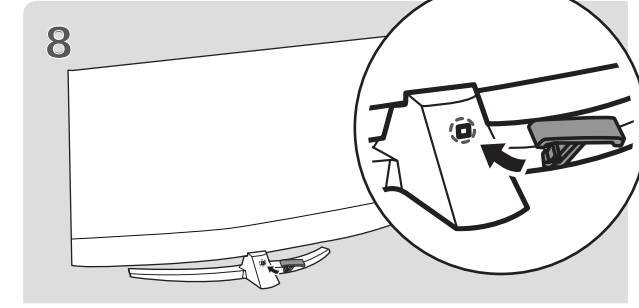
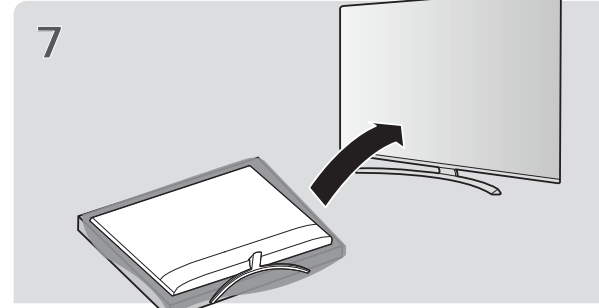
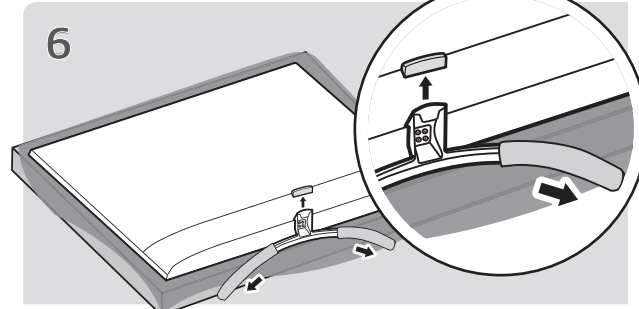
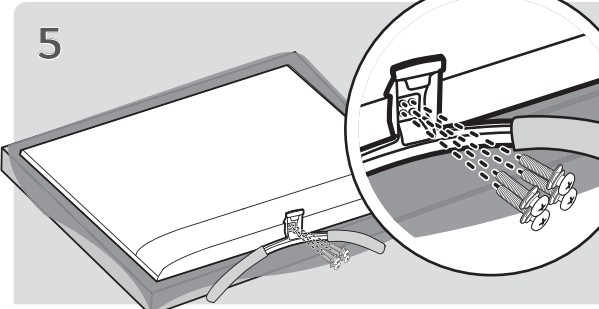
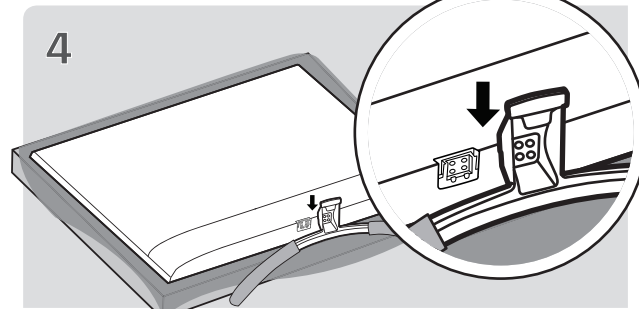
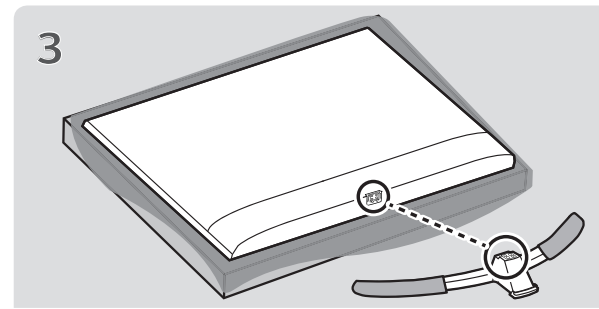
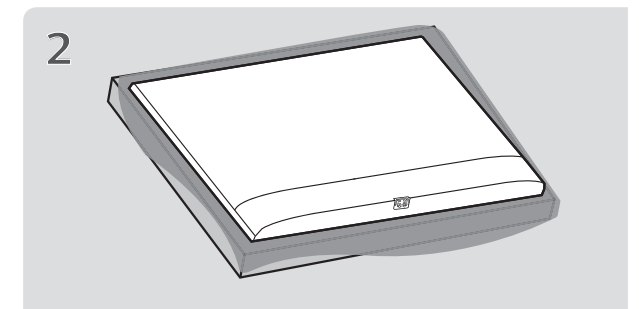
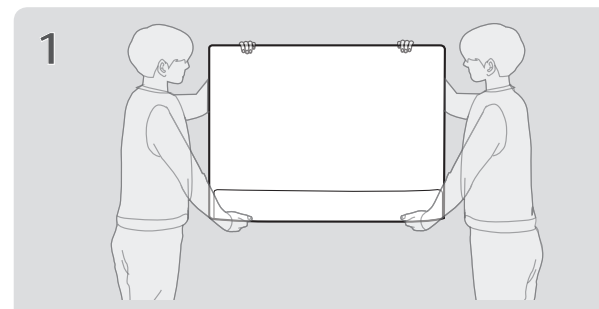



OPTICAL DIGITAL AUDIO OUT

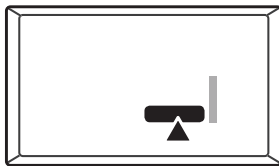
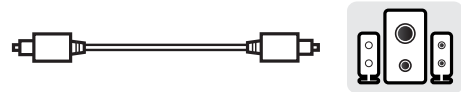

LAN

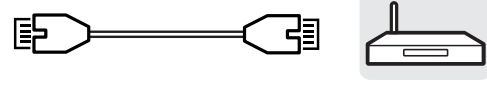

www.lg.com/us/support

ENGLISH
Easy TV Connect Guide (Animation)

ESPAÑOL
Guía Rápida de Conexión del televisor
(Sólo en Inglés)

FRANÇAIS
Guide simplifié pour la connexion du téléviseur
(Offert en anglais seulement)

USB IN



HDMI IN

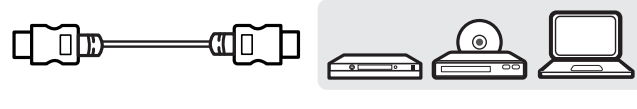

COMPONENT IN

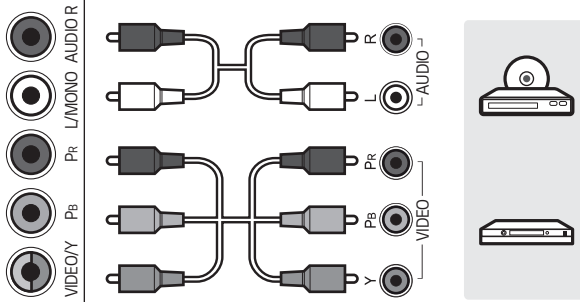

AV IN

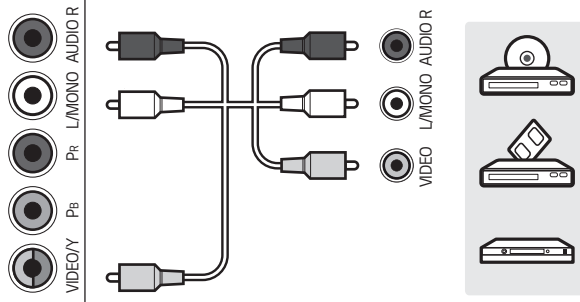

ANTENNA / CABLE IN

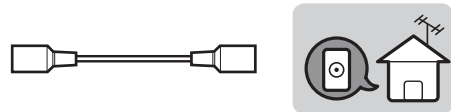

HDMI IN

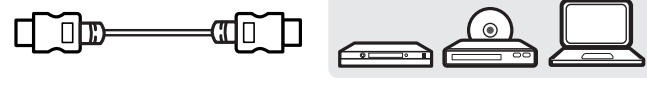

HDMI IN/ARC

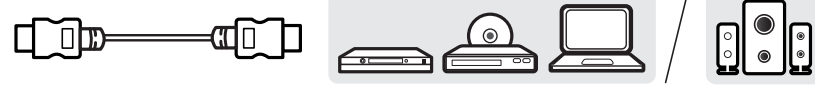

USB IN

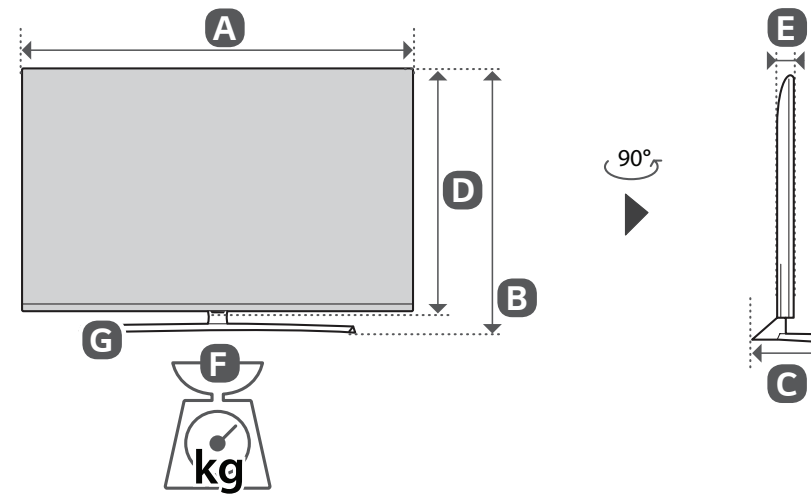
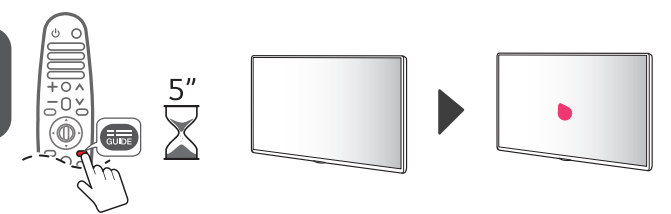
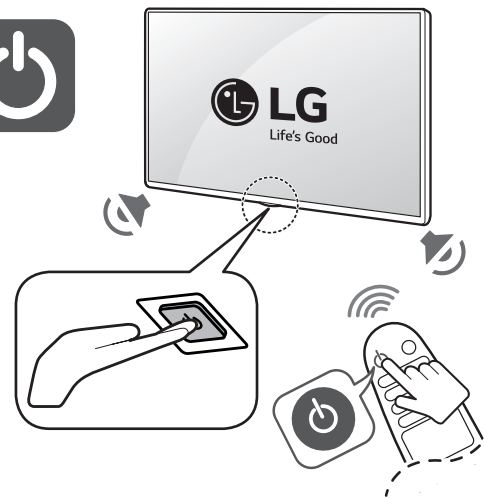
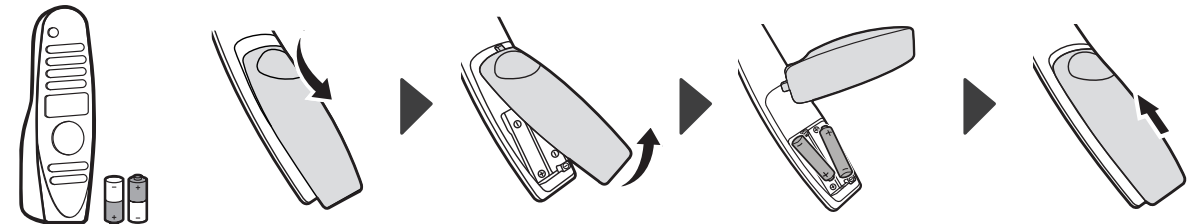

A, B, C, D, E : mm (inches / pulgadas / po)
F, G : kg (lbs / libras / lb)

MODELS	A		B		C		D		E		F		F - G		Power consumption
MODELOS	A		B		C		D		E		F		F - G		Consumo de potencia
MODÈLES	A		B		C		D		E		F		F - G		Consommation électrique
55UM7650PUB	1,234 (48.5)	1 234 (48,5)	784 (30.8)	784 (30,8)	260 (10.2)	260 (10,2)	717 (28.2)	717 (28,2)	84 (3.3)	84 (3,3)	17.1 (37.6)	17,1 (37,6)	16.1 (35.4)	16,1 (35,4)	160 W
65UM7650PUB	1,453 (57.2)	1 453 (57,2)	907 (35.7)	907 (35,7)	340 (13.3)	340 (13,3)	840 (33)	840 (33)	84 (3.3)	84 (3,3)	24.1 (53.1)	24,1 (53,1)	23 (50.7)	23 (50,7)	195 W
Power requirement / Alimentación requerida / Alimentation										AC 120 V ~ 50 / 60 Hz					