

## INSTALLATION MANUAL

# AIR CONDITIONER

Please read this installation manual completely before installing the product.  
Installation work must be performed in accordance with the national wiring  
standards by authorized personnel only.

Please retain this installation manual for future reference after reading it  
thoroughly.

### **MULTI V<sub>IV</sub>**

Original instruction

[Representative] LG Electronics Inc. EU Representative : LG Electronics European Shared Service Center B.V.  
Krijgsman 1, 1186 DM Amstelveen, The Netherlands

[Manufacturer] LG Electronics Inc. Changwon 2nd factory 84, Wanam-ro, Seongsan-gu, Changwon-si,  
Gyeongsangnam-do, KOREA

For more information, Refer to the CD or LG Web site ([www.lg.com](http://www.lg.com)).



P/NO : MFL67221416

[www.lg.com](http://www.lg.com)

ENGLISH

ITALIANO

ESPAÑOL

FRANÇAIS

DEUTSCH

ČEŠTINA

ΕΛΛΗΝΙΚΑ

NETERLANDS

POLSKI

LIMBA ROMÂNĂ

## TIPS FOR SAVING ENERGY

Here are some tips that will help you minimize the power consumption when you use the air conditioner. You can use your air conditioner more efficiently by referring to the instructions below:

- Do not cool excessively indoors. This may be harmful for your health and may consume more electricity.
- Block sunlight with blinds or curtains while you are operating the air conditioner.
- Keep doors or windows closed tightly while you are operating the air conditioner.
- Adjust the direction of the air flow vertically or horizontally to circulate indoor air.
- Speed up the fan to cool or warm indoor air quickly, in a short period of time.
- Open windows regularly for ventilation as the indoor air quality may deteriorate if the air conditioner is used for many hours.
- Clean the air filter once every 2 weeks. Dust and impurities collected in the air filter may block the air flow or weaken the cooling / dehumidifying functions.

### For your records

Staple your receipt to this page in case you need it to prove the date of purchase or for warranty purposes. Write the model number and the serial number here:

Model number : \_\_\_\_\_

Serial number : \_\_\_\_\_

You can find them on a label on the side of each unit.

Dealer's name : \_\_\_\_\_

Date of purchase : \_\_\_\_\_

## IMPORTANT SAFETY INSTRUCTIONS

### **READ ALL INSTRUCTIONS BEFORE USING THE APPLIANCE.**

Always comply with the following precautions to avoid dangerous situations and ensure peak performance of your product

### **⚠ WARNING**

It can result in serious injury or death when the directions are ignored

### **⚠ CAUTION**

It can result in minor injury or product damage when the directions are ignored

### **⚠ WARNING**

- Installation or repairs made by unqualified persons can result in hazards to you and others.
- The information contained in the manual is intended for use by a qualified service technician familiar with safety procedures and equipped with the proper tools and test instruments.
- Failure to carefully read and follow all instructions in this manual can result in equipment malfunction, property damage, personal injury and/or death.

### Installation

- Have all electric work done by a licensed electrician according to "Electric Facility Engineering Standard" and "Interior Wire Regulations" and the instructions given in this manual and always use a special circuit.
  - If the power source capacity is inadequate or electric work is performed improperly, electric shock or fire may result.
- Ask the dealer or an authorized technician to install the air conditioner.
  - Improper installation by the user may result in water leakage, electric shock, or fire.
- Always ground the product.
  - There is risk of fire or electric shock.
- Always install a dedicated circuit and breaker.
  - Improper wiring or installation may cause fire or electric shock.
- For re-installation of the installed product, always contact a dealer or an Authorized Service Center.
  - There is risk of fire, electric shock, explosion, or injury.
- Do not install, remove, or re-install the unit by yourself (customer).
  - There is risk of fire, electric shock, explosion, or injury.
- Do not store or use flammable gas or combustibles near the air conditioner.
  - There is risk of fire or failure of product.
- Use the correctly rated breaker or fuse.
  - There is risk of fire or electric shock.
- Prepare for strong wind or earthquake and install the unit at the specified place.

- Improper installation may cause the unit to topple and result in injury.
- Do not install the product on a defective installation stand.
  - It may cause injury, accident, or damage to the product.
- Use a vacuum pump or Inert(nitrogen) gas when doing leakage test or air purge. Do not compress air or Oxygen and do not use Flammable gases. Otherwise, it may cause fire or explosion.
  - There is the risk of death, injury, fire or explosion.
- When installing and moving the air conditioner to another site, do not charge it with a different refrigerant from the refrigerant specified on the unit.
  - If a different refrigerant or air is mixed with the original refrigerant, the refrigerant cycle may malfunction and the unit may be damaged.
- Do not reconstruct to change the settings of the protection devices.
  - If the pressure switch, thermal switch, or other protection device is shorted and operated forcibly, or parts other than those specified by LGE are used, fire or explosion may result.
- Ventilate before operating air conditioner when gas leaked out.
  - It may cause explosion, fire, and burn.
- Securely install the cover of control box and the panel.
  - If the cover and panel are not installed securely, dust or water may enter the outdoor unit and fire or electric shock may result.
- If the air conditioner is installed in a small room, measures must be taken to prevent the refrigerant concentration from exceeding the safety limit when the refrigerant leaks.
  - Consult the dealer regarding the appropriate measures to prevent the safety limit from being exceeded. Should the refrigerant leak and cause the safety limit to be exceeded, hazards due to lack of oxygen in the room could result.

## Operation

- Do not damage or use an unspecified power cord.
  - There is risk of fire, electric shock, explosion, or injury.
- Use a dedicated outlet for this appliance.
  - There is risk of fire or electrical shock.
- Be cautious that water could not enter the product.
  - There is risk of fire, electric shock, or product damage.
- Do not touch the power switch with wet hands.
  - There is risk of fire, electric shock, explosion, or injury.
- When the product is soaked (flooded or submerged), contact an Authorized Service Center.
  - There is risk of fire or electric shock.
- Be cautious not to touch the sharp edges when installing.
  - It may cause injury.
- Take care to ensure that nobody could step on or fall onto the outdoor unit.
  - This could result in personal injury and product damage.
- Do not open the inlet grille of the product during operation. (Do not touch the electrostatic filter, if the unit is so equipped.)
  - There is risk of physical injury, electric shock, or product failure.

## CAUTION

### Installation

- Always check for gas (refrigerant) leakage after installation or repair of product.
  - Low refrigerant levels may cause failure of product.
- Do not install the product where the noise or hot air from the outdoor unit could damage the neighborhoods.
  - It may cause a problem for your neighbors.
- Keep level even when installing the product.
  - To avoid vibration or water leakage.
- Do not install the unit where combustible gas may leak.
  - If the gas leaks and accumulates around the unit, an explosion may result.

- Use power cables of sufficient current carrying capacity and rating.
  - Cables that are too small may leak, generate heat, and cause a fire.
- Do not use the product for special purposes, such as preserving foods, works of art, etc. It is a consumer air conditioner, not a precision refrigeration system.
  - There is risk of damage or loss of property.
- Keep the unit away from children. The heat exchanger is very sharp.
  - It can cause the injury, such as cutting the finger. Also the damaged fin may result in degradation of capacity.
- When installing the unit in a hospital, communication station, or similar place, provide sufficient protection against noise.
  - The inverter equipment, private power generator, high-frequency medical equipment, or radio communication equipment may cause the air conditioner to operate erroneously, or fail to operate. On the other hand, the air conditioner may affect such equipment by creating noise that disturbs medical treatment or image broadcasting.
- Do not install the product where it is exposed to sea wind (salt spray) directly.
  - It may cause corrosion on the product. Corrosion, particularly on the condenser and evaporator fins, could cause product malfunction or inefficient operation.

### Operation

- Do not use the air conditioner in special environments.
  - Oil, steam, sulfuric smoke, etc. can significantly reduce the performance of the air conditioner or damage its parts.
- Do not block the inlet or outlet.
  - It may cause failure of appliance or accident.
- Make the connections securely so that the outside force of the cable may not be applied to the terminals.
  - Inadequate connection and fastening may generate heat and cause a fire.
- Be sure the installation area does not deteriorate with age.
  - If the base collapses, the air conditioner could fall with it, causing property damage,

- product failure, or personal injury.
- Install and insulate the drain hose to ensure that water is drained away properly based on the installation manual.
  - A bad connection may cause water leakage.
- Be very careful about product transportation.
  - Only one person should not carry the product if it weighs more than 20 kg.
  - Some products use PP bands for packaging. Do not use any PP bands for a means of transportation. It is dangerous.
  - Do not touch the heat exchanger fins. Doing so may cut your fingers.
  - When transporting the outdoor unit, suspending it at the specified positions on the unit base. Also support the outdoor unit at four points so that it cannot slip sideways.
- Safely dispose of the packing materials.
  - Packing materials, such as nails and other metal or wooden parts, may cause stabs or other injuries.
  - Tear apart and throw away plastic packaging bags so that children may not play with them. If children play with a plastic bag which was not torn apart, they face the risk of suffocation.
- Turn on the power at least 6 hours before starting operation.
  - Starting operation immediately after turning on the main power switch can result in severe damage to internal parts. Keep the power switch turned on during the operational season.
- Do not touch any of the refrigerant piping during and after operation.
  - It can cause a burn or frostbite.
- Do not operate the air conditioner with the panels or guards removed.
  - Rotating, hot, or high-voltage parts can cause injuries.
- Do not directly turn off the main power switch after stopping operation.
  - Wait at least 5 minutes before turning off the main power switch. Otherwise it may result in water leakage or other problems.
- Auto-addressing should be done in condition of connecting the power of all indoor and outdoor units. Auto-addressing should also

be done in case of changing the indoor unit PCB.

- Use a firm stool or ladder when cleaning or maintaining the air conditioner.
  - Be careful and avoid personal injury.
- Do not insert hands or other objects through the air inlet or outlet while the air conditioner is plugged in.
  - There are sharp and moving parts that could cause personal injury.

## TABLE OF CONTENTS

<b>2</b>	<b>TIPS FOR SAVING ENERGY</b>
<b>2</b>	<b>IMPORTANT SAFETY INSTRUCTIONS</b>
<b>6</b>	<b>INSTALLATION PROCESS</b>
<b>6</b>	<b>OUTDOOR UNITS INFORMATION</b>
<b>6</b>	<b>ALTERNATIVE REFRIGERANT R410A</b>
<b>6</b>	<b>SELECT THE BEST LOCATION</b>
<b>8</b>	<b>INSTALLATION SPACE</b>
8	Individual Installation
<b>8</b>	<b>LIFTING METHOD</b>
<b>9</b>	<b>INSTALLATION</b>
9	The location of the Anchor bolts
9	Foundation for Installation
9	Preparation of Piping
11	Plumbing materials and storage methods
<b>11</b>	<b>REFRIGERANT PIPING INSTALLATION</b>
11	Precautions on Pipe connection / Valve operation
12	Connection of Outdoor units
12	Installation procedure for HR unit
12	Installation of Outdoor Unit, HR Unit, Indoor Unit Refrigerant Pipe
12	Type of HR Unit
13	Installation of Zoning Control
13	Caution
<b>14</b>	<b>PIPE CONNECTIONS BETWEEN INDOOR AND OUTDOOR UNIT</b>
14	Preparation Work
14	Pipe Drawing Out during Single / Series connection
15	Refrigerant piping system
19	Refrigerant charging
20	Branch pipe Fitting
21	Leak Test and Vacuum drying
22	Vacuum Mode
22	Thermal insulation of refrigerant piping
<b>23</b>	<b>ELECTRICAL WIRING</b>
23	Caution
24	Control box and connecting position of wiring
24	Communication and Power Cables
25	Wiring of main power supply and equipment capacity
25	Point for attention regarding quality of the public electric power supply
26	Field Wiring
27	Checking the setting of outdoor units
<b>28</b>	<b>HR Unit PCB</b>
28	Switch for setup of HR Unit
29	Automatic Addressing
30	The Procedure of Automatic Addressing
30	Flow chart of auto addressing for pipe detection
31	Flow chart of manual addressing for pipe detection
31	Example of manual valve addressing (Non-Zoning setting)
31	Example of manual valve addressing (Zoning setting)
32	Example of checking valve address
32	Identification of Manual Valve ID (Address)
32	Method of checking the pipe detection result at outdoor unit
32	Setting method of Master indoor unit in zoning
32	Group Number setting
33	Static pressure compensation mode
33	Night Low Noise Function
33	Overall defrost mode
34	Setting the ODU address
34	Snow removal & rapid defrost
34	IDU capacity adjusting
34	Target pressure adjusting
34	Comfort Operation
35	Self-Diagnosis Function
<b>37</b>	<b>CAUTION FOR REFRIGERANT LEAK</b>
37	Introduction
37	Checking procedure of limiting concentration
<b>38</b>	<b>INSTALLATION GUIDE AT THE SEASIDE</b>
39	Model Designation
39	Airborne Noise Emission

## INSTALLATION PROCESS

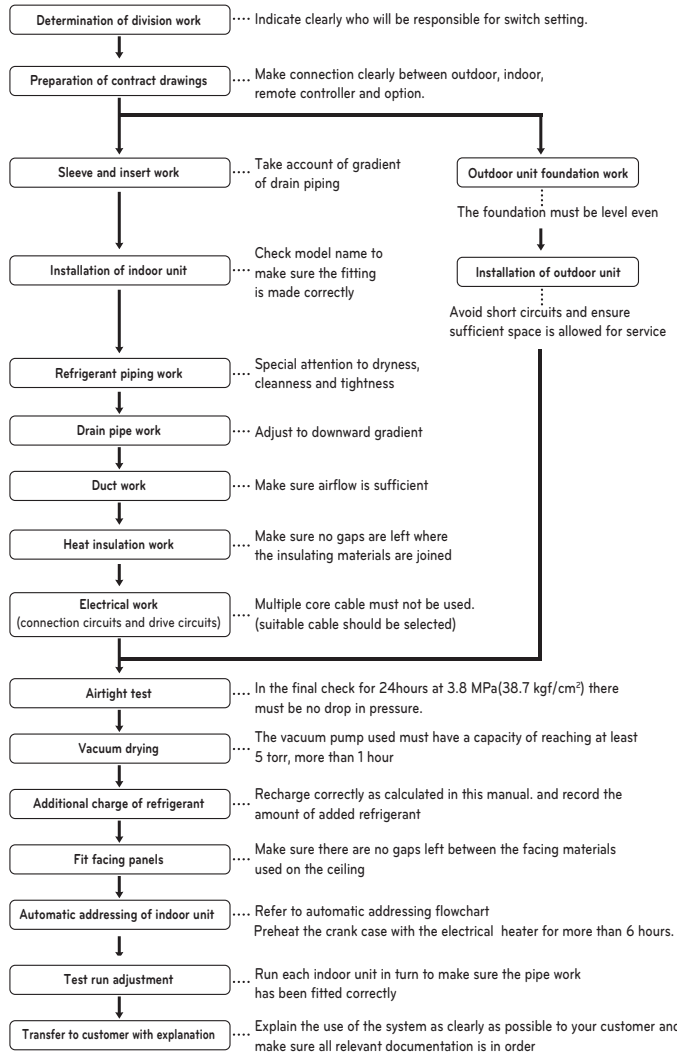

### CAUTION

- The above list indicates the order in which the individual work operations are normally carried out but this order may be varied where local conditions warrants such change.
- The thickness of the piping should comply with the relevant local and national regulations for the designed pressure 3.8MPa.
- Since R410A is a mixed refrigerant, the required additional refrigerant must be charged in its liquid state.(If the refrigerant is charged in its gaseous state, its composition changes and the system will not work properly.)

## OUTDOOR UNITS INFORMATION

### CAUTION

#### Combination Ratio(50~200%)

Outdoor Number	Connection Ratio
Single outdoor units	200%
Double outdoor units	160%
Triple outdoor units	130%
Over the triple unit	130%

Notes : \* We can guarantee the operation only within 130% Combination. If you want to connect more than 130% combination, please contact us and discuss the requirement like below.

- If the operation of indoor unit is more than 130%, the airflow is operated as low in the all indoor units.

## ALTERNATIVE REFRIGERANT R410A

The refrigerant R410A has the property of higher operating pressure in comparison with R22.

Therefore, all materials have the characteristics of higher resisting pressure than R22 ones and this characteristic should be also considered during the installation.

R410A is an azeotrope of R32 and R125 mixed at 50:50, so the ozone depletion potential (ODP) of R410A is 0.

### CAUTION

- The wall thickness of the piping should comply with the relevant local and national regulations for the designed pressure 3.8MPa
- Since R410A is a mixed refrigerant, the required additional refrigerant must be charged in its liquid state. If the refrigerant is charged in its gaseous state, its composition changes and the system will not work properly.
- Do not place the refrigerant container under the direct rays of the sun to prevent it from exploding.
- For high-pressure refrigerant, any unapproved pipe must not be used.
- Do not heat pipes more than necessary to prevent them from softening.
- Be careful not to install wrongly to minimize economic loss because it is expensive in comparison with R22.

## SELECT THE BEST LOCATION

Select space for installing outdoor unit, which will meet the following conditions:

- No direct thermal radiation from other heat sources
- No possibility of annoying neighbors by noise from unit
- No exposition to strong wind
- With strength which bears weight of unit
- Note that drain flows out of unit when heating
- With space for air passage and service work shown next
- Because of the possibility of fire, do not install unit to the space where generation, inflow, stagnation, and leakage of combustible gas is expected.
- Avoid unit installation in a place where acidic solution and spray (sulfur) are often used.
- Do not use unit under any special environment where oil, steam and sulfuric gas exist.
- It is recommended to fence round the outdoor unit in order to prevent any person or animal from accessing the outdoor unit.
- If installation site is area of heavy snowfall, then the following directions should be observed.
  - Make the foundation as high as possible.
  - Fit a snow protection hood.
- Select installation location considering following conditions to avoid bad condition when additionally performing defrost operation.
  - Install the outdoor unit at a place well ventilated and having a lot of sunshine in case of installing the product at a place With a high humidity in winter (near beach, coast, lake, etc.) (Ex : Rooftop where there is always sunshine.)

### Select installation location of the HR unit suitable for following conditions

- Avoid a place where rain may enter since the HR unit is for indoor.
- Sufficient service space must be obtained.
- Refrigerant pipe must not exceed limited length.
- Avoid a place subject to a strong radiation heat from other heat source.
- Avoid a place where oil spattering, vapor spray or high frequency electric noise is expected.
- Install the unit at a place in which it is not affected by operation noise. (Installation within cell such as meeting room etc. may disturb business due to noise.)
- Place where refrigerant piping, drain piping and electrical wiring works are easy.

(Unit: mm)

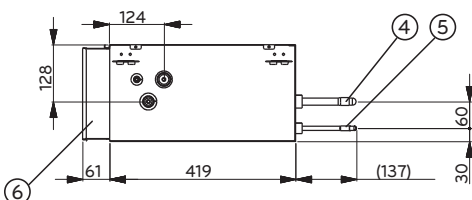
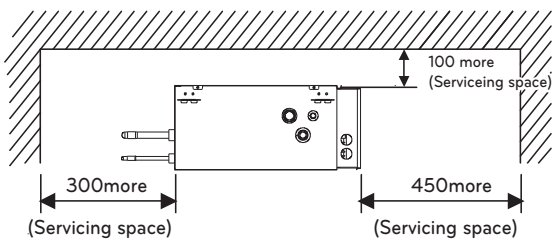
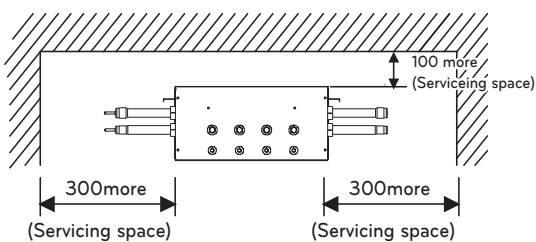
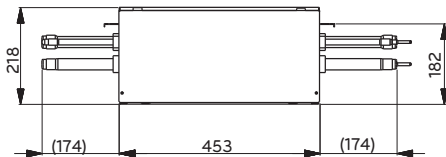
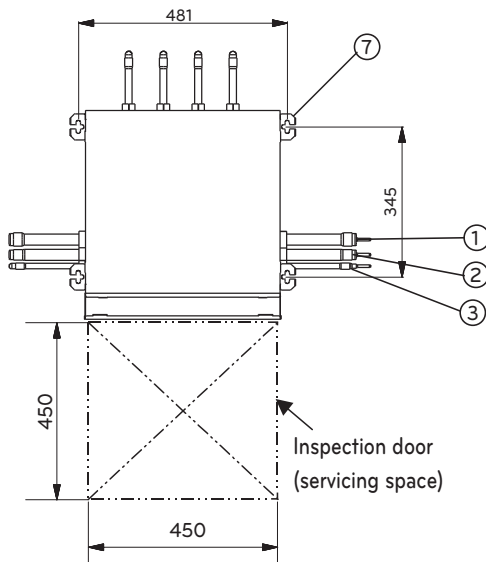

No.	Part Name	Description	
		PRHR041/031	PRHR021
1	Low pressure Gas pipe connection port	Ø28.58 Brazing connection	Ø22.2 Brazing connection
2	High pressure Gas pipe connection port	Ø22.2 Brazing connection	Ø19.05 Brazing connection
3	Liquid pipe connection port	Ø15.88 Brazing connection (PRHR041)	Ø9.52 Brazing connection
		Ø12.7 Brazing connection (PRHR031)	
4	Indoor unit Gas pipe connection port	Ø15.88 Brazing connection	Ø15.88 Brazing connection
5	Indoor unit Liquid pipe connection port	Ø9.52 Brazing connection	Ø9.52 Brazing connection
6	Control box	-	-
7	Hanger metal	M10 or M8	M10 or M8

### NOTE

- Be sure to install the inspection door at the control box side.
- If reducers are used, servicing space must be increased equal to reducer's dimension.

# INSTALLATION SPACE

## Individual Installation

During the installation of the unit, consider service, inlet, and outlet acquire the minimum space as shown in the figures below.

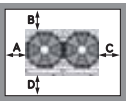
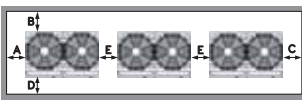
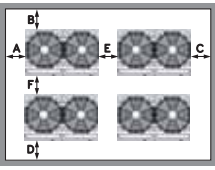
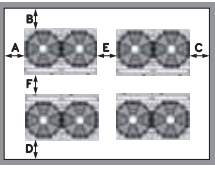
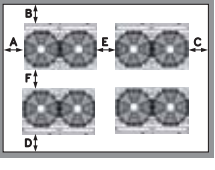
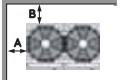
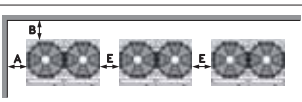
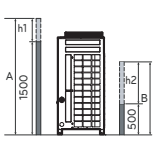
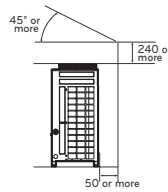
Category	Installation Space	Case 1 (10mm ≤ Side Space ≤ 49mm)	Case 2 (Side Space ≥ 49mm)
4 sides are walls		A ≥ 10 B ≥ 300 C ≥ 10 D ≥ 500	A ≥ 50 B ≥ 100 C ≥ 50 D ≥ 500
		A ≥ 10 B ≥ 300 C ≥ 10 D ≥ 500 E ≥ 20	A ≥ 50 B ≥ 100 C ≥ 50 D ≥ 500 E ≥ 100
		A ≥ 10 B ≥ 300 C ≥ 10 D ≥ 500 E ≥ 20 F ≥ 600	A ≥ 50 B ≥ 100 C ≥ 50 D ≥ 500 E ≥ 100 F ≥ 500
		A ≥ 10 B ≥ 300 C ≥ 10 D ≥ 300 E ≥ 20 F ≥ 500	A ≥ 50 B ≥ 100 C ≥ 50 D ≥ 100 E ≥ 100 F ≥ 500
		A ≥ 10 B ≥ 500 C ≥ 10 D ≥ 500 E ≥ 20 F ≥ 900	A ≥ 50 B ≥ 500 C ≥ 50 D ≥ 500 E ≥ 100 F ≥ 600
Only 2 sides are walls		A ≥ 10 B ≥ 300	
		A ≥ 200 B ≥ 300 E ≥ 400	
Limitations on the height of the wall (Refer to 4 side walls)		<ul style="list-style-type: none"> <li>The height of the wall on the front side must be 1500mm or less.</li> <li>The height of the wall on the inlet side must be 500mm or less.</li> <li>There is no limit to the wall on the side.</li> <li>If the height of the walls on the front and the side are higher than the limit, there must be additional space on the front and the side.               <ul style="list-style-type: none"> <li>- Additional Space on the front side by 1/2 of h1.</li> <li>- Additional Space on the inlet side by 1/2 of h2</li> <li>- h1 = A(Actual height) - 1500</li> <li>- h2 = B(Actual height) - 500</li> </ul> </li> </ul>	
			

### Seasonal wind and cautions in winter

- Sufficient measures are required in a snow area or severe cold area in winter so that product can be operated well.
- Get ready for seasonal wind or snow in winter even in other areas.
- Install a suction and discharge duct not to let in snow or rain.
- Install the outdoor unit not to come in contact with snow directly. If snow piles up and freezes on the air suction hole, the system may malfunction. If it is installed at snowy area, attach the hood to the system.

- Install the outdoor unit at the higher installation console by 50cm than the average snowfall (annual average snowfall) if it is installed at the area with much snowfall.
- Where snow accumulated on the upper part of the Outdoor Unit by more than 10cm, always remove snow for operation.

- The height of H frame must be more than 2 times the snowfall and its width shall not exceed the width of the product. (If width of the frame is wider than that of the product, snow may accumulate)
- Don't install the suction hole and discharge hole of the Outdoor Unit facing the seasonal wind.

## LIFTING METHOD

- When carrying the suspended, unit pass the ropes under the unit and use the two suspension points each at the front and rear.
- Always lift the unit with ropes attached at four points so that impact is not applied to the unit.
- Attach the ropes to the unit at an angle of 40° or less.

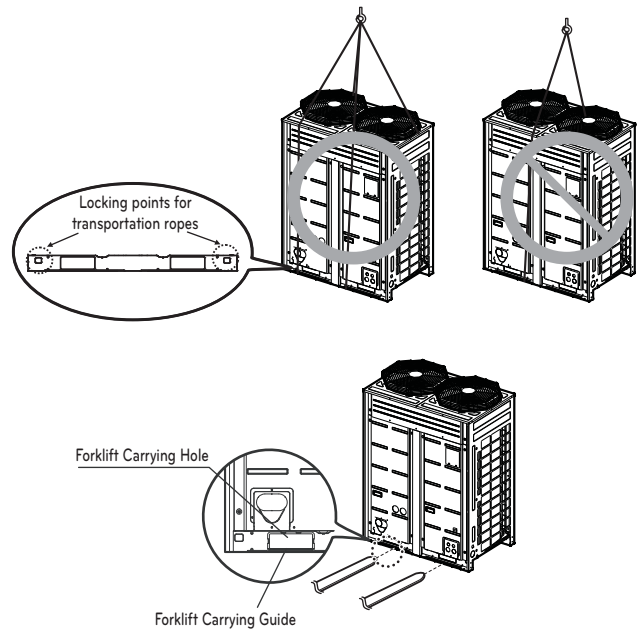

### ! CAUTION

#### Be very careful while carrying the product.

- Do not have only one person carry product if it is more than 20 kg.
- PP bands are used to pack some products. Do not use them as a mean for transportation because they are dangerous.
- Do not touch heat exchanger fins with your bare hands. Otherwise you may get a cut in your hands.
- Tear plastic packaging bag and scrap it so that children cannot play with it. Otherwise plastic packaging bag may suffocate children to death.
- When carrying in Outdoor Unit, be sure to support it at four points. Carrying in and lifting with 3-point support may make Outdoor Unit unstable, resulting in a fall.
- Use 2 belts of at least 8 m long.
- Place extra cloth or boards in the locations where the casing comes in contact with the sling to prevent damage.
- Hoist the unit making sure it is being lifted at its center of gravity.

# INSTALLATION

- Install at places where it can endure the weight and vibration/noise of the outdoor unit.
- The outdoor unit supports at the bottom shall have width of at least 100mm under the Unit's legs before being fixed.
- The outdoor unit supports should have minimum height of 200mm.
- Anchor bolts must be inserted at least 75mm.

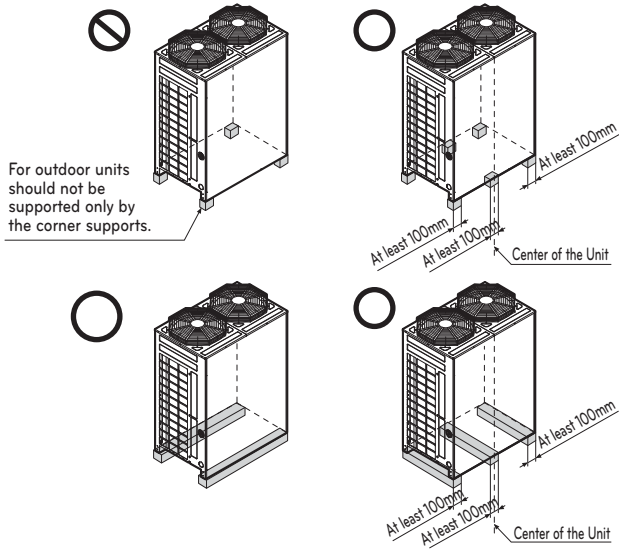

## The location of the Anchor bolts

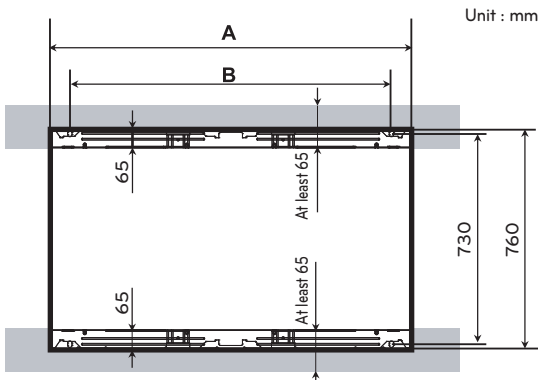

Chassis	Outdoor Unit Capacity	A(mm)	B(mm)
UX2	8~12 HP	920	792
UX3	14~20 HP	1240	1102

## Foundation for Installation

- Fix the unit tightly with bolts as shown below so that unit will not fall down due to earthquake or gust.
- Use the H-beam support as a base support
- Noise and vibration may occur from the floor or wall since vibration is transferred through the installation part depending on installation status. Thus, use anti-vibration materials (cushion pad) fully (The base pad shall be more than 200mm).

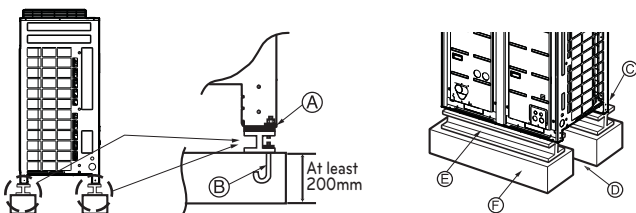

- (A) The corner part must be fixed firmly. Otherwise, the support for the installation may be bent.
- (B) Get and use M10 Anchor bolt.
- (C) Put Cushion Pad between the outdoor unit and ground support for the vibration protection in wide area.
- (D) Space for pipes and wiring (Pipes and wirings for bottom side)
- (E) H-beam support
- (F) Concrete support

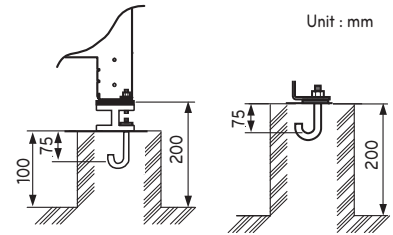

### WARNING

- Install where it can sufficiently support the weight of the outdoor unit. If the support strength is not enough, the outdoor unit may drop and hurt people.
- Install where the outdoor unit may not fall in strong wind or earthquake. If there is a fault in the supporting conditions, the outdoor unit may fall and hurt people.
- Please take extra cautions on the supporting strength of the ground, water outlet treatment (treatment of the water flowing out of the outdoor unit in operation), and the passages of the pipe and wiring, when making the ground support.
- Do not use tube or pipe for water outlet in the Base pan. Use drainage instead for water outlet. The tube or pipe may freeze and the water may not be drained.

### CAUTION

- Be sure to remove the Pallet (Wood Support) of the bottom side of the outdoor unit Base Pan before fixing the bolt. It may cause the unstable state of the outdoor settlement, and may cause freezing of the heat exchanger resulting in abnormal operations.
- Be sure to remove the Pallet (Wood Support) of the bottom side of the outdoor unit before welding. Not removing Pallet (Wood Support) causes hazard of fire during welding.

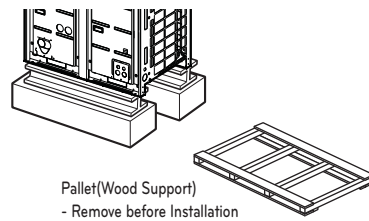

## Preparation of Piping

Main cause of gas leakage is defect in flaring work. Carry out correct flaring work in the following procedure.

### Cut the pipes and the cable

- Use the accessory piping kit or the pipes purchased locally.
- Measure the distance between the indoor and the outdoor unit.
- Cut the pipes a little longer than measured distance.
- Cut the cable 1.5m longer than the pipe length.

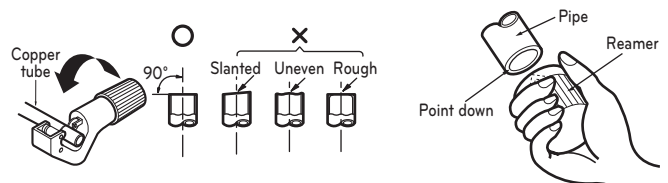

**Burrs removal**

- Completely remove all burrs from the cut cross section of pipe/tube.
- Put the end of the copper tube/pipe to downward direction as you remove burrs in order to avoid to let burrs drop in the tubing.

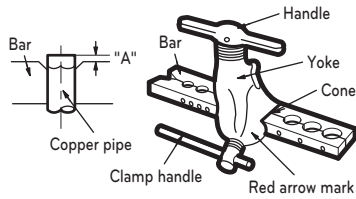

**Flaring work**

- Carry out flaring work using flaring tool as shown below.

Indoor unit [kW(Btu/h)]	Pipe		" A "	
	Gas	Liquid	Gas	Liquid
<5.6(19,100)	1/2"	1/4"	0.5~0.8	0~0.5
<16.0(54,600)	5/8"	3/8"	0.8~1.0	0.5~0.8
<22.4(76,400)	3/4"	3/8"	1.0~1.3	0.5~0.8

Firmly hold copper tube in a bar(or die) as indicated dimension in the table above.

**Check**

- Compare the flared work with figure below.
- If flare is noted to be defective, cut off the flared section and do flaring work again.

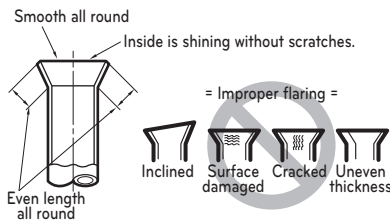

**Flare shape and flare nut tightening torque**

**Precautions when connecting pipes**

- See the following table for flare part machining dimensions.
- When connecting the flare nuts, apply refrigerant oil to the inside and outside of the flares and turn them three or four times at first. (Use ester oil or ether oil.)
- See the following table for tightening torque.(Applying too much torque may cause the flares to crack.)
- After all the piping has been connected, use nitrogen to perform a gas leak check.

Pipe size	Tightening torque(N cm)	A(mm)	Flare shape
Ø9.52	38±4	12.8-13.2	
Ø12.7	55±6	16.2-16.6	
Ø15.88	75±7	19.3-19.7	

**CAUTION**

- Always use a charge hose for service port connection.
- After tightening the cap, check that no refrigerant leaks are present.
- When loosening a flare nut, always use two wrenches in combination, When connecting the piping, always use a spanner and torque wrench in combination to tighten the flare nut.
- When connecting a flare nut, coat the flare(inner and outer faces) with oil for R410A(PVE) and hand tighten the nut 3 to 4 turns as the initial tightening.

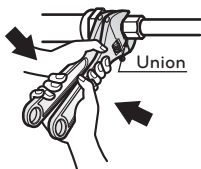

**Opening shutoff valve**

- 1 Remove the cap and turn the valve counter clockwise with the hexagon wrench.
- 2 Turn it until the shaft stops.  
Do not apply excessive force to the shutoff valve. Doing so may break the valve body, as the valve is not a backseat type. Always use the special tool.
- 3 Make sure to tighten the cap securely.

**Closing shutoff valve**

- 1 Remove the cap and turn the valve clockwise with the hexagon wrench.
- 2 Securely tighten the valve until the shaft contacts the main body seal.
- 3 Make sure to tighten the cap securely.  
\* For the tightening torque, refer to the table on the below.

**Tightening torque**

Shutoff valve size	Tightening torque N·m(Turn clockwise to close)						
	Shaft (valve body)			Cap (Valve lid)	Service port	Flare nut	Gas line piping attached to unit
	Closed	Opened	Hexagonal wrench				
Ø6.35	6.0±0.6	5.0±0.0	4mm	17.6±2.0	12.7±2	16±2	
Ø9.52							
Ø12.7	10.0±1.0	5.0±0.0	5mm	25.0±2.5	12.7±2	55±6	
Ø15.88	12.0±1.2					75±7	
Ø19.05	14.0±1.4	5.0±0.0	8mm	25.0±2.5	12.7±2	110±10	
Ø22.2	30.0±3.0						
Ø25.4							25±3

**Insulation of shutoff valve**

- 1 Use the heat insulation material for the refrigerant piping which has an excellent heat-resistance (over 120°C).
- 2 Precautions in high humidity circumstance:  
This air conditioner has been tested according to the "ISO Conditions with Mist" and confirmed that there is not any default. However, if it is operated for a long time in high humid atmosphere (dew point temperature: more than 23°C), water drops are liable to fall. In this case, add heat insulation material according to the following procedure:
  - Heat insulation material to be prepared... EPDM (Ethylene Propylene Diene Methylene)-over 120°C the heat-resistance temperature.
  - Add the insulation over 10mm thickness at high humidity environment.

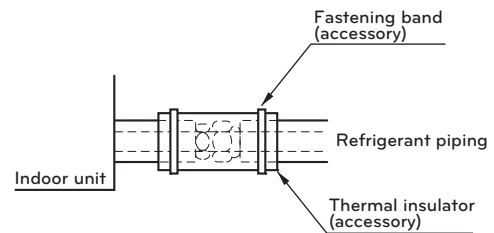

### Plumbing materials and storage methods

Pipe must be able to obtain the specified thickness and should be used with low impurities.  
 Also when handling storage, pipe must be careful to prevent a fracture, deformity and wound.  
 Should not be mixed with contaminations such as dust, moisture.

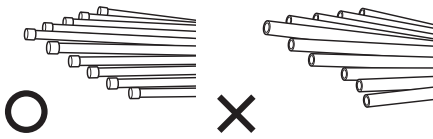

### Refrigerant piping on three principles

	Drying	Cleanliness	Airtight
	Should be no moisture inside	No dust inside.	There is no refrigerant leakage
Items			
Cause failure	<ul style="list-style-type: none"> <li>- Significant hydrolysis of refrigerant oil</li> <li>- Degradation of refrigerant oil</li> <li>- Poor insulation of the compressor</li> <li>- Do not cold and warm</li> <li>- Clogging of EEV, Capillary</li> </ul>	<ul style="list-style-type: none"> <li>- Degradation of refrigerant oil</li> <li>- Poor insulation of the compressor</li> <li>- Do not cold and warm</li> <li>- Clogging of EEV, Capillary</li> </ul>	<ul style="list-style-type: none"> <li>- Gas shortages</li> <li>- Degradation of refrigerant oil</li> <li>- Poor insulation of the compressor</li> <li>- Do not cold and warm</li> </ul>
Countermeasure	<ul style="list-style-type: none"> <li>- No moisture in the pipe</li> <li>- Until the connection is completed, the plumbing pipe entrance should be strictly controlled.</li> <li>- Stop plumbing at rainy day.</li> <li>- Pipe entrance should be taken side or bottom.</li> <li>- When removal burr after cutting pipe, pipe entrance should be taken down.</li> <li>- Pipe entrance should be fitted cap when pass through the walls.</li> </ul>	<ul style="list-style-type: none"> <li>- No dust in the pipe.</li> <li>- Until the connection is completed, the plumbing pipe entrance should be strictly controlled.</li> <li>- Pipe entrance should be taken side or bottom.</li> <li>- When removal burr after cutting pipe, pipe entrance should be taken down.</li> <li>- Pipe entrance should be fitted cap when pass through the walls.</li> </ul>	<ul style="list-style-type: none"> <li>- Airtightness test should be.</li> <li>- Brazing operations to comply with standards.</li> <li>- Flare to comply with standards.</li> <li>- Flange connections to comply with standards.</li> </ul>

### Nitrogen substitution method

Welding, as when heating without nitrogen substitution a large amount of the oxide film is formed on the internal piping.  
 The oxide film is a caused by clogging EEV, Capillary, oil hole of accumulator and suction hole of oil pump in compressor.  
 It prevents normal operation of the compressor.  
 In order to avoid this problem, Welding should be done after replacing air by nitrogen gas.  
 When welding plumbing pipe, the work is required.

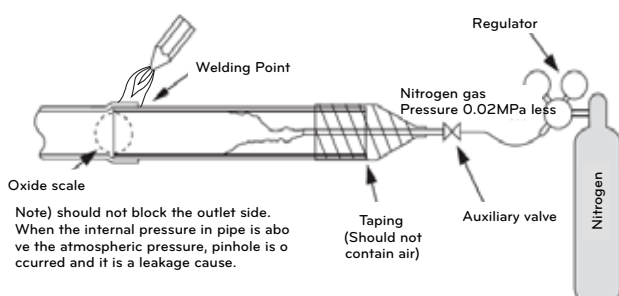

### CAUTION

- Always use the nitrogen.(not use oxygen, carbon dioxide, and a Chevron gas): Please use the following nitrogen pressure 0.02MPa Oxygen - Promotes oxidative degradation of refrigerant oil. Because it is flammable, it is strictly prohibited to use Carbon dioxide - Degrade the drying characteristics of gas Chevron Gas - Toxic gas occurs when exposed to direct flame.
- Always use a pressure reducing valve.
- Please do not use commercially available antioxidant. The residual material seems to be the oxide scale is observed. In fact, due to the organic acids generated by oxidation of the alcohol contained in the anti-oxidants, ants nest corrosion occurs. (causes of organic acid alcohol + copper + water + temperature)

## REFRIGERANT PIPING INSTALLATION

### Precautions on Pipe connection / Valve operation

Pipe connection is done by connecting from the end of the pipe to the branching pipes, and the refrigerant pipe coming out of the outdoor unit is divided at the end to connect to each indoor unit. Flare connection for the indoor unit, and welding connection for the outdoor pipe and the branching parts.

- Use hexagonal wrench to open/close the valve.

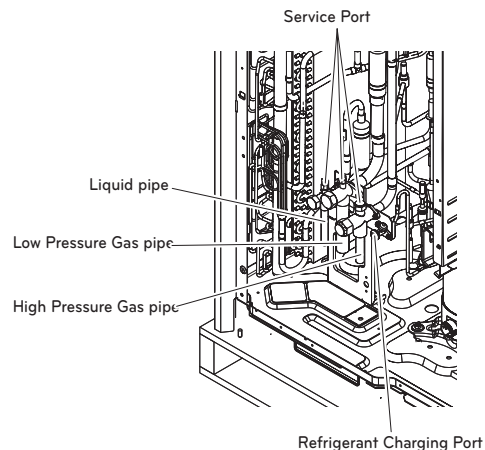

### WARNING

- Always careful not to leak the refrigerant during welding.
- The refrigerant generates poisonous gas harmful to human body if combusted.
- Do not perform welding in a closed space.
- Be sure to close the cap of the service port to prevent gas leakage after the work.

### CAUTION

Please block the pipe knock outs of the front and side panels after installing the pipes.  
 (Animals or foreign objects may be brought in to damage wires.)

## Connection of Outdoor units

### 2, 3, 4 Outdoor Units

Outdoor units	Model	Low Pressure Gas Pipe	Liquid Pipe	High Pressure Gas Pipe
2 Unit	© ARCNB21			
3 Unit	© ARCNB31			
4 Unit	© ARCNB41			

For more information, refer accessory installation manual.

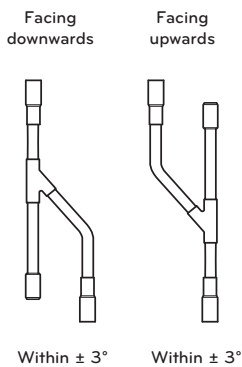
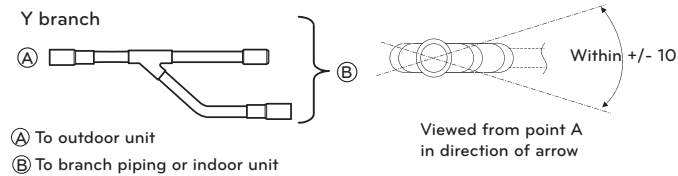

### Installation procedure for HR unit

- Using an insert-hole-in-anchor, hang the hanging bolt.
- Install a hexagon nut and a flat washer (locally-procured) to the hanging bolt as shown in the figure in the bottom, and fit the main unit to hang on the hanger metal.
- After checking with a level that the unit is level, tighten the hexagon nut.  
\* The tilt of the unit should be within ±5° in front/back and left/right.
- This unit should be installed suspended from ceiling and side A should always be facing up.
- Insulate not used pipes completely as shown in the figure.

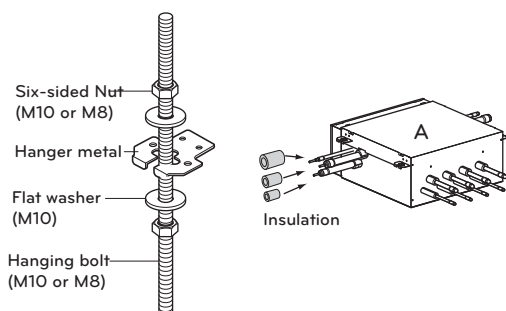

## Installation of Outdoor Unit, HR Unit, Indoor Unit Refrigerant Pipe

3 pipes are connected to the HR unit from the outdoor unit, classified into liquid pipe, low pressure gas pipe and high pressure gas pipe depending on status of refrigerant passing through the pipe.

You must connect 3 pipes from outdoor unit to HR unit.

For connection between indoor unit and HR unit, you must connect both liquid pipe and gas pipe from the HR unit to the indoor unit. In this case, connect them to the indoor unit starting from No.1 connection port of the HR unit (the port number is displayed on ports of the HR unit). Use auxiliary flare as annexed parts in connection to the indoor unit.

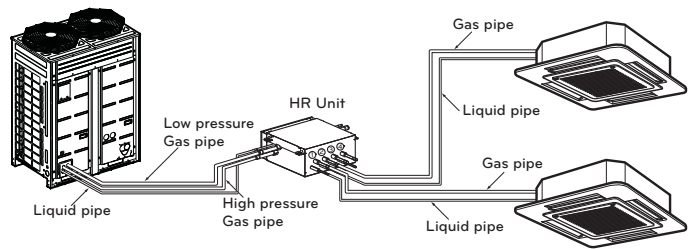

### CAUTION

Whenever connecting the indoor units with the HR unit, install the indoor units in numerical order from No.1.

Ex) In case of installing 3 indoor units : No. 1, 2, 3 (O), No. 1, 2, 4 (X), No.1, 3, 4 (X), No.2, 3, 4 (X).

### Type of HR Unit

Select an HR unit according to the number of the indoor units to be installed. HR units are classified into 3 types by the number of connectable indoor units.

Ex) Installation of 6 indoor units

Consists of HR unit for 4 branches and HR unit for 2 branches.

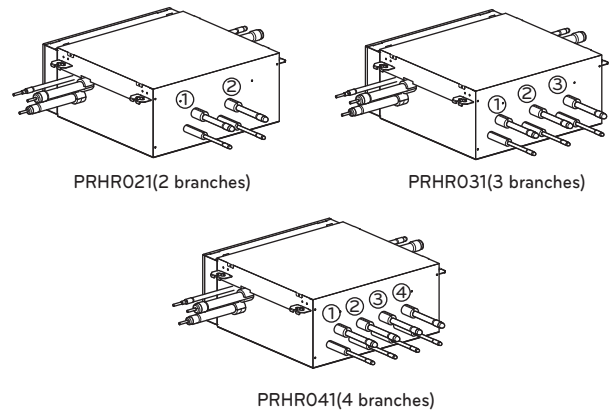

### Joint Method of HR Unit (Big Duct : ARNU76GB8-, ARNU96GB8-)

Joint Method is required when B5/B8 chassis is installed. In Joint Method, two neighboring outlets of one HR unit are linked by Y branch pipe and connected to one indoor unit.

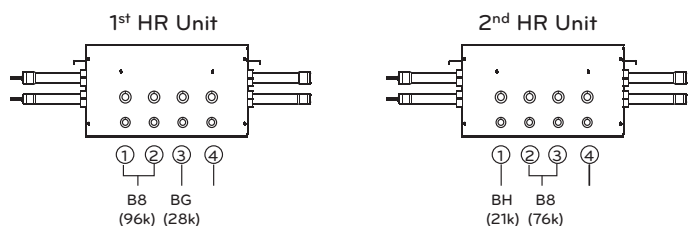

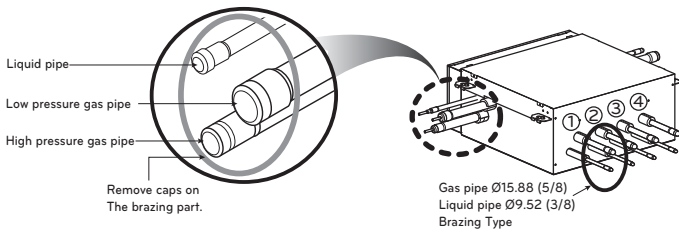

HR unit	PRHR021	PRHR031	PRHR041
Low pressure gas pipe	Ø22.2	Ø28.58	Ø28.58
High pressure gas pipe	Ø19.05	Ø22.2	Ø22.2
Liquid pipe	Ø9.52	Ø12.7	Ø15.88

### Installation of Zoning Control

Some indoor unit can be connected to one port of HR unit.

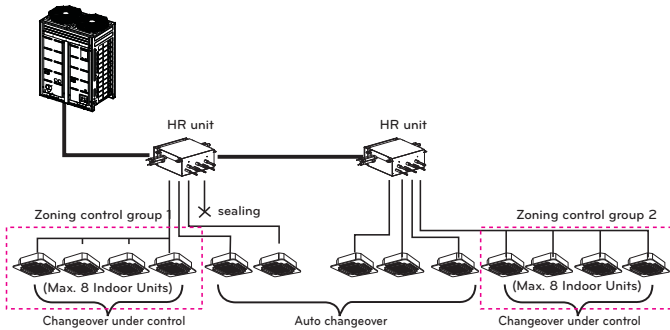

#### WARNING

- A branch pipe of HR unit allows up to 14.1kW based on cooling capacity of the indoor unit. (up to 14.1kW (48kBtu/h) for max installation)
- The maximum total capacity of indoor units connected to a PRHR041 HR unit is 56.4kW (192 kBtu/h).
- The maximum number of indoor units connected to a PRHR041 HR unit are 32 indoor units. (The Maximum indoor units per a branch pipe of HR unit are 8 indoor units)
- There is not operate "Auto-changeover" & "Mode override" function in the zoning group.
- When there are operating indoor units on cooling(heating) mode, another indoor units aren't changed on heating(cooling) mode in the zoning group.

### [Reducers for indoor unit and HR unit]

(Unit : mm)

Models	Liquid pipe	Gas pipe	
		High pressure	Low pressure
Indoor unit reducer	Ø9.52(3/8) Ø6.35(1/4)	-	Ø15.88(5/8) Ø12.7(1/2)
PRHR021A	Ø9.52(3/8) Ø6.35(1/4)	Ø19.05(3/4) Ø15.88(5/8) Ø12.7(1/2)	Ø22.2(7/8) Ø19.05(3/4) Ø15.88(5/8)
		Ø12.7(1/2) Ø9.52(3/8)	Ø15.88(5/8) Ø12.7(1/2)
HR unit reducer	Ø15.88(5/8) Ø12.7(1/2) Ø9.52(3/8)	Ø22.2(7/8) Ø19.05(3/4) Ø15.88(5/8)	Ø28.58(1-1/8) Ø22.2(7/8) Ø19.05(3/4)
		Ø15.88(5/8) Ø12.7(1/2)	Ø19.05(3/4) Ø15.88(5/8)

### Caution

- 1 Use the following materials for refrigerant piping.
  - Material: Seamless phosphorous deoxidized copper pipe
  - Wall thickness : Comply with the relevant local and national regulations for the designed pressure 3.8MPa. We recommend the following table as the minimum wall thickness.

Outer diameter [mm]	6.35	9.52	12.7	15.88	19.05	22.2	25.4	28.58	31.8	34.9	38.1	41.3	44.45	53.98
Minimum thickness [mm]	0.8	0.8	0.8	0.99	0.99	0.99	0.99	0.99	1.1	1.21	1.35	1.43	1.55	2.1

- 2 Commercially available piping often contains dust and other materials. Always blow it clean with a dry inert gas.
- 3 Use care to prevent dust, water or other contaminants from entering the piping during installation.
- 4 Reduce the number of bending portions as much as possible, and make bending radius as big as possible.
- 5 Always use the branch piping set shown below, which are sold separately.

Y branch	Header		
	4 branch	7 branch	10 branch
ARBLB01621, ARBLB03321, ARBLB07121, ARBLB14521, ARBLB23220	ARBL054	ARBL057	ARBL1010
	ARBL104	ARBL107	ARBL2010

- 6 If the diameters of the branch piping of the designated refrigerant piping differs, use a pipe cutter to cut the connecting section and then use an adapter for connecting different diameters to connect the piping.
- 7 Always observe the restrictions on the refrigerant piping (such as rated length, difference in height, and piping diameter). Failure to do so can result in equipment failure or a decline in heating/cooling performance.
- 8 A second branch cannot be made after a header. (These are shown by ⊘.)

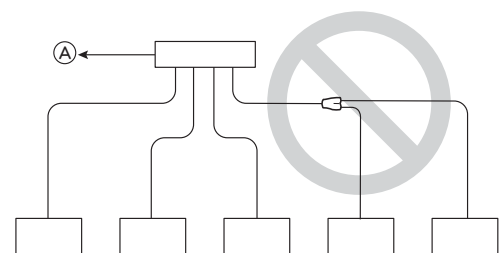

- (A) To Outdoor Unit
- (B) Sealed Piping

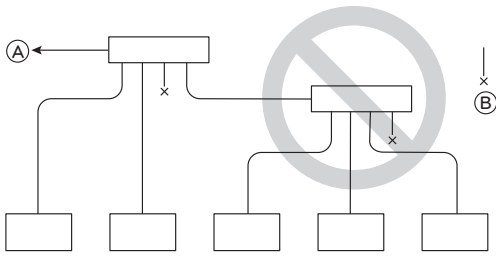

- 9 The Multi V will stop due to an abnormality like excessive or insufficient refrigerant. At such a time, always properly charge the unit. When servicing, always check the notes concerning both the piping length and the amount of additional refrigerant.
- 10 Never perform a pump down. This will not only damage the compressor but also deteriorate the performance.
- 11 Never use refrigerant to perform an air purge. Always evacuate air by using a vacuum pump.
- 12 Always insulate the piping properly. Insufficient insulation will result in a decline in heating/cooling performance, drip of condensate and other such problems.
- 13 When connecting the refrigerant piping, make sure the service valves of the Outdoor Unit is completely closed (the factory setting) and do not operate it until the refrigerant piping for the Outdoor and Indoor Units has been connected, a refrigerant leakage test has been performed and the evacuation process has been completed.
- 14 Always use a non-oxidizing brazing material for brazing the parts and do not use flux. If not, oxidized film can cause clogging or damage to the compressor unit and flux can harm the copper piping or refrigerant oil.

### WARNING

When installing and moving the air conditioner to another site, be sure to make recharge refrigerant after perfect evacuation.

- If a different refrigerant or air is mixed with the original refrigerant, the refrigerant cycle may malfunction and the unit may be damaged.
- After selecting diameter of the refrigerant pipe to suit total capacity of the indoor unit connected after branching, use an appropriate branch pipe set according to the pipe diameter of the indoor unit and the installation pipe drawing.

## PIPE CONNECTIONS BETWEEN INDOOR AND OUTDOOR UNIT

- Pipe connections can be done on the front side or on the side according to the installation environments.
- Be sure to let 0.2kgf/cm<sup>2</sup> Nitrogen flow in the pipe when welding.
- If Nitrogen was not flown during welding, many oxidized membranes may form inside the pipe and disturb the normal operations of valves and condensers.

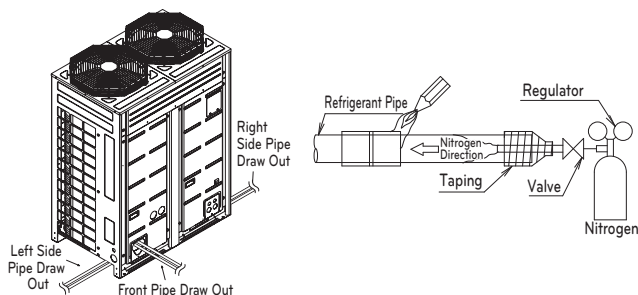

## Preparation Work

- Use Knock Outs of Base Pan of the outdoor unit for Left/Right or Bottom pipe drawing outs.

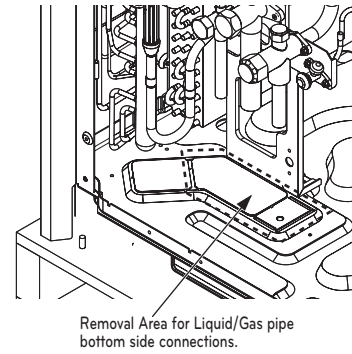

### CAUTION

- Do not give damage to the pipe/base during the Knock Out work.
- Proceed to pipe work after removing burr after Knock Out work.
- Perform sleeve work to prevent damage to the wire when connecting wires using knock Outs.

### Remove leakage prevention cap

- Remove the leakage prevention cap attached to the outdoor unit service valve before pipe work.
- Proceed the leakage prevention cap removal as follows:
  - Verify whether the liquid/gas pipes are locked.
  - Extract remaining refrigerant or air inside using the service port.
  - Remove the leakage prevention cap

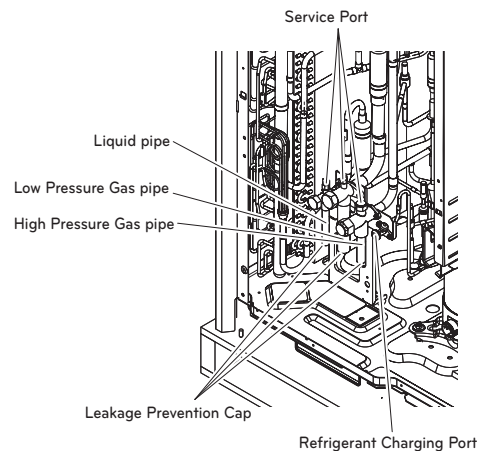

## Pipe Drawing Out during Single / Series connection

### Method of drawing out pipes on the front side

- Proceed with the pipe work as shown in the below figure for front side pipe drawing out.

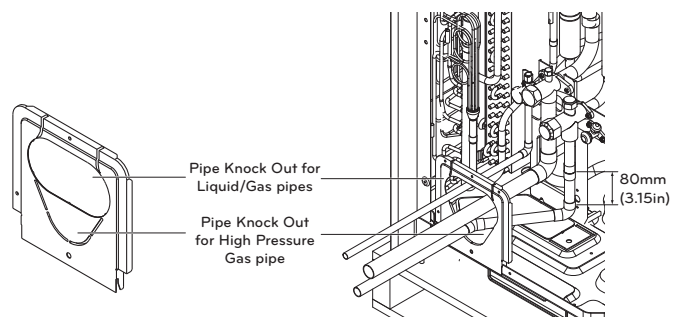

**Method of drawing out pipes on the bottom side**

- Drawing out common pipe through side panel

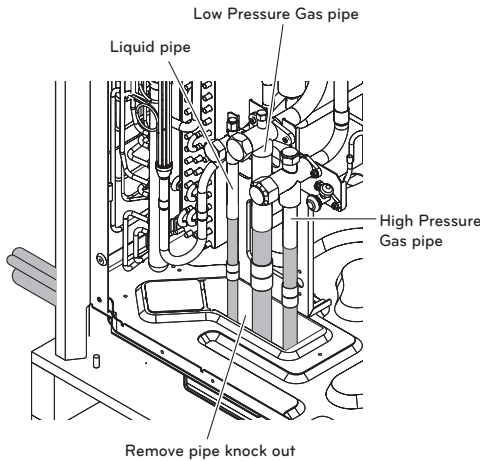

**Refrigerant piping system**

**4 Outdoor Units**

Example : 12 Indoor Units connected

- Ⓐ : Outdoor Unit
- Ⓑ : Y branch
- Ⓓ : Indoor Unit
- Ⓔ : Connection branch pipe between Outdoor units : ARCNB41
- Ⓕ : Connection branch pipe between Outdoor units : ARCNB31
- Ⓖ : Connection branch pipe between Outdoor units : ARCNB21
- Ⓗ : Header
- Ⓙ : HR Unit

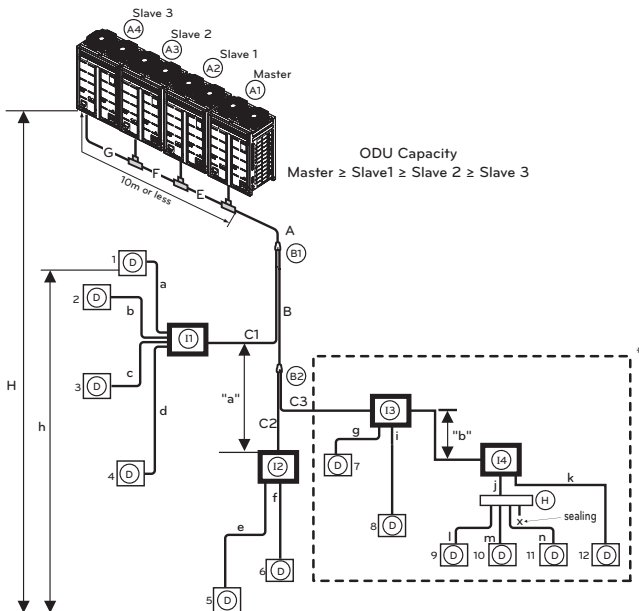

- Case 1 ("a") : Maximum height is 15m if you install with Y branch.
- Case 2 ("b") : Maximum height is 5m in serial connection of HR units.

**Conditional**

To satisfy below condition to make 40 m ~ 90 m of pipe length after first branch.

- 1 Diameter of pipes between first branch and the last branch should be increased by one step, except pipe diameter B,C3 is same as Diameter A  
 $\varnothing 6.35' \varnothing 9.52' \varnothing 12.7' \varnothing 15.88' \varnothing 19.05' \varnothing 22.2' \varnothing 25.4' \varnothing 28.58' \varnothing 31.8' \varnothing 34.9' \varnothing 38.1'$   
 \* : It is not necessary to size up.
- 2 While calculating whole refrigerant pipe length, pipe B,C3 length should be calculated twice.  
 $A + B \times 2 + C3 \times 2 + C1 + C2 + a + b + c + d + e + f + g + i + j + k + l + m + n \leq 1,000 \text{ m}$

- 3 Length of pipe from each indoor unit to the HR Unit  
 $(a,b,c,d,e,f,g,i,j,k,l,m,n) \leq 40 \text{ m}$
- 4 [Length of pipe from outdoor unit to the farthest indoor unit D12  
 $(A+B+C+D+e)$   
 - [Length of pipe outdoor unit to the closest indoor unit D1(C1+a)]  $\leq 40 \text{ m}$

**Refrigerant pipe diameter from branch to branch (B,C,D)**

**! WARNING**

- \* : Serial connection of HR units : Capacity sum of indoor units 192.4 kBTU/hr
- Refer to the HR unit PCB part for the valve group control setting.
- It is recommended that difference in pipe lengths between an HR unit and indoor units, for example difference in length of a, b, c, and d, be minimized. The larger difference in pipe lengths, the more different performance between indoor units.
- Piping length from outdoor branch to outdoor unit  $\leq 10\text{m}$ , equivalent length : max 13m (for 22HP or more)
- \* If the large capacity indoor units (Over 5 HP; using over  $\varnothing 15.88/\varnothing 9.52$ ) are installed, it should be used the Valve Group setting

**Refrigerant pipe diameter from branch to branch (B,C)**

Downward indoor unit total capacity [kW(Btu/h)]	Liquid pipe [mm(inch)]	Gas pipe [mm(inch)]	
		Low pressure	High pressure
$\leq 5.6(19,100)$	$\varnothing 6.35(1/4)$	$\varnothing 12.7(1/2)$	$\varnothing 9.52(3/8)$
$< 16.0(54,600)$	$\varnothing 9.52(3/8)$	$\varnothing 15.88(5/8)$	$\varnothing 12.7(1/2)$
$< 22.4(76,400)$	$\varnothing 9.52(3/8)$	$\varnothing 19.05(3/4)$	$\varnothing 15.88(5/8)$
$< 33.6(114,700)$	$\varnothing 9.52(3/8)$	$\varnothing 22.2(7/8)$	$\varnothing 19.05(3/4)$
$< 50.4(229,000)$	$\varnothing 12.7(1/2)$	$\varnothing 28.58(1\ 1/8)$	$\varnothing 22.2(7/8)$
$< 61.6(210,600)$	$\varnothing 15.88(5/8)$	$\varnothing 28.58(1\ 1/8)$	$\varnothing 22.2(7/8)$
$< 72.8(210,600)$	$\varnothing 15.88(5/8)$	$\varnothing 34.9(1\ 3/8)$	$\varnothing 28.58(1\ 1/8)$
$< 100.8(344,000)$	$\varnothing 19.05(3/4)$	$\varnothing 34.9(1\ 3/8)$	$\varnothing 28.58(1\ 1/8)$
$< 173.6(592,500)$	$\varnothing 19.05(3/4)$	$\varnothing 41.3(1\ 5/8)$	$\varnothing 34.9(1\ 3/8)$
$< 184.8(630,700)$	$\varnothing 22.2(7/8)$	$\varnothing 44.5(1\ 3/4)$	$\varnothing 41.3(1\ 5/8)$
$\leq 224.0(764,400)$	$\varnothing 22.2(7/8)$	$\varnothing 53.98(2\ 1/8)$	$\varnothing 44.5(1\ 3/4)$

**Total pipe length = A + B + C1 + C2 + C3 + a + b + c + d + e + f + g + i + j + k + l + m + n  $\leq 1,000\text{m}$**

L	Longest pipe length	* Equivalent pipe length
L	$A+B+C3+D+k \leq 150\text{m}(200\text{m}^{**})$	$A+B+C3+D+k \leq 175\text{m}(225\text{m}^{**})$
l	Longest pipe length after 1st branch $B+C3+D+k \leq 40\text{m}(90\text{m}^{**})$	
H	Difference in height(Outdoor Unit ↔ Indoor Unit)	$H \leq 110\text{m}$
h	Difference in height (Indoor Unit ↔ Indoor Unit)	$h \leq 40\text{m}$
h1	Difference in height (Outdoor Unit ↔ Outdoor Unit)	$h1 \leq 5\text{m}$
"a", "b"	Difference in height(HR unit ↔ HR unit)	$a \leq 15\text{m}, b \leq 5\text{m}$

- \* : Assume equivalent pipe length of Y branch to be 0.5m, that of header to be 1m, calculation purpose
- It is recommended that indoor unit is installed at lower position than the header.
- \*\* : To apply conditional application.

**! WARNING**

When the equivalent length between a outdoor and the farthest indoor unit is 90m or more, main pipe(A) must be increased one grade.

**Refrigerant pipe diameter from outdoor unit to first branch. (A)**

Upward outdoor unit total capacity	Pipe diameter			Pipe diameter when pipe length is 90m over to 1st branch		
	HP	Liquid mm(inch)	Low pressure gas pipe mm(inch)	High pressure gas pipe mm(inch)	Liquid mm(inch)	Low pressure gas pipe mm(inch)
8	9.52(3/8)	19.05(3/4) 22.2(7/8)	15.88(5/8)	12.7(1/2)	22.2(7/8) 25.4(1)	19.05(3/4)
10			19.05(3/4)			
12			19.05(3/4)			
14	12.7(1/2)	28.58(1-1/8)	22.2(7/8)	15.88(5/8)	31.8(1-1/4)	25.4(1)
16						
18						
20						
22	15.88(5/8)	34.9(1-3/8)	28.58(1-1/8)	19.05(3/4)	38.1(1-1/2)	31.8(1-1/4)
24						
26						
28						
30						
32						
34						
36						
38						
40						
42	19.05(3/4)	41.3(1-5/8)	34.9(1-3/8)	22.2(7/8)	44.5(1-3/4)	38.1(1-1/2)
44						
46						
48						
50						
52						
54						
56						
58						
60	22.2(7/8)	53.98(2-1/8)	44.5(1-3/4)	25.4(1)	53.98(2-1/8)	44.5(1-3/4)
62						
64						
66						
68						
70						
72						
74						
76						
78						
80						

\* If available on site, it use this size. Otherwise it can't be increased.

**Y branch, Header and HR unit connection pattern**

Pattern 1

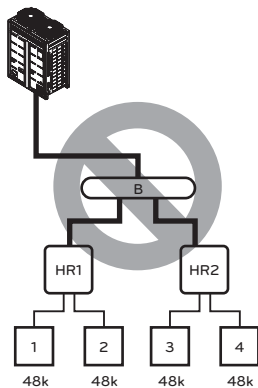

• Impossible installation : Head branch pipe → HR unit

Pattern 2

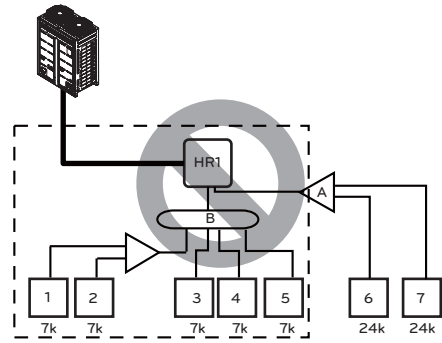

• Impossible installation : HR unit → Head branch pipe → Y and Head branch pipe.

Pattern 3

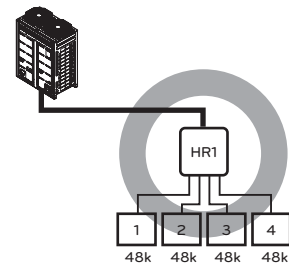

• The maximum total capacity of indoor units is 56.4kW(192 kBTu/h).

Pattern 4

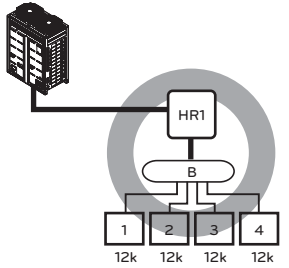

• The maximum total capacity of a branch pipe of HR unit is 14.1kW(48 kBTu/h).

Pattern 5

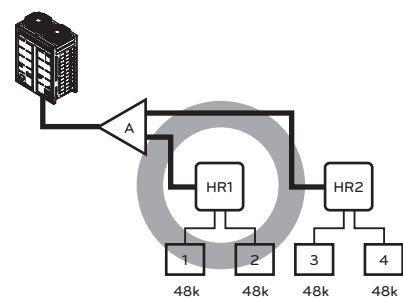

Pattern 6

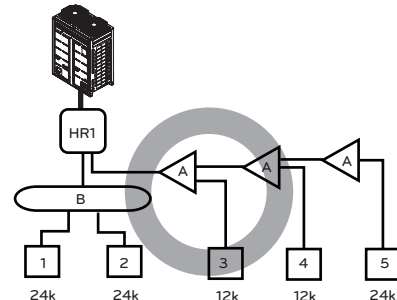



**Pipe Connection Method/Precautions for Series connections between Outdoor units**

- Separate Y branch joints are needed for series connections between outdoor units.
- Please refer to the below connection examples to install pipe connections between outdoor units.

**Pipe connection between outdoor units (General Case)**

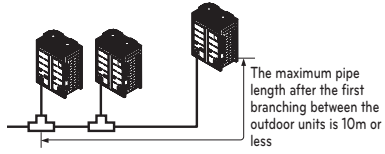

**Pipes between outdoor units are 2m or less**

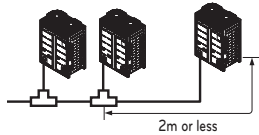

**Pipes between outdoor units are 2m or longer**

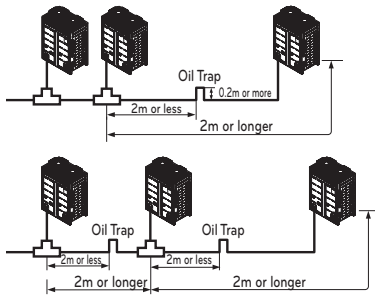

- If the distance between the outdoor units becomes more than 2m, apply Oil Traps between the gas pipes.
- If the outdoor unit is located lower than the main pipe, apply Oil Trap.

**Examples of Wrong Pipe Connections**

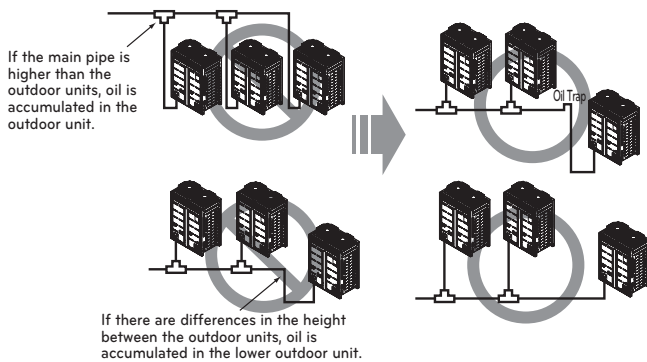

(Example 1)



(Example 2)

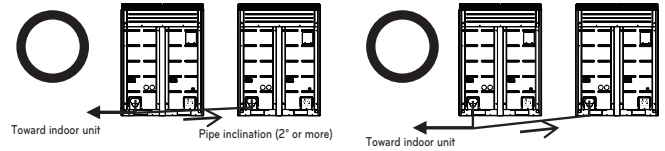

(Example 3)



- Apply Oil Trap as shown below when the length of the pipe between the outdoor units is more than 2m. Otherwise, the unit may not operate properly.

(Example 1)

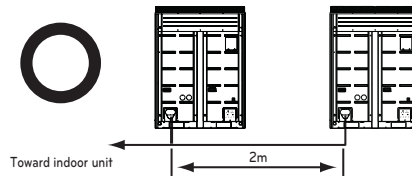

(Example 2)

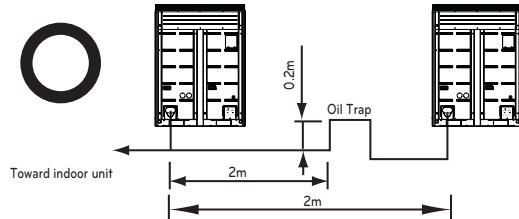

- When connecting the pipes between the outdoor units, the accumulation of oil in the slave outdoor unit should be avoided. Otherwise, the unit may not operate properly.

(Example 1)



(Example 2)

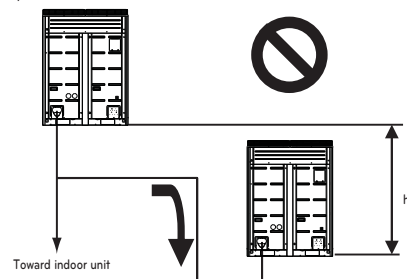

(Example 3)

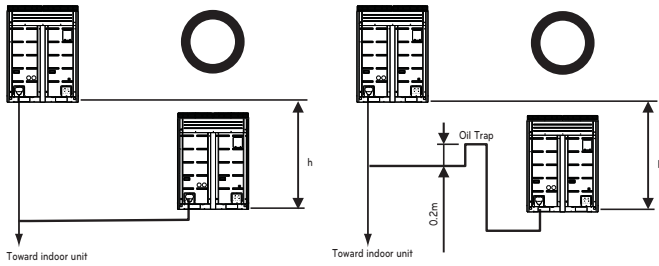

### The amount of Refrigerant

The calculation of the additional charge should take into account the length of pipe and CF(correction Factor) value of indoor unit.

Additional charge(kg)	=	Total liquid pipe : Ø25.4 mm	x 0.480(kg/m)
	+	Total liquid pipe : Ø22.2 mm	x 0.354(kg/m)
	+	Total liquid pipe : Ø19.05 mm	x 0.266(kg/m)
	+	Total liquid pipe : Ø15.88 mm	x 0.173(kg/m)
	+	Total liquid pipe : Ø12.7 mm	x 0.118(kg/m)
	+	Total liquid pipe : Ø9.52 mm	x 0.061(kg/m)
	+	Total liquid pipe : Ø6.35 mm	x 0.022(kg/m)
	+	Number of installed HR units	x 0.5(kg/m)
		CF value of indoor unit	

Amount refrigerant of Indoor units

Example) 4Way Ceiling Cassette 14.5kW -1ea, Ceiling concealed  
 Duct 7.3kW-2ea,  
 Wall Mounted 2.3kW-4ea  
 $CF = 0.64 \times 1 + 0.26 \times 2 + 0.24 \times 4 = 2.12 \text{ kg}$

Attach the additional refrigerant table of IDU.

### ! WARNING

- Regulation for refrigerant leakage : the amount of refrigerant leakage should satisfy the following equation for human safety.

$$\frac{\text{Total amount of refrigerant in the system}}{\text{Volume of the room at which Indoor Unit of the least capacity is installed}} \leq 0.44 \text{ (kg/m}^3\text{)}$$

If the above equation can not be satisfied, then follow the following steps.

- Selection of air conditioning system: select one of the next
  - Installation of effective opening part
  - Reconfirmation of Outdoor Unit capacity and piping length
  - Reduction of the amount of refrigerant
  - Installation of 2 or more security device (alarm for gas leakage)
- Change Indoor Unit type : installation position should be over 2m from the floor (Wall mounted type → Cassette type)
- Adoption of ventilation system : choose ordinary ventilation system or building ventilation system
- Limitation in piping work : Prepare for earthquake and thermal stress

### Refrigerant charging

- Ⓐ Manifold Gauge
- Ⓑ Low pressure side Handle
- Ⓒ High pressure side Handle

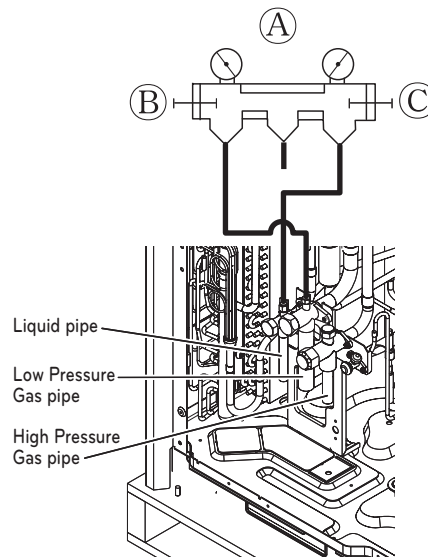

### ! WARNING

- Pipe to be vacuumed : gas pipe, liquid pipe
- If the refrigerant amount is not exact, it may not operate properly.
- If additionally bottled refrigerant amount is over 10%, condenser burst or insufficient indoor unit performance may be caused.

### ! CAUTION

Use only 2-series of indoor unit. Ex) ARNU/H\*\*\*2



## Header

(unit:mm)

Models	Gas pipe	Liquid pipe
4 branch ARBL054		
7 branch ARBL057		
4 branch ARBL104		
7 branch ARBL107		
10 branch ARBL1010		
10 branch ARBL2010		

## Leak Test and Vacuum drying

## Leak test

Leak test should be made by pressurizing nitrogen gas to 3.8 MPa(38.7kgf/cm<sup>2</sup>). If the pressure does not drop for 24 hours, the system passes the test. If the pressure drops, check where the nitrogen leaks. For the test method, refer to the following figure. (Make a test with the service valves closed. Be also sure to pressurize liquid pipe, gas pipe and high pressure gas pipe)

The test result can be judged good if the pressure has not be reduced after leaving for about one day after completion of nitrogen gas pressurization.

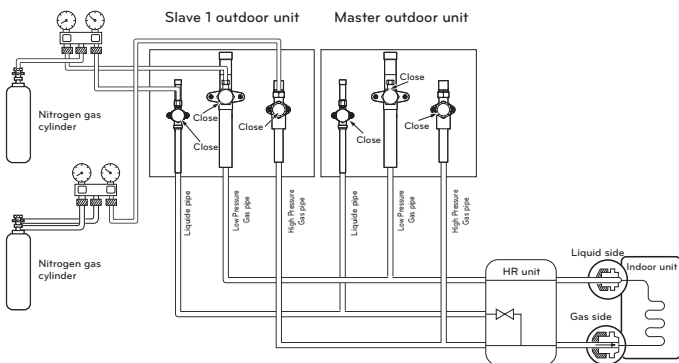

## ! WARNING

Use a vacuum pump or Inert(nitrogen) gas when doing leakage test or air purge. Do not compress air or Oxygen and do not use Flammable gases. Otherwise, it may cause fire or explosion.

- There is the risk of death, injury, fire or explosion.

## ! NOTE

If the ambient temperature differs between the time when pressure is applied and when the pressure drop is checked, apply the following correction factor

There is a pressure change of approximately 0.1 kg/cm<sup>2</sup> (0.01 MPa) for each 1°C of temperature difference.

Correction= (Temp. at the time of pressurization – Temp. at the time of check) X 0.1

For example: Temperature at the time of pressurization (3.8 MPa) is 27 °C

24 hour later: 3.73 MPa, 20°C

In this case the pressure drop of 0.07 is because of temperature drop And hence there is no leakage in pipe occurred.

## ! CAUTION

To prevent the nitrogen from entering the refrigeration system in the liquid state, the top of the cylinder must be at higher position than the bottom when you pressurize the system.

Usually the cylinder is used in a vertical standing position.

## Vacuum

Vacuum drying should be made from the service port provided on the outdoor unit's service valve to the vacuum pump commonly used for Liquid pipe, Low Pressure Gas pipes, High Pressure Gas pipe. (Make Vacuum from Liquid pipe, Low Pressure Gas pipes, High Pressure Gas pipe with the service valve closed.)

\* Never perform air purging using refrigerant.

• Vacuum drying: Use a vacuum pump that can evacuate to -100.7kPa (5 Torr, -755mmHg).

- Evacuate the system from the liquid and gas pipes with a vacuum pump for over 2 hrs and bring the system to -100.7kPa. After maintaining system under that condition for over 1 hr, confirm the vacuum gauge rises. The system may contain moisture or leak.

- Following should be executed if there is a possibility of moisture remaining inside the pipe.  
(Rainwater may enter the pipe during work in the rainy season or over a long period of time)

After evacuating the system for 2 hrs, give pressure to the system to 0.05MPa(vacuum break) with nitrogen gas and then evacuate it again with the vacuum pump for 1hr to -100.7kPa(vacuum drying). If the system cannot be evacuated to -100.7kPa within 2 hrs, repeat the steps of vacuum break and its drying. Finally, check if the vacuum gauge does not rise or not, after maintaining the system in vacuum for 1 hr.

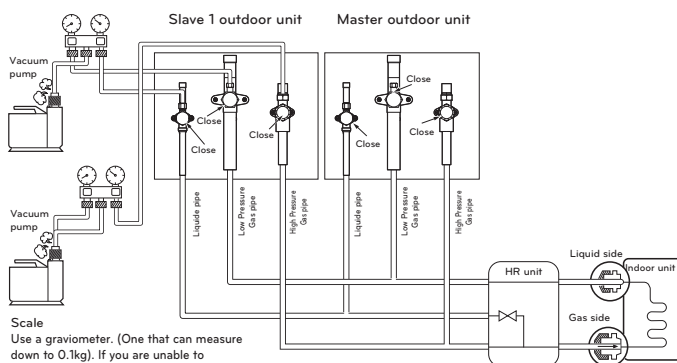

Scale  
Use a gravimeter. (One that can measure down to 0.1kg). If you are unable to prepare such a high-precision gravimeter you may use a charge cylinder.

**! WARNING**

Use a vacuum pump or Inert(nitrogen) gas when doing leakage test or air purge. Do not compress air or Oxygen and do not use Flammable gases. Otherwise, it may cause fire or explosion.  
- There is the risk of death, injury, fire or explosion.

**! NOTE**

Always add an appropriate amount of refrigerant. (For the refrigerant additional charge)  
Too much or too little refrigerant will cause trouble.  
To use the Vacuum Mode (If the Vacuum mode is set, all valves of Indoor units and Outdoor units will be opened.)

**! WARNING**

When installing and moving the air conditioner to another site, recharge after perfect evacuation.  
- If a different refrigerant or air is mixed with the original refrigerant, the refrigerant cycle may malfunction and the unit may be damaged.

**Vacuum Mode**

This function is used for creating vacuum in the system after compressor replacement, ODU parts replacement or IDU addition/replacement.

**Vacuum mode setting method**

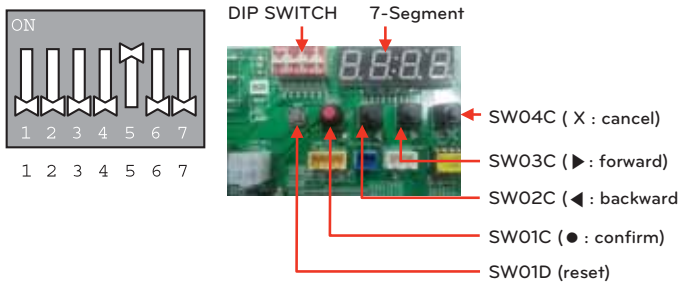

- Master unit PCB DIP switch on : No.5
- Select the mode using '▶', '◀' Button : "SVC" Push the '●' button
- Select the Function using '▶', '◀' Button : "Se3" Push the '●' button
- Start the vacuum mode : "VACC"  
ODU V/V open  
ODU EEV open  
IDU EEV open  
HR unit valve open, SC EEV open

**Vacuum mode off method**

Dip switch off and push the reset button on Master unit PCB

**! CAUTION**

ODU operation stops during vacuum mode. Compressor can't operate.

**Thermal insulation of refrigerant piping**

Be sure to give insulation work to refrigerant piping by covering liquid pipe and gas pipe separately with enough thickness heat-resistant polyethylene, so that no gap is observed in the joint between indoor unit and insulating material, and insulating materials themselves. When insulation work is insufficient, there is a possibility of condensation drip, etc. Pay special attention to insulation work to ceiling plenum.

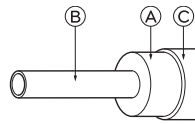

Heat insulation material	Adhesive + Heat - resistant polyethylene foam + Adhesive tape	
Outer covering	Indoor	Vinyl tape
	Floor exposed	Water-proof hemp cloth + Bronze asphalt
	Outdoor	Water-proof hemp cloth + Zinc plate + Oily paint

- Ⓐ Heat insulation material
- Ⓑ Pipe
- Ⓒ Outer covering(Wind the connection part and cutting part of heat insulation material with a finishing tape.)

**! NOTE**

When using polyethylene cover as covering material, asphalt roofing shall not be required.

**Bad example**

- Do not insulate gas or low pressure pipe and liquid or high-pressure pipe together.

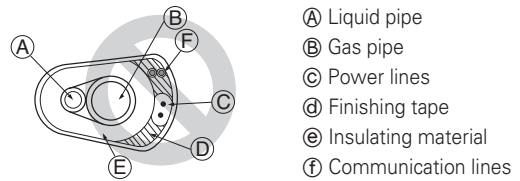

- Be sure to fully insulate connecting portion.

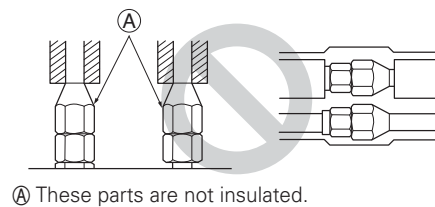

**Good example**

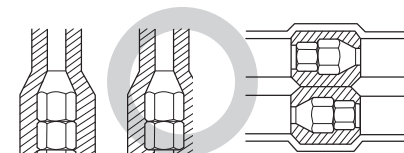
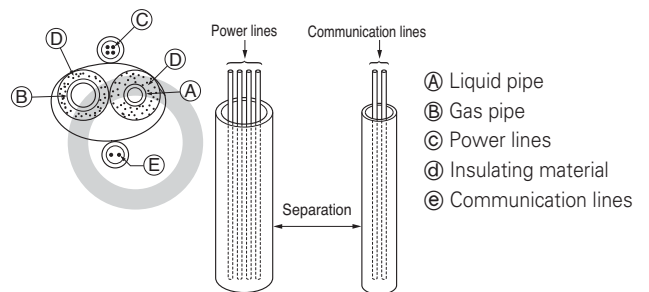

**Penetrations**

Inner wall (concealed)

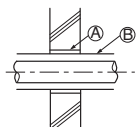

Outer wall

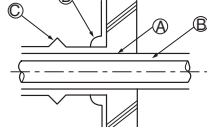

Outer wall (exposed)

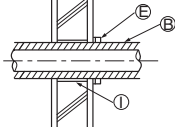

Floor (fireproofing)

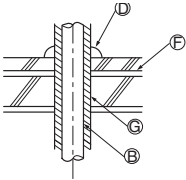

Penetrating portion on fire limit and boundary wall

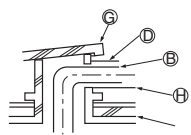

Roof pipe shaft

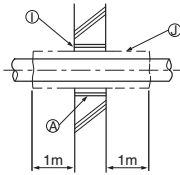

- Ⓐ Sleeve
- Ⓑ Heat insulating material
- Ⓒ Lagging
- Ⓓ Caulking material
- Ⓔ Band
- Ⓕ Waterproofing layer
- Ⓖ Sleeve with edge
- Ⓗ Lagging material
- Ⓘ Mortar or other incombustible caulking
- ⓵ Incombustible heat insulation material

When filling a gap with mortar, cover the penetration part with steel plate so that the insulation material will not be caved in. For this part, use incombustible materials for both insulation and covering. (Vinyl covering should not be used.)

**ELECTRICAL WIRING**

**Caution**

- Follow ordinance of your governmental organization for technical standard related to electrical equipment, wiring regulations and guidance of each electric power company.

**⚠ WARNING**

Be sure to have authorized electrical engineers do the electric work using special circuits in accordance with regulations and this installation manual. If power supply circuit has a lack of capacity or electric work deficiency, it may cause an electric shock or fire.

- Install the Outdoor Unit communication cable away from the power source wiring so that it is not affected by electric noise from the power source. (Do not run it through the same conduit.)

- Be sure to provide designated grounding work to Outdoor Unit.

**⚠ CAUTION**

Be sure to correct the outdoor unit to earth. Do not connect ground wire to any gas pipe, liquid pipe, lightning rod or telephone earth line. If earth is incomplete, it may cause an electric shock.

- Give some allowance to wiring for electrical part box of Indoor and Outdoor Units, because the box is sometimes removed at the time of service work.

- Never connect the main power source to terminal block of communication cable. If connected, electrical parts will be burnt out.

- Use 2-core shield cable for communication cable. (○ mark in the figure below) If communication cable of different systems are wired with the same multiplecore cable, the resultant poor transmitting and receiving will cause erroneous operations. (⊗ mark in the figure below)

- Only the communication cable specified should be connected to the terminal block for Outdoor Unit communication.

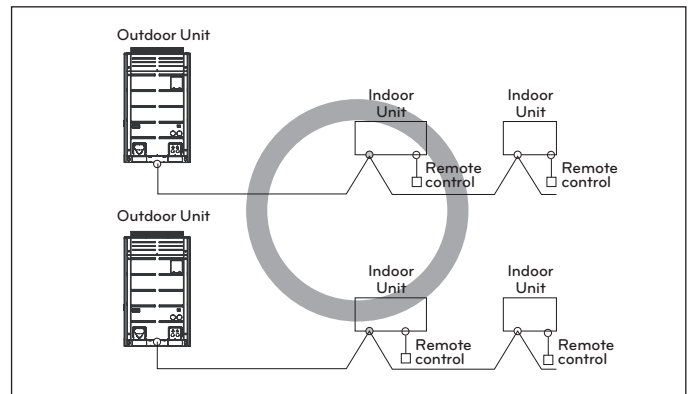

2-Core Shield Cable

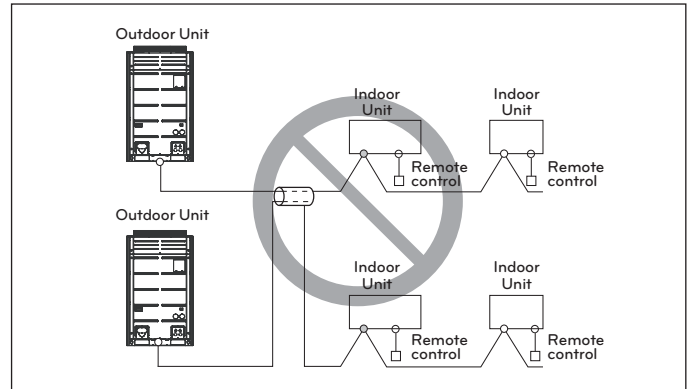

Multi-Core Cable

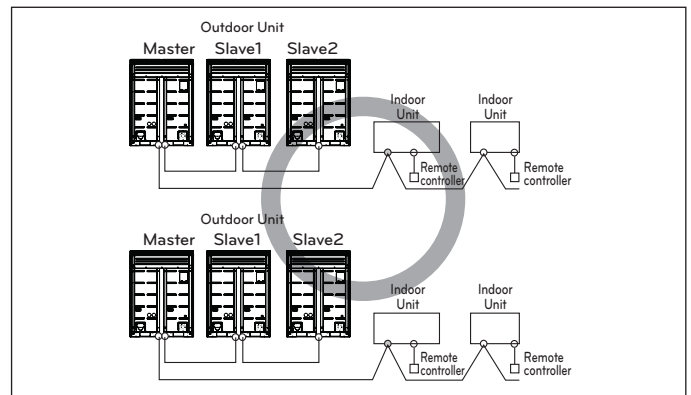

2-Core Shield Cable

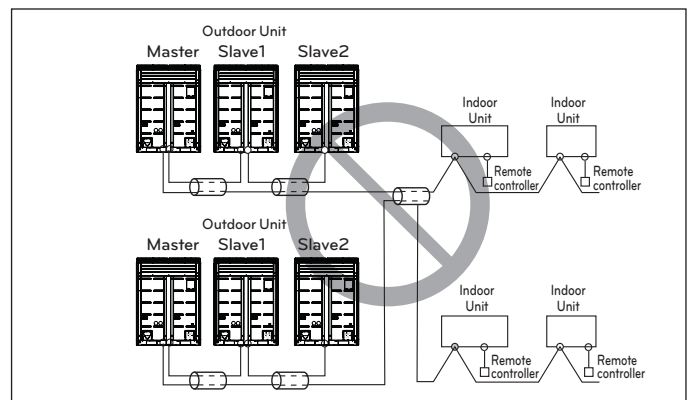

Multi-Core Cable

**CAUTION**

- Use the 2-core shield cables for communication cables. Never use them together with power cables.
- The conductive shielding layer of cable should be grounded to the metal part of both units.
- Never use multi-core cable
- As this unit is equipped with an inverter, to install a phase leading capacitor not only will deteriorate power factor improvement effect, but also may cause capacitor abnormal heating. Therefore, never install a phase leading capacitor.
- Make sure that the power unbalance ratio is not greater than 2%. If it is greater the units lifespan will be reduced.

**Precautions when laying power wiring**

Use round pressure terminals for connections to the power terminal block.

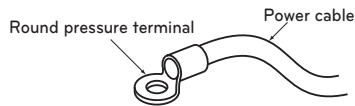

- When none are available, follow the instructions below.
- Do not connect wiring of different thicknesses to the power terminal block. (Slack in the power wiring may cause abnormal heat.)
  - When connecting cable which is the same thickness, do as shown in the figure below.

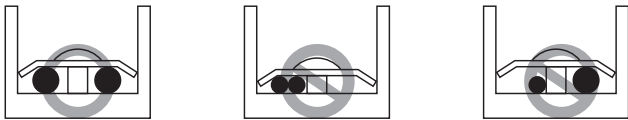

- For wiring, use the designated power cable and connect firmly, then secure to prevent outside pressure being exerted on the terminal block.
- Use an appropriate screwdriver for tightening the terminal screws. A screwdriver with a small head will strip the head and make proper tightening impossible.
- Over-tightening the terminal screws may break them.

**CAUTION**

When the 400 volt power supply is applied to "N" phase by mistake, check damaged parts in control box and replace them.

**Control box and connecting position of wiring**

- Remove all of the screws at front panel and remove the panel by pulling it forward.
- Connect communication cable between main and sub outdoor unit through the terminal block.
- Connect communication cables between outdoor unit and indoor units through the terminal block.
- When the central control system is connected to the outdoor unit, a dedicated PCB must be connected between them.
- When connecting communication cable between outdoor unit and indoor units with shielded cable, connect the shield ground to the earth screw.

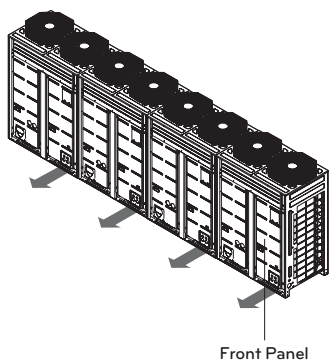

**WARNING**

The temperature sensor for outdoor air should not be exposed to direct sunlight.  
- Provide an appropriate cover to intercept direct sunlight.

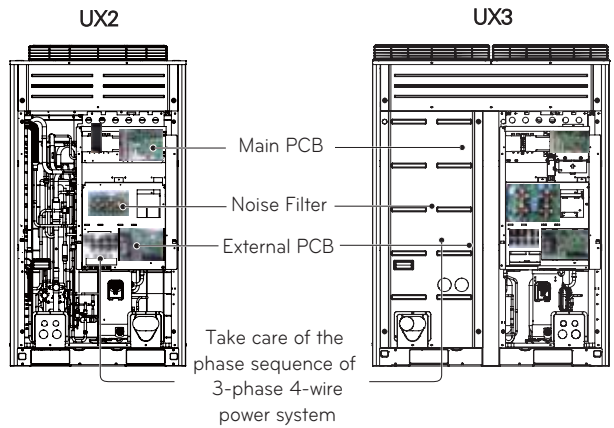

**Communication and Power Cables**

**Communication cable**

- Types : shielding cable
- Cross section : 1.0~1.5mm<sup>2</sup>
- Maximum allowable temperature: 60°C
- Maximum allowable cable length: under 1000m

**Remote control cable**

- Types : 3-core cable

**Central control cable**

Product type	Cable type	Diameter
ACP&AC Manager	2-core cable (Shielding cable)	1.0~1.5mm <sup>2</sup>
AC Smart	2-core cable (Shielding cable)	1.0~1.5mm <sup>2</sup>
Simple central controller	4-core cable (Shielding cable)	1.0~1.5mm <sup>2</sup>

**Separation of communication and power cables**

- If communication and power cables are run alongside each other then there is a strong likelihood of operational faults developing due to interference in the signal wiring caused by electrostatic and electromagnetic coupling. The tables below indicates our recommendation as to appropriate spacing of communication and power cables where these are to be run side by side

100V or more	Current capacity of power cable	Spacing
	10A	300mm
50A	500mm	
100A	1000mm	
Exceed 100A	1500mm	

**NOTE**

- The figures are based on assumed length of parallel cabling up to 100m. For length in excess of 100m the figures will have to be recalculated in direct proportion to the additional length of cable involved.
- If the power supply waveform continues to exhibit some distortion the recommended spacing in the table should be increased.
  - If the cable are laid inside conduits then the following point must also be taken into account when grouping various cable together for introduction into the conduits
  - Power cable(including power supply to air conditioner) and communication cables must not be laid inside the same
  - In the same way, when grouping the power wires and communication cables should not be bunched together.

**CAUTION**

If apparatus is not properly earthed then there is always a risk of electric shocks, the earthing of the apparatus must be carried out by a qualified person.

**Wiring of main power supply and equipment capacity**

- Use a separate power supply for the Outdoor Unit and Indoor Unit.
- Bear in mind ambient conditions (ambient temperature, direct sunlight, rain water, etc.) when proceeding with the wiring and connections.
- The cable size is the minimum value for metal conduit wiring. The power cord size should be 1 rank thicker taking into account the line voltage drops. Make sure the power-supply voltage does not drop more than 10%.
- Specific wiring requirements should adhere to the wiring regulations of the region.
- Power supply cords of parts of appliances for outdoor use should not be lighter than polychloroprene sheathed flexible cord.
- Don't install an individual switch or electrical outlet to disconnect each of indoor unit separately from the power supply.

**WARNING**

- Follow ordinance of your governmental organization for technical standard related to electrical equipment, wiring regulations and guidance of each electric power company.
- Make sure to use specified cables for connections so that no external force is imparted to terminal connections. If connections are not fixed firmly, it may cause heating or fire.
- Make sure to use the appropriate type of overcurrent protection switch. Note that generated overcurrent may include some amount of direct current.

**CAUTION**

- Some installation site may require attachment of an earth leakage breaker. If no earth leakage breaker is installed, it may cause an electric shock.
- Do not use anything other than breaker and fuse with correct capacity. Using fuse and wire or copper wire with too large capacity may cause a malfunction of unit or fire.

**Point for attention regarding quality of the public electric power supply**

This equipment complies with respectively:

- EN/IEC 61000-3-11 (1) provided that the system impedance  $Z_{sys}$  is less than or equal to  $Z_{max}$  and
- EN/IEC 61000-3-12 (2) provided that the short-circuit power  $S_{sc}$  is greater than or equal to the minimum  $S_{sc}$  value at the interface point between the user's supply and the public system. It is the responsibility of the installer or user of the equipment to ensure, by consultation with the distribution network operator if necessary, that the equipment is connected only to a supply with respectively:
  - $Z_{sys}$  less than or equal to  $Z_{max}$  and
  - $S_{sc}$  greater than or equal to the minimum  $S_{sc}$  value.

Standard combination of outdoor units	$Z_{max}$ ( $\Omega$ )	Minimum $S_{sc}$ Value (kVA)
ARUB080LTE4	-	3921
ARUB100LTE4	-	6415
ARUB120LTE4	-	6415
ARUB140LTE4	-	4964
ARUB160LTE4	-	4964
ARUB180LTE4	-	6994
ARUB200LTE4	-	6994

- (1) European / International Technical Standard setting the limits for voltage changes, voltage fluctuations and flicker in public low-voltage supply systems for equipment with rated current  $\leq 75$  A.
- (2) European / International Technical Standard setting the limits for harmonic currents produced by equipment connected to public low-voltage systems with input current  $>16$  A and  $\leq 75$  A per phase.

# Field Wiring

## Single outdoor unit

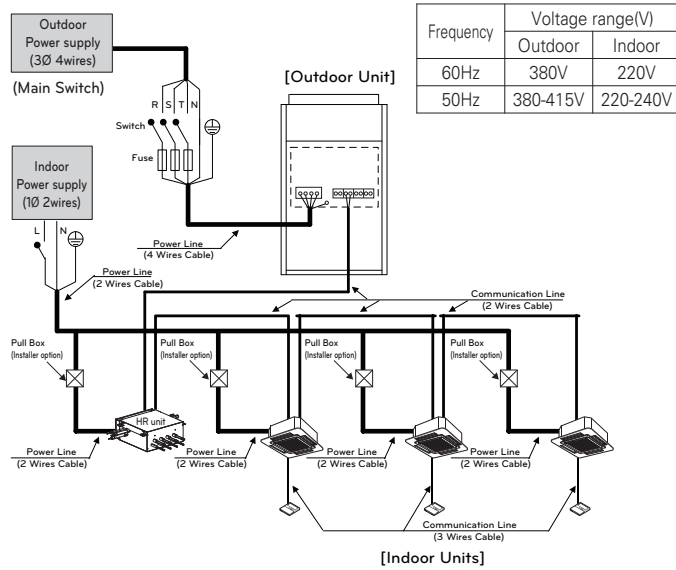

### ! WARNING

When the total capacity is over than as follow, the power source do not use in series between the units.  
The First terminal block could be burnt out. (Heat Pump : 62 Hp)

When the power source is supplied to Each outdoor unit individually.

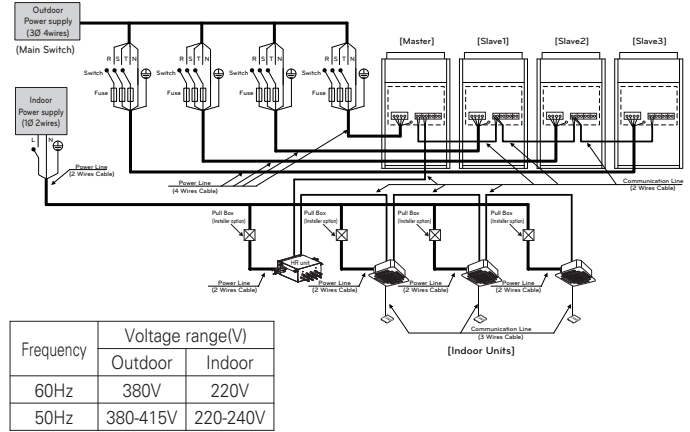

### ! WARNING

- Indoor Unit ground wires are required for preventing electrical shock accident during current leakage, Communication disorder by noise effect and motor current leakage (without connection to pipe).
- Don't install an individual switch or electrical outlet to disconnect each of indoor unit separately from the power supply.
- Install the main switch that can interrupt all the power sources in an integrated manner because this system consists of the equipment utilizing the multiple power sources.
- If there exists the possibility of reversed phase, lose phase, momentary blackout or the power goes on and off while the product is operating, attach a reversed phase protection circuit locally. Running the product in reversed phase may break the compressor and other parts.

### ! WARNING

- Indoor Unit ground wires are required for preventing electrical shock accident during current leakage, Communication disorder by noise effect and motor current leakage (without connection to pipe).
- Don't install an individual switch or electrical outlet to disconnect each of indoor unit separately from the power supply.
- Install the main switch that can interrupt all the power sources in an integrated manner because this system consists of the equipment utilizing the multiple power sources.
- If there exists the possibility of reversed phase, lose phase, momentary blackout or the power goes on and off while the product is operating, attach a reversed phase protection circuit locally. Running the product in reversed phase may break the compressor and other parts.

## Between Indoor and Master Outdoor unit

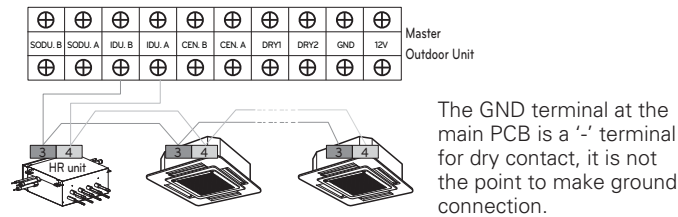

## Between Indoor and Master Outdoor unit

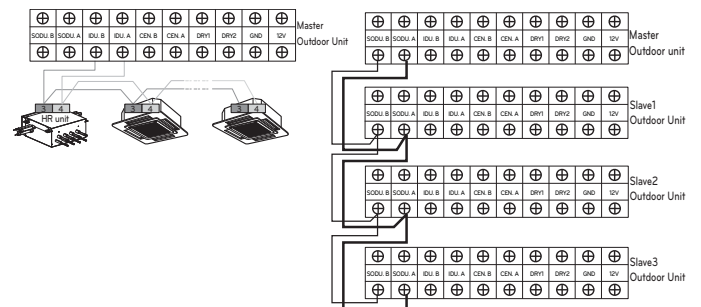

## Series outdoor units

When the power source is connected In series between the units.

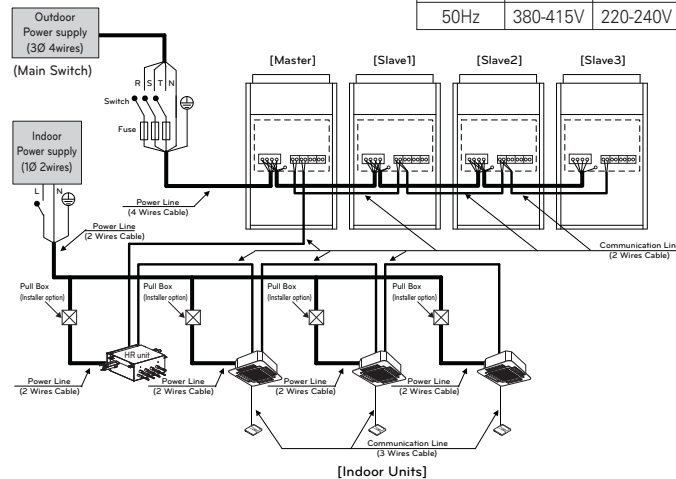

The GND terminal at the main PCB is a '-' terminal for dry contact. It is not the point to make ground connection.

- Make sure that terminal number of master and slave outdoor units are matched.(A-A,B-B)

**Example) Connection of transmission wire**

[BUS type]

- Connection of communication cable must be installed like below figure between indoor unit to outdoor unit.

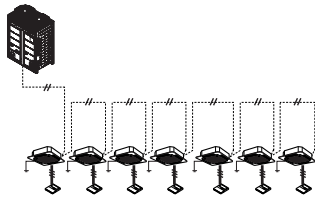

[STAR type]

- Abnormal operation can be caused by communication defect, when connection of communication cable is installed like below figure(STAR type).

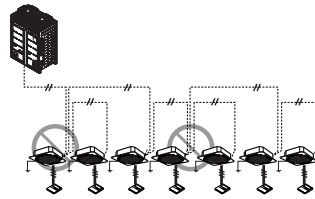

Front Side 1

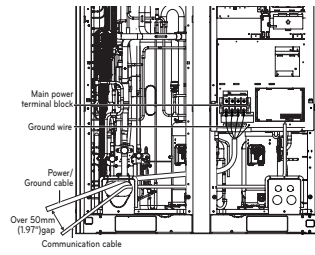

Front Side 2

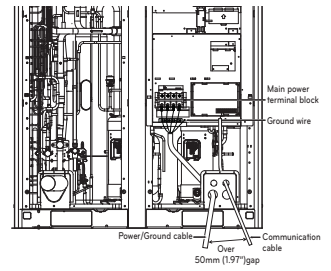

Main Power Connection

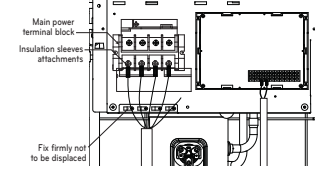

Communication Connection

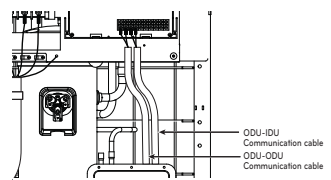

**Example) Connection of power and communication cable (UX2)**

Left Side

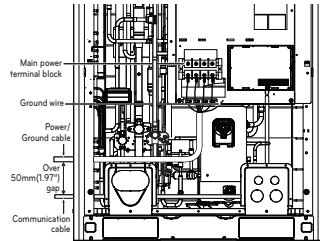

Right Side

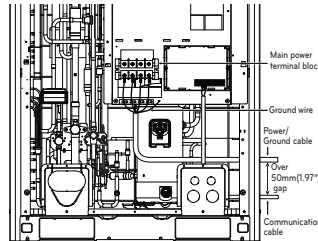

Front Side 1

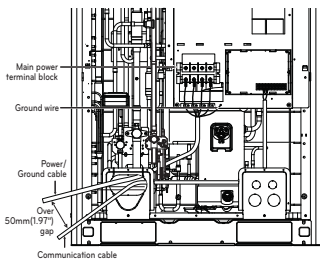

Front Side 2

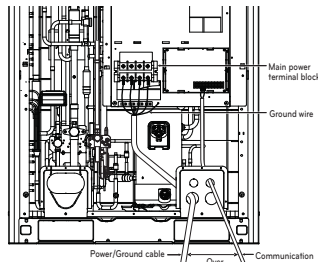

Main Power Connection

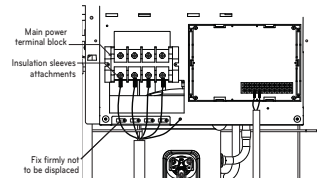

Communication Connection

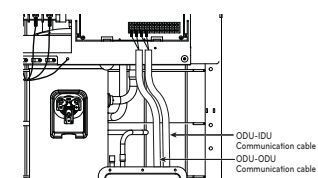

**CAUTION**

It should be wiring power cables or communication cables to avoid interference with the oil level sensor. Otherwise, That oil level sensor would be operated abnormally.

**Checking the setting of outdoor units**

**Checking according to dip switch setting**

- You can check the setting values of the Master outdoor unit from the 7 segment LED. The dip switch setting should be changed when the power is OFF.

**Checking the initial display**

The number is sequentially appeared at the 7 segment in 5 seconds after applying the power. This number represents the setting condition.

• Initial display order

Order	No	Mean
①	8~20	Master model capacity
②	10~20	Slave 1 model capacity
③	10~20	Slave 2 model capacity
④	10~20	Slave 3 model capacity
⑤	8~80	Total capacity
⑥	1	Cooling Only
	2	Heat Pump
	3	Heat Recovery
⑦	38	380V model
	46	460V model
⑧	22	220V model
	1	Full function
	2	Core function

**CAUTION**

It should be wiring power cables or communication cables to avoid interference with the oil level sensor. Otherwise, That oil level sensor would be operated abnormally.

• Example) ARUB620LTE4

①	②	③	④	⑤	⑥	⑦	⑧
18	16	14	14	62	3	38	1

• Master Unit

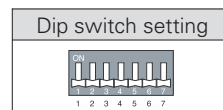

• Slave Unit

Dip switch setting	ODU Setting
	Slave 1
	Slave 2
	Slave 3

**Example) Connection of power and communication cable (UX3)**

Left Side

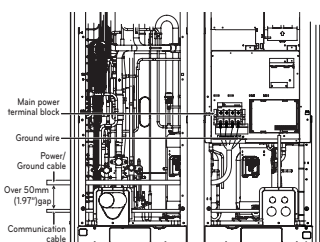

Right Side

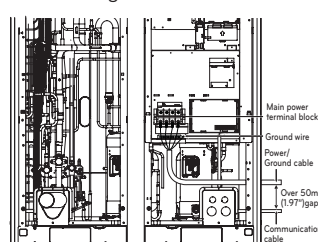

# HR Unit PCB

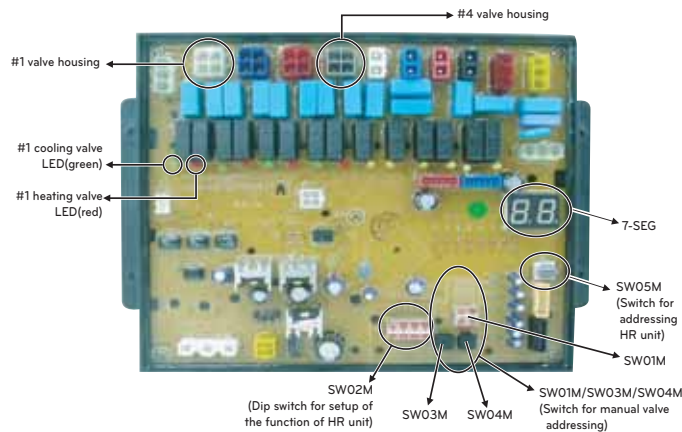

## Switch for setup of HR Unit

### Main function of SW02M

<p>SW02M</p>	ON S/W	Selection	
	No.1	Method for addressing valves of an HR unit (Auto/Manual)	
	No.2	Model of HR unit	
	No.3	Model of HR unit	
	No.4	Model of HR unit	
	No.5	Valve group setting	
	No.6	Valve group setting	
	No.7	Use only in factory production (preset to "OFF")	Zoning setting ("ON")
No.8	Use only in factory production (preset to "OFF")		

### 1 Selection of the method for addressing valves of an HR unit (Auto/Manual)

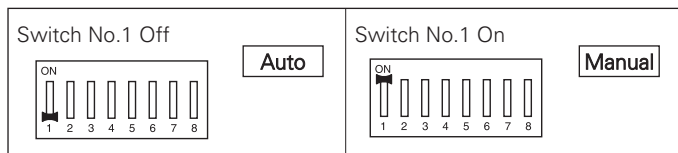

### 2 Setting the zoning control

	DIP S/W setting	
Normal control		<p>SW01M</p>
Zoning control		<p>SW01M</p> <p>Turn the dip switch of the zoning branch on. Ex) Branch 1,2 are zoning control.</p>

### 3 Selection of the model of the HR unit

	(For 2 branches) PRHR021	(For 3 branches) PRHR031	(For 4 branches) PRHR041
Initial Setting			
1 branches Connected			
2 branches Connected			
3 branches Connected			
4 branches Connected			

\* Each model is shipped with the switches No.2 and No.3 pre-adjusted as above in the factory.

### ! WARNING

- If you want to use a PRHR031 for 2 branches HR unit after closing the 3rd pipes, set the dip switch for 2 branches HR unit.
- If you want to use a PRHR041 for 3 branches HR unit after closing the 4th pipes, set the dip switch for 3 branches HR unit.
- If you want to use a PRHR041 for 2 branches HR unit after closing the 3rd and 4th pipes, set the dip switch for 2 branches HR unit.
- The unused port must be closed with a copper cap, not with a plastic cap.

### 4 Setting the Valve Group.

	DIP S/W setting	Example
Not control		
No.1, 2 Valve Control		
No.2, 3 Valve Control		
No.3, 4 Valve Control		
No.1, 2 Valve / No.3, 4 Valve Control		

### ! NOTE

If the large capacity indoor units are installed, below Y branch pipe should be used.

Y branch pipe

[Unit:mm]

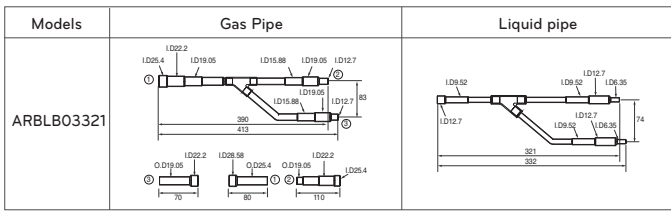

**SW05M (Rotary S/W for addressing HR unit)**

Must be set to '0' when installing only one HR unit.  
When installing multiple HR units, address the HR units with sequentially increasing numbers starting from '0'.

Ex) Installation of 3 HR units

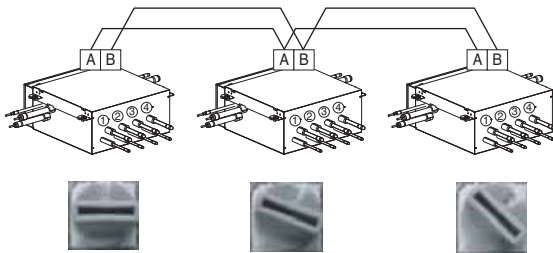

**SW01M/SW03M/SW04M (Dip S/W and tact S/W for manual valve addressing)**

1 Normal setting (Non-Zoning setting)

- Set the address of the valve of the HR unit to the central control address of the connected indoor unit.
- SW01M: selection of the valve to address
- SW03M: increase in the digit of 10 of valve address
- SW04M: increase in the last digit of valve address
- Prerequisite for manual valve addressing : central control address of each indoor unit must be preset differently at its wired remote control.

S/W No.	Setup
No.1	Manual addressing of valve #1
No.2	Manual addressing of valve #2
No.3	Manual addressing of valve #3
No.4	Manual addressing of valve #4
SW03M	Increase in the digit of 10 of valve address
SW04M	Increase in the last digit of valve address

2 Zoning setting

- Set the address of the valve of the HR unit to the central control address of the connected indoor unit.
- SW01M : selection of the valve to address
- SW03M : increase in the digit of 10 of valve address
- SW04M : increase in the last digit of valve address
- SW05M : Rotary S/W
- Prerequisite for manual valve addressing : central control address of each indoor unit must be preset differently at its wired remote control.

S/W No.	Setup
No.1	Manual addressing of valve #1
No.2	Manual addressing of valve #2
No.3	Manual addressing of valve #3
No.4	Manual addressing of valve #4
SW03M	Increase in the digit of 10 of valve address
SW04M	Increase in the last digit of valve address
SW05M	Manual addressing of zoning indoor units

**Automatic Addressing**

**The address of indoor units would be set by Automatic Addressing**

- Wait for 3 minutes after supplying power. (Master and Slave outdoor units, indoor units)
- Press RED button of the outdoor units for 5 seconds. (SW01C)
- A "88" is indicated on 7-segment LED of the outdoor unit PCB.
- For completing addressing, 2~7 minutes are required depending on numbers of connected indoor units
- Numbers of connected indoor units whose addressing is completed are indicated for 30 seconds on 7-segment LED of the outdoor unit PCB
- After completing addressing, address of each indoor unit is indicated on the wired remote control display window. (CH01, CH02, CH03, ....., CH06 : Indicated as numbers of connected indoor units)

[MAIN PCB]

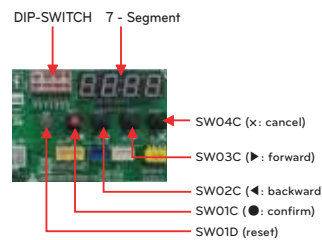

**CAUTION**

- In replacement of the indoor unit PCB, always perform Automatic addressing setting again (At that time, please check about using Independent power module to any indoor unit.)
- If power supply is not applied to the indoor unit, operation error occur.
- Automatic Addressing is only possible on the master Unit.
- Automatic Addressing has to be performed after 3 minutes to improve communication.

**Automatic pipe detection**

- 1 Turn No.1 of SW02M of HR unit PCB off.
  - 2 Confirm that the setting of No.2, 3 of SW02M corresponds with the number of indoor units.
  - 3 Reset the power of HR unit PCB
  - 4 Master unit PCB DIP switch on : No.5
  - 5 Select the mode using '▶', '◀' Button : "Idu" Push the '●' button
  - 6 Select the "Id 5" function using '▶', '◀' Button : "Ath" or "Atc" Push the '●' button.  
Outdoor temperature is over 15°C(59°F) : "Atc" Using (If it fail, use "Ath")  
Outdoor temperature is below 15°C(59°F) : "Ath" Using (If it fail, use "Atc")
  - 7 Select the mode using '▶', '◀' Button : "Idu" Push the '●' button
  - 8 Select the "Id 6" function using '▶', '◀' Button : "StA" Push the '●' button
  - 9 Operated after 88 is displayed on 7-SEG of the outdoor unit main PCB.
  - 10 Pipe detection proceed.
  - 11 5~30 minutes are required depending on the number of the indoor units and outdoor temperature.
  - 12 The number of the indoor units installed is displayed on 7-SEG of the outdoor unit main PCB for about 1 minute
    - For a HR unit, the number of the indoor units connected to each HR unit is displayed.
    - '200' is displayed in case of auto pipe detection error, and auto detection is completed after '88' is disappeared.
- \* Auto pipe detection function : the function that sets connection relationship automatically between the indoor unit and HR unit.

**! WARNING**

- Execute auto addressing and auto pipe detection again whenever the indoor PCB and HR unit PCB is replaced.  
- Operation error occurs unless power is applied to the indoor and HR units.
- Error No.200 occurs if the number of connected indoor units and that of scanned indoor units are different.
- When auto pipe detection fails, complete it with manual pipe detection (see Manual pipe detection).
- When auto pipe detection addressing is completed normally, manual pipe detection is not required.
- If you want to do auto pipe detection again after auto pipe detection fails, do after reset of outdoor unit by all means.
- During 5 minutes after pipe detection is completed, do not turn off the main unit PCB to save the result of pipe detection automatically.

**Manual pipe detection**

- 1 Enter the central control address into each indoor unit using its wired remote control.
- 2 Turn No.1 of SW02M of HR unit PCB on.
- 3 Reset the power of HR unit PCB.
- 4 On the HR unit PCB, manually set address of each valve of the HR unit to the central control address of the indoor unit connected to the valve.
- 5 Reset the power of outdoor unit PCB.
- 6 The number of the indoor unit installed is displayed after about 5 minutes.  
Ex) HR → The number of the indoor
- 7 Reset the power of outdoor unit PCB, HR unit.
- 8 Manual pipe detection is completed

**! WARNING**

- In case that central controller is not installed, remain the address data after installer sets central control address as he wants
- In case that central controller is installed, there would be central control address in wired remote control of indoor unit.
- In this case, set the HR unit manual pipe address according to central control address of indoor unit.
- Pipe which is not connected with indoor unit should be set different address with pipe Connected with indoor unit.  
(If addresses are piled up, corresponding valve is not working.)
- If you want to change the setting of manual pipe, you should do it on HR unit PCB.
- If an error occurred, it means that manual pipe setting is not completed.
- During 5 minutes after pipe detection is completed, do not turn off the main unit PCB to save the result of pipe detection automatically.

**The Procedure of Automatic Addressing**

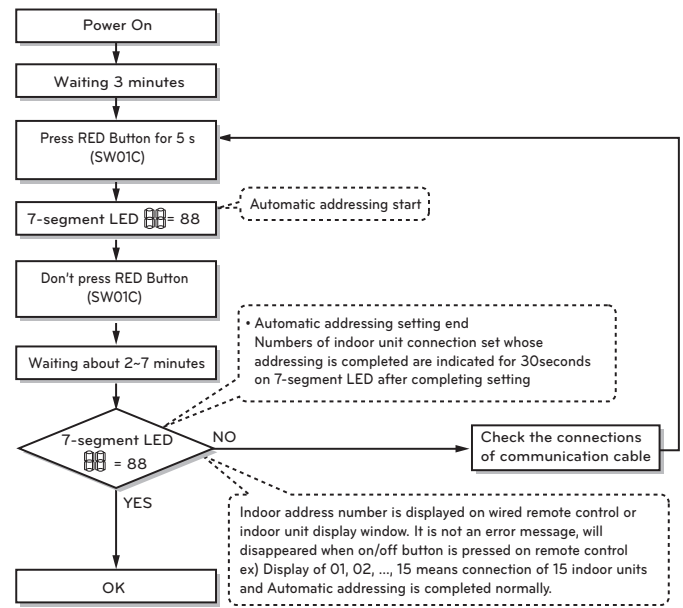

**Flow chart of auto addressing for pipe detection**

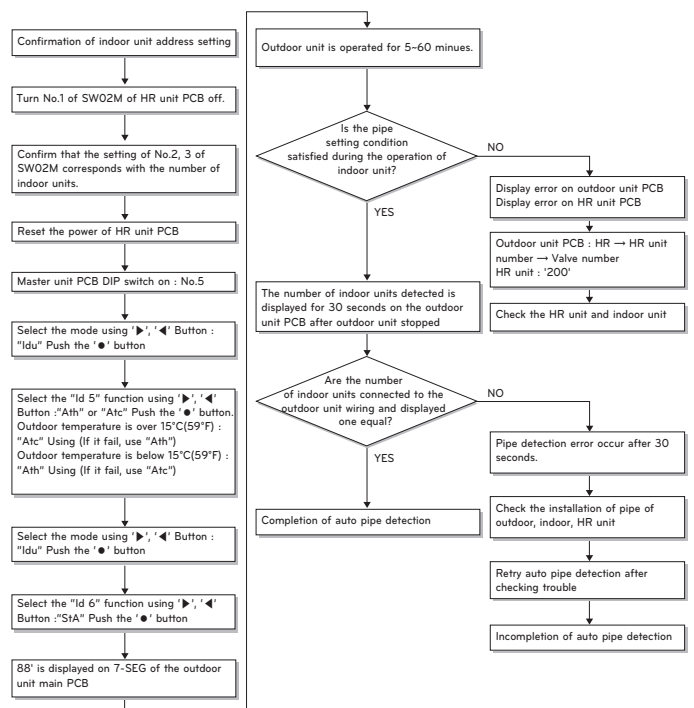

\* It is possible to be generated mode changing noise of heating and cooling which is normal.  
There is no mode changing noise at normal operation.

DIP-SW01 7 - Segment

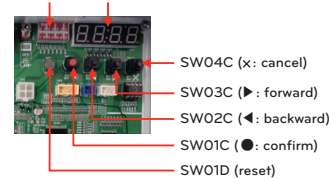

## Flow chart of manual addressing for pipe detection

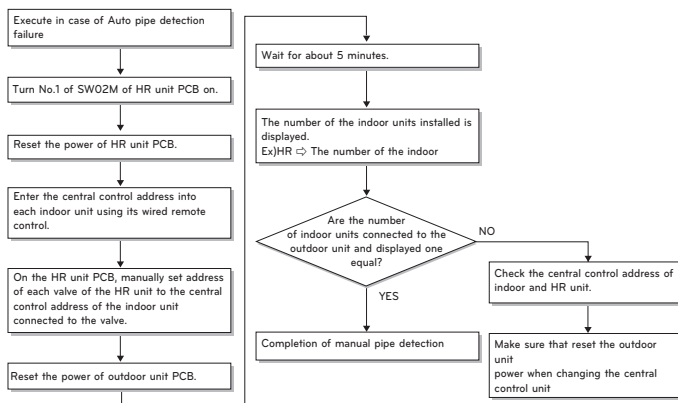

## Example of manual valve addressing (Non-Zoning setting)

(In case that an indoor unit of central control address "11" is connected to a valve #1 of an HR unit)

- Prerequisite for manual valve addressing: central control address of each indoor unit must be preset differently at its wired remote control.

No.	Display and setup	Setup and Contents
1		- Operation: None - Display: None
2		- Operation: Turn dip S/W No.1 on to address valve #1 - Display: Existing value saved in EEPROM is displayed in 7-SEG.
3		- Operation: Set the digit of 10 to the number in Group High data of the wired remote control connected to the corresponding indoor unit to the valve #1 by pressing left tack S/W. - Display: Digit increasing with the times of pressing tack S/W is displayed in left 7-SEG
4		- Operation: Set the digit of 1 to the number in Group Low data of the wired remote control connected to the corresponding indoor unit to the valve #1 by pressing right tack S/W. - Display: Digit increasing with the times of pressing tack S/W is displayed in right 7-SEG
5		- Operation: Turn dip S/W No.1 off to save the address of valve #1 - Display: "11" displayed in 7-SEG disappears

- Above setup must be done for all HR unit valves.
- The valve that is not connected with any indoor unit should be addressed with any other number than used address numbers of the valves connected with indoor units.  
(The valves does not work if the address numbers are same.)

## Example of manual valve addressing (Zoning setting)

(In case that an indoor unit of central control address "11" is connected to a valve #1 of an HR unit)

Zoning control is connecting 2 or more indoor units at one pipe of HR unit. In case of Zoning control, in order to set controls with multiple indoor units connection uses the rotary switch. Namely, only the rotary switch changes from same valve set condition and set indoor units connection.

- 1 On dip switch of the corresponding valves and sets the rotary switch at 0.
- 2 Setting the number with tact switch.
- 3 In case of addition of indoor units to same port, increases 1 with the rotary switch and sets number with tact switch.
- 4 In case of checking the number which the corresponding valve is stored, turn on dip switch and set the number of rotary switch.
- 5 Indoor units set available 7 per a port(rotary switch 0~6), in case of setting above of 7 with rotary switch, it will display error.
- 6 Setting the rotary switch on original condition(HR unit number set conditions) after all finishing a piping setting.
- 7 The rotary switch set value of above number of indoor units which is connected with FF and prevents a malfunction.  
(Example: The case where 3 indoor units is connected in piping 1, sets from rotary switch 0,1,2 and 3,4,5 with FF set)  
- Prerequisite for manual valve addressing: central control address of each indoor unit must be preset differently at its wired remote control.

No.	Display and setup	Setup and Contents
1		- Operation: None - Display: None
2		- Operation : Turn dip S/W No.1 on to address valve #1 - Display : Existing value saved in EEPROM is displayed in 7-SEG.
3		- Operation : Set the digit of 10(1) to the number in Group High data of the wired remote control connected to the corresponding indoor unit to the valve #1 by pressing left tack S/W. - Display : Digit increasing with the times of pressing tack S/W is displayed in left 7-SEG.
4		- Operation : SW05M : 1 - Display : Display former value.
5		- Operation : Setting No. using SW03M and SW04M, SW05M : 1 - Display : Display setting value.
6		- Operation : Turn dip S/W No.1 off to save the address of valve #1 - Display : "11" displayed in 7-SEG disappears.
7		- Operation : Return valve of addressing HR unit. - Display : None

- Above setup must be done for all HR unit valves.
- The valve that is not connected with any indoor unit should be addressed with any other number than used address numbers of the valves connected with indoor units.  
(The valves does not work if the address numbers are same.)

### Example of checking valve address

(In case that an indoor unit of central control address "11" is connected to a valve #1 of an HR unit)

No.	Display and setup	Setup and Contents
1		- Operation: Turn dip S/W No.1 on. - Display: "11" is displayed in 7-SEG
2		- Operation: Turn dip S/W No.1 on. - 7-SEG disappeared

### Identification of Manual Valve ID (Address)

No.	Display and setup	Setup and Contents
1		- Operation: more than 2 dip switches turned on. - Display: "Er" is displayed in 7-SEG

### Method of checking the pipe detection result at outdoor unit

- 1 Wait for 5 minutes, after Pipe detection is completed.
- 2 Turn on the No.10,14,16 DIP S/W of SUB PCB at master unit
- 3 Check the data on 7- segment, switching rotary 01,02.

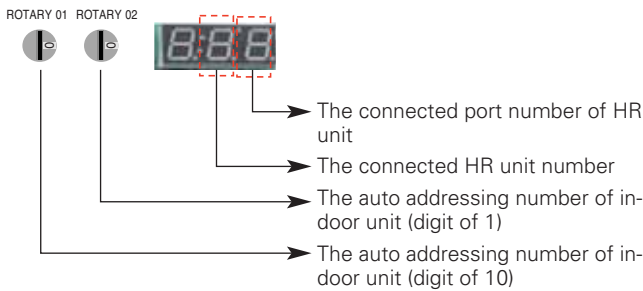

### Setting method of Master indoor unit in zoning

- 1 Turn dip switch 5,6,10 on at system off.
- 2 Set the left Rotary switch for HR unit.(Rotary switch No. "0" ' HR unit No. "1")
- 3 Set the right Rotary switch for IDU unit.(Rotary switch No. "0" ' HR unit branch No. "1")
- 4 Display the Master IDU No. of the HR unit on 7segment.(Default display is "00" on 7segment)
- 5 Press the black button.(The IDU No. increase every 1 second in the zoning )
- 6 Set the Master IDU(Press the red button during 1.5seconds stop twinkling)

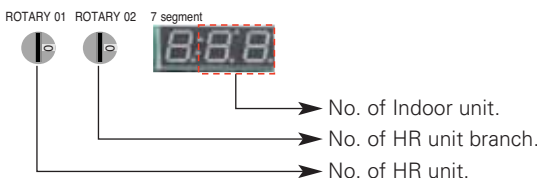

#### CAUTION

- Waiting for 80seconds after power on.
- The zoning information and Master IDU information remove from EEPROM after Auto-addressing.
- If there is installed the central control, it is impossible setting of Master IDU in zoning.

### Setting the function

Select the mode/function/option/value using '▶', '◀' Button and confirm that using the '●' button after dip switch No.5 is turned on.

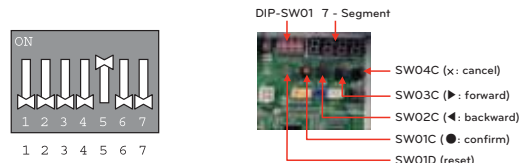

Mode	Function	Option	Value	Action	Remarks						
Content	Display1	Content	Display2	Content	Display3	Content	Display4	Implement	Display5		
Installation	Func	Static pressure compensation	F <sub>n2</sub>	oFF	op1~op3	Selected the option	-	-	Change the set value	Blank	Save in EEPROM
		Night low noise	F <sub>n3</sub>	oFF	op1~op12	Selected the option	-	-	Change the set value	Blank	Save in EEPROM
		Overall defrost	F <sub>n4</sub>	on	oFF	Selected the option	-	-	Change the set value	Blank	Save in EEPROM
		ODU address	F <sub>n5</sub>	-	-	-	0-255	set the value	Change the set value	Blank	Save in EEPROM
		Snow removal & rapid defrost	F <sub>nb</sub>	oFF	op1~op3	Selected the option	-	-	Change the set value	Blank	Save in EEPROM
		IDU capacity adjusting	F <sub>n7</sub>	on	oFF	Selected the option	-	-	Change the set value	Blank	Save in EEPROM
		Target pressure adjusting	F <sub>n8</sub>	op1~op4	Selected the option	-	-	-	Change the set value	Blank	Save in EEPROM
		Comfort Operation	F <sub>n9</sub>	on	oFF	Selected the option	-	-	Change the set value	Blank	Save in EEPROM

\* Functions save in EEPROM will be kept continuously, though the system power was reset.

### Group Number setting

#### Group Number setting for Indoor Units

- Confirm the power of whole system(Indoor Unit, Outdoor Unit) is OFF, otherwise turn off.
- The communication cables connected to CEN.A and CEN.B terminal should be connected to central control of Outdoor Unit with care for their polarity (A-A, B-B ).
- Turn the whole system on.
- Set the group and Indoor Unit number with a wired remote control.
- To control several sets of Indoor Units into a group, set the group ID from 0 to F for this purpose.

#### Outdoor Units (External PCB)

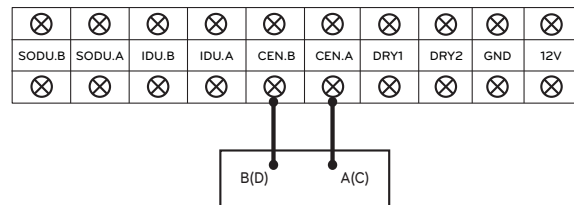

Example) Group number setting

1 E  
Group Indoor unit

- 1<sup>st</sup> number indicate the group number
- 2<sup>nd</sup> number point out indoor unit number

Group recognizing the central controller	
No.0 group (00~0F)	
No.1 group (10~1F)	
No.2 group (20~2F)	
No.3 group (30~3F)	
No.4 group (40~4F)	
No.5 group (50~5F)	
No.6 group (60~6F)	
No.7 group (70~7F)	
No.8 group (80~8F)	
No.9 group (90~9F)	
No. A group (A0~AF)	
No. B group (B0~BF)	
No. C group (C0~CF)	
No. D group (D0~DF)	
No. E group (E0~EF)	
No. F group (F0~FF)	

### WARNING

- Valve address and central control address of its corresponding indoor unit should be set identical in manual addressing.

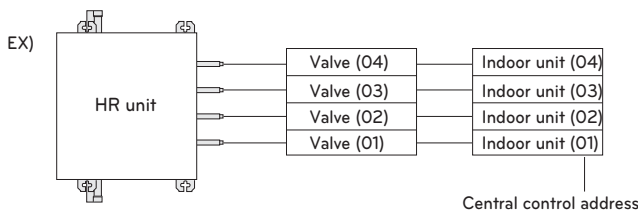

## Static pressure compensation mode

This function secures the air flow rate of ODU, in case static pressure has been applied like using duct at fan discharge of ODU.

### Static pressure compensation mode setting method

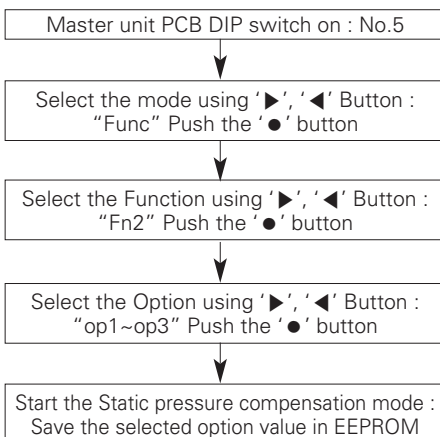

### FAN Maximum RPM of each step

Capacity		8~12 HP	14~20 HP
Max. RPM	Standard	730	950
	op1	760	1020
	op2	780	1050
	op3	800	1130

## Night Low Noise Function

In cooling mode, this function makes the ODU fan operate at low RPM to reduce the fan noise of ODU at night which has low cooling load.

### Night low noise function setting method

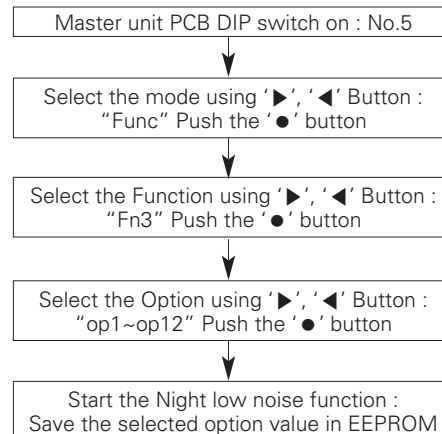

### Time Settings

Step	Judgment Time(Hr)	Operation Time(Hr)
op1	8	9
op2	6.5	10.5
op3	5	12
op4	8	9
op5	6.5	10.5
op6	5	12
op7	8	9
op8	6.5	10
op9	5	12
op10	Continuous operation	
op11	Continuous operation	
op12	Continuous operation	

### Noise

Heat Pump	Capacity	
	8~12HP	14~20HP
Step	Noise(dB)	
op1~op3, op10	55	59
op4~op6, op11	52	56
op7~op9, op12	49	53

### CAUTION

- Request installer to set the function during installation.
- If ODU RPM changes, cooling capacity may go down.

## Overall defrost mode

### Mode setting method

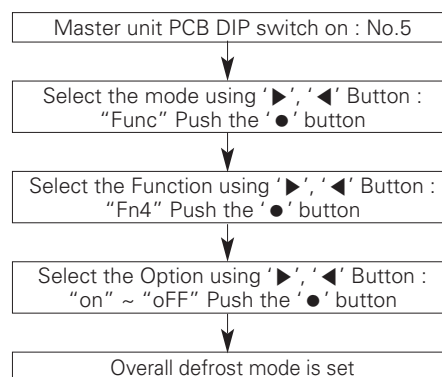

### Mode setting

- on: Operate overall defrost
- off: Operate partial defrost

### CAUTION

- Ask an authorized technician to setting a function.

## Setting the ODU address

### Mode setting method

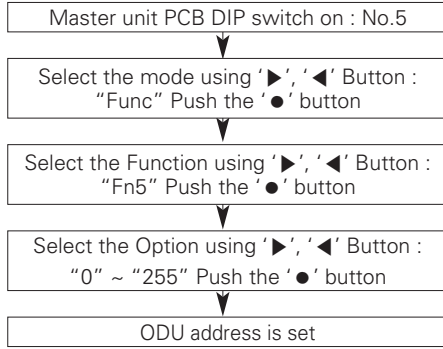

### CAUTION

- Ask an authorized technician to setting a function.
- If use a function, first install a Central controller.

## Snow removal & rapid defrost

### Mode setting method

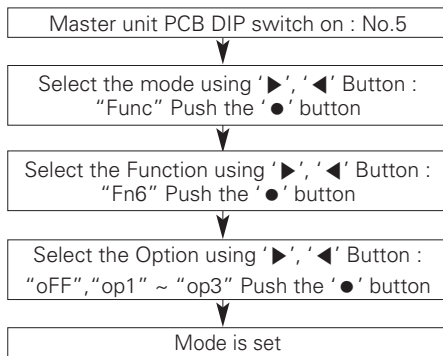

### Mode setting

setting	Mode
oFF	Not setting
op1	Snow removal mode
op2	Rapid defrost mode
op3	Snow removal mode. + Rapid defrost mode.

### CAUTION

- Ask an authorized technician to setting a function.
- If do not use a function, set an off-mode.

## IDU capacity adjusting

If the operation of indoor unit is more than 130%, the air flow is operated as low in the all indoor units.

### Mode setting method

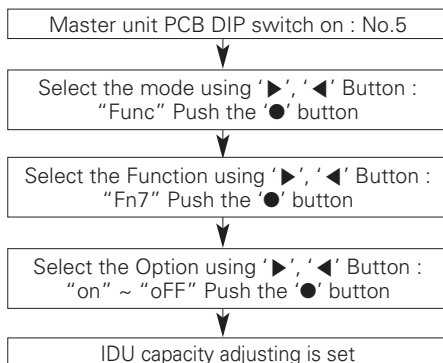

Step	Mode
OFF	Not setting
ON	Low capacity mode

### CAUTION

- Ask an authorized technician to setting a function.

## Target pressure adjusting

### Mode setting method

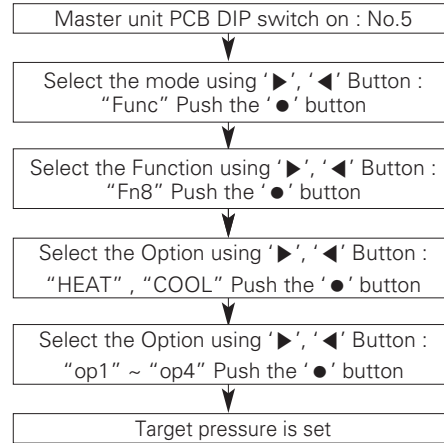

### Setting

Mode	Purpose		Condensing temperature variation	Evaporating temperature variation
	Heat	Cool		
op1	Increase capacity	Increase capacity	+2 °C	-3 °C
op2	Decrease power consumption	Increase capacity	-2 °C	-1.5 °C
op3	Decrease power consumption	Decrease power consumption	-4 °C	+2.5 °C
op4	Decrease power consumption	Decrease power consumption	-6 °C	-4.5 °C

### CAUTION

- Ask an authorized technician to setting a function.
- If do not use a function, set an off-mode.
- Change a power consumption or capacity.

## Comfort Operation

### Mode setting method

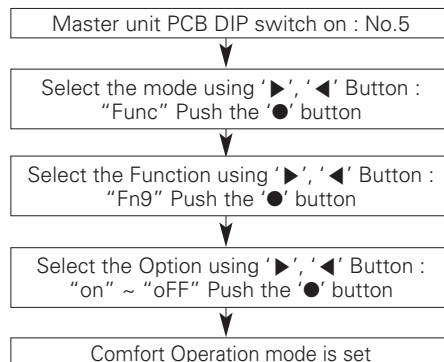

Step	Mode
OFF	Not setting
ON	Changing the low pressure target in cooling

### CAUTION

- Ask an authorized technician to setting a function.
- \* If do not use a function, set an off-mode.

## Self-Diagnosis Function

### Error Indicator

- This function indicates types of failure in self-diagnosis and occurrence of failure for air condition.
- Error mark is displayed on display window of indoor units and wired remote controller, and 7-segment LED of outdoor unit control board as shown in the table.
- If more than two troubles occur simultaneously, lower number of error code is first displayed.
- After error occurrence, if error is released, error LED is also released simultaneously.

### Error Display

1st,2nd,3rd LED of 7-segment indicates error number, 4th LED indicates unit number. (\* = 1: Master, 2: Slave 1, 3: Slave 2, 4: Slave 3)

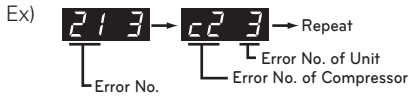

\* Refer to the DX-Ventilation manual for DX-Ventilation error code.

Display			Title	Cause of Error	
Indoor unit related error	0	1	-	Air temperature sensor of indoor unit	Air temperature sensor of indoor unit is open or short
	0	2	-	Inlet pipe temperature sensor of indoor unit	Inlet pipe temperature sensor of indoor unit is open or short
	0	3	-	Communication error : wired remote controller ↔ indoor unit	Failing to receive wired remote controller signal in indoor unit PCB
	0	4	-	Drain pump	Malfunction of drain pump
	0	5	-	Communication error : outdoor unit ↔ indoor unit	Failing to receive outdoor unit signal in indoor unit PCB
	0	6	-	Outlet pipe temperature sensor of indoor unit	Outlet pipe temperature sensor of indoor unit is open or short
	0	9	-	Indoor EEPROM Error	In case when the serial number marked on EEPROM of Indoor unit is 0 or FFFFFFFF
	1	0	-	Poor fan motor operation	Disconnecting the fan motor connector / Failure of indoor fan motor lock
	1	7	-	Inlet Air temperature sensor of FAU	Air temperature sensor of indoor unit is open or short
Outdoor unit related error	2	1	*	Master Outdoor Unit Inverter Compressor IPM Fault	Master Outdoor Unit Inverter Compressor Drive IPM Fault
	2	2	*	Inverter Board Input Over Current(RMS) of Master Outdoor Unit	Master Outdoor Unit Inverter Board Input Current excess (RMS)
	2	3	*	Master Outdoor Unit Inverter Compressor DC link Low Voltage	DC charging is not performed at Master Outdoor Unit after starting relay turn on.
	2	4	*	Master Outdoor Unit High Pressure Switch	System is turned off by Master Outdoor Unit high pressure switch.
	2	5	*	Master Outdoor Unit Input Voltage High/ Low Voltage	Master Outdoor Unit input voltage is over 487V or below 270V
	2	6	*	Master Outdoor Unit Inverter Compressor Start Failure	The First Start Failure by Master Outdoor Unit Inverter Compressor Abnormality
	2	9	*	Master Outdoor Unit Inverter Compressor Over Current	Master Outdoor Unit Inverter Compressor Fault OR Drive Fault
	3	2	*	Master Outdoor Unit Inverter Compressor1 High Discharge Temperature	Master Outdoor Unit Inverter Compressor1 High Discharge Temperature
	3	3	*	Master Outdoor Unit Inverter Compressor2 High Discharge Temperature	Master Outdoor Unit Inverter Compressor2 High Discharge Temperature
3	4	*	High Pressure of Master Outdoor Unit	High Pressure of Master Outdoor Unit	

Display				Title	Cause of Error
Outdoor unit related error	3	5	*	Low Pressure of Master Outdoor Unit	Low Pressure of Master Outdoor Unit
	3	6	*	Master Outdoor Unit Low Compression Ratio Limited	Master Outdoor Unit Low Compression Ratio Limited
	4	0	*	Master Outdoor Unit Inverter Compressor CT Sensor Fault	Master Outdoor Unit Inverter Compressor CT Sensor open or short
	4	1	*	Master Outdoor Unit Inverter Compressor1 Discharge Temperature Sensor Fault	Master Outdoor Unit Inverter Compressor Discharge Temperature Sensor open or short
	4	2	*	Master Outdoor Unit Low Pressure Sensor Fault	Master Outdoor Unit Low Pressure Sensor open or short
	4	3	*	Master Outdoor Unit High Pressure Sensor Fault	Master Outdoor Unit High Pressure Sensor open or short
	4	4	*	Master Outdoor Unit Air Temperature Sensor Fault	Master Outdoor Unit Air Temperature Sensor open or short
	4	5	*	Master Outdoor Unit Heat Exchanger Temperature Sensor (Front side) Fault	Master Outdoor Unit Heat Exchanger Temperature Sensor(Front side) open or short
	4	6	*	Master Outdoor Unit Suction Temperature Sensor Fault	Master Outdoor Unit Suction Temperature Sensor open or short
	4	7	*	Master Outdoor Unit Inverter Compressor2 Discharge Temperature Sensor Fault	Master Outdoor Unit Inverter Compressor2 Discharge Temperature Sensor open or short
	4	9	*	Master Outdoor Unit Faulty IPM Temperature Sensor	Master Outdoor Unit IPM Temperature Sensor short/open
	5	0	*	Omitting connection of R, S, T power of Master Outdoor Unit	Omitting connection of Master outdoor unit
	5	1	*	Excessive capacity of indoor units	Excessive connection of indoor units compared to capacity of Outdoor Unit
	5	2	*	Communication error : inverter PCB → Main PCB	Failing to receive inverter signal at main PCB of Master Outdoor Unit
	5	3	*	Communication error : indoor unit → Main PCB of Outdoor Unit	Failing to receive indoor unit signal at main PCB of Outdoor Unit .
	5	7	*	Communication error : Main PCB → inverter PCB	Failing to receive signal main PCB at inverter PCB of Master Outdoor Unit
	5	9	*	Mixing Installation of Sub Outdoor Unit	Mixing Installation of Old Sub Outdoor Unit and New Slave Outdoor Unit
	6	0	*	Inverter PCB EEPROM Error of Master Outdoor Unit	Access Error of Inverter PCB of Master Outdoor Unit
	6	2	*	Master Outdoor Unit Inverter Heatsink High Temperature	System is turned off by Master Outdoor Unit Inverter Heatsink High Temperature
	6	5	*	Master Outdoor Unit Inverter Heatsink Temperature Sensor Fault	Master Outdoor Unit Inverter Heatsink Temperature Sensor open or short
	6	7	*	Master Outdoor Unit Fan Lock	Restriction of Master Outdoor Unit
	7	1	*	Converter CT Sensor Error of Master Outdoor Unit	Converter CT Sensor open or short of Master Outdoor Unit
	7	5	*	Master Outdoor Unit Fan CT Sensor Error	Master Outdoor Unit Fan CT Sensor open or short
	7	6	*	Master Outdoor Unit Fan DC Link High Voltage Error	Master Outdoor Unit Fan DC Link High Voltage Error
	7	7	*	Master Outdoor Unit Fan Over Current Error	Master Outdoor Unit Fan Current is over 5A
	7	9	*	Master Outdoor Unit Fan Start Failure Error	Master Outdoor Unit Fan First Position Sensing Failure
	8	6	*	Master Outdoor Unit Main PCB EEPROM Error	Communication Fail Between Master Outdoor Unit Main MICOM and EEPROM or omitting EEPROM
	8	7	*	Master Outdoor Unit Fan PCB EEPROM Error	Communication Fail Between Master Outdoor Unit Fan MICOM and EEPROM or omitting EEPROM

Outdoor unit related error	1	0	4	*	Communication Error Between Master Outdoor Unit and Other Outdoor Unit	Failing to receive Slave Unit signal at main PCB of Master Outdoor Unit
	1	0	5	*	Master Outdoor Unit Fan PCB Communication Error	Failing to receive fan signal at main PCB of Master unit.
	1	0	6	*	Master Outdoor Unit FAN IPM Fault Error	Instant Over Current at Master Outdoor Unit Fan IPM
	1	0	7	*	Master Outdoor Unit Fan DC Link Low Voltage Error	Master Outdoor Unit Fan DC Link Input Voltage is under 380V
	1	1	3	*	Master Outdoor Unit Liquid pipe Temperature Sensor Error	Liquid pipe temperature sensor of Master Outdoor Unit is open or short
	1	1	4	*	Master Outdoor Unit Subcooling Inlet Temperature Sensor Error	Master Outdoor Unit Subcooling Inlet Temperature Sensor Error
	1	1	5	*	Master Outdoor Unit Subcooling Outlet Temperature Sensor Error	Master Outdoor Unit Subcooling Outlet Temperature Sensor Error
	1	1	6	*	Master Outdoor Unit Oil Level Sensor Error	Oil Level Sensor of Master Outdoor Unit is open or short
	1	4	5	*	Master outdoor unit Main Board - External Board communication Error	Master outdoor unit Main Board - External Board communication Error
	1	5	1	*	Failure of operation mode conversion at Master Outdoor Unit	Failure of operation mode conversion at Master Outdoor Unit
	1	5	3	*	Master Outdoor Unit Heat Exchanger Temperature Sensor (upper part) Fault	Master Outdoor Unit Heat Exchanger Temperature Sensor (upper part) Fault
	1	5	4	*	Master Outdoor Unit Heat Exchanger Temperature Sensor (lower part) Fault	Master Outdoor Unit Heat Exchanger Temperature Sensor(lower part) open or short
	1	8	2	*	Master outdoor unit External Board Main-Sub Micom communication Error	Master Outdoor Unit Main Board Main-Sub Micom communication failed
	1	8	7	*	Hydro - Kit P,HEX bursting error	Inlet water temperature is below 5 degree or water temperature error during defrosting operation.
	HR Unit related error	2	0	0	1	Searching pipe Error
2		0	1	C+#HR	HR unit1 Liquid sensor error	Liquid pipe sensor of HR unit open or short
2		0	2	C+#HR	HR unit1 Sub Cooling Pipe sensor error	Sub Cooling Pipe In sensor of HR unit open or short
2		0	3	C+#HR	HR unit1 Sub Cooling Pipe Out sensor error	Sub Cooling Pipe Out sensor of HR unit. open or short
2		0	4	C+#HR	Communication error	Failing to receive HR unit signal at outdoor unit

C: HR unit  
#: HR unit Number

## CAUTION FOR REFRIGERANT LEAK

The installer and system specialist shall secure safety against leakage according to local regulations or standards. The following standards may be applicable if local regulations are not available.

### Introduction

Though the R410A refrigerant is harmless and incombustible itself, the room to equip the air conditioner should be large to such an extent that the refrigerant gas will not exceed the limiting concentration even if the refrigerant gas leaks in the room.

### Limiting concentration

Limiting concentration is the limit of Freon gas concentration where immediate measures can be taken without hurting human body when refrigerant leaks in the air. The limiting concentration shall be described in the unit of kg/m<sup>3</sup> (Freon gas weight per unit air volume) for facilitating calculation.

Limiting concentration: 0.44kg/m<sup>3</sup>(R410A)

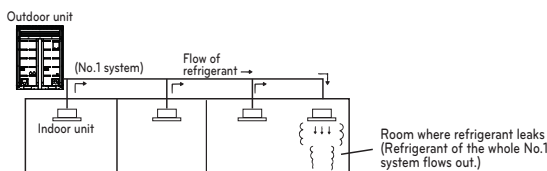

## Checking procedure of limiting concentration

Check limiting concentration along following steps and take appropriate measure depending on the situation.

### Calculate amount of all the replenished refrigerant (kg) per each refrigerant system.

$$\begin{matrix} \text{Amount of replenished} \\ \text{refrigerant per one outdoor} \\ \text{unit system} \end{matrix} + \begin{matrix} \text{Amount of additional} \\ \text{replenished refrigerant} \\ \text{depending on piping} \\ \text{length or piping} \\ \text{diameter at customer} \end{matrix} = \begin{matrix} \text{Total amount of replenished} \\ \text{refrigerant in refrigerant} \\ \text{facility (kg)} \end{matrix}$$

Note : In case one refrigerant facility is divided into 2 or more refrigerant systems and each system is independent, amount of replenished refrigerant of each system shall be adopted.

### Calculate minimum room capacity

Calculate room capacity by regarding a portion as one room or the smaller room.

- Without partition

- With partition and with opening which serve as passage of air to adjoining room

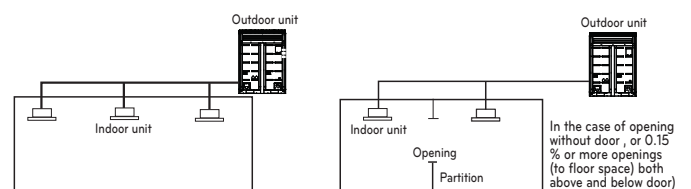

- With partition and without opening which serve as passage of air to adjoining room

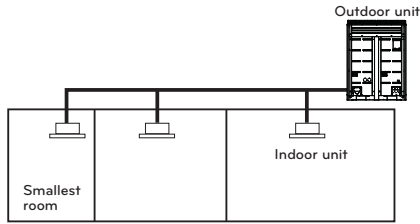

#### Calculate refrigerant concentration

$$\frac{\text{Total amount of replenished refrigerant in refrigerant facility (kg)}}{\text{Capacity of smallest room where indoor unit is installed (m}^3\text{)}} = \text{Refrigerant concentration (kg/m}^3\text{)} \quad (\text{R410A})$$

- In case the result of calculation exceeds the limiting concentration, perform the same calculations by shifting to the second smallest, and the third smallest rooms until at last the result is below the limiting concentration.

#### In case the concentration exceeds the limit

When the concentration exceeds the limit, change original plan or take one of the countermeasures shown below:

- Countermeasure 1  
Provide opening for ventilation.  
Provide 0.15% or more opening to floor space both above and below door, or provide opening without door.
- Countermeasure 2  
Provide gas leak alarm linked with mechanical ventilator.  
Reducing the outdoor refrigerant qty.

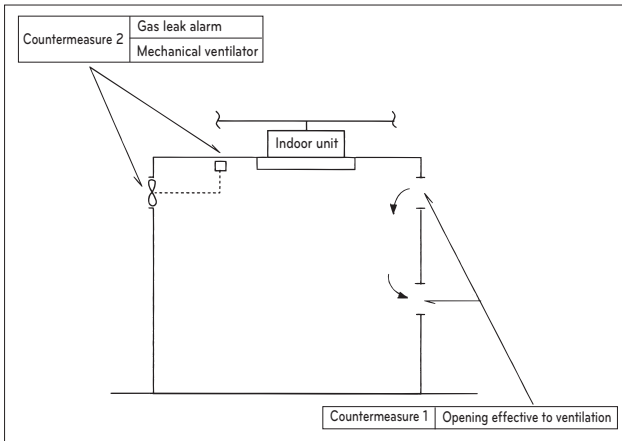

Pay a special attention to the place, such as a basement, etc. where refrigerant can stay, since refrigerant is heavier than air.

## INSTALLATION GUIDE AT THE SEASIDE

### CAUTION

- Air conditioners should not be installed in areas where corrosive gases, such as acid or alkaline gas, are produced.
- Do not install the product where it could be exposed to sea wind (salty wind) directly. It can result corrosion on the product. Corrosion, particularly on the condenser and evaporator fins, could cause product malfunction or inefficient performance.
- If outdoor unit is installed close to the seaside, it should avoid direct exposure to the sea wind. Otherwise it needs additional anticorrosion treatment on the heat exchanger.

#### Selecting the location(Outdoor Unit)

If the outdoor unit is to be installed close to the seaside, direct exposure to the sea wind should be avoided. Install the outdoor unit on the opposite side of the sea wind direction.

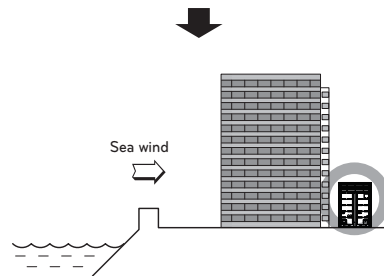
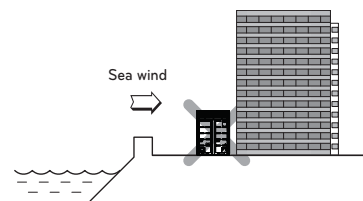

In case, to install the outdoor unit on the seaside, set up a windbreak not to be exposed to the sea wind.

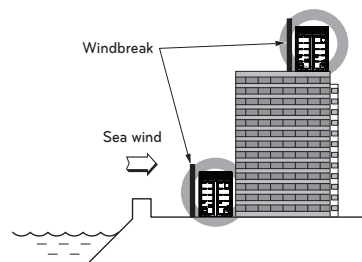

- It should be strong enough like concrete to prevent the sea wind from the sea.
- The height and width should be more than 150% of the outdoor unit.
- It should be keep more than 70 cm of space between outdoor unit and the windbreak for easy air flow.

Select a well-drained place.

- Periodic ( more than once/year ) cleaning of the dust or salt particles stuck on the heat exchanger by using water

## Model Designation

### Product information

• Product Name : Air conditioner

• Model Name :

Product Sales Name	Model Factory Name
ARUx***LTy4 series	
x = N, B (Heat pump), V (Cooling only)	
y = S (Basic function), E (Additional function related to performance)	
*** = Numeric; (Cooling capacity)	

• Additional information : Serial number is refer to the bar code on the product.

## Airborne Noise Emission

The A-weighted sound pressure emitted by this product is below 70 dB.

\*\* The noise level can vary depending on the site.

The figures quoted are emission level and are not necessarily safe working levels.

Whilst there is a correlation between the emission and exposure levels, this cannot be used reliably to determine whether or not further precautions are required.

Factor that influence the actual level of exposure of the workforce include the characteristics of the work room and the other sources of noise, i.e. the number of equipment and other adjacent processes and the length of time for which an operator exposed to the noise. Also, the permissible exposure level can vary from country to country.

This information, however, will enable the user of the equipment to make a better evaluation of the hazard and risk.



