



Owner's Manual

LG CineBeam

DLP Projector

Please read the safety information carefully before using this product.

PF1500

www.lg.com

P/NO : SAC37034604 (1805-REV03)

Copyright © 2017 LG Electronics Inc. All Rights Reserved.

LICENSES

Supported licenses may differ by model. For more information about licenses, visit www.lg.com.



Manufactured under license from Dolby Laboratories. Dolby and the double-D symbol are trademarks of Dolby Laboratories.



This DivX Certified® device has passed rigorous testing to ensure it plays DivX® video.

To play purchased DivX movies, first register your device at vod.divx.com. Find your registration code in the DivX VOD section of your device setup menu. DivX Certified® to play DivX® video up to HD 1080p, including premium content. DivX®, DivX Certified® and associated logos are trademarks of DivX, LLC and are used under license.

Covered by DivX Patents 7,295,673; 7,515,710; RE45,052; and others available at [www.divx.com/patents]



The terms HDMI and HDMI High-Definition Multimedia Interface, and the HDMI logo are trademarks or registered trademarks of HDMI Licensing LLC in the United States and other countries.



For DTS patents, see <http://patents.dts.com>. Manufactured under license from DTS Licensing Limited. DTS, the Symbol, & DTS and the Symbol together are registered trademarks, and DTS 2.0+Digital Out is a trademark of DTS, Inc. © DTS, Inc. All Rights Reserved.

**NOTE**

- Image shown may differ from your projector.
- Your projector's OSD (On Screen Display) may differ slightly from that shown in this manual.

SAFETY PRECAUTIONS

Please take note of the safety instructions to prevent any potential accident or misuse of the projector.

- Safety precautions are given in two forms, i.e., **WARNING** and **CAUTION** as detailed below.

 **WARNING** Failure to follow the instructions may cause serious injury and even death.

 **CAUTION** Failure to follow the instructions may cause personal injury or product damage.

- Read the owner's manual carefully and keep it on hand.



 The lightning flash with arrowhead symbol, within an equilateral triangle, is intended to alert the user to the presence of uninsulated dangerous voltage within the product's enclosure that may be of sufficient magnitude to constitute a risk of electric shock to persons.

 The exclamation point within an equilateral triangle is intended to alert the user to the presence of important operating and maintenance (servicing) instructions in the literature accompanying the appliance.

WARNING/CAUTION

- TO REDUCE THE RISK OF FIRE AND ELECTRIC SHOCK, DO NOT EXPOSE THIS PRODUCT TO RAIN OR MOISTURE.

**Read these instructions.
Keep these instructions.
Heed all warnings.
Follow all instructions.**

Indoor Installation

WARNING

- Do not use the projector outside and do not expose the product to any humidity or water.
 - Since the product is not waterproof, this may result in a fire or electric shock.
- Do not place the projector in direct sunlight or near heat sources such as radiators, fires, stoves, etc.
 - This may result in fire.
- Do not place flammable materials such as aerosols near the projector.
 - This may result in fire.
- Do not allow children to cling to or climb up to the projector.
 - This may cause the projector to fall, causing injury or death.

- Do not install the product in a place with no ventilation (e.g., on a bookshelf or in a closet) or on a carpet or cushion.
 - This may result in fire due to the increase in internal temperature.
- Do not place the product close to sources of steam, oil or oil mist, such as humidifiers and kitchen counters.
 - Failure to do so may result in fire, electric shock, or corrosion.
- Do not install the product onto a wall or ceiling that is close to sources of oil or oil mist.
 - The product may be damaged and fall, resulting in serious injury.
- Do not place the projector where it might be exposed to dust.
 - This may result in fire.
- Do not use the projector in a damp place such as a bathroom where it is likely to get wet.
 - This may result in fire or electric shock.
- Do not allow a tablecloth or curtain to block the air vent.
 - This may result in fire due to the increase in the internal temperature.
- Ensure good ventilation around the projector. The distance between the projector and the wall should be at least 30 cm.
 - This will prevent fire due to the increase in the internal temperature.

CAUTION

- When placing the projector on a table or shelf, be careful not to put it near the edge.
 - The projector could fall due to balance problems, which may cause personal injury or damage to the product. Make sure to use the projector cabinet or stand that fits the projector.
- When moving the projector, make sure to switch it off and remove the power plug and cords.
 - The power cord may be damaged, resulting in fire or electric shock.
- Do not place the projector on an unstable or vibrating surface such as a wobbly shelf or a slope.
 - It may fall and cause injury.
- Be careful not to tip the projector over when connecting external devices to the projector.
 - This may cause personal injury or damage to the projector.

Power

WARNING

- The appliance coupler is used as the disconnect device.
 - Please make sure the device is installed near the wall outlet to which it is connected and that the outlet is easily accessible.

- The grounding wire should be connected.
 - Ensure that you connect the grounding cable to avoid electric shock. If it is not possible to ground the unit, have a qualified electrician install a separate circuit breaker.
Do not try to ground the projector by connecting it to telephone wires, lightning rods or gas pipes.
- The power plug should be inserted fully into the power outlet.
 - An unstable connection may cause a fire.
- Do not place heavy objects on the power cord.
 - This may result in fire or electric shock.
- Never touch the power plug with wet hands.
 - This may result in electric shock.
- Do not plug too many devices into one multi-power outlet.
 - This may result in fire due to the power outlet overheating.
- Prevent dust from collecting on the power plug pins or outlet.
 - This may result in fire.
- To turn off the main power, remove the power plug, which should be positioned so it is easy to access for operation.

CAUTION

- Hold the plug firmly when unplugging.
 - A damaged wire may create a fire hazard.
- Ensure the power cord and plug are not damaged, modified, severely bent, twisted, pulled, sandwiched or hot. Do not use the product if the power outlet is loose.
 - This may result in fire or electric shock.
- Keep the power cord away from heating devices.
 - The wire's sheath may melt, which may result in fire or electric shock.
- Place the projector where people will not trip over or step on the power cord to protect the power cord and plug from any damage.
 - This may result in fire or electric shock.
- Do not turn the projector on or off by plugging in the power plug or unplugging it from the power outlet. (Do not use the power plug as a switch.)
 - This may result in electric shock or damage to the product.

- Do not insert a conductor into the other side of the wall outlet while the power plug is inserted into the wall outlet. In addition, do not touch the power plug immediately after it is disconnected from the wall outlet.
 - This may result in electric shock.
- Only use the official power cord provided by LG Electronics. Do not use other power cords.
 - This may result in fire or electric shock.
- Do not insert pieces of metal such as coins, hairpins or metal debris, nor flammable materials such as paper or matches into the projector.
 - This is to prevent electric shock or fire.
- In the event that liquid or a foreign object falls into the projector, switch it off and unplug it from the power outlet and contact our service center.
 - This may result in fire or electric shock.
- Make sure that a child does not swallow the batteries when you replace the old remote control batteries with new ones. Keep batteries out of reach of children.
 - If a child swallows a battery, consult a doctor immediately.

When in Use

WARNING

- Do not place anything containing liquid on top of the projector such as a vase, flower pot, cup, cosmetics, or medicine; or ornaments, candles, etc.
 - This may result in fire or electric shock, or cause injury due to falling.
- In the event that there is a heavy impact or the cabinet is damaged, switch it off, unplug it from the power outlet and contact an authorized service center.
 - This may result in electric shock.
- Do not look directly into the lens when the projector is in use.
 - The bright light may damage your eyes.
- When the lamp is on or has just been turned off, avoid touching the air vent or lamp, because these will be very hot.
- If there is a gas leak in the room with the projector, do not touch the projector or power outlet. Open the windows for ventilation.
 - Sparks may cause fire or burns.

- Unplug the power cord from the outlet during a lightning storm.
 - This will prevent shock or damage to the projector.
- Do not use the projector near electronic devices that generate a strong magnetic field.
- Do not put the plastic package used to pack the projector around your head.
 - This may cause suffocation.
- Do not keep your hand on the projector for a long time when it is running.
- When you play a game by connecting a game console to a projector, it is recommended that you maintain a distance of more than four times the diagonal length of the screen.
 - Make sure that the connecting cable is long enough. Otherwise, the product may fall causing personal injury or damage to the product.
- Do not place the projector or its remote control with battery in an extremely high temperature environment.
 - This may result in fire.

CAUTION

- Do not place heavy objects on the projector.
 - It may fall down and cause personal injury.
- Be careful not to allow any impact to the lens during transport.
- Do not touch the lens of the projector.
 - The lens may be damaged.
- Do not use any sharp tools on the projector such as a knife or hammer, because this may damage the casing.
- In the event that no image appears on the screen or no sound is heard, stop using the projector. Switch off the projector, unplug it from the power outlet and contact our service center.
 - This may result in fire or electric shock.
- Do not drop anything onto the projector or allow anything to bang into the projector.
 - This may cause damage to the projector or personal injury.
- It is recommended that you maintain a distance of at least 5-7 times the diagonal length of the screen.
 - If you watch the screen at a close distance for a long time, your eye sight may become worse.

- Do not block the light beam emitted from the projector using a book or other object.
 - Lengthy exposure to the projector beam may result in fire. In addition, the lens may be overheated and damaged by the reflected heat. Disable the AV function to stop projection temporarily or turn off the power.
- Do not start the projector with the volume turned up high.
 - High volume may damage hearing.
- Do not use high voltage electrical equipment near the projector, (e.g., a bug zapper.). This may result in product malfunction.
- Use air spray, a soft cloth or a cotton swab moistened with a lens cleaning chemical or alcohol to remove dust or stains on the front projection lens.

CAUTION

- Contact your seller or our service center once a year to clean the internal parts of the projector.
 - If you do not clean the projector for a long period of time, dust will accumulate, which may result in fire or damage to the projector.
- When cleaning plastic parts such as the projector case, unplug the power first and wipe with a soft cloth. Do not spray with water or wipe with a wet cloth. Never use glass cleaner, automobile or industrial shiner, abrasives, wax, benzene, or alcohol as these can damage the projector.
 - This can result in fire, electric shock or cause damage to the product (deformation and corrosion).
- Do not wipe the optical system (lens, mirror) right after the product has been turned off or while the product is being operated. When cleaning each part of the product, remove the power cord and wipe gently with a soft cloth. Do not spray with water or wipe with a wet cloth. Do not use detergents,

Cleaning

WARNING

- Do not spray the projector with water when cleaning. Make sure water does not flow into the projector.
 - This may result in fire or electric shock.
- When there is smoke or a strange smell coming out from the projector or a foreign object falls into the projector, please switch it off and unplug it from the power outlet and contact our service center.
 - Otherwise, this may result in fire or electric shock.

automobile or industrial polish, abrasive substances, wax, benzene, alcohol, water, etc. on the product's main unit or optical system (lens, mirror) as this may damage the product.

- This can result in fire, electric shock or cause damage to the product (deformation and corrosion).
- Remove the plug from the outlet before cleaning the product.
 - Otherwise, this may result in electric shock.

Others

WARNING

- When you go out, place the projector out of reach of animals, and remove the power plug from the wall outlet.
 - Using a damaged power cord may result in short circuit or fire.
- Do not use the projector near highprecision electronic devices or those that transmit weak radio signals.
 - This may affect the operation of the product, causing an accident.
- Only a qualified technician can disassemble or modify the projector. For diagnosis, adjustment, or repair, contact your seller or our service center.
 - This may result in fire or electric shock.
- Do not stare directly into lens when in operation, eye damage can occur.
- No user serviceable parts inside unit. High voltage parts can cause shock and even electrocution.
- Proper ventilation required, do not block airflow around unit. Doing so can cause injury and internal overheating.
- Do not touch the lens; doing so can result in burns or damage to lens. Lens and unit may be HOT during and immediately after use. Use caution when handling unit, allowing for proper cool down.
- Only use a grounded electrical outlet.
- Do not insert anything into or cover up the exhaust vents.
 - This may result in fire or electric shock.
- Follow all maintenance guidelines for optimal use; service only at an authorized service center.

 **CAUTION**

- Do not mix new batteries with old ones.
 - Burst or leaking batteries may result in damage or injury.
- Be sure to unplug if the projector is not to be used for a long period.
 - Accumulated dust may result in fire or electric shock due to overheating, ignition, or poor insulation.
- Only use the specified type of battery.
 - Burst or leaking batteries may result in damage or injury.
- Dispose of used batteries properly.
 - This may result in explosion or fire. The correct method of disposal may vary depending on your country or region. Dispose of the battery pack as instructed.
- Do not throw or disassemble the battery.
 - This may result in fire or explosion due to damage to the battery.
- Store batteries away from metallic objects, such as keys and paper clips.
 - Excess current may cause a rapid increase in temperature, resulting in fire or burns.
- Do not store the batteries near any heat source, such as a heater.
 - This may result in fire or damage to the product.
- Do not store batteries at temperatures higher than 60 °C or in high humidity.
 - This may result in explosion or fire.
- Keep the batteries and remote out of reach of children.
 - This will prevent personal injury or damage to the product.
- Make sure that the battery is installed correctly.
 - This prevent explosion or fire.
- Make sure you use the same type of batteries for replacement.
- Incorrect battery replacement may cause fire.

Antenna

WARNING

- If you are using an outdoor antenna, please install it away from electrical wires to make sure it does not touch any nearby wires even when it falls down due to heavy wind.
- Failure to do so may cause electric shock or physical injury.

CAUTION

- To prevent any water flowing into the product, install a drip loop in the outdoor antenna wire where it comes indoors.
- Raindrops flowing into the product may cause fire or electric shock.

Antenna grounding according to the National Electrical Code, ANSI/NFPA 70

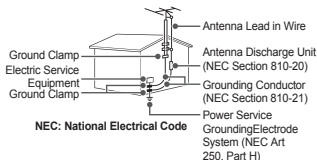

For USA

NOTE TO CABLE/TV INSTALLER

This reminder is provided to call the CATV system installer's attention to Article 820 - 40 of the National Electric Code (USA). The code provides guidelines for proper grounding and, in particular, specifies that the cable ground shall be connected to the grounding system of the building, as close to the point of the cable entry as practical.

Risk Group 2

CAUTION Possibly hazardous optical radiation emitted from this product. Do not stare at operating lamp. May be harmful to the eye.

CONTENTS

LICENSES	2	USING THE PROJECTOR	32
SAFETY PRECAUTIONS	4	Connecting the Antenna or Cable	32
PREPARATION	16	Watching Projector	33
Accessories	16	– Initial Setup	33
Optional Extras	17	– Focus and Position of the Screen Image	36
Parts and Components	18	– Watching With the Projector	37
– Main Unit	18	To Set Channel	38
– Side	19	– To View Program Information	38
– Back	20	– To Set Favorite Channels	38
Using the Joystick Button	21	– To Use Favorite	39
– Basic functions	21	– To Set Auto Tuning	39
– Adjusting the menu	22	– To Set Channels Manually	39
Projector Status Indicators	22	– To Edit Channels	39
Installation	23	Additional Options	40
– Installation Precautions	23	– To adjust Aspect Ratio	40
– Projection Distance per Screen Size	24	– Using the Edge Adj (4 Corner Keystone) Function	41
– How to Install the Projector On a Tripod	26	– Changing Input Device	42
– Kensington Security System	27	– To Use SIMPLINK	44
MAGIC REMOTE CONTROL	28	Using the Quick Menu	46
– To Register the Magic Remote Control	30	To Set Sound	47
– To Re-register the Magic Remote Control	30	– To Set Sound Output	47
– Using the Magic Remote Control	31	– Using the Multi Audio	48
		ENTERTAINMENT	50
		To use Smart Features	50
		– To use Home Screen	50
		– To use MY APPS	51
		– To edit items in MY APPS	51

To Connect Network	52	To Use a Premium Service	70
– One-click Network Connection	52	– To Use Paid Content	71
– To Connect to a Network Through Set Expert	52	– To Reset Premium	72
– To Use the Wi-Fi Direct Function	53	To Use LG Smart World	73
– Tips for Network Settings	54	– To Sign Up With LG Smart World	74
		– To Install An App On Your Projector	74
		– To Manage My Information	75
SMARTSHARE	55	To Use Search Function	76
Before Using	55	To Use the Voice Recognition Function	77
– Connecting a USB Device	55	– Using this Function Through Search	77
– Removing a USB Device	55	– Using this Function on the Internet	77
To use SmartShare™	57	To Use Voice Mate Function	79
– Watching the Videos	58	– What Is Voice Mate?	79
– Viewing the Photos	60	– How to Use Voice Mate?	80
– Listening to Music	61	– What Are Other Functions of Voice Mate?	80
– Viewing Files	62	See Avatar	81
– To Set SmartShare™ Related Functions	63	– Using the Avatar	81
To use SCREEN SHARE (Miracast™ / Intel's WiDi Function)	65	What Is On Now?	82
– To Use the Miracast™ / Intel's WiDi Function	65	– To Use On Now	82
To connect DLNA	66	To Use Internet	85
– To connect a DLNA-authenticated Smartphone	66	Frequently Asked Questions for Projector	86
– To connect DLNA DMR (Digital Media Renderer)	67		
– To connect a DLNA DMP (Digital Media Player)	67	USING ADVANCED FUNCTIONS	91
– SmartShare™ PC SW Installing and Setting	68	To Use Screen Remote	91
– In Case of a DLNA Malfunction	69	– To Use Screen Remote	91
		– To Control a Device Connected to the Projector Using the Screen Remote	91

To Use the Universal Control
function 92

To Control a Projector Using a
Smartphone 93

To Use a USB Input Device On
a Projector 94

– To Use a USB Wired/wireless
Mouse 94

– To Use a USB Wired/wireless
Keyboard 94

CUSTOMIZING SETTINGS 95

SETTINGS 95

PICTURE Settings 96

SOUND Settings 102

CHANNEL Settings 105

TIME Settings 106

LOCK Settings 107

OPTION Settings 111

NETWORK Settings 116

SUPPORT 118

CONNECTING DEVICES 119

Connecting to HD Receiver,
DVD, or VCR Player, External
Devices 120

– HDMI Connection 120

– HDMI to DVI Connection 121

– AV Connection 121

– Component Connection 122

Connecting a PC 123

– HDMI Connection 123

– HDMI to DVI Connection 123

Connecting a Laptop 124

– HDMI Connection 124

Connecting Headphones 125

Connecting a Digital Amp 126

**Using the Mirroring Function
of a Mobile Phone** 127

– MHL Connection 127

MAINTENANCE 128

Cleaning 128

– Cleaning the Lens 128

– Cleaning the Projector Case
128

INFORMATION 129

To Update Projector Software
129

Before Reporting a Problem,
Check the Following: 130

– General 130

– Picture 130

– Sound 131

– PC Connection Problem 133

– Problems Replaying Movies
in My Media 134

SPECIFICATIONS 135

SYMBOLS 140

PREPARATION

The pictures may differ slightly from the actual product.

Accessories

Accessories included with the projector are show below.

Accessories are subject to change without prior notice.

New accessories may be added or old ones removed.

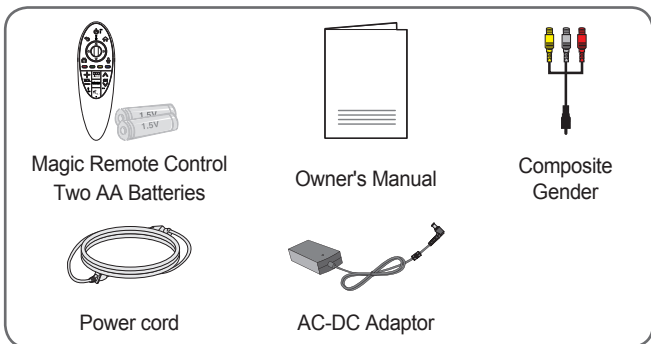

- When connecting an HDMI or USB cable, or connecting a USB flash drive to the HDMI or USB port, use a product that has a width of 18 mm or less and a height of 10 mm or less. If the USB cable or USB flash drive does not fit the USB ports of the projector, use an extension cable that supports USB 2.0.

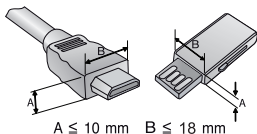

- When connecting two USB devices at the same time, each one should have bezels less than 8.5 mm thick.
- Use a certified cable with the HDMI logo attached.
- If you do not use a certified HDMI cable, the screen may not display or a connection error may occur. (Recommended HDMI cable types)
 - High-Speed HDMI[®]/TM Cable
 - High-Speed HDMI[®]/TM Cable with Ethernet

Optional Extras

To purchase optional accessories, visit an electronics store or online shopping site or contact the retail store where you purchased the product. Optional accessories are subject to change without prior notice.



Projection Screen



Tripod



HDMI Cable



Video Cable



Audio Cable



RF Cable



Optical Cable

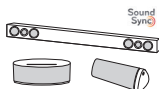

LG Audio Device



MHL Cable

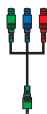

Component Gender

Parts and Components

This projector is manufactured using high-precision technology. You may, however, see tiny black dots and/or bright colored dots (red, blue, or green) that continuously appear on the projector screen. This is a normal result of the manufacturing process and does not indicate a malfunction.

Main Unit

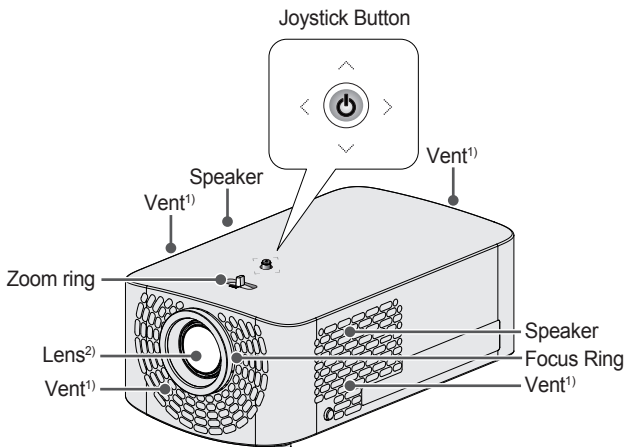

1) Due to the high temperature of vent area, do not get close to the vent area.

2) Do not touch the lens when using the projector. The lens may be damaged.

Side

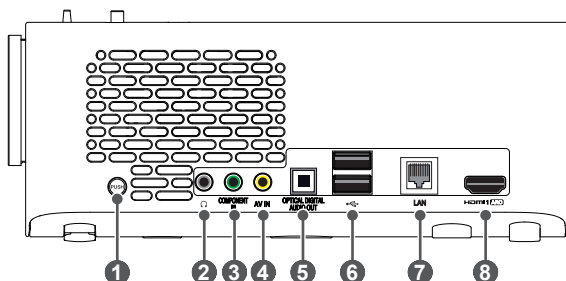

	Description
1	PUSH button
2	🎧 (Headphone Port)
3	COMPONENT IN Port
4	AV IN Port
5	OPTICAL DIGITAL AUDIO OUT Port
6	🔌 (USB port)
7	LAN Port
8	HDMI 1 ARC Port

Back

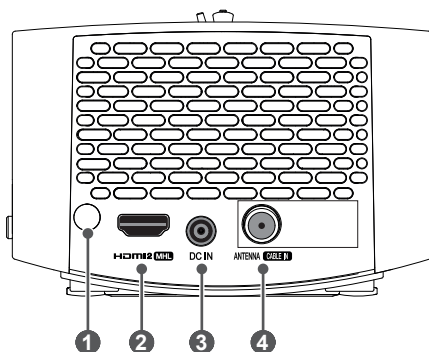





No.	Description
1	IR Receiver
2	HDMI2 MHL Port
3	DC IN Port
4	ANTENNA CABLE IN Port

Using the Joystick Button

You can operate the projector by pressing the button or moving the joystick left, right, up, or down.

Basic functions

	Power On	When the projector is turned off, place your finger on the joystick button, press it once, and release it.
	Power Off	When the projector is turned on, place your finger on the joystick button, press it once for a few seconds, and release it. (However, if the Menu button is on the screen, pressing and holding the joystick button will let you exit the Menu.)
	Volume Control	Place your finger over the joystick button and move it left or right, you can adjust the volume level.
	Channels Control	Place your finger over the joystick button and move it up or down, you can scroll through the saved channels.



NOTE

- Place your finger over the joystick button and move it up, down, left, or right. Be careful not to press the joystick button. If you press the joystick button first, you may not be able to adjust the volume level and/or scroll through saved channels.

Adjusting the menu

When the projector is turned on, press the joystick button one time.

You can adjust the menu items (⏻, 📺, ✕, ⚙️) moving the joystick button left, right, up, or down. Move to the desired menu item, and then press the joystick button once to select it.

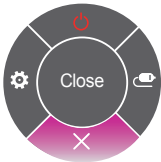
	⏻	Projector off	Turns the power off.
	📺	Input List	Changes the input source.
	✕	Close	Clears on-screen displays and returns to projector viewing.
	⚙️	Settings	Displays the Settings menu.

Projector Status Indicators

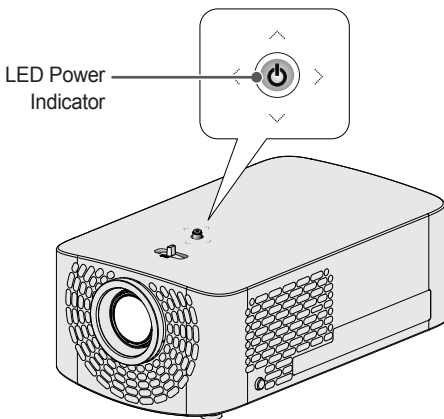

LED Power Indicator	
Red	Power standby state
Off	The projector is operating with the power on.

Installation

Installation Precautions

- Place the projector in a well-ventilated environment.
 - To prevent internal overheating, install the projector in a well-ventilated place. Do not place anything near the projector. That may block its air vents. If the air vents are blocked, the internal temperature of the projector will increase.

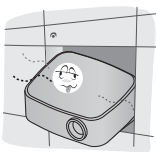

- Do not place the projector on a carpet or rug. If the projector's inlet vent is on the bottom, be careful not to block the vent and always use the projector on a solid, level surface.



- Be sure to prevent foreign objects such as paper debris from entering the projector.



- Leave an adequate open area (30 cm or more) around the projector.



- Do not place the projector in a hot, cool, or humid environment.
- Do not place the projector in a place where it will easily attract dust.
 - This may result in fire.
- Never open any cover on the projector. There is a high risk of electric shock.
- The projector is manufactured using high-precision technology. You may, however, see tiny black dots and/or bright colored dots (red, blue or green) that continuously appear on the projector screen. This is a normal result of the manufacturing process and does not indicate a malfunction.
- The remote control may not work in an environment where a lamp equipped with electronic ballasts or a three-wavelength fluorescent lamp is installed. Replace the lamp with an international standard lamp for the remote control to work normally.

Projection Distance per Screen Size

- 1 Place the projector on a sturdy, level surface, together with the PC or audio/video source.
- 2 Place the projector an appropriate distance away from the screen. The distance between the projector and the screen determines the actual size of the image.
- 3 Position the projector so that the lens is at a right angle to the screen. If the projector is not at a right angle, the projected image will look distorted. To correct the distortion, use the Edge Adj function. (See page 41.)
- 4 Connect the power cord of the projector and the connected device to the wall outlet.

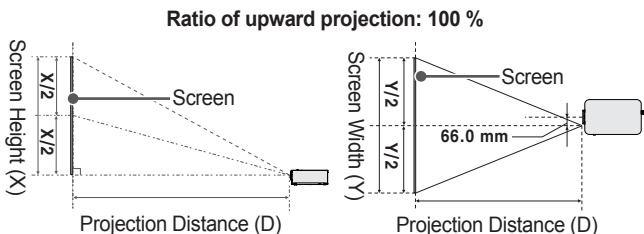

16:9 Aspect Ratio (Wide)			
Screen Size (mm)	Screen Width (Y) (mm)	Screen Height (X) (mm)	Projection Distance (D) (mm)
762	664	374	905
889	775	436	1061
1016	886	498	1230
1143	996	560	1371
1270	1107	623	1526
1397	1218	685	1682
1524	1328	747	1837
1651	1439	809	1992
1778	1550	872	2147
1905	1660	934	2302
2032	1771	996	2458
2159	1882	1058	2613
2286	1992	1121	2768
2413	2103	1183	2923
2540	2214	1245	3078
2667	2324	1308	3234
2794	2435	1370	3388
2921	2546	1432	3544
3048	2657	1494	3698

16:9 Aspect Ratio (Tele)			
Screen Size (mm)	Screen Width (Y) (mm)	Screen Height (X) (mm)	Projection Distance (D) (mm)
693	604	340	905
808	704	396	1061
924	805	453	1230
1039	906	509	1371
1155	1006	566	1526
1270	1107	623	1682
1385	1208	679	1837
1501	1308	736	1992
1616	1409	792	2147
1732	1509	849	2302
1847	1610	906	2458
1963	1711	962	2613
2078	1811	1019	2768
2194	1912	1075	2923
2309	2013	1132	3078
2425	2113	1189	3234
2540	2214	1245	3388
2655	2314	1302	3544
2771	2415	1358	3698

How to Install the Projector On a Tripod

- You can install the projector using a camera tripod.
- As shown below, you can mount the projector instead of a camera on the tripod.
- When stabilizing the tripod, we recommend using a locking bolt of standard size 4.5 mm or less. The maximum size allowed for the locking bolt is 5.5 mm. (If it is longer than the maximum allowed size, it may damage the projector.)

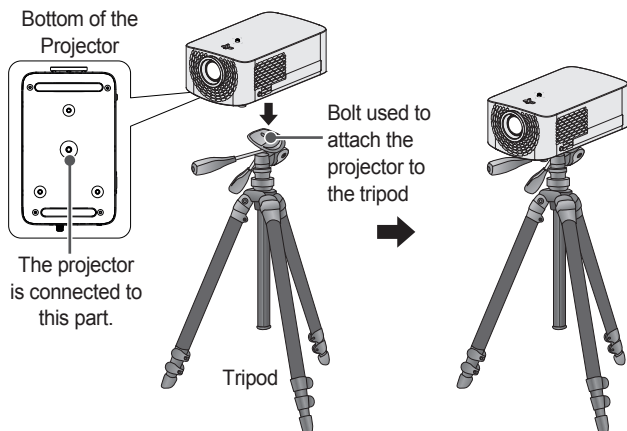

CAUTION

- If you are using a tripod, be careful not to apply external force to the tripod. Doing so may damage the projector.
- Do not place the tripod on an unstable surface.
- Be sure to use a tripod with a maximum load capacity of 3 kg or more.
- To use the projector safely, position the tripod legs so that they are as wide and stable as possible and be sure to securely attach the projector to the tripod.

Kensington Security System

- This projector has a Kensington Security Standard connector as an anti-theft mechanism. Connect a Kensington Security System cable as shown below.
- For more information on installation and use of the Kensington Security System, refer to the user's guide provided with the Kensington Security System.
- The Kensington Security System is an optional accessory.
- What is Kensington?

Kensington is a company that provides safety systems for laptops and other electronic devices. Website: <http://www.kensington.com>

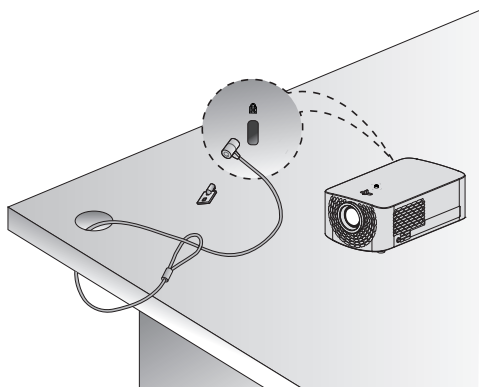

MAGIC REMOTE CONTROL

If the battery low message appears while using the Projector, replace the batteries.

As shown in the figure, press the top of the battery cover and slide it down the cover. Insert two new and identical batteries (1.5 V, AA type) with + and - poles pointing in the correct direction in the remote control.

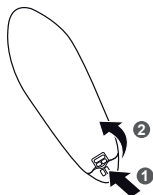

NOTE

- Do not mix new batteries with old ones.

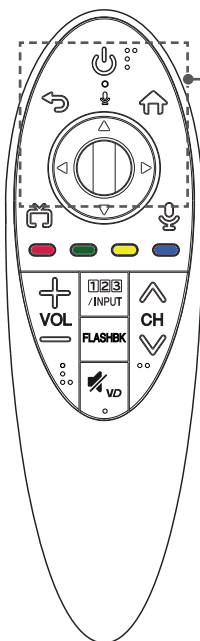

(POWER)

Turns the Projector on or off.

(Up/Down/Left/Right)

Press the up, down, left or right button to scroll the menu.

If you press  buttons while the pointer is in use, the pointer will disappear from the screen and Magic Remote will operate like a general remote control. To display the pointer on the screen again, shake Magic Remote to the left and right.

(BACK)

Returns to the previous screen.

(Home)

Accesses the Home menu.

Wheel (OK)

Press the center of the Wheel button to select a menu. You can change channels by using the Wheel button.

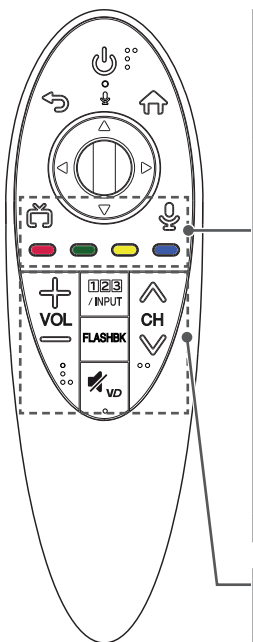

(EXIT to LIVE)

Switches among broadcast (antenna) and various inputs.

(Voice recognition)

Network connection is required to use the voice recognition function.

1. Press the voice recognition button.
2. Speak when the voice display window appears on the left of the Projector screen.

* Use the Magic Remote no further than 10 cm from your face.

* The voice recognition may fail when you speak too fast or too slowly.

* The recognition rate may vary depending on the user's characteristics (voice, pronunciation, intonation, and speed) and the environment (noise and Projector volume).

Colored buttons

These access special functions in some menus.

VOL

Adjusts the volume level.

/INPUT

Displays the Screen Remote.

* Pressing and holding the  button will display a menu to select an external device that is connected to the Projector.

FLASHBK

Displays the channel you were watching previously.

VD (MUTE)



Mutes all sounds.

* By pressing and holding the  button, video descriptions function will be enabled.

* SAP (Secondary Audio Program) Feature can also be enabled by pressing the  button.

CH

Scrolls through the saved channels.

	
<p>1 Displayed when you press the Wheel (OK) button on the magic remote control. Check program information.</p>	<p>2 If you point and hold the pointer at the bottom left of the screen while watching projector, the MY APPS icon is displayed. Clicking the icon displays the MY APPS menu.</p>

To Register the Magic Remote Control

To use the Magic Remote control, register it with your projector first.

- 1** Put batteries into the Magic Remote and turn the Projector on.
 - 2** Point the Magic Remote at your projector and press the **Wheel (OK)** on the remote control.
- If the projector fails to register the Magic Remote, try again after turning the projector off and back on.

To Re-register the Magic Remote Control

- 1** Press the **Home** and **BACK** buttons at the same time, for five seconds, to unpair the Magic Remote with your projector.
 - 2** Press the **Wheel (OK)** button towards the projector to re-register the magic remote control.
- Pressing and holding the **EXIT to LIVE** button will let you cancel and re-register Magic Remote at once.

Using the Magic Remote Control

- Shake the magic remote control lightly when there is no pointer displayed on the screen. A pointer will be displayed on the screen.
 - The pointer disappears if the remote control is not used for a certain period of time.
- When you move the pointer signal transmitter up/down/left/right while pointing it toward the projector, the pointer moves.
 - If the pointer is not working properly, do not move the magic remote control for about 10 seconds, and then try again.
- If you press the navigation button while moving the pointer on the screen, the pointer disappears, and the magic remote control works as a common remote control.
- Use within an effective distance of 10 meters. Using the remote control from greater distances or when obstructions block the sight line may cause malfunctions.
- Electronic devices nearby may cause communication interference. Devices such as microwave ovens and wireless LANs use the same frequency range (2.4 GHz) as the Magic Remote Control and may cause interference.
- Take care not to bang it against other hard objects such as furniture or the floor.

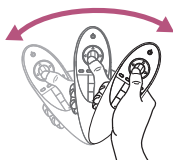
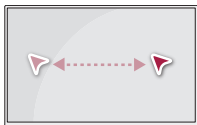

USING THE PROJECTOR

Connecting the Antenna or Cable

To watch TV using an indoor/outdoor antenna, connect a wall terminal and the antenna port of the Projector using an RF cable (75 Ω).

You can watch terrestrial or cable (analog, digital) TV. (The RF cable is sold separately.)

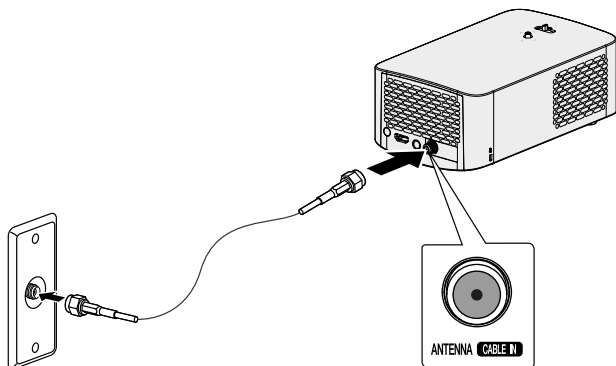

NOTE

- Make sure not to bend the copper wire of the RF cable (75 Ω). Turn the input jack to the right to fasten it.
- Ensure you use a standard coaxial cable (75 Ω , sold separately) when connecting to the projector input.
- For better image quality in locations where signal strength is low, purchase and install a signal amplifier (booster).
- A signal splitter is required if you want to use two or more projectors through one antenna.
- If you have any problems when installing the antenna, please consult a suitable retailer or the store where you purchased the antenna.

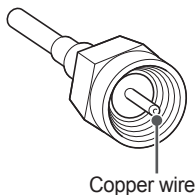

Watching Projector

Initial Setup

The menu screen display in this owner's manual is an example to help users understand how to operate the product and may look different from the actual screen.

- The illustration of the menu may differ from the actual screen on the product.
- 1 Connect the power cord correctly.
 - 2 After waiting for a moment, press the **POWER** button on the remote control or the joystick button.
 - 3 When you turn on the projector for the first time, a setting screen appears as shown below. Here, you can specify the items required for watching the projector more easily.

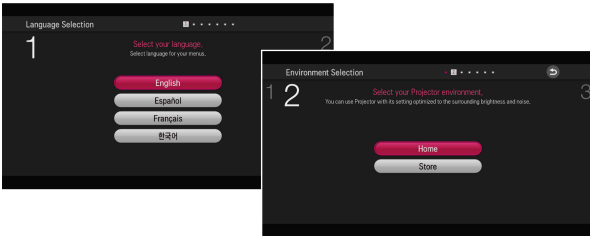
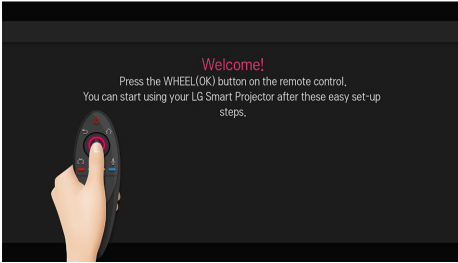

- **Store** mode is used when displaying the product in-store. The picture mode is automatically reset after a certain period of time. You can select **Home** to use the product at home.

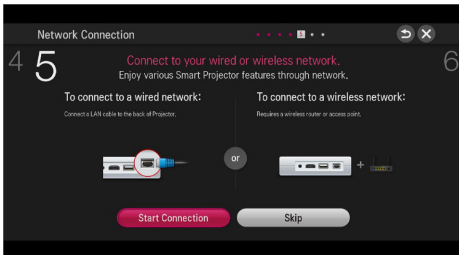
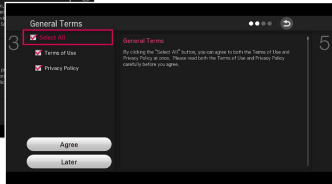
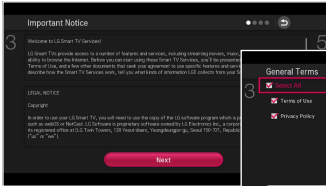
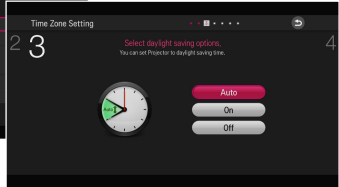
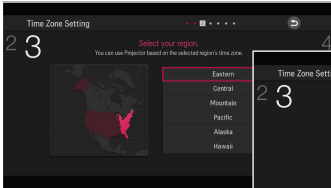

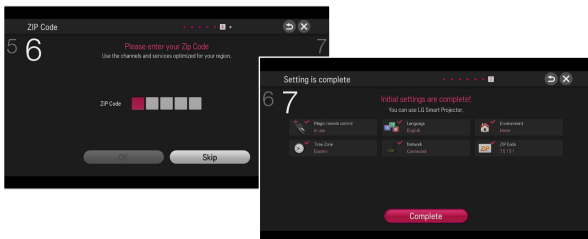

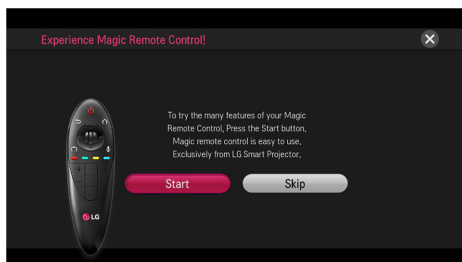

- The initial settings are completed when you select the settings above.
- **ZIP Code** : This feature is available in certain countries only.



NOTE

- For **Auto Tuning** while using the projector, go to  (**Home**) → **SETTINGS** → **CHANNEL** and select **Auto Tuning**.
- To change the mode while using the projector, go to  (**Home**) → **SETTINGS** → **OPTION** and select **Mode Setting**.

Focus and Position of the Screen Image

When an image appears on the screen, check if it is in focus and fits the screen properly.

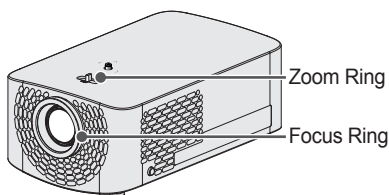



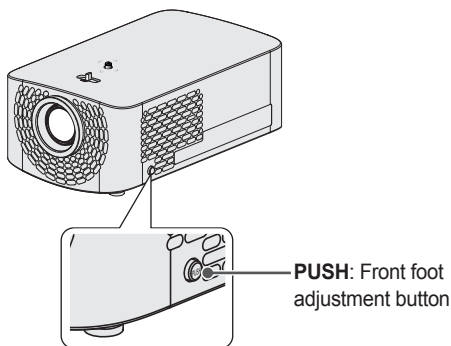

- To adjust the focus of the image, rotate the focus ring.
- To adjust the size of the image, rotate the zoom ring. To move the screen image upward/downward, adjust the height of the foot at the bottom of the projector.



- While pressing the **PUSH** button, adjust the projector upward/downward until the screen image is in the desired position.
- When you release the **PUSH** button, the front foot becomes fixed at the current position.

Watching With the Projector

- 1 When in standby mode, press the **POWER** button to turn the projector on.
- 2 Select the  (**Home**) → **INPUT LIST** and select the input signal you want.
- 3 Control the projector using the following buttons while watching projector.

Button	Description
 CH	Changes the TV channel.
 VOL	Adjusts the volume level.
 (MUTE)	Mutes the sound from the projector.

- 4 To turn the projector off, press the **POWER** button.

To Set Channel

Image shown may differ from your projector.

To View Program Information

Displays information on current program and / or current time, etc.

- 1 Move the pointer of the Magic Remote control to the top of the projector screen.
- 2 Click the activated channel banner area.
- 3 The program details will be displayed at the bottom of the projector screen.

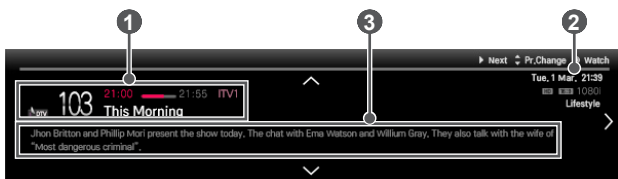

	Description
1	Program name
2	Current time
3	Detail information on program (for digital broadcast)

To Set Favorite Channels

🏠 (Home) → **SETTINGS** → **CHANNEL** → **Channel Edit**

- 1 Move to the desired channel on **Wheel (OK)** button. Channel is selected.
- 2 Press **Set as Favorite**.
- 3 Select the desired Favorite channel group.
- 4 Select **OK**. Favorite is set.

To Use Favorite

 (Home) → MY APPS → Ch. List

Channel list will appear. Select the desired preset favorite channel from Favorite List A to D.

To Set Auto Tuning

 (Home) → SETTINGS → CHANNEL → Auto Tuning

Automatically tunes the channels.

- Channels are not registered properly unless the antenna / cable is connected correctly.
- **Auto Tuning** only sets channels that are currently broadcasting.
- If **Lock System** is turned on, a pop-up window will appear asking for password.

To Set Channels Manually

 (Home) → SETTINGS → CHANNEL → Manual Tuning

Adjusts channels manually and saves the results.

For digital broadcasting, signal strength, etc. can be checked.

To Edit Channels

 (Home) → SETTINGS → CHANNEL → Channel Edit

Edits the saved channels

Set your selected channel as favorite, block / unblock, and Add / Delete.

Additional Options

To adjust Aspect Ratio

Select  (Home) → **SETTINGS** → **PICTURE** → **Aspect Ratio**

Selects the screen aspect ratio.

Menu	Description
16:9	Resizes images to fit the screen width.
Just Scan	Displays video images in the original size without removing parts of the edge of the image. <ul style="list-style-type: none"> In DTV / HDMI / Component (over 720p) mode, Just Scan is available.
Set By Program	Depending on the input signal, screen aspect ratio changes to 4:3 or 16:9.
4:3	Resizes images to the previous standard 4:3.
Zoom	Resizes the image to fit the screen width. The top and bottom parts of the image may be cut off.
Cinema Zoom 1	Formats an image to the cinema scope ratio (2.35:1) and zooms in on the ratio.



NOTE



- While viewing an external device, these cases may result in image burn :
 - a video with stationary caption (such as network name)
 - 4:3 aspect ratio mode for an extended period.
 Take caution when using these functions.
- Available picture size may differ depending on the input signal.
- The screen aspect ratios on HDMI-PC input are available in 4:3 and 16:9 only.

Using the Edge Adj (4 Corner Keystone) Function

Edge Adj (4 Corner Keystone) adjusts the horizontal and vertical sides of the projected image if the projector is at an angle and not perpendicular to the screen. This feature ensures the shape of the projected image is not distorted.

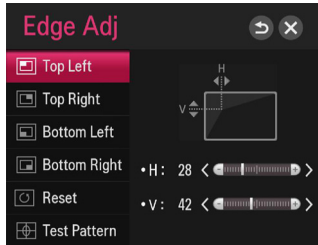
Use this feature only when the projector cannot be set up at the optimal angle. **Edge Adj** may result in a loss of image quality.



- 1 Go to  (Home) → **SETTINGS** → **OPTION** → **Edge Adj**.
- 2 The value range of **Edge Adj** is as follows.
 - Top Left (H: 0 to 100, V: 0 to 100)
 - Top Right (H: -100 to 0, V: 0 to 100)
 - Bottom Left (H: 0 to 100, V: -100 to 0)
 - Bottom Right (H: -100 to 0, V: -100 to 0)
- 3 Press the  **Wheel (OK)** button.





NOTE

- When using **Auto Keystone(Vertical)**, the current value set for **Edge Adj** is changed to the value that has been set with **Auto Keystone(Vertical)**.

Changing Input Device

To select an external input

Selects external input.

- Select  (**Home**) → **INPUT LIST** or press the **INPUT** button on the remote control to display the input selection screen.
 - Connected inputs are displayed first. However, **AV** is always activated.
- Select an input signal using the remote control's **INPUT** button to connect the projector to the desired input. You can use the  or  button to switch among all the input modes.

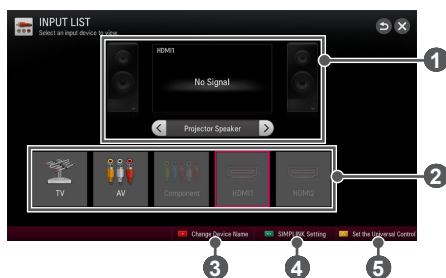







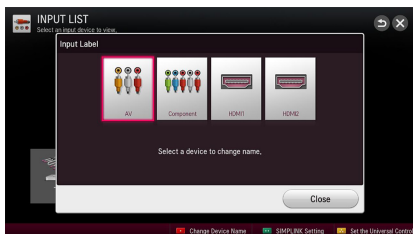

	Description
1	Selects speaker.
2	Selects input.
3	Edits the name of external device connected to external terminal.
4	Sets SIMPLINK .
5	Sets Universal Remote Control . <ul style="list-style-type: none"> • This feature is available in certain countries only.

Selecting an Input Label



Displays which devices are connected to which input ports.



- 1 Select  (**Home**) → **INPUT LIST** or press the **INPUT** button on the remote control to display the input selection screen.
- 2 Press the **red** button.
- 3 Press the  or  button to go to the desired input and press the  **Wheel (OK)** button.
- 4 Press the , , , or  button to select a device name.

To Use SIMPLINK

SIMPLINK is a feature that enables you to control and manage various multimedia devices conveniently using the projector remote control only via the SIMPLINK menu.

- 1 Connect the projector's **HDMI** terminal with the SIMPLINK device's HDMI output terminal using an HDMI cable. For home theater units with a SIMPLINK function, connect **HDMI** terminals as above, and use an optical cable to connect **Optical Digital Audio Out** from the projector to **Optical Digital Audio In** of the SIMPLINK device
- 2 Select  (**Home**) → **MY APPS** → **SIMPLINK**. SIMPLINK menu window appears.
- 3 Select **SIMPLINK Setting** on SIMPLINK menu window. SIMPLINK setup window appears.
- 4 **SIMPLINK** to **On** in SIMPLINK setup window.
- 5 Close SIMPLINK setup window.
- 6 Select the device to control from  (**Home**) → **MY APPS** → **SIMPLINK**.



NOTE





- This function only works on devices with the SIMPLINK logo (SIMPLINK). Verify that the external device has a SIMPLINK logo.
- To use the SIMPLINK function, you need to use a high-speed HDMI® cable (with CEC, or Consumer Electronics Control, feature added). High-speed HDMI® cables have pin 13 connected for information exchange between devices.
- Turn on or select the media of a device with home theater features to see the speaker switch to **External Speaker**.
- To use the Listen via External Speaker function, connect an optical cable (Purchase separately) or HDMI-ARC-enabled device via the HDMI-ARC port.
- Switching to external input causes devices operating with SIMPLINK to stop.
- Use of a third-party device with HDMI-CEC features may cause malfunctions.
- Connect with an Optical cable (sold separately) to use External Speaker.

Explanation of SIMPLINK Features

Menu	Description
Direct Play	Plays the multimedia device on the projector instantly.
Select multimedia device	Selects the desired device via the SIMPLINK menu to control it from the projector screen instantly.
Disc playback	Manages the multimedia device with the projector remote control.
Power off all devices	If the Auto Power function is set to On in the SIMPLINK settings , turning the projector off will turn the power off on all SIMPLINK-connected devices.
Sync Power on	If the Auto Power function is set to On in the SIMPLINK settings , turning on a SIMPLINK device will turn the projector on.
Speaker	Selects speaker either on the home theater unit or the projector.

Using the Quick Menu

You can customize frequently used menus.

- 1 Select  (Home) → MY APPS → Quick Menu.
- 2 Press the  or  button to select a menu and press  Wheel (OK) button.

Menu	Description	
Aspect Ratio	Resizes the picture.	
Picture Mode	Changes the picture mode.	
Sound Mode	Sets the sound mode.	
Sleep Timer	Sets the projector to be turned off at the specified time.	
Caption	Sets whether to display captions.	
Multi Audio	Sets MONO or STEREO , or a language for a bilingual broadcast (digital signal).	
SAP	Changes the MTS sound (analog signal).	
Energy Saving	Reduces power consumption by adjusting peak screen brightness.	
AV Mode	Sets the genre.	
	Mode	
	Off	You can watch using the settings in the video/audio menu.
	Sport	Optimizes video/ audio settings for sports.
	Cinema	Change to optimal video/ audio settings for movies.
Game	Change to optimal video/audio settings for games.	
Del/Add	Can delete or add channels.	
USB Device	Allows you to remove a connected USB device in a safe manner.	

- 3 Press the , , , or  button to scroll through the following menus.

To Set Sound

To Set Sound Output

To use projector's speakers

Sound is output through the projector speaker.

-  (Home) → **SETTINGS** → **SOUND** → **Sound Out** → **Projector Speaker**

To use External Speaker

Sound is output through the speaker connected to the optical or HDMI (ARC) port.

SIMPLINK is supported.

-  (Home) → **SETTINGS** → **SOUND** → **Sound Out** → **External Speaker (Optical/HDMI ARC)**

To use Digital Sound Out

Sets up Digital Sound Output.

-  (Home) → **SETTINGS** → **SOUND** → **Sound Out** → **External Speaker (Optical/HDMI ARC)** → **Digital Sound Out**

Item	Sound Input	Digital Sound Output
Auto	MPEG	PCM
	Dolby Digital	Dolby Digital
	Dolby Digital Plus	Dolby Digital
	HE-AAC	Dolby Digital
PCM	All	PCM

To connect and use an LG audio device

LG audio device allows you to enjoy rich powerful sound easily.

-  (Home) → **SETTINGS** → **SOUND** → **Sound Out** → **LG Sound Sync (Optical)**

Connect an LG audio device with the  logo to the **OPTICAL DIGITAL AUDIO OUTPUT** port.

To Connect and Use a Bluetooth device

Sound output is through the Bluetooth device.

-  (Home) → **SETTINGS** → **SOUND** → **Sound Out** → **Bluetooth**
- The devices that can be connected are: LG BTS1, LG HBS-700, LG HBS-730, LG HBS-800 (Product availability may vary by country.)
- For wireless connection, if the device fails to connect. Check the device power to connect and if the LG Audio device is in a proper operating condition.
- If two or more devices are detected, the first detected device is connected first. To view more detected devices to connect, press the **Show More** button.
- Products from other manufacturers may not be compatible.

To Connect and Use a Headphone

Sound output is through the headphone.

-  (Home) → **SETTINGS** → **SOUND** → **Sound Out** → **Headphone**
- If you connect headphones while the projector is powered on, it automatically detects the headphones and sounds through them.

Using the Multi Audio

Multi Audio means stereo and multiple language broadcast from the channel provider.

-  (Home) → **MY APPS** → **Quick Menu** → **Multi Audio**

In the case of digital broadcast

Multiple languages can be selected depending on the multi-language signals from the TV station.

- For default language, select at  (Home) → **SETTINGS** → **OPTION** → **Language** → **Audio Language**.

In the case of analog broadcast

Item	Description
Mono	Left and right speakers produce sound, and the sound mode is mono. Select this menu to listen in Mono mode regardless of broadcast state. This can be set for a stereo broadcast signal. Select Mono in poor reception areas (e.g., areas with weak or erratic signals) or when multi audio reception is not clear.
Stereo	The sound mode is in stereo when the sound comes out of both left and right speakers.
Main language / Sub language	If the station broadcasts a multi-language signal, different languages may be selected.

ENTERTAINMENT

To use Smart Features

To use Home Screen

- Press the  (Home) button on the remote control.

With all projector features on one screen, everyone can access a wealth of content and applications conveniently via the quick and easy-to-use menu, arranged by themes such as Live TV, MY APPS, etc.

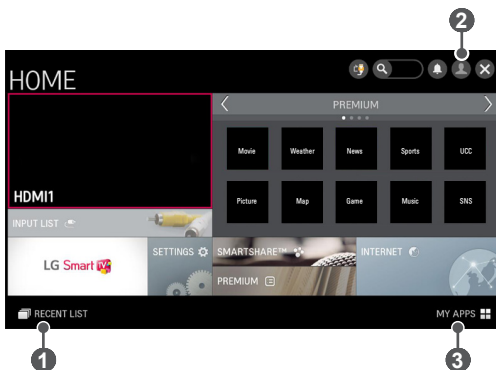



	Description
①	RECENT LIST
②	Sign in
③	MY APPS

To use MY APPS

-  (Home) → MY APPS
- Select **MY APPS** at the lower right of the home screen.
- Check pre-installed apps and apps you have downloaded.

To edit items in MY APPS

- Select  (Home) → **MY APPS** →  (Edit).
- On the **MY APPS** page, select  (Edit) at the top of the screen to move or delete apps. Please note that system apps can be moved, but cannot be deleted.
- Changes orders / deletes items by dragging the app icons if your device has a Magic Remote Control.

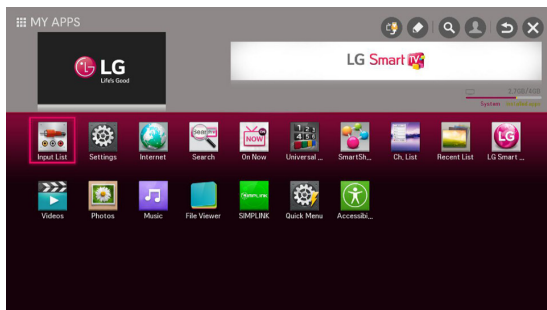

- The illustration of the menu may differ from the actual screen on the product. (Depending on country)

To Connect Network

A wireless or wired network connection is required to use smart features.

When connected to the network, you can use premium content, LG Smart World, DLNA and more.

One-click Network Connection

Connects easily to a wired/wireless network.

-  (Home) → **SETTINGS** → **NETWORK** → **Network Connection** to connect to an available network automatically. Follow the prompts on the projector.

To Connect to a Network Through Set Expert

For use in special circumstances such as in offices (in cases where a static IP is used).

- Select  (Home) → **SETTINGS** → **NETWORK** → **Network Connection** → **Start Connection** (→ **Other Network List**) → **Manual Setup**.

1 Select a **Network Connection**, either **Wired** or **Wireless**.

2 When connecting via Wi-Fi, use the one of the following network connection methods.

Item	Description
AP List	Connects to the network selected from the AP List.
Enter the SSID	Connects to the wireless AP typed in.
WPS-PBC	Connects easily when the button of a wireless AP supporting PBC is pressed.
WPS-PIN	Connects easily when the PIN of the wireless AP that you wish to connect to is entered in to the AP website.

To Use the Wi-Fi Direct Function

Wi-Fi Direct is a function that allows your projector to connect with a Wi-Fi Direct device without Internet connection. With SmartShare™, you can watch the files stored on a device connected via Wi-Fi Direct.

- Select  (**Home**) → **SETTINGS** → **NETWORK** → **Wi-Fi Direct**.
- 1** Set **Wi-Fi Direct** to **On**. (If you do not use it, please change it to **Off**.)
 - 2** Enable the Wi-Fi Direct settings on the device to which you want to connect.
 - 3** A list of devices that can be connected to the projector is displayed.
 - 4** Select a device to connect.
 - 5** Select **Yes** when the connection request message appears.
 - 6** If the device that you want to connect accepts the request, **Wi-Fi Direct** is connected.

Tips for Network Settings

- Use a standard LAN cable (Cat5 or higher with RJ45 connector, 10 Base-T or 100 Base TX LAN port).
- Resetting your modem can cause network connection problems. To resolve the problem, turn the power off, disconnect and reconnect, and then turn the power back on.
- LG Electronics is not responsible for any network connection problems or any faults, malfunctions and errors caused by an network connection.
- A network connection may not work properly depending on the Internet service provider.
- A DSL modem is required for a DSL service; a cable modem is required for a cable service. Only a limited number of network connections may be available, and projector network setting may not be available depending on your contract with your Internet Service Provider (ISP.) (If only one device is allowed per line and the PC is already connected, other devices cannot be used.)
- Wireless networks can be subject to interference from other devices operating at a frequency of 2.4 GHz (wireless phones, Bluetooth devices, or microwave ovens). There may also be interference from devices with a frequency of 5 GHz, same as other Wi-Fi devices.
- The surrounding wireless environment can cause the wireless network service to run slowly.
- If you do not turn off the entire local home network, network traffic may occur on some devices.
- For an AP connection, an access point device that supports wireless connection is required and the wireless connection feature must be enabled on the device. Contact your service provider regarding availability of wireless connection on your access point.
- Check the SSID and security settings of the AP for AP connection. Refer to the appropriate documentation for SSID and security settings of the AP.
- Invalid settings on network devices (wired/wireless line sharer, hub) can cause the projector to run slowly or not operate properly. Install the devices correctly according to the appropriate manual and set the network.
- Connection method may differ according to the AP manufacturer.

SMARTSHARE

Smartshare is the name of contents sharing and usage function that includes USB Connection, SCREEN SHARE (Miracast™, Intel's WiDi), DLNA and others.



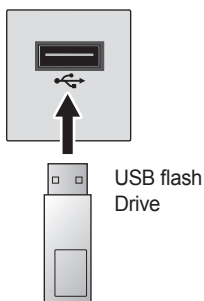

Before Using

Connecting a USB Device

Connect a USB device (external HDD, USB memory) to the USB port of projector to enjoy the content files stored in the USB device with your projector. You cannot write or delete data in the USB device. Connect a USB flash drive as shown below.



Removing a USB Device

- 1 Select  (Home) → MY APPS → Quick Menu.
- 2 Use the  or  button to move to **USB Device** and press the  **Wheel (OK)** button.
- 3 Select a USB to remove. Wait for confirmation that the USB device has stopped before removing the USB.



NOTE

- If detached early, an error may occur on the projector or the USB storage device.
- Once a USB device has been selected for removal, it can no longer be read. Remove the USB storage device and then re-connect it.

Tips for using a USB device

- If the USB storage device has a built-in auto recognition program or uses its own driver, it may not work.
- Some USB storage devices may not work or may work incorrectly.
- If you use a USB extension cable, the USB device may not be recognized or may not work properly.
- Use only USB storage devices formatted with the Windows FAT32 or NTFS file system.
- For external USB HDDs, it is recommended that you use devices with a rated voltage of less than 5 V and a rated current of less than 500 mA.
- It is recommended to use a USB hub or hard disk drive with power supplied. (If the power supplied is not enough, the USB storage device may not be detected properly.)
- It is recommended that you use USB flash drives of 32 GB or less and USB HDDs of 2 TB or less.
- If a USB HDD with power-saving function does not work properly, turn the power off and on. For more information, refer to the user manual of the USB HDD.
- Data in USB storage device can be damaged so be sure to back up important files to other devices. Data maintenance is the user's responsibility and the manufacturer is not responsible for data loss.

To use SmartShare™

1 Press the  (**Home**) button on the magic remote control.

2 Select **SMARTSHARE™**.

You can watch the photo, music, video, and document on the projector by connecting a USB or home network (DLNA). The photo, music, video, and document files of all devices connected to the projector are displayed. (For the document files, only those in the devices connected via USB are displayed.)

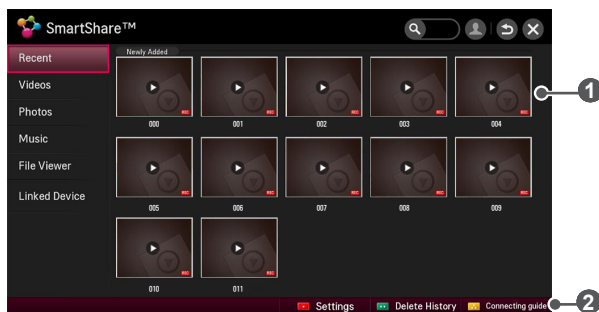

	Description
1	Displays photo/music/video files on all devices connected to the Projector.
2	Shows how to connect PC, smartphone/device, and USB.

Watching the Videos

In the **Videos**, you can watch movies stored on the connected USB device.

Controls playback and sets options while viewing videos.

Playing video - warning

- Some subtitles created by users may not work properly.
- The video and subtitle files should be placed in the same folder. For subtitles to display correctly, the video and subtitle files must have the same name.
- Subtitles on an NAS (Network Attached Storage) device may not be supported depending on the manufacturer and model.
- We do not support any stream that contains GMC (Global Motion Compensation) or Qpel (Quarterpel Motion Estimation).
- Only H.264 / AVC profile level 4.1 and lower is supported.
- The file size limit is dependent on the encoding environment.
- It works only the above version of Window Media Audio V2.
- It's not supported AAC Main Profile.
- Video files created by some encoders may not be played back.
- Video files in formats other than the ones specified here may not be played back.
- Playback of video files stored on the USB device that do not support High Speed may not work properly.
- The projector supports DTS audio codec when the USB / HDMI video file playback.

To control video playback

You can control playback using the following buttons.



Shows the current playing position.

Use the ◀ or ▶ button to move forward or backward.

Item	Description
▶	Resumes normal playback.
	Pauses the video player.
▶▶	Displays in slow motion.
◀◀▶▶	Whenever this button is pressed, the playback speed is increased or decreased by one unit.
◀◀▶▶	Plays the previous/next file.
Option	Sets the option.

Viewing the Photos

You can view photos stored on a connected device.

To control photo view

You can control playback using the following buttons.

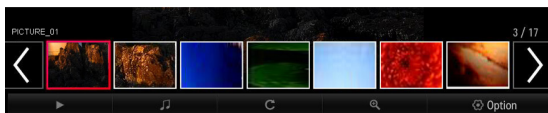

Item	Description
< , >	Selects the previous or next photo.
▶	If no picture is selected, all photos in the current folder are displayed in a slide show. If some photos are selected, those photos are displayed in a slide show. <ul style="list-style-type: none"> • Set Slide Show Speed in the Option → Set Photo View. menu.
♪	You can listen to music while viewing full-size photos. <ul style="list-style-type: none"> • Set BGM in the Option → Set Photo View. menu.
⌚	Rotates photos. <ul style="list-style-type: none"> • Rotates a photo 90°, 180°, 270°, 360° clockwise. • Photos cannot be rotated if their width is greater than the height of the maximum supported resolution.
🔍	Enlarges or reduces the photo. Use the Up/Down/Left/Right buttons to select a page and press the Wheel (OK) button.
Option	A setting popup window will appear.

Listening to Music

You can play audio files stored on the connected device.

To control music playback

You can control playback using the following buttons.



Changes the playing position.

Item	Description
	Plays the previous/next file.
	Pauses the music player.
	Resumes normal playback.
	Sets the repeat playback.
	Sets the random playback.
	Plays music with the projector screen turned off.
	Sets Option for the music list.

- If you use the USB device, time information will be not shown on screen.

Viewing Files

You can see document files stored on a connected device.

Supported File Formats

XLS, XLSX, DOC, DOCX, PPT, PPTX, TXT, PDF, HWP

Microsoft Office 97/2000/2002/2003/2007 version

Adobe PDF 1.0/1.1/1.2/1.3/1.4 version

Hangul 2007 version

- File Viewer realigns a document, so it may look different from what is displayed on a PC.
- For documents that include images, the resolution may look lower during the realigning process.
- If the document is large or has many pages, it may take longer to load.
- Unsupported fonts may be replaced by other fonts.
- The file viewer may not open for Office documents that contain many high resolution images. In that case, reduce the image file size, save it on a USB storage device and run the file viewer again or connect your PC to the projector and open the file on your PC.

Browsing File Viewer

You can control playback using the following buttons.

- Press the **^ v CH** button to move to the previous or next page.
- Press the **+ = VOL** button to zoom in or zoom out.
 - Press the **Wheel (OK)** button.
 - Press the **Up/Down/Left/Right** buttons to move to **Go Page** or **Zoom**.



Item	Description
Go Page	Moves to the page you specify.
Zoom	Enlarges or reduces the document.
Option	Sets Option for File Viewer.
List	Returns to a list.

To Set SmartShare™ Related Functions

Select  (Home) → SMARTSHARE™ → Settings.

Changes settings related to SmartShare™ content playback.

Advanced Setting

Item	Description
My Projector Name	Changes the name that appears when searching for the projector from other devices.
Network Status	Checks the network connection.
Wi-Fi Direct	Allows use of wireless connection functions such as Wi-Fi Direct and WiDi.
Auto Play on Receive	Choosing whether to ask before playing the content that is shared by other devices.
DivX(R) VOD	<p>Registers or releases DivX. Checks DivX Registration Code for playing DivX-protected videos. Register at http://vod.divx.com. Uses Registration Code to rent or purchase movies at www.divx.com/vod.</p> <ul style="list-style-type: none"> • Rented / purchased DivX files cannot be played if the DivX Registration Code of a different device is used. Use only the DivX Registration Code granted to this device. • Converted files not conforming to the DivX Codec Standard may not play or may produce abnormal images and sound.

Delete History

- To delete contents history, press **Delete History** button. Use the contents at **Recent** menu.

SmartShare™ supporting file

- Maximum data transfer rate: 20 Mbps (Mega bit per second)
- External subtitle formats supported: *.smi, *.srt, *.sub (MicroDVD, SubViewer 1.0/2.0), *.ass, *.ssa, *.txt (TMPlayer), *.psb (PowerDivX), *.dcs(DLP Cinema)
- Internal subtitle formats supported: XSUB (supports internal subtitles generated from DivX6)

Video Supported Codec

Maximum resolution: 1920 x 1080 @ 30p

Extension	Codec	
.asf .wmv	Video	VC-1 Advanced Profile, VC-1 Simple and Main Profile
	Audio	WMA Standard, WMA 9 Professional
.divx .avi	Video	DivX3.11, DivX4, DivX5, DivX6, XviD, H.264/AVC, Motion Jpeg, MPEG-4 Part 2
	Audio	MPEG-1 Layer I, II, MPEG-1 Layer III (MP3), Dolby Digital, Dolby Digital Plus, LPCM, ADPCM, DTS
.mp4 .m4v .mov	Video	H.264/AVC, MPEG-4 Part 2
	Audio	AAC , MPEG-1 Layer III (MP3)
.3gp .3g2	Video	H.264/AVC, MPEG-4 Part 2
	Audio	AAC, AMR-NB, AMR-WB
.mkv	Video	H.264/AVC
	Audio	HE-AAC, Dolby Digital
.ts, .trp, .tp, .mts, .m2ts	Video	H.264/AVC, MPEG-2, VC-1
	Audio	MPEG-1 Layer I, II, MPEG-1 Layer III (MP3), Dolby Digital, Dolby Digital Plus, AAC
.vob	Video	MPEG-1, MPEG-2
	Audio	Dolby Digital, MPEG-1 Layer I, II, DVD-LPCM
.mpg .mpeg	Video	MPEG-1, MPEG-2
	Audio	MPEG-1 Layer I, II, MPEG-1 Layer III(MP3), AAC

Audio File

File type	Item	Info
mp3	Bit rate	32 Kbps to 320 Kbps
	Sample freq.	16 kHz to 48 kHz
	Support	MPEG1, MPEG2, Layer2, Layer3

Available photo file

File type	Item	Info
2D (jpeg, jpg, jpe)	JPEG	Minimum: 64 x 64 Maximum: – Normal Type: 15360 (W) x 8640 (H) – Progressive Type: 1920 (W) x 1440 (H)

To use SCREEN SHARE (Miracast™ / Intel's WiDi Function)

To Use the Miracast™ / Intel's WiDi Function

You can view the screen of a device with Miracast™ and Intel's WiDi technologies on your projector. Contact the device manufacturer to find out if the device supports this function.

- Select  (Home) → **SETTINGS** → **NETWORK** → **Miracast™ / Intel's WiDi**.

- 1** Set **Miracast™ / Intel's WiDi** to **On**. (If you do not use it, please change it to **Off**.)
 - 2** Enable the **Miracast™ / Intel's WiDi** settings on the device that you want to connect to.
 - 3** A list of devices that can be connected to the projector is displayed.
 - 4** Select a device to connect.
 - 5** Select **Yes**, when the connection request message appears.
 - 6** If the device that you want to connect accepts the request, **Miracast™ / Intel's WiDi** is connected.
- When **Wi-Fi Direct** is set to **Off**, if you set **Miracast™ / Intel's WiDi** to **On**, **Wi-Fi Direct** is automatically set to **On**.
 - When you set the **Miracast™ / Intel's WiDi** function to **Off**, **Wi-Fi Direct** returns to the previous setting.

**NOTE**

- It is recommended to connect a laptop using **Intel's WiDi** within close range.
- Though **Intel's WiDi** can be connected without a wireless router, it is recommended to connect the wireless router first for optimal performance.
- You may not connect your projector to a non-LG Electronics device even when it is detected.
- It is recommended you to connect a device to a 5 GHz router.
- The response rate may vary depending on the user's environment.
- For more information on the device you want to connect to, refer to its owner's manual.

To connect DLNA

DLNA stands for Digital Living Network Alliance, which allows you to enjoy video / music / photo files stored on a PC or server on your projector via home networking.

To connect a DLNA-authenticated Smartphone

The Projector and the smartphone should be on the same network.

- 1** Ensure that Wi-Fi is enabled on the smartphone.
- 2** Install / run the app to share content on the smartphone.
- 3** Run *Share my mobile phone Content*.
- 4** Select the kind of content (video / music / photo) you wish to play.
- 5** Select the video, music, or photo file to play on the projector.
- 6** Select **Add to Play List**.
- 7** Select projector name on the device from which you want to play content. (projector model name is on the label of the device.)
- 8** Play ► shows the selected file on projector.

To connect DLNA DMR (Digital Media Renderer)

If the PC's operating system is Windows 7 or Windows 8 or the DLNA-certified device (e.g., mobile phone) is connected via a network, you can play music / videos / photos on projector without installing a separate program.

- 1** Configure Projector and PC on the same network. Configure Windows 7 or Windows 8-installed PC on the network.
- 2** Right-click the music / video / photo file that you want to play and use the *Remote Playback* feature that comes with Windows 7 or Windows 8.
To play content from a device such as a mobile phone, refer to the user guide for the device.
- 3** Content will be played on one device only even if more than one projector or device is connected. Play speed can vary depending on network speed.

To connect a DLNA DMP (Digital Media Player)

With a PC having SmartShare™ PC software, music / video / photo files may be replayed on the projector via home networking.

- 1** Configure projector and PC on the same network. The projector and each device should be connected through a single access point to enable DLNA service.
 - 2** Install SmartShare™ PC software on the PC from the website. Before installation, close all running programs including firewall and anti-virus programs.
 - 3** The server should be running in order to watch the shared file on your projector.
- For the website information, go to  (Home) → **SETTINGS** → **SUPPORT** → **Product/Service Info.**
 - For how to use the SmartShare™ PC software, refer to the software help.

SmartShare™ PC SW Installing and Setting

Install the SmartShare™ PC SW (DLNA) program on your PC.

- 1** Download the setup file from the path below in order to use the DLNA function. <http://www.lg.com/us/support/smart-share>
- 2** Install the downloaded DLNA software.
- 3** You can run the program when installation is complete.



NOTE

- DLNA or Media Link service is only available if projector and other devices are connected via a single router.
- Program speed can be delayed depending on the system performance and the network environment.

In Case of a DLNA Malfunction

- If a DLNA feature does not work properly, check network settings.
- A 5-GHz access point is needed to view 1080p videos via DLNA. A 2.4-GHz access point may cause frequent buffering or other problems.
- DLNA may not work properly on a wireless network. It is recommended to use a wired connection.
- Multi audio and internal subtitles are not supported in DLNA mode.
- If more than one projector is connected to a single server in DLNA mode, the content may not play depending on server performance.
- Subtitles may not be supported depending on the DLNA device.
- The DLNA feature may not work properly in all network environments.
- The DLNA feature cannot be used with some access points that do not support multicasting. For more information, refer to access point manual or consult with the manufacturer.
- Supported file types may differ depending on the DLNA server environment, even for file types supported by the projector.
- Too many sub-folders and files included in one folder may cause a malfunction.
- Information about the file from DLNA server may not be displayed correctly.
- SmartShare™ PC Software is recommended when watching video subtitles from a DLNA server.
- To add a subtitle file later, turn off the shared folder and reset.
- DRM files located in SmartShare™ PC Software server are not played.

To Use a Premium Service

-  (Home) → **PREMIUM**
- This service gives you easy access to a wide variety of content, such as video, news, and UCC, at any time, as long as you are connected to the network. Premium content includes specialized country-specific services taking regional cultural sensitivities into account as well as global content.

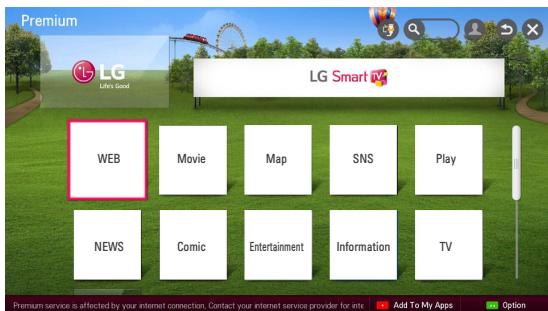

To Use Paid Content

Some Premium Content is provided as for-fee services. To purchase for-fee services, use either LG Electronics' proprietary billing system or that of each content provider.

If you are using the LG billing system, you can purchase paid content after signing up for LG Projector.

You can sign up for on the sign-up screen on your projector or the LG website (www.lgappstv.com). You can then sign into both the projector and the website with a single ID.

- 1 Click **Sign In** button in upper right corner of Home screen to sign in.
- 2 Move to the desired premium service. (For some premium services, separate sign-in is required after signing up for the premium service.)
- 3 After checking the content's pricing and service information, click the **Purchase** button. (There may be limitations on the available period and number of times depending on content.)
- 4 Once the purchasing process is completed, view the paid content by clicking the **Buy** button.
- 5 Select your ID on upper menu of Home screen and check history of purchases from **My Page** → **Payment inquiry**. It is also available on My Page → Purchase History of web site (www.lgappstv.com).

To Reset Premium

-  (Home) → **PREMIUM** → **Option** → **Initialization of Premium**
- Premium list, Premium information, country setting, and user sign-in information will be reset. When an error occurs during Premium update, a reset will fix the problem.



NOTE

- Content on offer by service providers are subject to change to enhance their service quality or deletion without any prior notice. Refer to the web site of each content provider for questions, troubleshooting, or latest information about Content. LG Electronics does not take any legal responsibility for content services and related information including discontinuation of service by the service provider.
- The quality of premium service may be affected by Internet connections. For any questions related to Internet speed or any other service problems, contact the Internet service provider.
- For best service quality, subscribe to an Internet service of 4.0 Mbps (1.5 Mbps or faster). Contact the ISP (Internet service provider) for any problems related to Internet speed.
- Content providers may make available content that is unsuitable for minors. Parental discretion is advised.

To Use LG Smart World

- Select  (Home) → MY APPS → LG Smart World.

LG Smart World is a projector application service available through Projector Service. You can download and enjoy many different apps (for fee or free) including education, entertainment, life, and news.



	Description
1	Sign in. When you sign in, ID is displayed. When you select the ID, you can select My Page and Sign Out .
2	Select the app to install.

To Sign Up With LG Smart World

-  (Home) → Sign In

Sign up is required to download and run apps.

- 1 Select **Sign Up** and agree to Legal Notice.
- 2 Enter ID and password.
- 3 In Confirm Password box, enter password again.
- 4 Select  **Wheel (OK)** button to complete sign-up process.



NOTE

- You can sign up for membership on either your projector or the website (www.lgapstv.com).
- After signing up for membership, log into your projector and our website with the same ID.
- You can sign in to up to five projectors with a single ID.
- The website (www.lgapstv.com) is not available in some countries.

To Install An App On Your Projector

-  (Home) → MY APPS → LG Smart World

Sign up is required to download and run apps.

- 1 Click the **Sign In** button at the top of the home screen to log in.
- 2 Select the **LG Smart World** card.
- 3 Select an app you want from the list.
- 4 Check the details of the app, then select the **Install** or **Buy** button.
- 5 Check that you have the functions or projector accessories required to install the app, then select the  **Wheel (OK)** button.
- 6 For paid apps, payment and purchase authentication is required.
- 7 Select **Run** once installation is complete to run the app immediately. If you do not want to run immediately, select **Close**. If you want to run the app later, select **My Apps** to check the list of apps installed on projector.

**NOTE**

- You can purchase apps via PC or Projector, but you must use the Projector to install and run them.
- If you have insufficient storage space on your Projector, you can download apps to a USB storage device connected through the Projector's terminal for USB apps. Apps stored on USB can be run / deleted / moved from the **My APPS** screen.
- A USB Flash Drive containing apps cannot be used for other data. (For USB Apps Only)

To Manage My Information

-  (Home) → **MY APPS** → **LG Smart World**

- 1** Sign in.
- 2** Select the currently signed-in ID at the top of the screen.
- 3** Select **My Page**.
- 4** Manages by examining Member Information, My Purchased Apps List, and Projector Installed Apps List.

Item	Description
My Information	Shows basic information about the ID currently signed in. To change your member information, visit www.lgapstv.com on your PC
Payment Inquiry	Shows Payment History of the signed-in ID.
Purchased Apps	Shows My Purchased Apps List for the signed-in ID. You can delete / re-install the purchased apps.

To Use Search Function

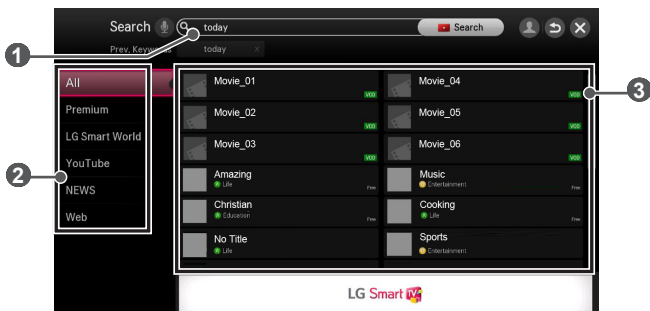

-  (Home) → MY APPS → Search
- You can search apps and contents using the Search function of LG Projector. When you enter keywords using the input device, such as the remote control, you can find apps of LG Smart World and some contents of the Premium service. Links are also provided to go for web search. If you are using SmartShare™, you can also search contents of SmartShare™. The Search categories and content types vary depending on the country and will be kept updating.





	Description
①	Enter search terms.
②	Category of search results
③	Search results

To Use the Voice Recognition Function



Using this Function Through Search

- 1** Go to  (**Home**) → **MY APPS** → **Search**. Select the voice recognition icon  on the left of the text field.
- 2** Speak slowly and clearly after the voice recognition window appears.
- 3** After the voice recognition is completed, the Similar List window pops up. If the popup window does not have the results you want, press **Retry** to try again. Select the most similar result, then it will be displayed in the text field. Press the Search button to get the result you want.

Using this Function on the Internet

- 1** Go to  (**Home**) → **INTERNET**. Move the Magic Remote Control pointer in the text field on a website to open the virtual keyboard.
- 2** Select the voice recognition icon  on the left of the text field on the virtual keyboard.
- 3** Speak slowly and clearly after the voice recognition window appears.
- 4** After the voice recognition is completed, the Similar List window pops up. If the pop-up window does not have the results you want, press **Retry** to try again. Select the most similar result, then it will be displayed on the text field. Press the Search button on the website to get the result you want.

**NOTE**

- The website (www.lgapstv.com) is not available in some countries.
- While the recognised result is in the text field, if you retry the voice recognition function, the previous result will be replaced with the new one.
- You can use Voice Search when you press the  on the Magic remote control even if QWERTY keyboard is shown on your screen.
- Check the network connection before using the voice recognition function.
- It is recommended to use the remote control no further than 10 cm from your face.
- The voice recognition may fail if you speak too fast or too slowly.
- The recognition rate may vary depending on the user's characteristics (voice, pronunciation, intonation, and speed) and the environment (noise and projector volume).
- To change the voice recognition language, go to  (Home) → **SETTINGS** → **OPTION** → **Language** → **Voice Recognition Language**.
- You can set Avatar to On / Off in  (Home) → **SETTINGS** → **OPTION** → **See Avatar**.

To Use Voice Mate Function

What Is Voice Mate?

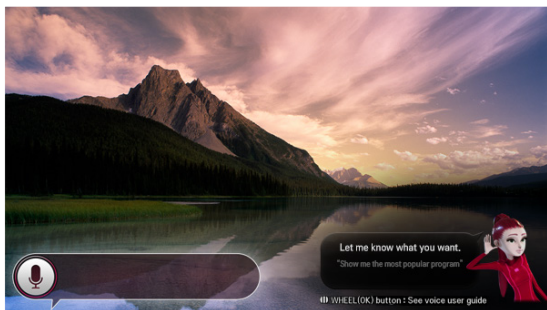

Voice Mate allows you to search desirable programs and content with your voice and adjust the projector.

- 1 Press the voice recognition  button on the magic remote control.
- 2 When the Voice Display bar is activated on the left of the screen, say what you want to watch.



- 3 Press the  **Wheel (OK)** button with the Voice Search standby to see the supported language in the voice guide.

How to Use Voice Mate?

- To use all the functions and services of Voice Mate, you need to set Smart Wizard and Time. Set up the network, region, auto tuning, and universal remote control through the Smart Wizard.
- In order to use Voice Mate, you must set up the network, time, region, and tuning.
- Set the language of your country to use Voice Mate.
- You can change the language for Voice Search in  (Home) → **SETTINGS** → **OPTION** → **Language** → **Voice Recognition Language**.
- You can turn the avatar **On/Off** in  (Home) → **SETTINGS** → **OPTION** → **See Avatar**.
- Point the universal remote control towards the set-top box when you use Voice Mate with it.
- When speaking a command, hold the remote within 10 cm of your face.
- The voice search may fail when you speak too fast or too slow.
- The recognition rate of Voice Mate may vary depending on the user's characteristics (voice, pronunciation, intonation, and speed) and the environment (noise and projector volume).
- If your voice is not recognized properly, Voice Mate may function in an unwanted manner.

What Are Other Functions of Voice Mate?

You can access various projector features using Voice Mate.

Item	Description
Channel	You can tune TV channels and search channel information.
Recommendation and Search	You can recommend and search TV programs and content files.
Information and Internet	You can also search other information such as today's weather.

- Available functions may vary depending on the country.
- For more supported examples, see the voice user guide.

See Avatar

Using the Avatar

-  (Home) → **SETTINGS** → **OPTION** → **See Avatar**

You can use the avatar when you use voice recognition. You can check the voice recognition status via the message from the avatar and it helps you to enter your speech correctly.

- If you set **See Avatar** to **On**, the avatar is activated on the bottom right of the screen.
- The voice recognition is still supported, even if **See Avatar** is set to **Off**.
- The speech balloon guide of **See Avatar** may vary depending on voice recognition features, languages, and models.

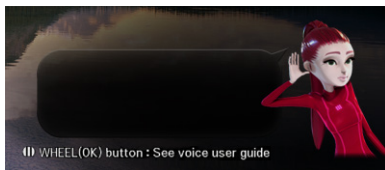

What Is On Now?

On Now allows you to select and watch recommended programs currently available on your projector. The Favorite function allows you to select and watch recommended content related to the program you are watching.

- This feature is available in certain countries only.

To Use On Now

To see in Mini view

- 1  (Home) → MY APPS → On Now

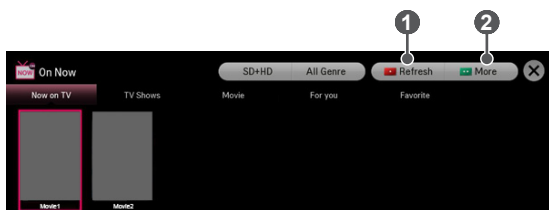

	Description
1	Refreshes all list items and moves to the beginning of the screen simultaneously.
2	Moves to Full View.

To See in Full View

-  (Home) → MY APPS → On Now → More

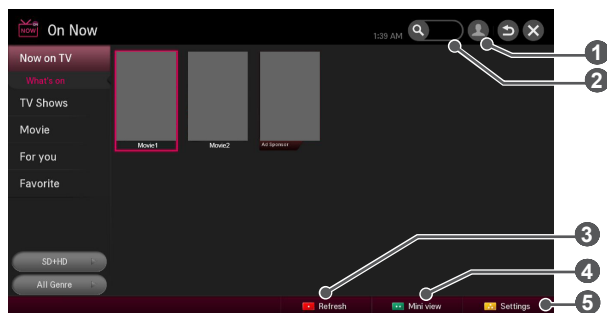

	Description
1	Sign in
2	Search
3	Refreshes all the list items and moves the screen up simultaneously.
4	Move to Mini view
5	Sets the options.

- For TV channels, you need to complete **Auto Tuning** to use this service properly.
- If you move to a different region, you need to set the region to your current location in order to use this service.
- The digital EPG (Electronic Program Guide) information which the TV receives may be different from the programs on the On Now TV list which uses an external EPG (Electronic Program Guide).
- You can control a connected set-top box tuner with the Magic Remote Control.
- An internet connection is required to use **On Now**.
- The channels in the On Now TV list are provided from the Service Operator. If the Service Operator changes them without notice, the actual TV channels may differ.
- The channel names of Service Operator on the On Now TV list are provided from an external EPG (Electronic Program Guide), so each name refers a Service Operator but may not match.
- The program thumbnail image on the On Now TV list is the representative image of the program, and it may be different from the image of the actual TV program schedule.
- If the channel information on the On Now TV list is different from the actual TV channel, set the channel menu in the **On Now Settings**.
- The On Now function recommends content based on real-time ratings, and certain content with low ratings may not be displayed.
- A scrambled channel may be displayed occasionally, depending on the TV signal type.
- The On Now function may not work with some set-top box models.
- If you experience problems with settings or operation, please tell us the name of your set-top box model on our website (http://www.lgappstv.com/ur_support) so that we can take action to provide appropriate support.

To Use Internet

-  (Home) → INTERNET
- Types URL manually on projector or visits websites added to favorite.



	Description
1	Types in the web address.
2	Chooses when you open several web browsers.
3	Add the current page to favorites.

- Internet supports up to Flash 11 but does not support platform-dependent technology like ActiveX.
- Internet only works with a pre-installed plug-in.
- Internet may not play any media file format other than the following: JPEG / PNG / GIF
- Internet will be forcibly closed when there is insufficient memory.
- For the Internet, fonts installed on the projector are used and may not be displayed normally depending upon the content played.
- Internet does not support file and font download.
- Internet is made for projector so it may function differently than browsers made for PC.
- Internet is a projector browser and may not work properly when playing some content files.



Frequently Asked Questions for Projector

Sign up is required to use LG Smart World.

You can sign up on either your projector or the LG website (www.lgappstv.com). Free apps are available immediately after signing up.

You can purchase paid apps using your credit card registered with the website or credits. Paid apps can also be purchased through carrier billing.

Problem	Solution
<p>When entering menu, the Initializing message always appears.</p>	<ul style="list-style-type: none"> The Initializing message shows you how long it takes to reboot the microprocessor and hardware, set up network communications, and communications with SDP (device authentication and basic information download). It takes about 20 seconds and this is a normal process.
<p>There is no content shown on the Premium card.</p>	<ul style="list-style-type: none"> Content may not be shown after changing the country setting on projector. Change to desired country in  (Home) → SETTINGS → OPTION → Service Country Setting
<p>While using internet features, there is a blank space on some Web pages.</p>	<ul style="list-style-type: none"> The internet of the Projector supports up to Flash 11 and may not replay any file format other than the following: JPEG, PNG, GIF
<p>Internet closes automatically when visiting website.</p>	<ul style="list-style-type: none"> If memory is insufficient because of large volume of image information in the web page, the browser may be forced to close.
<p>I already signed up on projector. Do I need to sign up again at web site (www.lgappstv.com)?</p>	<ul style="list-style-type: none"> If you sign up on your projector, no additional sign-up on the LG website (www.lgappstv.com) is required. After signing up on the projector, you can sign into the website by using the same ID and password and entering the additional information to complete the email verification process.

Problem	Solution
<p>Can each family member use a different ID with a single projector?</p>	<ul style="list-style-type: none"> • It is possible to register and use more than one ID on one projector. • To check the ID registered with Projector from  (Home) → Sign In → ID List. • You can check the list of apps purchased by each ID. However, you can see all apps installed by each ID in  (Home) → Sign In → My Page.
<p>What should I do if I forget my ID?</p>	<ul style="list-style-type: none"> • After signing up on a PC, use the Forgot ID? feature on web site (www.lgappstv.com) when needed. • After signing up on projector, check it from  (Home) → Sign In → Find ID.
<p>I purchased an app from the LG web site (www.lgappstv.com). How can I use it on the projector?</p>	<ul style="list-style-type: none"> • To check purchased apps from the projector, sign in and open the Purchased Apps menu. • Select the ID at the top of Home and check the app in My Page → Purchased apps.
<p>Can I see history of my purchased apps?</p>	<ul style="list-style-type: none"> • Select the ID at the top of Home and check the app in My Page → Purchased apps. • Sign in to website (www.lgappstv.com) and then select My Page → Purchase History.
<p>I deleted a paid app. Do I have to purchase again to download it?</p>	<ul style="list-style-type: none"> • If a purchased app is accidentally deleted, you can download and reinstall it without having to buy it again, as long as it is still in service. • Select the ID at the top of Home and re-download apps in My Page → Purchased apps. (Previously owned apps may not be re-downloaded or run, depending upon the software version.)

Problem	Solution
<p>Can I use apps from LG Projector's LG Smart World on both a projector and a PC?</p>	<ul style="list-style-type: none"> • Please check if the projector model supports LG Smart World. • The apps provided from LG Projector's LG Smart World can be used only on an LG Projector. • Apps may be purchased from the website (www.lgappstv.com) but cannot be used on a PC or Mac. Use care when purchasing.
<p>How can I check the ID currently signed in on the projector?</p>	<ul style="list-style-type: none"> • Select the ID at the top of Home and check the currently signed-in ID in My Page → My Information.
<p>I installed an app on the projector. Where can I check the installed app?</p>	<ul style="list-style-type: none"> • Select  (Home) → MY APPS. All paid and free apps installed on Projector are displayed.
<p>There is a difference between the app size shown on the screen and the actual app size installed on projector.</p>	<ul style="list-style-type: none"> • The app size shown in the screen includes the additional space needed for installing apps so it may be different from actually installed app size.
<p>I forgot my password on the projector. What should I do?</p>	<ul style="list-style-type: none"> • If you only provide the ID and password when signing up on your projector, you cannot recover your password when it is lost. Create a new ID and sign up with the ID. • If you provide other information than the ID and password when signing up on your projector or the LG website (www.lgappstv.com), you can recover your password on the website.

Problem	Solution
<p>Do I need to store payment information in web site to purchase paid apps?</p>	<ul style="list-style-type: none"> • The following payment methods are available to purchase paid apps on your projector: credit card, credits, and carrier billing. • To purchase paid apps using your credit card or credits, you should have a credit card registered with the LG website (www.lgappstv.com) or have enough credits. Paid apps can also be purchased through carrier billing if your credit card details are not registered with the website or you do have enough credits. If you purchase paid apps on the website, the following payment methods are available: credit card or credits.
<p>Can I cancel an app that I have purchased?</p>	<ul style="list-style-type: none"> • As a member, you cannot demand refund just because you changed your mind after purchase. • If there is a defect in the product or a problem of using the product, which is not your fault, you can ask for a refund. However, the valid reason for refund must be provided.
<p>Should I use only an email address for my ID?</p>	<ul style="list-style-type: none"> • For new sign-up members, the ID format has changed from a combination of alphanumerics to your email address. • You can only use an email address for your ID when signing up.
<p>Do I need to change my ID format to the email address?</p>	<ul style="list-style-type: none"> • For new sign-up members, the ID format has changed from a combination of numbers and alphabets to the email address. • If you are already a member, you can still use your existing ID or change it to the email address.

Problem	Solution
What is the LG account?	<ul style="list-style-type: none">• The LG account allows you to sign into all of the LG Smart service with a single ID and password. You can use the following services with your LG account: LG Projector, LG Smart World (excluding some countries), LG Smart ThinQ, and LG Smart air conditioning, etc. Additional information may be required depending on the service.

USING ADVANCED FUNCTIONS

To Use Screen Remote

- This feature is available in certain countries only.

To Use Screen Remote

Press the **123** button on the magic remote control.

Select a button on the screen remote displayed on the screen using the magic remote control.

- The type of buttons on the screen remote varies depending on the region or the type of a connected device.
- Image shown may differ from your projector.

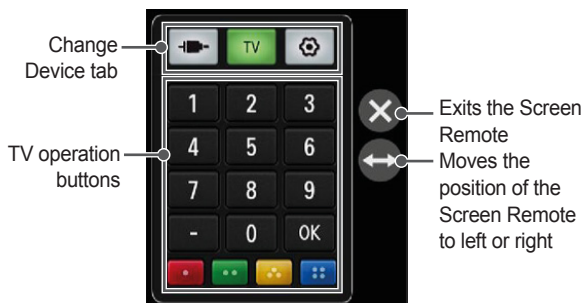



To Control a Device Connected to the Projector Using the Screen Remote

You can control a device connected via SIMPLINK or MHL using the Screen Remote.



- 1 Check if the device is connected to the Projector.
- 2 After pressing the **123** button on the magic remote control, select the device you want to control in the Change Device tab. The screen remote that can control the device appears.
 - This may not work with some buttons.

To Use the Universal Control function

With the Magic Remote control, you can control a set-top box, Blu-ray player, home theater system, etc.

- This feature is available in certain countries only.
- 1 Check if a device you want to set is connected to your projector.
 - 2 After pressing the **123** button on the Magic Remote control, select the icon of a device you want in the change device tab.
If there is no device you want, press the  on the tab, and select the external device you want. Once the setup is complete, the name of the selected device is displayed in the Change Device tab.
 - 3 When you select a device you want in the Change Device tab, the Screen Remote that can control the device appears on the screen.
To see more control buttons, select  at the bottom of the Screen Remote.

To change or clear the Universal Control settings

- 1 After pressing the **123** button on the magic remote control, select the  (TV/input selection) button.
- 2 Select **Change Setting** or **Cancel Setting** at the bottom of the device to be changed.
 - When change setting, check if the power of the device to be changed is turned on.
 - You can set one device per type.
 - With the screen remote, you can only control the devices of a brand or manufacturer that you can select in the setup screen.
 - If you connect to a network before setting the universal remote control, update for the latest manufacturer list is available.
 - Some buttons may not work depending on the external device model.
 - Place the device near the projector for seamless operation.
 - If the device is in a drawer, open the drawer.
 - Go to  (Home) → **MY APPS** → **Universal Control** or  (Home) → **INPUT LIST** → **Set the Universal Control** and add, delete, or change a device.
 - Please be advised that the channel tuning feature may not work properly if you have already manually assigned channel numbers that differ from the original set-top box channel numbers.

To Control a Projector Using a Smartphone

You can download the LG TV Remote app from Google Play Store or Apple App Store and use it on any projector connected with your smartphone.

- Now you can enjoy your favorite projector shows on your smartphone. (Some models only.)
- You can easily enter your account information to log in.
- You can add your favorite channels on your smartphone.
- You can use the functions such as **PREMIUM**, **MY APPS**, and **SMARTSHARE™** directly on your smartphone.
- The text input function is supported, so you can enter text easily. (Text cannot be entered on some screens.)
- Select the app's touch pad to control in the same way the pointer of the magic remote control works.
- Keypad which allows you to control the set-top box and media devices is provided. (Some models with specified conditions only.)
- You can set the projector to the power-saving mode while watching projector on your smartphone.

To Use a USB Input Device On a Projector

To Use a USB Wired/wireless Mouse

Connect your mouse to the USB port. Use the mouse to move the pointer on the Projector screen and select the menu you want.

Mouse	Magic Remote Control
Left Button	OK Button on Magic Remote Control
Wheel Button	Wheel Button on Magic Remote Control

- The right mouse button and any special buttons will not work with the Projector.
- The usability of a wireless USB mouse and keyboard may be affected by the radio frequency environment and the distance.





To Use a USB Wired/wireless Keyboard

Connect your keyboard to the USB port. You can enter text with the keyboard when using the search function and the Internet.

- Text cannot be entered on some screens.
- It is recommended to use a product which is tested for compatibility with the LG Projector.
LOGITECH K200, LOGITECH K400, MICROSOFT Comfort Curve 2000, MICROSOFT MS800, and LG Electronics ST-800
- You can change the input language by pressing the language switch key (or the right Alt key) on your keyboard.





CUSTOMIZING SETTINGS

SETTINGS

- 1 Press the  (**Home**) button and select **SETTINGS**.
- 2 Use the \triangle or ∇ button to select the desired item and press the  **Wheel (OK)** button.
- 3 Use the \triangle , ∇ , \triangleleft , or \triangleright button to set up the desired item and press the  **Wheel (OK)** button.
- 4 Press the  button when completed.

Menu	Description
PICTURE	Adjusts the image quality for optimal viewing.
SOUND	Adjusts the sound quality and volume level.
CHANNEL	Sets up or edits a channel.
TIME	Sets the time and time-related features.
LOCK	Locks or unlocks a channel or a program.
OPTION	Customizes the general settings.
NETWORK	Sets the network.
SUPPORT	Shows the projector information.

PICTURE Settings

- 1 Press the  (**Home**) button and select **SETTINGS**.
- 2 Use the \triangle or ∇ buttons to select **PICTURE** and press the  **Wheel (OK)** button.
- 3 Use the \triangle , ∇ , \triangleleft , or \triangleright button to set up the desired item and press the  **Wheel (OK)** button.
 - To return to the previous menu, press the  button.

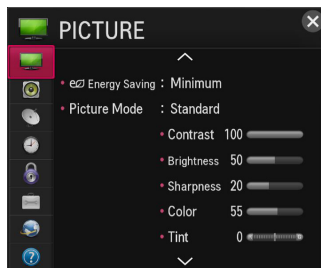

The available picture settings are described as follows.

Menu	Description	
Energy Saving	Reduces power consumption by adjusting peak screen brightness.	
	MODE	
	Minimum/ Medium/ Maximum	Applies the pre-set Energy Saving mode. <ul style="list-style-type: none"> – If Energy Saving is set to Minimum and the ambient temperature is 35 °C or higher, Energy Saving will be disabled.

Menu	Description	
Picture Mode	Selects the picture mode optimized for the viewing environment or the program. You can also customize advanced options for each mode.	
	MODE	
	Vivid	Maximizes the visual effect of video. Heightens contrast, brightness, and sharpness to display vivid images.
	Standard	Displays images in standard levels of contrast, brightness, and sharpness.
	Cinema	Optimizes the image for a movie.
	Sport	Optimised picture mode for sport. The pitch and kits are presented in vibrant colors, with crystal-clear images even for fast movements.
	Game	Optimizes the image for playing games on fast-moving screens.
Expert1 / Expert2	Menu for adjusting picture quality that allows experts and amateurs to enjoy the best projector viewing. – Expert mode is for picture tuning professionals to control and fine-tune using a specific image. For normal images, the effects may not be dramatic.	
Contrast	Adjusts the difference between bright and dark regions of the screen.	
Brightness	Adjusts the overall screen brightness.	
Sharpness	Adjusts the sharpness of the borders between bright and dark. Horizontal and Vertical Sharpness are available only in Expert1 / Expert2 .	
Color	Adjusts the colors on the screen darker or lighter.	
Tint	Adjusts the red/green color balance.	
Advanced Control (Expert Control)	Customizes the advanced settings.	

Menu	Description
Picture Option	Sets optional settings.
Picture Reset	Resets values customized by the user. Each picture mode is reset. Select the picture mode you wish to reset.
Aspect Ratio	Resizes the picture.
Picture Wizard III	Use the remote control and follow the instructions of the Picture Wizard to calibrate and adjust for optimum picture quality without expensive pattern devices or help from a specialist. Follow the instructions to obtain the optimum picture quality.

Advanced Control

Menu	Description	
Dynamic Contrast	Adjusts contrast and color to the optimal level according to the screen's brightness.	
Dynamic Color	Adjusts colors for more natural-looking colors.	
Color Gamut	<p>Selects the range of colors that can be expressed.</p> <ul style="list-style-type: none"> • Standard: Displays the original colors of an input signal regardless of the display features. • Wide: Makes use of the display's rich colors. 	
Preferred Color	Skin Color	Skin color spectrum can be separately set to implement the skin color as defined by the user.
	Grass Color	Natural color spectrum (meadows, hills, etc.) can be set separately.
	Sky Color	Sky color is set separately.
Super Resolution	Provides a crystal-clear picture by improving the details in areas where the picture is blurry or unclear.	
Gamma	Sets the gradation curve according to the output of the picture signal in relation to the input signal.	

Expert Control

Menu	Description
Dynamic Contrast	Adjusts contrast and color to the optimal level according to the screen's brightness.
Super Resolution	Provides a crystal-clear picture by improving the details in areas where the picture is blurry or unclear.
Color Gamut	<p>Selects the range of colors that can be expressed.</p> <ul style="list-style-type: none"> • Standard: Displays the original colors of an input signal regardless of the display features. • Wide: Makes use of the display's rich colors.
Edge Enhancer	Shows clearer and distinctive yet natural edges of the video.
Color Filter	Filters a specific color spectrum in RGB colors to fine-tune color saturation and hue accurately.
Expert Pattern	Patterns used for expert adjustment.
Gamma	Sets the gradation curve according to the output of the picture signal in relation to the input signal.
White Balance	<p>Adjusts white balance. Detailed adjustment is possible as shown below.</p> <p>a. Method 2 Points</p> <ul style="list-style-type: none"> – Pattern Inner, Outer – Points Low, High – Red/Green/Blue The adjustment range for each color is from -50 to +50. – Apply to all inputs The values of the White Balance is applied to all the input modes. <p>b. Method 20 Point IRE</p> <ul style="list-style-type: none"> – Pattern Inner, Outer – IRE (Institute of Radio Engineers) is the unit indicating the size of a video signal and can be set to 5,10,15, ... 100. You can fine-tune for each setting as shown below. – Red/Green/Blue The adjustment range is -50 to +50. – Apply to all inputs The values of the White Balance is applied to all the input modes.

Menu	Description
Color Management System	<p>Adjusts Red/Green/Blue/Cyan/Magenta/Yellow colors. Allows an expert to adjust the tint using a test pattern. Six colors (Red/Green/Blue/Cyan/Magenta/Yellow) can be selectively adjusted without affecting other colors. You may not see colors change on a normal picture even after adjustment.</p> <ul style="list-style-type: none">– Saturation Red/Green/Blue/Cyan/Magenta/Yellow,Tint Red/Green/Blue/Cyan/Magenta/Yellow,Luminance Red/Green/Blue/Cyan/Magenta/Yellow: <p>The adjustment range is -30 to +30 each.</p>











* Depending on input signal or other picture settings, the range of detailed items for adjustment may differ.

Picture Option

Menu	Description	
Noise Reduction	Reduces screen noise in the video.	
MPEG Noise Reduction	Eliminates noise generated while creating digital picture signals.	
Black Level	Adjusts the brightness or darkness of the screen to suit the black level of the picture input using the degree of darkness (black level) of the screen.	
Real Cinema	Optimizes the screen for movie viewing.	
TruMotion	Corrects images to display smoother motion sequences.	
	Mode	
	Smooth	De-Judder value is set to 3.
	Clear	De-Judder value is set to 7.
	User	De-Judder can be set manually. <ul style="list-style-type: none"> • De-Judder This function adjusts juddering of the screen.
Off	De-Judder value is set to 0.	
Color Temperature	Adjusts the overall color of the screen to suit your preference. Select Warm , Natural , Cool , or Medium .	

* If the video signal is 60 Hz, **TruMotion** may not work.

SOUND Settings

- 1 Press the  (**Home**) button and select **SETTINGS**.
- 2 Use the  or  buttons to select **SOUND** and press the  **Wheel (OK)** button.
- 3 Use the , , , or  button to set up the desired item and press the  **Wheel (OK)** button.
 - To return to the previous menu, press the  button.

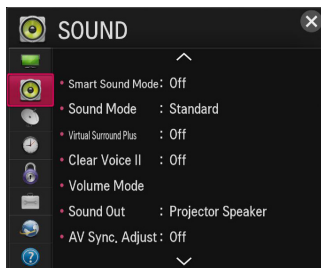











The available sound settings are described as follows.

Menu	Description	
Smart Sound Mode	Provides the optimized sound adjusted for each content type. <ul style="list-style-type: none"> • If the Smart Sound Mode function is enabled, Sound Mode, Virtual Surround Plus and Clear Voice II are automatically adjusted. 	
Sound Mode	Sets the sound mode.	
	Mode	
	Standard	Suitable for all types of video.
	News / Music / Cinema / Sport / Game	Sets audio optimized for a specific genre.
	Adjusts volume level. <ul style="list-style-type: none"> • 100 Hz / 300 Hz / 1 kHz / 3 kHz / 10 kHz: Sets EQ by manual adjustment of sound bands. • Reset: Resets the equalizer value changed by the user. 	
Virtual Surround Plus	Provides realistic 5.1 channel stereo sound from two speakers. <ul style="list-style-type: none"> • If Clear Voice II is set to On, Virtual Surround plus will not be chosen. 	

Menu	Description	
Clear Voice II	Boosts voice clarity.	
Volume Mode	Sets various modes for volume control.	
	Mode	
	Auto Volume	Sets Auto Volume to On . The volume varies from channel to channel and program to program. When clicking through the channels, the volume is adjusted automatically to maintain the same level.
Sound Out	Sets the audio output of the projector.	
	Mode	
	Projector Speaker	Sound is output through the projector speaker.
	External Speaker (Optical/HDMI ARC)	Sound is output through the speaker connected to the optical port. SIMPLINK is supported. <ul style="list-style-type: none"> • Digital Sound Out Sets up Digital Sound Output.
	LG Sound Sync (Optical)	Sound is output through an LG audio device connected to the OPTICAL DIGITAL AUDIO OUTPUT port.
	Bluetooth	Sound output is through the Bluetooth device.
	Headphone	Sound is output through headphones. <ul style="list-style-type: none"> • Headphones are detected and connected automatically when the projector is on.

Menu	Description	
AV Sync. Adjust	Synchronizes video and audio directly when they do not match. If you set AV Sync. Adjust to ON , you can adjust the sound output (projector speaker, SPDIF, or Bluetooth) to the screen image.	
	Mode	
	Projector Speaker	Adjusts the synchronization of the sound from the projector's internal speakers. The + and - buttons allow the viewer to synchronize the audio with the video.
	External Speaker	Adjusts how the sound is synced to external speakers, such as an external speaker connected to the digital audio output port, LG audio device, projector speaker, SPDIF, and headphone. The + and - buttons allow the viewer to synchronize the audio with the video.
	Bluetooth	Adjusts the synchronization between the video and the Bluetooth device sound. – This feature is only available when a Bluetooth device is connected. – Audio sync may vary by manufacturer. – When playing video and music from a connected USB drive, AV Sync. Adjust can also be adjusted using the Set Audio. menu.
Bypass	Outputs broadcasting signals or the audio of an external device without audio delay. Audio may be output before video as it takes time to process video input into the projector.	
Sound Option Setting	Balance Adjusts left/right audio balance.	

CHANNEL Settings



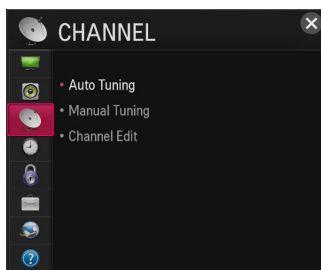

- 1 Press the  (**Home**) button and select **SETTINGS**.
- 2 Use the  or  button to select **CHANNEL** and press the  **Wheel (OK)** button.
- 3 Use the , , , or  button to set up the desired item and press the  **Wheel (OK)** button.
 - To return to the previous menu, press the  button.



The available channel settings are described as follows.

Menu	Description
Auto Tuning	<p>Remembers a channel which is currently broadcasting. You should use this function when you move to another house or move the projector to other place. It must be used while the antenna is connected and there are channel broadcasting signals.</p> <ul style="list-style-type: none"> • Channels are not registered properly unless the antenna/cable is connected correctly. • Auto Tuning finds only programs that are currently broadcasting. • If Lock System is turned on, a pop-up window will appear asking for password.
Manual Tuning	<p>Adjusts programs manually and saves the results. For digital broadcasting, signal strength, and signal quality can be checked.</p>
Channel Edit	<p>Edits the saved channels. Set as favorite channel, block/unblock channel, delete channel etc., of the selected channel.</p>

TIME Settings

- 1 Press the  (**Home**) button and select **SETTINGS**.
- 2 Use the \triangle or ∇ button to select **TIME** and press the  **Wheel (OK)** button.
- 3 Use the \triangle , ∇ , \triangleleft , or \triangleright button to set up the desired item and press the  **Wheel (OK)** button.
 - To return to the previous menu, press the  button.

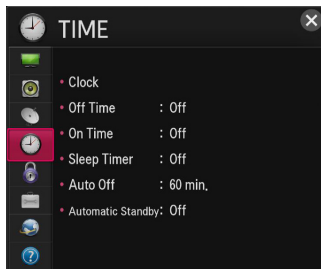





The available time settings are described as follows.

Menu	Description			
Clock	Checks or changes the time while watching projector.			
	Mode			
	<table border="1" style="width: 100%;"> <tr> <td style="width: 20%;">Auto</td> <td>Synchronizes the projector clock to the digital time information sent by the TV station.</td> </tr> <tr> <td>Manual</td> <td>Sets the time and date manually if the auto setup does not correspond to the current time.</td> </tr> </table>	Auto	Synchronizes the projector clock to the digital time information sent by the TV station.	Manual
Auto	Synchronizes the projector clock to the digital time information sent by the TV station.			
Manual	Sets the time and date manually if the auto setup does not correspond to the current time.			
Off Time/ On Time	<p>Sets On/Off time. Select Off on Repeat to discontinue On Time/Off Time.</p> <ul style="list-style-type: none"> • To use On Time/Off Time, set the current time correctly. • Even when the On Time function is on, the projector will turn off automatically in 120 minutes when no button is pressed within that time. 			
Sleep Timer	Turns off the projector after a preset number of minutes. To cancel the Sleep Timer , select Off .			
Auto Off	If there is no input signal or button press, the projector automatically turns off after the preset time has elapsed.			
Automatic Standby	If you do not press any button on the projector or remote control for a certain period, the projector will automatically turns off.			

LOCK Settings

- The illustration of the menu may differ from the actual screen on the product. (Depending on country)

- Press the  (**Home**) button and select **SETTINGS**.
- Use the \triangle or ∇ button to select **LOCK** and press the  **Wheel (OK)** button.
 - To enter the **LOCK** menu, enter the preset 4-digit password. The initial password is set as **0000**.
- Use the \triangle , ∇ , \triangleleft , or \triangleright button to set up the desired item and press the  **Wheel (OK)** button.
 - To return to the previous menu, press the  button.

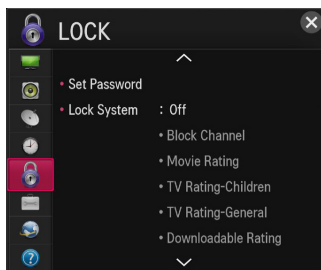

The available lock settings are described as follows.

Menu	Description	
Set Password	Sets or changes projector password. <ul style="list-style-type: none"> The initial password is set as 0000. 	
Lock System	Permits only specific programs by blocking channels or external input. Select the Lock System to On . <ul style="list-style-type: none"> This feature is available in certain countries only. 	
	Block Channel	Blocks the programs that contain inappropriate contents for children. The programs can be selected but the screen is blank and the audio is muted. To watch a locked program, enter the password.





Menu	Description	
Lock System	Movie Rating	<p>Blocks the movies that are only broadcast on the TV and contain inappropriate contents, based on the Motion Picture Association of America (MPAA) rating.</p> <ul style="list-style-type: none"> • G (General audiences) All ages admitted • PG (Parental guidance suggested) Some material may not be suitable for children • PG-13 (Parents strongly cautioned) Some material may be inappropriate for children under 13 • R (Restricted) Under 17 requires accompanying parent or adult guardian • NC-17 No one 17 and under admitted. • X Adults only
	TV Rating-Children	<p>Blocks the children's TV programs that parents do not want their children to watch. To block other TV programs, you should set the TV Rating-General feature.</p> <ul style="list-style-type: none"> • Age TV-Y (All children, including children from ages 2-6), TV-Y7 (Directed to older children, suitable for children age 6 and above) • Fantasy Violence TY-Y7 (Directed to older children - Fantasy violence, suitable for children age 6 and above, containing more intense or combative fantasy violence)

Menu	Description	
Lock System	TV Rating-General	<p>Blocks the TV programs that you want based on the ratings by using the Parental Control Function (V-Chip). The V-Chip electronically reads TV program ratings and allows parents to block program that are unsuitable for children.</p> <ul style="list-style-type: none"> • Age TV-G (General audience, suitable for all ages) TV-PG (Parental guidance suggested, containing material that are unsuitable for younger children) TV-14 (Parents strongly cautioned, containing material that are unsuitable for children age 14 and under) TV-MA (Mature audience only, unsuitable for children age • Dialogue (suggestive dialogue) TV-PG or TV-14 • Language (coarse language)TV-PG, TV-14, or TV-MA • Sex (sexual situation) TV-PG, TV-14, or TV-MA • Violence TV-PG, TV-14, or TV-MA
	Downloadable Rating	<p>This function operates only when TV has received Region 5 Rating data. The name of the rating option may differ.</p>
	Input Block	Block the input sources.
	Application Lock	Lock the application.

Menu	Description	
Lock System	TV Rating-English	Selecting Canadian English rating system. <ul style="list-style-type: none"> • This feature is available in certain countries only. • E : Exempt • C : Children • C8+ : Children eight years and older • G : General programming, suitable for all audiences • PG : Parental Guidance • 14+ : Viewers 14 years and older • 18+ : Adult programming • Blocking Off : Permits all programs
	TV Rating-French	Selecting Canadian French rating system. <ul style="list-style-type: none"> • This feature is available in certain countries only. • E : Exempt • G : General • 8ans+ : General-Not convenient for little children • 13ans+ : Not convenient for children of 13 years and younger • 16ans+ : Not convenient for children of 16 years and younger • 18ans+ : This programs is only for adults • Blocking Off : Permits all programs

OPTION Settings

- The illustration of the menu may differ from the actual screen on the product. (Depending on country)

- Press the  (**Home**) button and select **SETTINGS**.
- Use the \triangle or ∇ button to select **OPTION** and press the  **Wheel (OK)** button.
- Use the \triangle , ∇ , \triangleleft , or \triangleright button to set up the desired item and press the  **Wheel (OK)** button.
 - To return to the previous menu, press the  button.

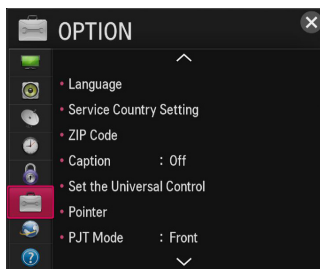

The available option settings are described as follows.

Menu	Description	
Language	Selects Menu Language , Audio Language and Voice Recognition Language displayed on the screen.	
	Item	
	Menu Language	Selects a screen menu language.
	Audio Language	Selects the desired language when watching digital broadcasting containing several audio languages. (In digital mode only)
	Voice Recognition Language	Select the language to make voice search.





Menu	Description	
Service Country Setting	<p>You can change the country setting of your smart projector. The premium service and LG Smart World that are available for the country you selected will be provided.</p> <ul style="list-style-type: none"> • If a network is disconnected while setting the service country, it may not be set properly. 	
	Item	
	Auto Setting	A service country is automatically set for your smart projector.
	Manual Setting	A service country can be set manually for your smart projector.
ZIP Code	<p>You can check the information of area when network is connected.</p> <ul style="list-style-type: none"> • This feature is available in certain countries only. • This function sets your area as the ZIP Code. • You can check the information of area when network is connected. 	
Caption	<p>View subtitles when the TV station provides subtitled programming. Program subtitles work only on digital/ analog broadcasts or external input. Change Caption to On and select caption setting.</p>	
	Mode	<p>CC 1-4 (Closed Captioning) / Text 1-4 Displays the audio portion of a TV program as text on the TV screen. CC 1 is the most common mode in use. Field 1 data channels: two Captions (CC 1, CC 2), two Text (Text 1, Text 2). Field 2 data channels: two Captions (CC 3, CC 4), two Text (Text 3, Text 4). Service1-6 This is only available for the digital broadcasting system.</p>

Menu	Description		
Caption	Digital Option	Set up the size and color of the subtitles on Digital Option . Please select Set by Program or Custom . Select Custom to adjust minute options such as the subtitles' size and color.	
		Item	
		Size	Selects the wordsize.
		Font	Selects a typeface for the text.
		Text Color	Selects a color for the text.
		Text Opacity	Adjusts the opacity for the text color.
		Bg Color	Selects a color for the background color.
		Bg Opacity	Adjusts the opacity for the background color.
		Edge Type	Selects an edge type.
		Edge Color	Selects a color for the edges.
		Window Color	Selects a color for the window color.
		Window Opacity	Adjust the opacity for the window color.
Set the Universal Control	With the magic remote control, you can control a set-top box, Bluray player, home theater system, etc. <ul style="list-style-type: none"> This feature is available in certain countries only. 		

Menu	Description	
Pointer	Sets the speed and shape of the pointer that appears on the projector screen.	
	Speed	Sets the moving speed of the pointer.
	Shape	Selects a pointer shape from various options.
	Size	Chooses the size of the pointer.
	Alignment	Set to On . If there is any misalignment between the pointer and the actual direction the remote control indicates, move the Magic Remote control left and right to realign. The pointer will automatically realign to the center, making it easier to control. <ul style="list-style-type: none"> • If it is set to Off, the alignment function will not work even when you move the magic remote control left and right.
PJT Mode	This function turns the projected image upside down or flips horizontal.	
Auto Keystone (Vertical)	Auto Keystone(Vertical) provides a rectangular screen image by automatically adjusting the keystone number when there is a trapezoidal screen image caused by tilting of the projector.	
	When using Auto Keystone(Vertical) , the current value set for Edge Adj is changed to the value that has been set with Auto Keystone(Vertical) .	
	Item	
	On	Automatically adjusts the keystone number.
Off	Manually adjusts the keystone number.	
Edge Adj	To prevent the screen image from becoming trapezoidal, Edge Adj adjusts the top and bottom width of the image if the projector is not set at a right angle to the screen.	

Menu	Description	
Auto Power	Makes the projector turn on automatically when the power code is connected to the projector.	
	Item	
	On	When the power code is connected to the projector, it turns on automatically.
	Off	When the power code is connected to the projector, it goes into standby mode.
High Altitude	If the projector is used at an altitude higher than 1200 meters, turn this on. Otherwise, the projector may overheat or its protection function may be activated. If this happens, turn the projector off and then on again after waiting for several minutes.	
Auto Input Search	Automatically searches for and displays the input signal type when it is received. It is available only with external inputs (HDMI, AV, and Component).	
Balloon Help	Enables/disables the balloon help.	
Control Device List	Displays the list of control devices connected to the projector.	
See Avatar	Turns the Avatar function on or off.	
Initial Setting	<p>Deletes all optional settings and returns to initial default mode. Once initialization is complete, the projector will turn off and on by itself.</p> <ul style="list-style-type: none"> • If Lock System is activated, a pop-up password prompt will appear. • Do not turn off the power during initialization. 	
Mode Setting	Selects Standard or Store . For use at home, select Standard . Store is a mode used for store display.	

NETWORK Settings

- 1 Press the  (**Home**) button and select **SETTINGS**.
- 2 Use the \triangle or ∇ button to select **NETWORK** and press the  **Wheel (OK)** button.
- 3 Use the \triangle , ∇ , \triangleleft , or \triangleright button to set up the desired item and press the  **Wheel (OK)** button.
 - To return to the previous menu, press the  button.

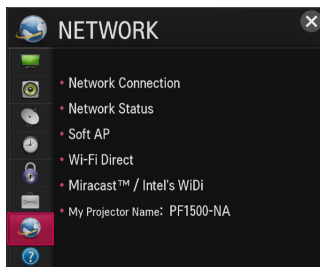





The available network settings are described as follows.

Menu	Description	
Network Connection	Connects a network.	
Network Status	Displays the connection status of the network.	
Soft AP	This function allows you to change a wired Internet connection to your projector to Wi-Fi, allowing you to connect various external devices or to use wireless Internet.	
	Soft AP	Sets to On/Off .
	Security Key	Sets the Wi-Fi security number. <ul style="list-style-type: none"> • You can set the security key with a combination of English letters and numbers between 8 and 64 characters long. • The default setting is LG123456.
	<ul style="list-style-type: none"> • To enable the Soft AP function, your projector must be turned on and have a wired Internet connection. • Up to four external devices can be connected. • If the Soft AP function is enabled, the Wi-Fi Direct and Miracast™ functions become unavailable. You must set the Soft AP function to Off to use the Wi-Fi Direct and Miracast™ functions. 	

Menu	Description
Wi-Fi Direct	Wi-Fi Direct is a function that allows your projector to connect with a Wi-Fi Direct device without Internet connection.
Miracast™ / Intel's WiDi	The Miracast™ allows you to enjoy video and audio from a portable device through the projector wirelessly. Intel's WiDi allows you to view a laptop screen through the projector without a cable.
My Projector Name	Changes the name that appears when searching for the projector from other devices.

SUPPORT

- The illustration of the menu may differ from the actual screen on the product. (Depending on country)

- Press the  (**Home**) button and select **SETTINGS**.
- Use the \triangle or ∇ button to select **SUPPORT** and press the  **Wheel (OK)** button.
- Use the \triangle , ∇ , \triangleleft , or \triangleright button to set up the desired item and press the  **Wheel (OK)** button.
 - To return to the previous menu, press the  button.

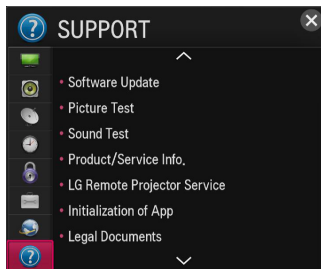

The available support settings are described as follows.

Menu	Description
Software Update	Updates to the latest software.
Picture Test	Check whether a video signal is properly displayed.
Sound Test	Check whether an audio signal is properly output.
Product/Service Info.	Shows the product/service information.
LG Remote Projector Service	Remotely solve any question following an update by contacting the Service Center staff by phone. <ul style="list-style-type: none"> This feature is available in certain countries only.
Initialization of App	If problems occur after updates, try initializing the system. <ul style="list-style-type: none"> During initialization, the projector will restart automatically.
Legal Documents	You can check the contents of Legal Documents and you can make a choice whether to agree or withdraw your consent to Legal Documents .
Self Diagnosis	Troubleshoots functional problems that can arise while using the product.

CONNECTING DEVICES

You can connect various external devices to the projector.

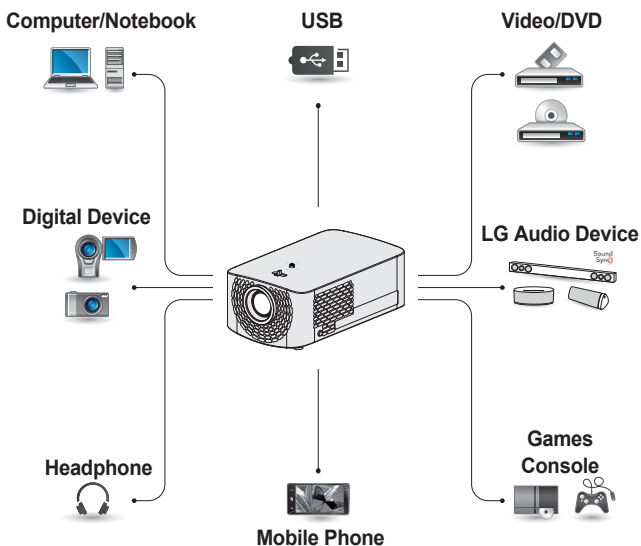

- HDMI - Page 120
- Composite (AV) - Page 121
- Component - Page 122
- USB Device - Page 55
- Headphone - Page 125
- Digital Amp - Page 126
- Mobile Phone (MHL) - Page 127

Connecting to HD Receiver, DVD, or VCR Player, External Devices

Connect an HD receiver, DVD, VCR player, or external devices to the projector and select an appropriate input mode.

HDMI Connection

With an HDMI cable, you can enjoy high quality picture and sound.

Using a HDMI cable, connect the **HDMI 1 ARC** port of the projector to the HDMI output port of the device to connect. Both video and audio are output at the same time.

You can also use the **HDMI 2 MHL**.

Press the **INPUT** button on the remote control to select **HDMI**.

You can connect with any HDMI input port.



NOTE

ARC(Audio Return Channel)

- External audio devices that support SIMPLINK and ARC must be connected using **HDMI 1 ARC** port.
- When connected with a high-speed HDMI® cable, external audio devices that support ARC output or SPDIF work with the SIMPLINK function without the need for an additional optical audio cable.

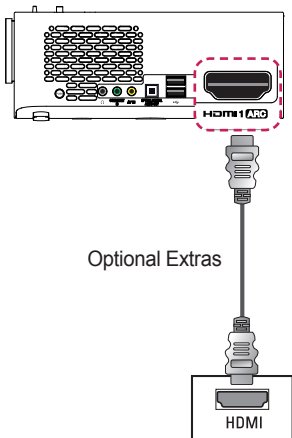

HDMI to DVI Connection

Using an HDMI to DVI cable, connect the projector's **HDMI 1 ARC** port to the DVI OUT port.

To output audio, use an audio cable for connection. You can also use the **HDMI 2 MHL**.

Press the **INPUT** button on the remote control to select **HDMI**. You can connect with any HDMI input port.

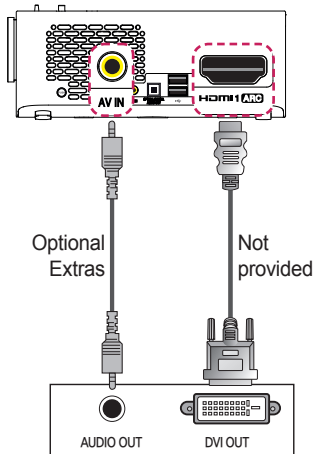

AV Connection

Connect the output ports of an external device and the **AV IN** ports of the projector using an AV cable. Press the **INPUT** button on the remote control to select **AV**. Check whether cables of the same color are connected properly.

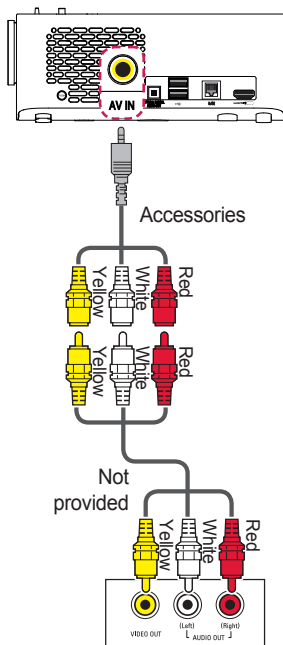

Component Connection

You can enjoy a video by connecting the component port of an external device to the **COMPONENT IN** port of the projector. Press the **INPUT** button on the remote control to select **Component**. Check whether cables of the same color are connected properly.

A)

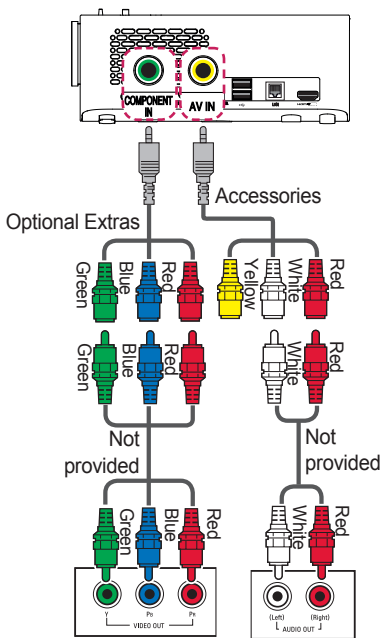

B)

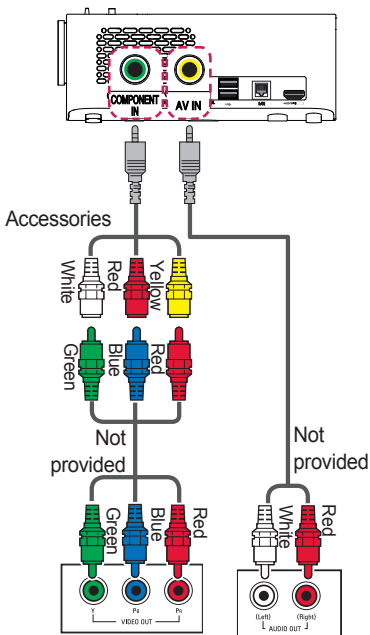

Connecting a PC

The projector supports Plug and Play. Your PC will automatically detect the projector and requires no driver installation.

HDMI Connection

Using an HDMI cable, connect the **HDMI 1 (ARC)** port of the projector to the HDMI output port of your PC. Both video and audio are output at the same time. You can also use the **HDMI 2 (MHL)**.

Press the **INPUT** button on the remote control to select **HDMI**. You can connect with any HDMI input port.

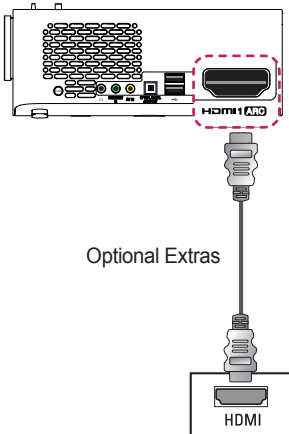

HDMI to DVI Connection

Using an HDMI to DVI cable, connect the projector's **HDMI 1 (ARC)** port to the DVI OUT port.

To output audio, use an audio cable for connection. You can also use the **HDMI 2 (MHL)**.

Press the **INPUT** button on the remote control to select **HDMI**. You can connect with any HDMI input port.

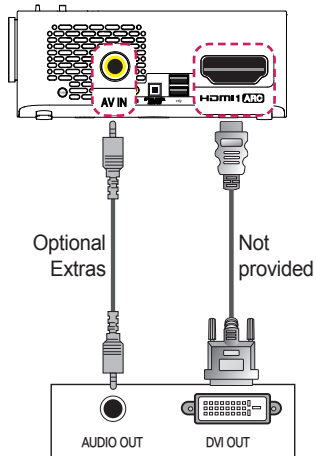



NOTE

- It is recommended to use an HDMI connection for the best image quality.
- Depending on the graphics card, DOS mode video may not work if a HDMI to DVI Cable is in use.
- In PC mode, there may be noise associated with the resolution, vertical pattern, contrast, or brightness. If noise is present, change the PC output to another resolution, change the refresh rate to another rate or adjust the brightness and contrast on the **PICTURE** menu until the picture is clear.
- The synchronization input form for Horizontal and Vertical frequencies is separate.
- Depending on the graphics card, some resolution settings may not allow the image to be positioned on the screen properly.
- If you are using DVI out from a PC, you have to connect analog audio separately.
- When using the HDMI/DVI cable, Single link only is supported.

Connecting a Laptop

You can connect the projector to a laptop to use various functions.

HDMI Connection

Using an HDMI cable, connect the **HDMI1 ARC** port of the projector to the HDMI output port of your laptop. Both video and audio are output at the same time. You can also use the **HDMI2 MHL**. Press the **INPUT** button on the remote control to select **HDMI**. You can connect with any HDMI input port.

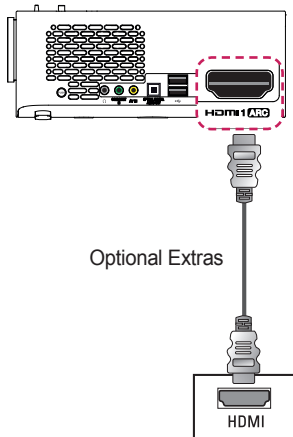

The table below shows examples of switching the output. For more information, refer to the **External Output, Connecting to an External Monitor**, or similar sections of the owner's manual of your computer.

Brand	Switching Output
NEC	[Fn]+[F3]
Panasonic	[Fn]+[F3]
Toshiba	[Fn]+[F5]
IBM	[Fn]+[F7]
Sony	[Fn]+[F7]
Fujitsu	[Fn]+[F10]
LG	[Fn]+[F7]
Samsung	[Fn]+[F4]
Macintosh	Adjust the control panel to enable mirroring after start-up.

Connecting Headphones

You can listen to the audio through a headphone.

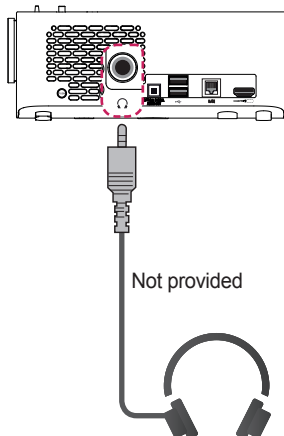

Connecting a Digital Amp

Using an optical cable, connect the digital audio input port of a digital amp to the **OPTICAL DIGITAL AUDIO OUT** port of the projector. The output of an amp with a digital converter must be set to the desired audio format. When using a HDMI cable to connect a home theater or when connecting an optical output to an external audio device, set **Sound Out to External Speaker (Optical/HDMI ARC)** as shown below. If a projector, home theater, or the speaker of an external audio device is operating at the same time, there will be an echo.

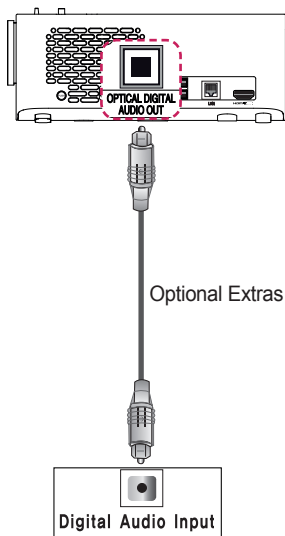

! NOTE

- Refer to the user manual of the audio device to connect.
- When connecting this product to other devices, make sure to turn off and unplug all the devices.
- The audio output of this product has wide-ranging audio bandwidth, so the receiver volume must be adjusted properly. Speakers can be damaged by unexpected high frequencies.
- Connecting the **OPTICAL DIGITAL AUDIO OUT** port of the projector to the digital audio input port of a digital amp and the audio input port of the projector to the analog audio output port of the digital amp can cause sound oscillation due to the closed loop. Remove one of the two connections to prevent this. (This also applies to home theater devices.)

Using the Mirroring Function of a Mobile Phone

MHL Connection

The Mobile High-definition Link (MHL) is an interface that can connect a mobile phone to the projector and play video and audio from the mobile phone through the projector.

This only applies to products with a HDMI input that supports MHL.

(To find out whether your device is MHL-certified, please contact your device manufacturer.)

For MHL support, check the **HDMI2 MHL** port.

Use a dedicated cable for MHL.

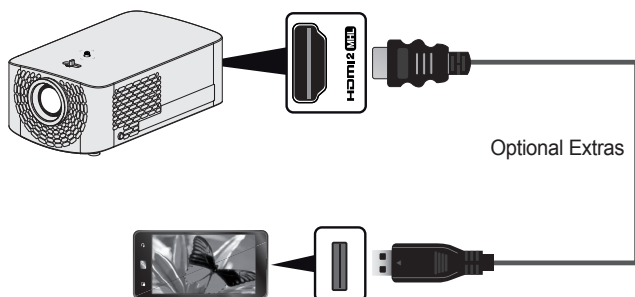

NOTE

- When you connect a mobile phone to the **HDMI2 MHL** port, you can see the mobile phone screen through a projector.
 - This only applies to mobile phones that support MHL.
 - You can use the remote control for some applications.
- Disconnect the MHL cable from the projector when:
 - The MHL function is disabled.
 - Your mobile device is fully charged in standby mode.

MAINTENANCE

Clean your Projector to keep it in optimal condition.

Cleaning

Cleaning the Lens

If there is any dust or staining on the lens surface, you must clean the lens.

Use an air spray or a cleaning cloth to clean the lens.

To remove dust or stains, use an air spray or apply a small amount of cleaning agent onto a swab or soft cloth to lightly rub the lens.

Please be aware that liquid may flow into the lens if the product is sprayed directly onto the lens.

Cleaning the Projector Case

To clean the projector case, first unplug the power cord.

To remove dust or stains, use only a dry, lint-free, nonabrasive cloth to polish the lens.

Do not use alcohol, benzene, thinners, or other chemicals, which may damage the case.

INFORMATION

To Update Projector Software

Uses Software Update to check and obtain the latest version.

It is also possible to check manually for available updates.

1 Press the  (**Home**) button and select **SETTINGS**.

2 Select **SUPPORT** and go to **Software Update**.

Item	Description
Software Update	Set it to On . If an update is available, a prompt will appear to perform the update.
Automatic Update Mode	If an update is available, the update automatically starts without prompting.
Check Update Version	Checks the latest update version installed. When a new update is available, the download process can be performed manually.

- When the update starts, the update progress window appears for a short time and disappears.
- The latest version can be obtained via an Internet connection.
- If software is not updated, certain functions may not work properly.

Before Reporting a Problem, Check the Following:

If the following symptoms occur, please carry out the checks and adjustments described below. There may be no malfunction.

General

Problem	Solution
Cannot view certain programs.	<ul style="list-style-type: none"> Adjust the location or orientation of the antenna. Save the programs you wish to view later using Auto Tuning or Channel Edit.
There is a delay after the projector is switched on before the image is fully visible.	<ul style="list-style-type: none"> This is not a problem. Image noise that may occur when the projector is first switched is being cleaned up.

Picture

 (Home) → **SETTINGS** → **SUPPORT** → **Picture Test**

First run a Picture Test to verify that the image signal output is normal.

If there is no problem with the test image, check external device connections and broadcast signals.

Problem	Solution
Images from previous program or other programs linger or the screen displays annoying lines.	<ul style="list-style-type: none"> Adjust the orientation of the antenna to the TV transmitter, or refer to the manual for instructions on connecting the antenna.
Vibrating horizontal/vertical lines and fishnet patterns appear momentarily.	<ul style="list-style-type: none"> Such a problem may happen when there is strong electronic interference. Turn off other electronic devices such as mobile phones, power tools, and other small electrical appliances.

Problem	Solution
The screen display freezes or does not work properly during a digital broadcast.	<ul style="list-style-type: none"> This may occur in case of a weak signal or unstable reception. Adjust the antenna orientation and cable connections. If the signal strength or quality is low on Manual Tuning, check with the TV station or administration office.
Digital broadcasting is not available even though the cable is connected.	<ul style="list-style-type: none"> Check with the cable operator providing your subscription and/or signal. (Depending upon your subscription, digital broadcasting may not be supported.)
The display is inactive or unclear when connected to an HDMI® source.	<ul style="list-style-type: none"> Check the HDMI® cable specifications. If your HDMI® cable is not genuine, images may fade in and out or not be displayed properly. Ensure that all cables are securely connected. When connections are not secure, images may not be properly displayed.
Does not work with a USB storage device.	<ul style="list-style-type: none"> Verify that the USB device and cable is version 2.0 or higher.

Sound

 (Home) → **SETTINGS** → **SUPPORT** → **Sound Test**

First run a Sound Test to verify that the sound signal output is normal.

If there is no problem with the test sound, check connected external devices and the broadcast signal.

Problem	Solution
Screen display is on but there is no sound.	<ul style="list-style-type: none"> Check other TV programs. Check if the audio output settings for the projector are configured correctly.

Problem	Solution
For an analogue broadcast, stereo is not clear or sound comes from one speaker only.	<ul style="list-style-type: none">• In a poor reception area (areas with weak or unstable signals) or if multi audio is not stable, select Mono on Multi Audio.• Adjust the balance using the navigation button.
TV sound is not in sync with the image or the sound breaks up occasionally.	<ul style="list-style-type: none">• If the issue affects a specific TV program only, it may be caused by problems with the broadcast signal for the individual station. Check with the TV station or your cable operator.
The volume changes when I change program.	<ul style="list-style-type: none">• Volume can vary from program to program.• Set Auto Volume to On.
On certain programs, there is no sound at all, or only the background music can be heard (in case of a programs created for overseas viewers).	<ul style="list-style-type: none">• In Language, set Language → Audio Language to the language of your choice. Even if you change the language on Multi Audio, you can go back to the default setup once you turn off the power or change the program.
There is no sound when connected to HDMI / USB.	<ul style="list-style-type: none">• Verify that the HDMI® cable is high speed.• Check if the USB device and cable is version 2.0 or higher.• Use only regular music (*.mp3) files.

PC Connection Problem

Problem	Solution
The screen display does not come on after connecting to the computer.	<ul style="list-style-type: none">• Verify that the computer and the projector are securely connected.• Turn the projector off and back on using the remote control.• Restart the PC with the projector on.• Check whether the resolution is correctly set for PC input.• Reconnect the HDMI cable.
There is no sound after connecting the computer with the HDMI cable.	<ul style="list-style-type: none">• Check with manufacturer of your video card to ensure it supports HDMI voice output. (Video cards in DVI format require connection of a separate sound cable.)
When connected to the computer, the display is partially cut off or shifts to one side.	<ul style="list-style-type: none">• Set the resolution to support PC input. (If this does not work, reboot the computer.)

Problems Replaying Movies in My Media

Problem	Solution
<p>I cannot view the files on the Movie List.</p>	<ul style="list-style-type: none"> • Check whether the file on the USB storage device can be read on a computer. • Check whether the file extension is supported.
<p>This file is invalid. message appears or the image display is not normal even though the sound is OK.</p>	<ul style="list-style-type: none"> • Make sure that the file replays normally on the computer's video player. (Check for damaged files.) • Check whether the resolution is supported by the computer. • Verify that the video/audio codec is supported. • Verify that the frame rate is supported.
<p>Audio not supported. message appears or the sound is not normal even though the image display is OK.</p>	<ul style="list-style-type: none"> • Make sure that the file replays normally on the computer's video player. (Check for damaged files.) • Check if the audio codec is supported by the computer. • Verify that the bit rate is supported. • Verify that the sample rate is supported.
<p>Subtitles are not displayed.</p>	<ul style="list-style-type: none"> • Make sure that the file replays normally on the computer's video player. (Check for damaged files.) • Check if the video file has the same name as the subtitle file. • Make sure that the video and subtitle files are in the same folder. • Verify that the subtitle file format is supported. • Verify that the subtitle language is supported. (Subtitle files can be opened in Notepad to check the language.)

- Image shown may differ from your projector.
- For information on requesting service, refer to the following menu.
 (Home) → **SETTINGS** → **SUPPORT** → **Product/Service Info.**

SPECIFICATIONS

MODELS	PF1500 (PF1500-NA)
Resolution (Pixel)	1920 (Horizontal) × 1080 (Vertical)
Aspect Ratio	16:9 (Horizontal:Vertical)
Panel size (mm)	11.896
Projection Distance (Video size)	Wide : 0.91 m to 3.70 m (76.2 cm to 304.8 cm) Tele : 0.91 m to 3.70 m (69.3 cm to 277.1 cm)
Ratio of Upward Projection	100 %
Working range of the remote control	6 m
Power	AC 100 - 240 V, 50 Hz/ 60 Hz
Power consumption	100 W
AC-DC Adaptor	19 V  5.79 A (Adaptor Input 100 - 240 V @ 50/60 Hz)
Audio Output	3 W + 3 W
Reception type	NTSC-M, ATSC
Reception channels	VHF 02 to 13, UHF 14 to 69, CATV 01 to 135, DTV 02 to 69, CADTV 01 to 135
External Antenna Impedance	75 Ω
Height (mm)	84 (without foot) / 87 (with foot)
Width (mm)	132
Depth (mm)	213 (without lens) / 220 (with lens)
Weight (g)	1500
USB Device	5 V, 0.5 A (Max.)

MODELS	PF1500 (PF1500-NA)	
Environment Condition	Temperature	
	Operation	0 °C to 40 °C
	Storage	-20 °C to 60 °C
	Relative humidity	
	Operation	0 % to 80 %
	Storage	0 % to 85 %

* Use only power supplies listed in the user instructions.

* Contents in this manual may be changed without prior notice due to upgrade of product functions.

HDMI (DTV) Supported Mode

Resolution	Horizontal Frequency (kHz)	Vertical Frequency (Hz)
720 x 480p	31.469	59.94
	31.50	60.00
1280 x 720p	44.96	59.94
	45.00	60.00
1920 x 1080i	33.72	59.94
	33.75	60.00
1920 x 1080p	26.97	23.97
	27.000	24.000
	33.716	29.976
	33.75	30.00
	67.43	59.94
	67.500	60.00

Supported HDMI (PC) Modes

Resolution	Horizontal Frequency (kHz)	Vertical Frequency (Hz)
640 x 480	31.469	59.94
800 x 600	37.879	60.31
1024 x 768	48.363	60.00
1152 x 864	54.348	60.053
1360 x 768	47.712	60.015
1280 x 1024	63.981	60.020
1920 x 1080	67.5	60.00

- If an invalid signal is input into the projector, it will not be displayed properly on the screen or a message such as **No Signal** or **Invalid Format** will be displayed.
- The projector supports the DDC1/2B type as the Plug and Play function (Auto-recognition of PC monitor).
- 1920 x 1080 is recommended as the best picture quality in the PC mode.

Component Supported Mode

Resolution	Horizontal Frequency (kHz)	Vertical Frequency (Hz)
720 x 480i	15.73	59.94
	15.75	60.00
720 x 480p	31.47	59.94
	31.50	60.00
1280 x 720p	44.96	59.94
	45.00	60.00
1920 x 1080i	33.72	59.94
	33.75	60.00
1920 x 1080p	26.97	23.976
	27.00	24.00
	33.71	29.97
	33.75	30.00
	67.432	59.94
	67.500	60.00

Component Port Connecting Information

Component ports on the Projector	Y	P _B	P _R
Video output ports on DVD player	Y	P _B	P _R
	Y	B-Y	R-Y
	Y	Cb	Cr
	Y	Pb	Pr







Open Source Software Notice Information

To obtain the source code under GPL, LGPL, MPL and other open source licenses, that is contained in this product, please visit <http://opensource.lge.com>.

In addition to the source code, all referred license terms, warranty disclaimers and copyright notices are available for download.

LG Electronics will also provide open source code to you on CD-ROM for a charge covering the cost of performing such distribution (such as the cost of media, shipping, and handling) upon email request to opensource@lge.com. This offer is valid for three (3) years from the date on which you purchased the product.

SYMBOLS

	Refers to alternating current(AC).
	Refers to direct current(DC).
	Refers to class II equipment.
	Refers to stand-by.
	Refers to "ON" (power).
	Refers to dangerous voltage.



The model and serial numbers of the projector are located on the back or on the side of the projector. Record them below should you ever need service.

MODEL _____

SERIAL _____