



**LG**

Life's Good

# OWNER'S MANUAL PLASMA TV

Please read this manual carefully before operating the set and retain it for future reference.

PA45\*\*

PA49\*\*

PA55\*\*

PA65\*\*

# LICENSES

Supported licenses may differ by model. For more information about licenses, visit [www.lg.com](http://www.lg.com).



Manufactured under license from Dolby Laboratories. “Dolby” and the double-D symbol are trademarks of Dolby Laboratories.



HDMI, the HDMI logo and High-Definition Multimedia Interface are trademarks or registered trademarks of HDMI Licensing LLC.



**ABOUT DIVX VIDEO:** DivX® is a digital video format created by DivX, LLC, a subsidiary of Rovi Corporation. This is an official DivX Certified® device that plays DivX video. Visit [divx.com](http://divx.com) for more information and software tools to convert your files into DivX video.

**ABOUT DIVX VIDEO-ON-DEMAND:** This DivX Certified® device must be registered in order to play purchased DivX Video-on-Demand (VOD) movies. To obtain your registration code, locate the DivX VOD section in your device setup menu. Go to [vod.divx.com](http://vod.divx.com) for more information on how to complete your registration.

“DivX Certified® to play DivX® video up to HD 1080p, including premium content.”

“DivX®, DivX Certified® and associated logos are trademarks of Rovi Corporation or its subsidiaries and are used under license.”

Covered by one or more of the following U.S. patents :  
7,295,673; 7,460,668; 7,515,710; 7,519,274



## NOTE

- Image shown may differ from your TV.
- Your TV's OSD (On Screen Display) may differ slightly from that shown in this manual.



# TABLE OF CONTENTS

## 2 LICENSES

---

## 6 INSTALLATION PROCEDURE

---

### 6 ASSEMBLING AND PREPARING

---

- 6 Unpacking
- 9 Separate purchase
- 9 Parts and buttons
- 11 Lifting and moving the TV
- 12 Setting up the TV
  - 12 - Attaching the stand
  - 14 - Mounting on a table
  - 15 - Mounting on a wall
  - 16 - Tidying cables

### 17 REMOTE CONTROL

---

### 19 WATCHING TV

---

- 19 Connecting an antenna
- 19 Turning the TV on for the first time
- 20 Watching TV
- 20 Managing programmes
  - 20 - Automatically setting up programme
  - 22 - Cable DTV Setting (In Cable mode only)
  - 22 - Manually setting up programme (In digital mode)
  - 23 - Manually setting up programme (In analogue mode)
  - 24 - Editing your programme list
  - 26 - CI [Common interface] Information
  - 27 - Selecting the programme list
- 28 EPG (Electronic Programme Guide) (In digital mode)
  - 28 - Switch on/off EPG
  - 28 - Select a programme
  - 29 - NOW/NEXT Guide Mode
  - 29 - 8 Day Guide Mode
  - 29 - Date Change Mode
  - 29 - Extended Description Box

- 29 - Remind Setting Mode
- 30 - Schedule List Mode
- 30 Using additional options
  - 30 - Adjusting aspect ratio
  - 32 - Changing AV modes
  - 32 - Using the input list
  - 33 - Locking the buttons on the TV (Child Lock)
- 34 Using the quick menu
- 35 Using the customer support
  - 35 - Testing Software Update
  - 36 - Testing the Picture / Sound
  - 36 - Using Signal Test
  - 36 - Using the product or service information

### 37 PENTOUCH

---

- 37 Using Pentouch
  - 38 - Step of using the Pentouch program
  - 38 - System Requirements
  - 38 - Installing the Pentouch Program
  - 39 - Removing the Pentouch Program
  - 39 - Pairing between Touch Pen and Dongle
  - 43 - Using the Pentouch Function
  - 43 - Display Resolution Settings for Pentouch
- 45 Checking the Pentouch Functions
  - 46 - Using Toolbar
  - 47 - Using Sketchbook
  - 49 - Using Photo Editor
  - 51 - Using Family Diary
  - 51 - Using Gallery
  - 52 - Using Internet
  - 53 - Using the My Office function

### 54 NETWORK SETTING

---

- 54 - Connecting to a wired network
- 55 - Network Status

### 56 ENTERTAINMENT

---

- 56 - Connecting USB storage devices
- 57 - Browsing files
- 58 - Viewing movies
- 61 - Viewing photos
- 63 - Listening to music
- 65 - DivX® VOD Guide

## 66 CUSTOMIZING TV SETTING

---

- 66 Accessing main menus
- 67 Customizing settings
- 67 - PICTURE settings
- 72 - AUDIO settings
- 75 - SETUP settings
- 76 - TIME settings
- 77 - LOCK settings
- 78 - OPTION settings
- 80 - NETWORK Settings

## 81 MAKING CONNECTIONS

---

- 82 Connection overview
- 83 Connecting to a HD receiver, DVD, or VCR player
- 83 - HDMI Connection
- 84 - DVI to HDMI Connection
- 85 - Component Connection
- 86 - Euro Scart connection
- 87 - Composite Connection
- 88 Connecting to a PC
- 88 - HDMI Connection, DVI to HDMI Connection or RGB Connection
- 90 Connecting to an Audio System
- 90 - Digital Optical Audio Connection
- 91 Connecting to a USB
- 91 Connecting to a CI Module
- 92 SIMPLINK connection
- 92 - Activating the SIMPLINK feature

## 93 TELETEXT

---

- 93 Switch On/Off
- 93 Simple Text
- 93 - Page selection
- 93 Top Text
- 93 - Block / Group / Page Selection
- 93 - Direct Page Selection
- 94 Fastext
- 94 - Page selection
- 94 Special Teletext Function

## 95 DIGITAL TELETEXT

---

- 95 Teletext within digital service
- 95 Teletext in digital service

## 96 MAINTENANCE

---

- 96 Cleaning your TV
- 96 - Screen and frame
- 96 - Cabinet and stand
- 96 - Power cord
- 97 Preventing "Image burn" or "Burn-in" on your TV screen

## 98 TROUBLESHOOTING

---

## 100 SPECIFICATIONS

---

### 103 IR CODES

---

### 104 EXTERNAL CONTROL DEVICE SETUP

---

- 104 RS-232C Setup
- 104 Type of connector; D-Sub 9-Pin Male
- 104 RS-232C Configurations
- 105 Communication Parameters
- 105 Command reference list
- 106 Transmission / Receiving Protocol

### 111 OPEN SOURCE LICENSE

---

- 111 Open source software notice

# INSTALLATION PROCEDURE

- 1 Open the package and make sure all the accessories are included.
- 2 Attach the stand to the TV set.
- 3 Connect an external device to the TV set.

## ASSEMBLING AND PREPARING

### Unpacking

Check your product box for the following items. If there are any missing accessories, contact the local dealer where you purchased your product. The illustrations in this manual may differ from the actual product and item.

Only 42/50PA45\*\*, 50/60PA55\*\*, 50/60PA65\*\*

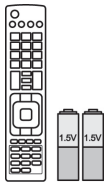

**Remote control,  
Batteries (AAA)**(See p.17)

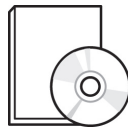

**Owner's manual,  
CD manual**



**Cable Holder**(See p.16)

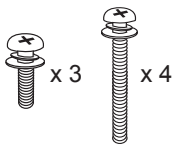

M5 x 16 M4 x 30  
**Screw for assembly**  
(See p.12, See p.13)



**Power Cord Holder**(See p.16)



**Power Cord**



**Protection Cover**(See p.13)

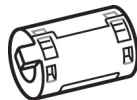

**Ferrite core**  
(Depending on model)



**Polishing cloth**  
(Depending on model)  
Gently wipe the spots on the cabinet with the polishing cloth.



**Stand Body**(See p.12)

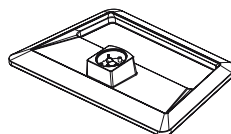

**Stand Base**(See p.12)

Only 42/50PA49\*\*

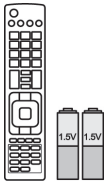

**Remote control,  
Batteries (AAA)**(See p.17)

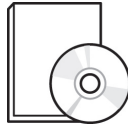

**Owner's manual,  
CD manual**



**Pentouch Caution Guidelines**

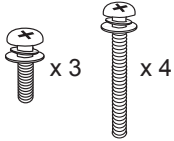

M5 x 16 M4 x 30  
**Screw for assembly**  
(See p.12, See p.13)



**Power Cord Holder**(See p.16)

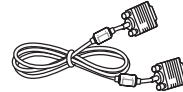

**D-sub 15 pin signal cable**

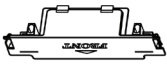

**Protection Cover**(See p.13)

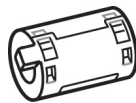

**Ferrite core**  
(Depending on model)



**Power Cord**



**Cable Holder**(See p.16)

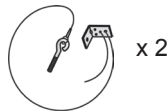

**Eye-bolt , Wall bracket**  
(See p.14)



**Polishing cloth**  
(Depending on model)  
Gently wipe the spots on the cabinet with the polishing cloth.



**Charging Cable**(See p.42)



**Tip**(See p.42)  
The number of tip may differ depending on the model.



**Touch Pen (AN-TP300)**  
The number of touch pen may differ depending on the model.(See p.40)

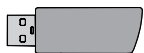

**Touch Pen Dongle  
(AN-TD200)**(See p.40)



**Cradle**(See p.40)

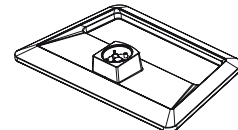

**Stand Base** (See p.12)



**Stand Body** (See p.12)

**NOTE**

- The items supplied with your product may vary depending on the model.
- Product specifications or contents of this manual may be changed without prior notice due to upgrade of product functions.

**How to use the ferrite core**

1 Use the ferrite core to reduce the electromagnetic interference in the PC audio cable. Wind the PC audio cable on the ferrite core thrice. Place the ferrite core close to the TV.

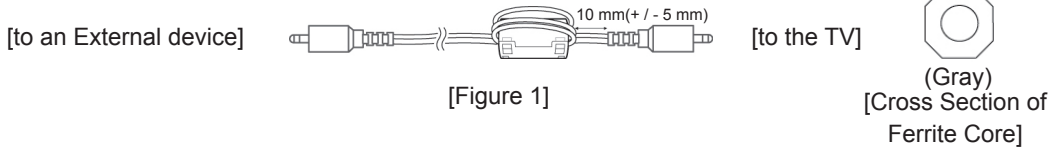

2 Use the ferrite core to reduce the electromagnetic interference in the power cable. Wind the power cable on the ferrite core once. Place the ferrite core close to the TV and a wall plug.

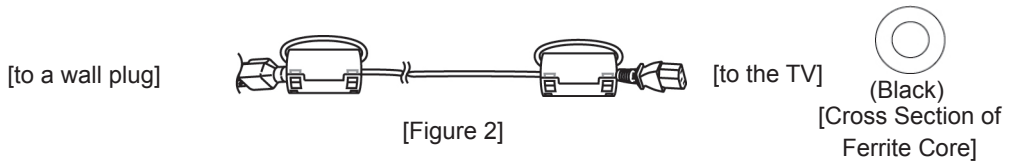

3 Use the ferrite core to reduce the electromagnetic interference in the component Y, Pb, Pr, L, R cable. Wind the component Y, Pb, Pr, L, R cable on the ferrite core once. Place the ferrite core close to the TV.

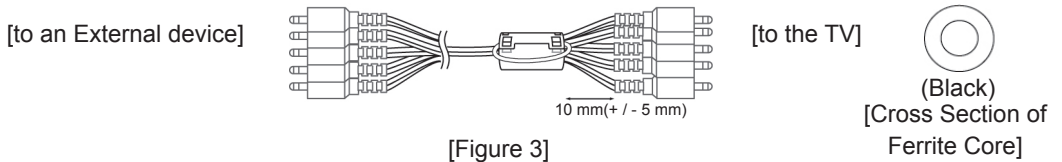

4 Use the ferrite core to reduce the electromagnetic interference in the LAN cable. Wind the LAN cable thrice on the ferrite core. Place the ferrite core close to the TV and an External device.

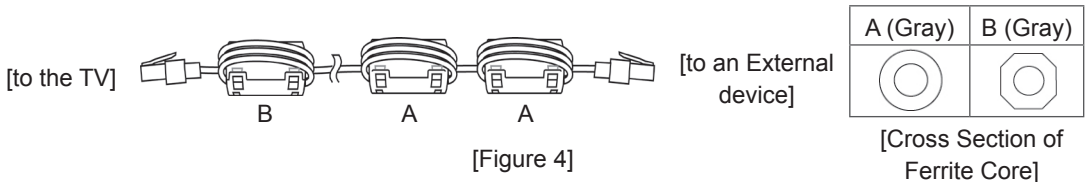

5 Use the ferrite core to reduce the electromagnetic interference in the charging cable. Wind the charging cable on the ferrite core once. Place the ferrite core close to an external device and the cradle or touch pen.

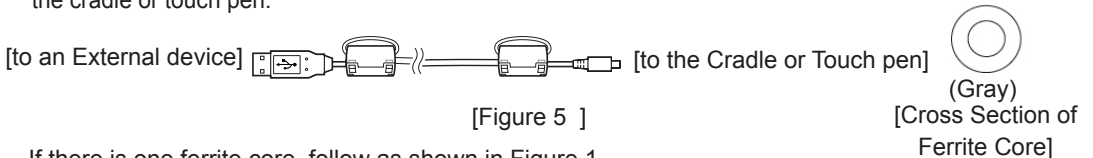

- If there is one ferrite core, follow as shown in Figure 1.
- If there are three ferrite cores, follow as shown in Figures 1 and 2.
- If there are four ferrite cores, follow as shown in Figures 1, 2 and 3.
- If there is LAN port, additionally follow as shown in Figure 4.
- If there is charging cable, additionally follow as shown in Figure 5.

- For an optimal connection, HDMI cables and USB devices should have bezels less than 10 mm thick and 18 mm width. Use an extension cable that supports USB 2.0 if the USB cable or USB memory stick does not fit into your TV's USB port.

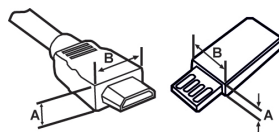

\*A ≧ 10 mm  
\*B ≧ 18 mm

**CAUTION**

- Do not use any pirated items to ensure the safety and product life span.
- Any damages or injuries by using pirated items are not covered by the warranty.

## Separate purchase

Separate purchase items can be changed or modified for quality improvement without any notification. Contact your dealer for buying these items.

This device only works with compatible LG Plasma TV.

**AN-TP300**

Touch Pen, Cradle

The number of touch pen and cradle may differ depending on the model.

Compatibility	42/50PA45**	50/60PA55**	50/60PA65**	42/50PA49**
<b>AN-TP300</b> Touch Pen, Cradle				•

## Parts and buttons

**NOTE**

- TV can be placed in standby mode in order to reduce the power consumption. And TV should be turned off if it will not be watched for some time, as this will reduce energy consumption.
- The energy consumed during use can be significantly reduced if the level of brightness of the picture is reduced, and this will reduce the overall running cost.

**CAUTION**

- Do not step on the glass stand or subject it to any impact. It may break, causing possible injury from fragments of glass, or the TV may fall.
- Do not drag the TV. The floor or the product may be damaged.
- Some models have a thin film attached on to the screen and this must not be removed.

Only 42/50PA45\*\*, 42/50PA49\*\*, 50/60PA55\*\*, 50/60PA65\*\*

- Image shown may differ from your TV.

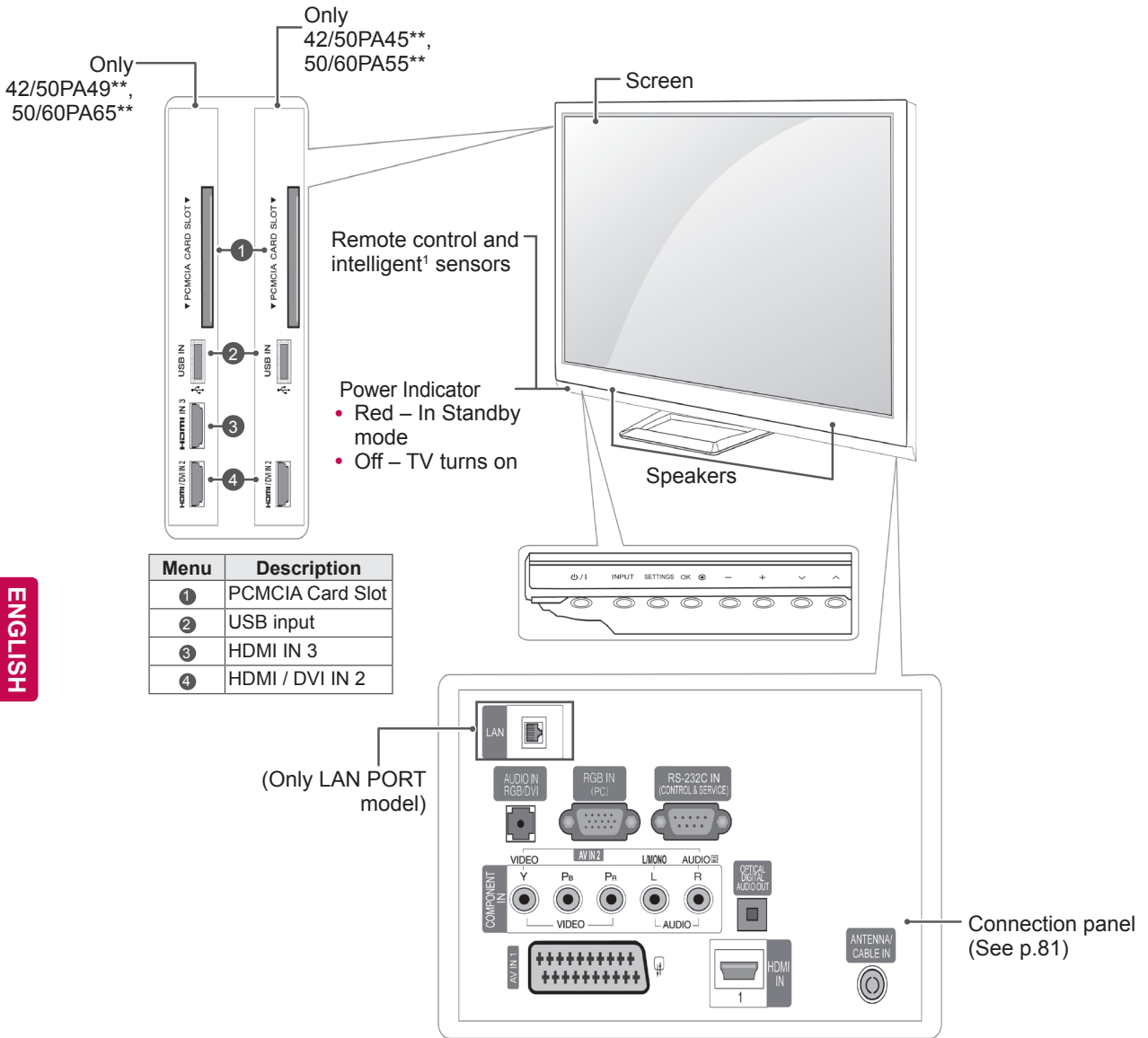

ENGLISH

Button	Description
⏻/⏼	Turns the power on or off
INPUT	Changes the input source
SETTINGS	Accesses the main menus, or saves your input and exits the menus
OK	Selects the highlighted menu option or confirms an input
- +	Adjusts the volume level
∨ ^	Scrolls through the saved programmes

1 Intelligent sensor - Adjusts the image quality corresponding to the surrounding environment.

## Lifting and moving the TV

When moving or lifting the TV, read the following to prevent the TV from being scratched or damaged and for safe transportation regardless of its type and size.



### CAUTION

- Avoid touching the screen at all times, as this may result in damage on the screen or some of the pixels used to create images.

- It is recommended to move the TV in the box or packing material that the TV originally came in.
- Before moving or lifting the TV, disconnect the power cord and all cables.
- When holding the TV, the screen should face away from you to prevent the screen from scratches.

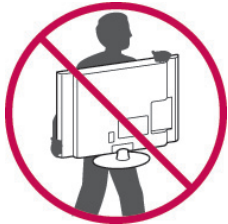

- Hold the top and bottom of the TV frame firmly. Make sure not to hold the transparent part, speaker, or speaker grill area.

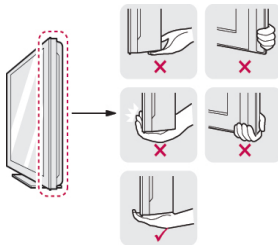

- When transporting a large TV, there should be at least 2 people.
- When transporting the TV by hand, hold the TV as shown in the following illustration.

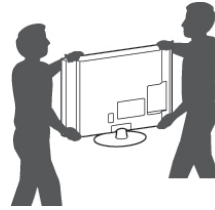

- When transporting the TV, do not expose the TV to jolts or excessive vibration.
- When transporting the TV, keep the TV upright, never turn the TV on its side or tilt towards the left or right.

## Setting up the TV

- Image shown may differ from your TV.

Put your TV on a pedestal stand and mount the TV on a table or wall.

## Attaching the stand

If you are not mounting the TV to a wall, use the following instructions to attach the stand.

Only 42/50PA45\*\*, 42/50PA49\*\*, 50/60PA55\*\*, 50/60PA65\*\*

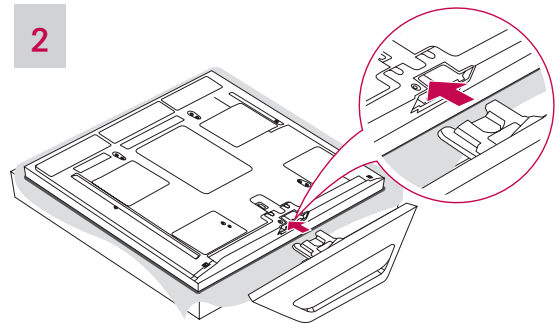
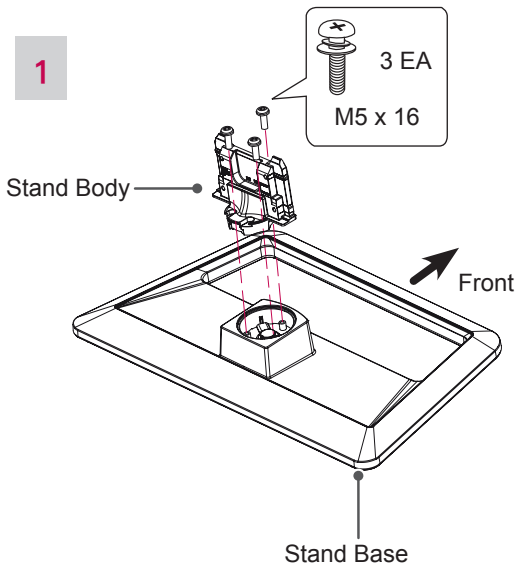

### CAUTION

- When attaching the stand to the TV set, place the screen facing down on a cushioned table or flat surface to protect the screen from scratches.

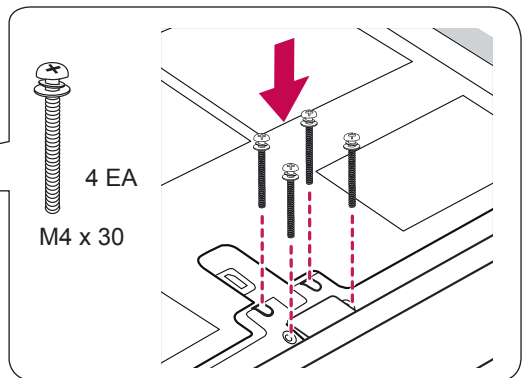
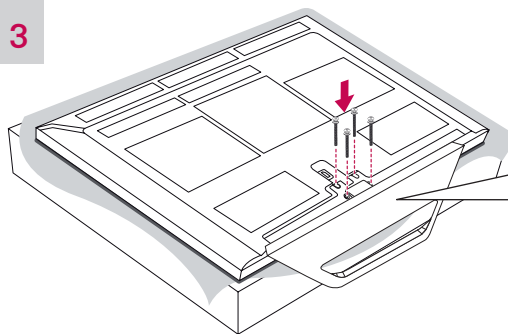

### CAUTION

- Tighten the screws firmly to prevent the TV from tilting forward. Do not over tighten.

To detach the stand,

1

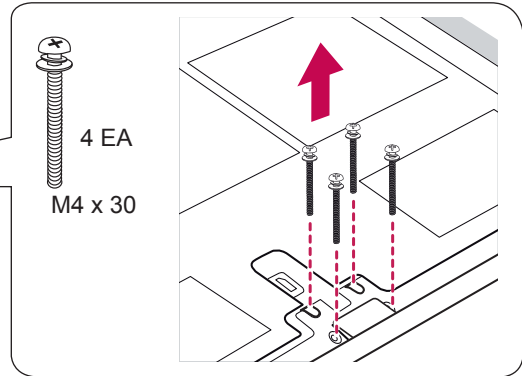
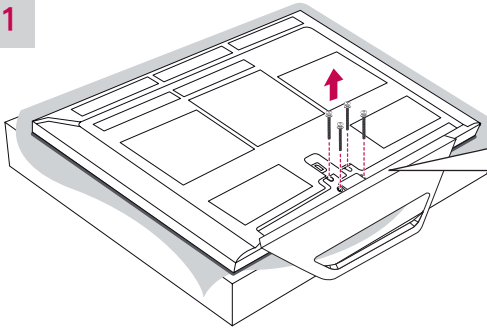

**CAUTION**

- When attaching the stand to the TV set, place the screen facing down on a cushioned table or flat surface to protect the screen from scratches.

2

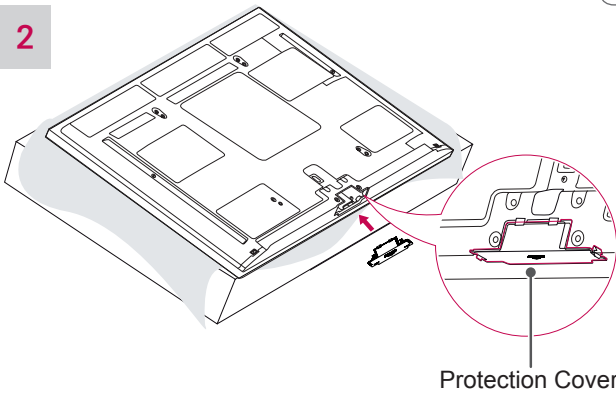

Protection Cover

**NOTE**

- This will protect the opening from accumulating dust and dirt.
- When installing the wall mounting bracket, use the Protection cover.

3

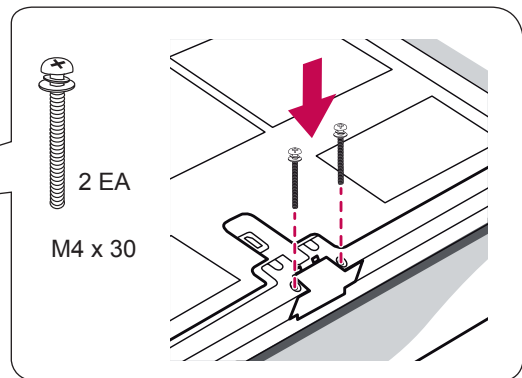
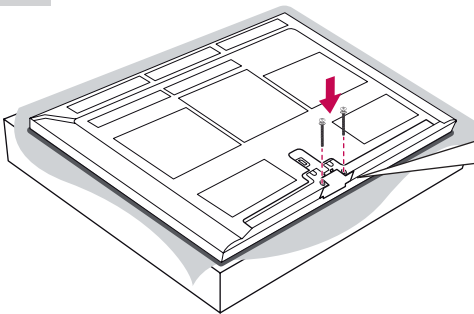

**CAUTION**

- Tighten the screws firmly to prevent the TV from tilting forward. Do not over tighten.

## Mounting on a table

- Image shown may differ from your TV.
- Lift and tilt the TV into its upright position on a table.
    - Leave a 10 cm (minimum) space from the wall for proper ventilation.

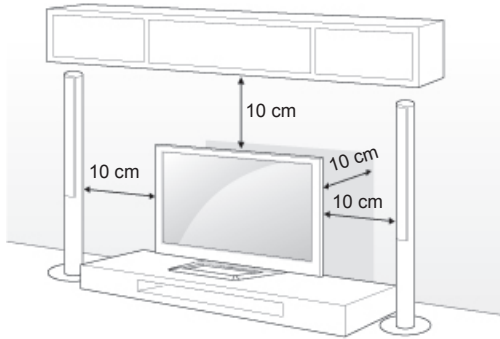

- Connect the power cord to a wall outlet.



### CAUTION

- Do not place the TV near or on sources of heat, as this may result in fire or other damage.



### NOTE

- Swivel 20 degrees to the left or right and adjust the angle of the TV to suit your view.

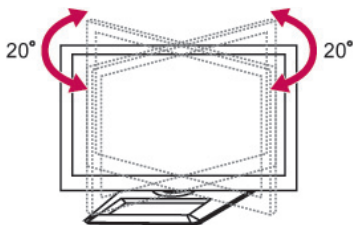

### CAUTION

- When adjusting the angle of the product, watch out for your fingers.

## Securing the TV to a wall (Depending on model)

- Image shown may differ from your TV.

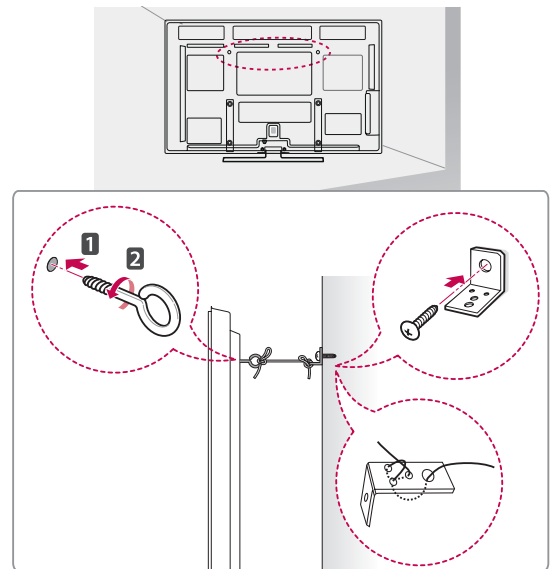

- Insert and tighten the eye-bolts, or TV brackets and bolts on the back of the TV.
  - If there are bolts inserted at the eye-bolts position, remove the bolts first.
- Mount the wall brackets with the bolts to the wall.
  - Match the location of the wall bracket and the eye-bolts on the rear of the TV.
- Connect the eye-bolts and wall brackets tightly with a sturdy rope.
  - Make sure to keep the rope horizontal with the flat surface.



### CAUTION

- Make sure that children do not climb on or hang on the TV.



### NOTE

- Use a platform or cabinet that is strong and large enough to support the TV securely.

## Mounting on a wall

Attach a wall mount bracket at the rear of the TV carefully and install the wall mount bracket on a solid wall perpendicular to the floor. When you attach the TV to other building materials, please contact qualified personnel.

LG recommends that wall mounting be performed by a qualified professional installer.

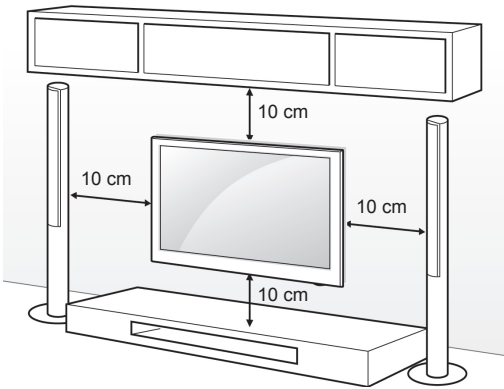

Make sure to use screws and wall mount bracket that meet the VESA standard. Standard dimensions for the wall mount kits are described in the following table.

### Separate purchase(Wall Mounting Bracket)

<b>Model</b>	42/50PA45** 42/50PA49** 50PA55** 50PA65**	60PA55** 60PA65**
<b>VESA (A x B)</b>	400 x 400	600 x 400
<b>Standard screw</b>	M6	M8
<b>Number of screws</b>	4	4
<b>Wall mount bracket</b>	PSW400B, PSW400BG	PSW600B, PSW600BG

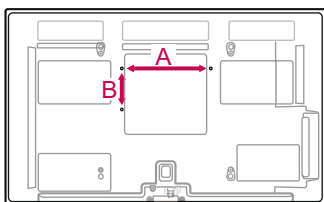
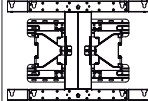
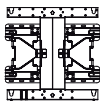

### CAUTION

- Disconnect the power first, and then move or install the TV. Otherwise electric shock may occur.
- If you install the TV on a ceiling or slanted wall, it may fall and result in injury. Use an authorized LG wall mount bracket and contact the local dealer or qualified personnel.
- Do not over tighten the screws as this may cause damage to the TV and void your warranty.
- Use the screws and wall mount bracket that meet the VESA standard. Any damages or injuries by misuse or using an improper accessory are not covered by the warranty.

### NOTE

- Use the screws that are listed on the VESA standard screw specifications.
- The wall mount kit includes an installation manual and necessary parts.
- The length of screws may differ depending on the wall mount. Make sure to use the proper length.
- For more information, refer to the manual supplied with the wall mount bracket.

## Tidying cables

- Image shown may differ from your TV.

- 1 Install the **Power Cord Holder** and **Power Cord**. It will help prevent the power cable from being removed by accident.

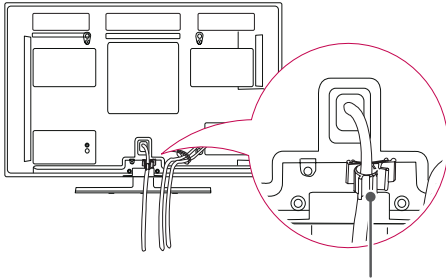

Power Cord Holder

- 2 Gather and bind the cables with the **Cable Holder**.

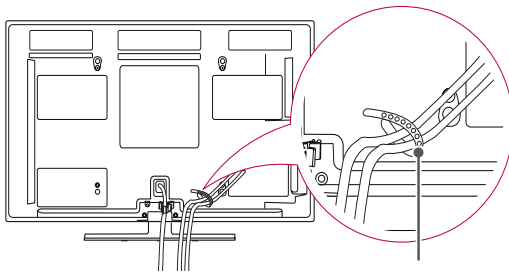

Cable Holder



### CAUTION

- Do not move the TV by holding the **Cable Holder & Power Cord Holder**, as the Cable holders may break, and injuries and damage to the TV may occur.

# REMOTE CONTROL

The descriptions in this manual are based on the buttons on the remote control. Please read this manual carefully and use the TV correctly.

To replace batteries, open the battery cover, replace batteries (1.5 V AAA) matching ⊕ and ⊖ ends to the label inside the compartment, and close the battery cover. Be sure to point the remote control to the remote control sensor on the TV.

To remove the batteries, perform the installation actions in reverse.

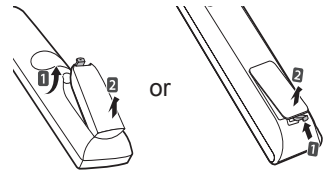

**CAUTION**

- Do not mix old and new batteries, as this may damage the remote control.
- Image shown may differ from your TV.



- ⏻(POWER)**  
Turns the TV on or off.
- ENERGY SAVING** (See p.67)  
Adjusts the brightness of the screen to reduce energy consumption.
- TV/RAD**  
Selects Radio, TV and DTV programme.
- GUIDE**  
Shows programme guide.
- INFO** (See p.28)  
Views the information of the current programme and screen.
- RATIO** (See p.30)  
Resizes an image.
- INPUT** (See p.32)  
Changes the input source; Turns the TV on.
- Number buttons**  
Enters numbers.
- LIST** (See p.27)  
Accesses the saved programme list.
- Q.VIEW**  
Returns to the previously viewed programme.



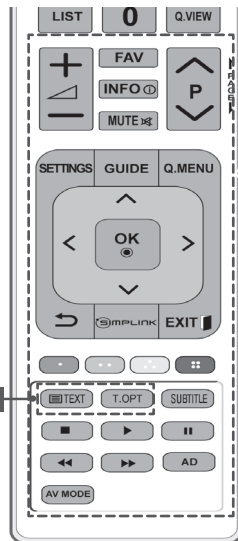
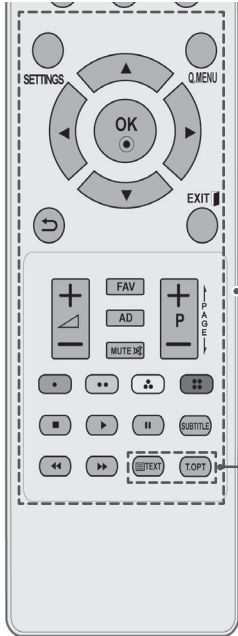

**SETTINGS**

Accesses the main menus, or saves your input and exit the menus.

**Q. MENU** (See p.34)

Accesses the quick menus.

**Navigation buttons** (up/down/left/right)

Scrolls through menus or options.

**OK**

Selects menus or options and confirms your input.



Returns to the previous level.

**EXIT**

Clears all on-screen displays and return to TV viewing.



Adjusts the volume level.

**FAV** (See p.27)

Accesses your favourite programme list.

**AD**

Switches the Audio Description On or Off.

**MUTE**

Mutes all sounds.

**P ^ v** (P + -)

Scrolls through the saved programmes.

**PAGE**

Moves to the previous or next screen.

**Coloured buttons**

These buttons are used for teletext (on TELETEXT models only), Programme edit.

**Control buttons** (■, ►, ||, ◀◀, ▶▶)

Controls the MY MEDIA menus, or the SIMPLINK compatible devices (USB, SIMPLINK).

**SUBTITLE**

Recalls your preferred subtitle in digital mode.

**1 TELETEXT BUTTONS** (See p.93)

These buttons are used for teletext.

For further details, see the 'Teletext' section.

**INFO** (See p.28)

Views the information of the current programme and screen.

**GUIDE**

Shows programme guide.

**SIMPLINK** (See p.92) (Depending on model)

Accesses the AV devices connected with the HDMI cable through HDMI-CEC.

Opens the SIMPLINK menu.

**AV MODE** (See p.32)(Depending on model)

Selects an AV mode

# WATCHING TV

## Connecting an antenna

Connect an antenna to watch TV while referring to the following.

To prevent damage do not connect to the mains outlet until all connections are made between the devices.

Connect the TV to a wall antenna socket with an RF cable (75 Ω).

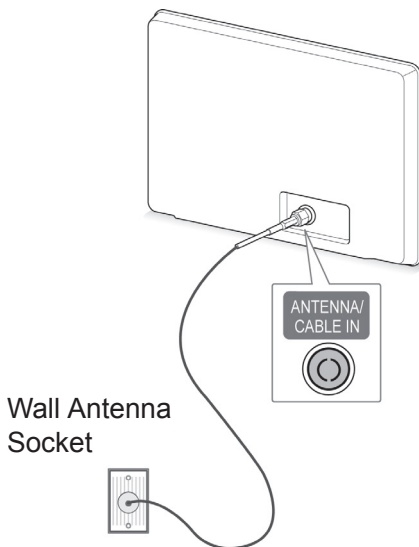

### ! NOTE

- For optimum picture quality, adjust antenna direction.
- In poor signal areas, to achieve better picture quality it may be necessary to install a signal amplifier to the antenna.
- If the image quality is poor with an antenna connected, aim the antenna to the correct direction.
- An antenna cable and converter are not supplied.

## Turning the TV on for the first time

When you turn the TV on for the first time, the Initial setting screen appears. Select a language and customize the basic settings.

- 1 Connect the power cord to a power outlet.
- 2 In Standby mode, press **⏻(POWER)** to turn the TV on.

The Initial setting screen appears if you turn the TV on for the first time.

### ! NOTE

- You can also access **Factory Reset** by accessing **OPTION** in the main menus.

- 3 Follow the on-screen instructions to customize your TV settings according to your preferences.

Language	Selects a language to display.
↓	
Mode Setting	Selects <b>Home Use</b> for the home environment.
↓	
Country	Selects a country to display. (Depending on model)
↓	
Set Password	Set the password. (When France or Italy is selected for Country)
↓	
Time Zone	Selects the time zone and daylight saving. (When Russia is selected for Country)
↓	
Network Setting	(If there is LAN port) selects Network Setting to display.
↓	
Auto Tuning	Scans and saves available programmes automatically.

**NOTE**

- For those countries without confirmed DTV broadcasting standards, some DTV features might not work, depending on the DTV broadcasting environment.
- When France is selected for Country, password is not '0', '0', '0', '0' but '1', '2', '3', '4'.
- To display images in the best quality for your home environment, select Home Use.
- Store Demo is suitable for the retail environment.
- If you select Store Demo, any customized settings will switch back to the default settings of Store Demo in 5 minutes.

- 4 When the basic settings are complete, press **OK**.

**NOTE**

- If you do not complete the Initial setting, it will appear whenever the TV turns on.
- Disconnect the power cord from the power outlet when you do not use the TV for a long period of time.

- 5 To turn the TV off, press **(POWER)**.

## Watching TV

- 1 In Standby mode, press **(POWER)** to turn the TV on.
- 2 Press **INPUT** and select **Antenna**.
- 3 To turn the TV off, press **(POWER)**. The TV switches to Standby mode.

## Managing programmes

### Automatically setting up programme

**Selecting Antenna,**

Use this to automatically find and store all available programmes.

When you start auto programming, all previously stored service information will be deleted.

- 1 Press **SETTINGS** to access the main menus.
- 2 Press the Navigation buttons to scroll to **SETUP** and press **OK**.
- 3 Press the Navigation buttons to scroll to **Auto Tuning** and press **OK**.
- 4 Press the Navigation buttons to scroll to **Antenna** and press **OK**.
- 5 Select **Start** to start automatic tuning. The TV scans and saves available programmes automatically.
- 6 When you are finished, press **EXIT**. When you return to the previous menu, press **↶**.

**NOTE**

- If the TV scans a blocked programme, you will be prompted to enter your password to keep the programme scanned.
- You can store up to 1,800 programmes. The number of programmes that you can store differs depending on the broadcasting signal environment.
- When select **Italy** in the Country menu, if the pop up is displayed when the conflicted programme after Auto Tuning, select a broadcaster for conflicting programme number to solve.
- When select **UK** in the Country menu, if the pop up is displayed when the conflicted programme after Auto Tuning, select a regions, country for conflicting programme number to solve.
- When selected **Norway** in the Country menu, if Network name is recognized more than two after Auto Tuning, you can select your desired one. Programme lists are arranged based on the selected Network name. (Only Nordic models)

## Selecting Cable

- 1 Press **SETTINGS** to access the main menus.
- 2 Press the Navigation buttons to scroll to **SETUP** and press **OK**.
- 3 Press the Navigation buttons to scroll to **Auto Tuning** and press **OK**.
- 4 Press the Navigation buttons to scroll to **Cable** and press **OK**.
- 5 Press the Navigation buttons to scroll to **Major Operator** or **Other Operators** and press **OK**.
- 6 Press the Navigation buttons to scroll to **Quick** or **Full** and press **OK**.
- 7 Press the Navigation buttons or Number buttons to scroll make appropriate adjustments (Except for Full mode) and press **OK**.
- 8 Select **Start** to start automatic tuning. The TV scans and saves available programmes automatically.
- 9 When you are finished, press **EXIT**. When you return to the previous menu, press .

### NOTE

- If the TV scans a blocked programme, you will be prompted to enter your password to keep the programme scanned.
- When you select the **Cable**, the **Cable Service Operator** selection screen can differ or not exist by the Cable situation of the applicable country.
- The popup window to select **Service Operator** is only shown initially for the 3 cases when you accessing the **Initial Setting** menu, when you change from **Antenna** to **Cable** or when you access the menu after changing the **Country**.
- When you want to select Service Operator aside from the above 3 cases, you can do so by selecting **Setup->Cable DTV Setting->Service Operator**.

- Acquired certification SO : Sweden(Comhem, Canal Digital), Denmark(YouSee, Canal Digital, Stofa), Norway(Canal Digital), Netherlands(Ziggo, UPC Digtiaal), Ukraine(Volia-Cable), Germany(KDG, Unity Media), Switzerland(CableCom, UPC), Austria(UPC Digital), Hungary(UPC Digital), Ireland(UPC Digital), Poland(UPC Digital), Romania(UPC Digital), Russia(TVOE TV(St.Petersburg),TVOE (Ekaterinburg),Dom.ru,AKADO, OnLime) (The acquired certification SO can be added.)
- If there are not any Service Operator that you want, select **Other Operators**.
- If you select "**Other Operators**", or the selected country supports "**Other Operators**" only, it may take some time to search all the programmes, or it may not search some of the programmes.
- If some of the programmes do not appear, follow the steps below:
  1. **SETUP -> Auto Tuning -> Cable -> Setting**
  2. Input additional values such as the frequency, symbol rate, modulation, and network ID. (You can ask your cable service provider for the above information.)

The following values are needed in order to search all available programmes quickly and correctly.

The commonly used values are provided as "default".

However, for correct settings, please inquire of the cable service provider.

When running **Auto Tuning** in DVB cable mode, selecting Full will search through all frequencies to find available programmes.

In the case when the programme is not searched by selecting the Default, perform the searching by selecting the Full.

However, in the case when the programme is searched by selecting the Full, the Auto Tuning time can be taken too much.

If some programmes are not detected when **Full** is selected, select the In detail checkbox and then try tuning again.

- **Frequency** : Enter a user-defined frequency.
- **Symbol rate** : Enter a user-defined symbol rate (Symbol rate: Speed at which a device such as modem sends symbols to a channel).
- **Modulation** : Enter a user-defined modulation. (Modulation: Loading of audio or video signals onto carrier).
- **Network ID** : Unique identifier allocated for each user.
- **Start Frequency** : Enter a user-defined start frequency range.
- **End Frequency** : Enter a user-defined end frequency range.

## Cable DTV Setting (In Cable mode only)

The range that a user can select from the Service Operator menu differs depending on number of Service Operator supported by each country, and if number of supported Service Operator for each country is 1, corresponding function becomes non-activation.

- 1 Press **SETTINGS** to access the main menus.
- 2 Press the Navigation buttons to scroll to **SETUP** and press **OK**.
- 3 Press the Navigation buttons to scroll to **Cable DTV Setting** and press **OK**.
- 4 Press the Navigation buttons to scroll to **Service Operator** or **Channel Auto update** and press **OK**.
- 5 Select your desired Source.
- 6 When you are finished, press **EXIT**.  
When you return to the previous menu, press ↩.

- If you select **Cable**, you can see **Cable DTV Setting** menu.
- When **Channel Auto Update** is **On**, you can update information for all the programmes that can be updated, including the programme currently being watched.
- When **Channel Auto Update** is **Off**, you can only update information for the programme currently being watched.
- You can not select the **Cable DTV Setting** when the service operator is set to "Ziggo".

## Manually setting up programme (In digital mode)

Manual Tuning lets you manually add a programme to your programme list.

### Selecting Antenna,

- 1 Press **SETTINGS** to access the main menus.
- 2 Press the Navigation buttons to scroll to **SETUP** and press **OK**.
- 3 Press the Navigation buttons to scroll to **Manual Tuning** and press **OK**.
- 4 Press the Navigation buttons to scroll to **DTV** and press **OK**.
- 5 Scroll through the programme types, and then add or delete programmes.
- 6 When you are finished, press **EXIT**.  
When you return to the previous menu, press ↩.

### NOTE

- If the TV scans a blocked programme, you will be prompted to enter your password to keep the programme scanned.
- You can select **SBAND** when the country is set to "Norway, Latvia."

### Selecting Cable,

- 1 Press **SETTINGS** to access the main menus.
- 2 Press the Navigation buttons to scroll to **SETUP** and press **OK**.
- 3 Press the Navigation buttons to scroll to **Manual Tuning** and press **OK**.
- 4 Press the Navigation buttons to scroll to **Cable DTV** and press **OK**.
- 5 Make appropriate adjustments.
- 6 When you are finished, press **EXIT**.  
When you return to the previous menu, press ↩.

### NOTE

- If the TV scans a blocked programme, you will be prompted to enter your password to keep the programme scanned.
- **Symbol rate** : Enter a user-defined symbol rate (Symbol rate: Speed at which a device such as modem sends symbols to a channel).
- **Modulation** : Enter a user-defined modulation. (Modulation: Loading of audio or video signals onto carrier).
- You can not select the **Cable DTV** when the service operator is set to "Ziggo" or "Other Operators" of Netherlands.

## Manually setting up programme (In analogue mode)

Manual Tuning lets you manually tune and arrange the stations in whatever order you desire.

- 1 Press **SETTINGS** to access the main menus.
- 2 Press the Navigation buttons to scroll to **SETUP** and press **OK**.
- 3 Press the Navigation buttons to scroll to **Manual Tuning** and press **OK**.
- 4 Press the Navigation buttons to scroll to **TV** or **Cable TV** and press **OK**.
- 5 Scroll through the programme types, and then add or delete programmes.
- 6 Press the Navigation buttons to scroll to TV System.
- 7 Press the Navigation buttons to scroll to **V/UHF** or **Cable**.
- 8 Press the Navigation buttons or Number buttons to scroll to the desired channel number.
- 9 Press the Navigation buttons to scroll to commence searching.
- 10 Press the Navigation buttons to scroll to **Store** and press **OK**.
- 11 When you are finished, press **EXIT**.  
When you return to the previous menu, press .

### NOTE

- If the TV scans a blocked programme, you will be prompted to enter your password to keep the programme scanned.
- **L** : SECAM L/L' (France)
- **BG** : PAL B/G, SECAM B/G (Europe / East Europe / Asia / New Zealand / M.East / Africa)
- **I** : PAL I (U.K. / Ireland / Hong Kong / South Africa)
- **DK** : PAL D/K, SECAM D/K (East Europe / China / Africa / CIS)
- To store another channel, repeat steps 5 to 10.

### Assigning a station name

You can assign a station name with five characters to each programme number.

- 1 Press **SETTINGS** to access the main menus.
- 2 Press the Navigation buttons to scroll to **SETUP** and press **OK**.
- 3 Press the Navigation buttons to scroll to **Manual Tuning** and press **OK**.
- 4 Press the Navigation buttons to scroll to **TV** or **Cable TV**.
- 5 Press the Navigation buttons to scroll to **Name** and press **OK**.
- 6 Press the Navigation buttons to scroll Select the position and make your choice of the second character, and so on. You can use an the alphabet A to Z, the number 0 to 9, +/ -, and blank and press **OK**.
- 7 Press the Navigation buttons to scroll to **Close** and press **OK**.
- 8 Press the Navigation buttons to scroll to **Store** and press **OK**.
- 9 When you are finished, press **EXIT**.  
When you return to the previous menu, press .

## Editing your programme list

When a programme number is skipped, it means that you will be unable to select it using **P**  $\wedge$   $\vee$  (**P** + **-**) button during TV viewing.

If you wish to select the skipped programme, directly enter the programme number with the **NUMBER** buttons or select it in the Programme edit menu.

This function enables you to skip the stored programmes.

You can change the programme number using "Move" function, if "Automatic Numbering" is unchecked when you start Auto Tuning.

- 1 Press **SETTINGS** to access the main menus.
- 2 Press the Navigation buttons to scroll to **SETUP** and press **OK**.
- 3 Press the Navigation buttons to scroll to **Programme Edit** and press **OK**.
- 4 Press the Navigation buttons to select a programme to be stored or skipped.
- 5 When you are finished, press **EXIT**.  
When you return to the previous menu, press  $\curvearrowright$ .

In DTV/RADIO mode

### Skipping a programme number

- 1 Press the Navigation buttons to scroll to select a programme number to be skipped.
- 2 Press Blue button to turn the programme number.
- 3 Press Blue button to release.

#### NOTE

- When programmes are to be skipped, the skipped programme shows in blue and these programmes will not be selected by the **P**  $\wedge$  (**P** +) or **P**  $\vee$  (**P** -) buttons during TV viewing.
- If you wish to select a skipped programme, directly enter the programme number with the **NUMBER** buttons or select it in the programme edit or EPG.

### Locking a programme number

- 1 Press the Navigation buttons to scroll to select a programme number to be locked.
- 2 Press Yellow button to turn the programme number.
- 3 Press Yellow button to release.

#### NOTE

- It can be registered as Lock programme even when **Lock System** is turned **Off**.

### Editing a programme number

- 1 Press the Navigation buttons to scroll to select a programme number to be edited.
- 2 Press Green button to turn the programme number.
- 3 Press the Navigation buttons to scroll to select your desired programme number.
- 4 Press Yellow button to release.

#### In TV mode

### Deleting a programme

- 1 Press the Navigation buttons to scroll to select a programme number to be deleted.
- 2 Press Red button to turn the programme number.

#### NOTE

- The selected programme is deleted, all the following programmes are shifted up one.

### Moving a programme

- 1 Press the Navigation buttons to scroll to select a programme number to be moved.
- 2 Press the Green button to turn the programme number and press the Navigation buttons.
- 3 Press Green button to release.

### Skipping a programme number

- 1 Press the Navigation buttons to scroll to select a programme number to be skipped.
- 2 Press Blue button to turn the programme number.
- 3 Press Blue button to release.

#### NOTE

- When programmes are to be skipped, the skipped programme shows in blue and these programmes will not be selected by the **P**  $\wedge$  **V** (**P** + **-**) buttons during TV viewing.
- If you wish to select a skipped programme, directly enter the programme number with the **NUMBER** buttons or select it in the programme edit.

## Auto Sort

- 1 Press the Navigation buttons to start Auto Sort and press **OK**.



### NOTE

- After activating Auto Sort once, you can no longer edit programmes.

## Locking a programme number

- 1 Press the Navigation buttons to scroll to select a programme number to be locked.
- 2 Press Yellow button to turn the programme number.
- 3 Press Yellow button to release.



### NOTE

- It can be registered as Lock programme even when **Lock System** is turned **Off**.

## Selecting favourite programme

- 1 Press the Navigation buttons to scroll to select your desired programme.
- 2 Press the **FAV** to add corresponding programme to Favourite list of current Favourite group.
- 3 Press **FAV** to release.

## Selecting favourite programme group

- 1 Press the Navigation buttons to scroll to select your desired programme.
- 2 Press the **Q.MENU** to display a pop-up window where Favourite group can be changed.
- 3 Press the Navigation buttons to scroll to select a Favourite group and press **OK**.

## CI [Common interface] Information

- This feature is not available in all countries.

This function enables you to watch some encrypted services (pay services). If you remove the CI Module, you cannot watch pay services.

When the module is inserted into the CI slot, you can access the module menu.

To purchase a module and smart card, contact your dealer. Do not repeatedly insert or remove a CI module from the TV. This may cause a malfunction. When the TV is turned on after inserting a CI Module, you may not have any sound output.

This may be incompatible with the CI module and smart card.

CI (Common Interface) functions may not be possible depending upon the country broadcasting circumstances.

When using a CAM(Conditional Access Module), please make sure it meets fully the requirements of either DVB-CI or CI plus.

- 1 Press **SETTINGS** to access the main menus.
- 2 Press the Navigation buttons to scroll to **SETUP** and press **OK**.
- 3 Press the Navigation buttons to scroll to **CI Information** and press **OK**.
- 4 Select the desired item: Module information, smart card information, language, or software download etc and press **OK**.
- 5 When you are finished, press **EXIT**.



### NOTE

- This OSD is only for illustration and the menu options and screen format will vary according to the Digital pay services provider.
- It is possible for you to change CI (Common Interface) menu screen and service by consulting your dealer.

## Selecting the programme list

You can check which programmes are stored in the memory by displaying the programme list.

### Displaying programme LIST

- 1 Press **LIST** to access the Programme List.
- 2 Press Blue button to turn the programme edit.

#### NOTE

- You may find some blue programmes. These have been set up to be skipped by auto programming or in the programme edit mode.
- Some programmes with the channel number shown in the programme LIST indicate there is no station name assigned.

### Selecting a programme in the programme list

- 1 Press Navigation buttons to select programme.
- 2 Press **OK** to switch to the chosen programme number.

#### NOTE

- Press **TV/RAD.** (The mode will be switched between TV, DTV, and Radio from the programme you are currently watching.)

### Paging through a programme list

- 1 Press the **P ^ v** (P + -) buttons to turn the pages.
- 2 Press **LIST** to return normal TV viewing.

### Displaying the favourite programme list

- 1 Press **FAV** to access the Favourite Programme List.
- 2 When you are finished, press **EXIT**.

Button	Description
Blue button	Turn the programme edit.
Yellow button	Current channel is registered/ cancelled as preferred channel on currently selected Group.
<b>OK</b>	Selects a programme to view
< or >	Favourite group is changed.

## EPG (Electronic Programme Guide) (In digital mode)

This system has an Electronic Programme Guide (EPG) to help your navigation through all the possible viewing options.

The EPG supplies information such as programme listings, start and end times for all available services. In addition, detailed information about the programme is often available in the EPG (the availability and amount of these programme details will vary, depending on the particular broadcaster).

This function can be used only when the EPG information is broadcast by broadcasting companies. You must set the Clock in the **Time** menu, before using EPG function.

The EPG displays the programme details for 8 days.



- Press **INFO** to show current programme information.

	Displayed with a TV or DTV Programme.
	Displayed with a Radio Programme.
	Displayed with a MHEG Programme.
	Displayed with a HE-AAC Programme.
	Aspect ratio of broadcasting programme.
	Aspect ratio of broadcasting programme.
	Displayed with a Teletext Programme.
	Displayed with a Subtitle Programme.
	Displayed with a Scramble Programme.
	Displayed with a Dolby Digital Programme.
	Displayed with a Dolby Digital Plus Programme.
576i/p, 720p, 1080i/p : Resolution of broadcasting programme	
	Broadcasted programme with the icon may not be displayed in Monitor Out depending on the information of the programme.

>	Shows next programme information.
∨ or ^	Shows other programme information.

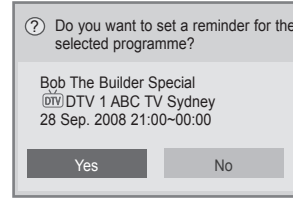

<b>OK</b>	A pop-up window for remind settings appear.
< >	Select Timer Remind setting mode.

## Switch on/off EPG

- 1 Press **GUIDE** to switch on or off EPG.

## Select a programme (NOW / NEXT Guide Mode)

- 1 Press Navigation buttons or **P ^ ∨ (P + -)** to select desired programme.

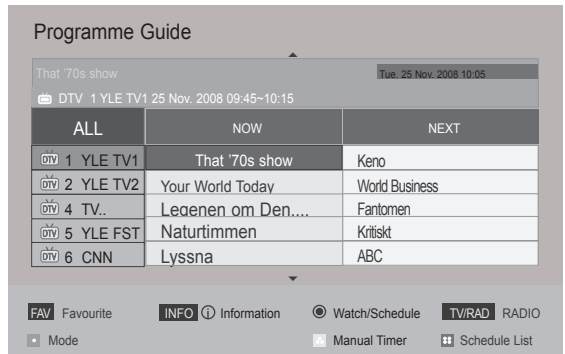

## NOW/NEXT Guide Mode

You can view a programme being broadcasted and one scheduled to follow.

Button	Description
Red button	Change EPG mode.
Yellow button	Enter Manual Timer mode.
Blue button	Enter Schedule List mode.
<b>OK</b>	When 'Now' is selected, it is moved to selected programme and EPG disappears When 'Next' is selected, a reservation pop-up window appears.
< >	Select NOW or NEXT Programme.
^ v	Select the Broadcast Programme.
P ^ v (P + -)	Page Up/Down.
<b>GUIDE</b>	Switch off EPG.
↶	
<b>EXIT</b>	
<b>TV/RAD</b>	Select DTV or RADIO Programme.
<b>INFO</b>	Detail information on or off.

## 8 Day Guide Mode

Button	Description
Red button	Change EPG mode.
Green button	Enter Date setting mode.
Yellow button	Enter Manual Timer mode.
Blue button	Enter Schedule List mode.
<b>OK</b>	When 'Currently broadcasting programme' is selected, it is moved to selected programme and EPG disappears When 'Future broadcasting programme' is selected, a reservation pop-up window appears.
< >	Select Programme.
^ v	Select the Broadcast Programme.
P ^ v (P + -)	Page Up/Down.
<b>GUIDE</b>	Switch off EPG.
↶	
<b>EXIT</b>	
<b>TV/RAD</b>	Select DTV or RADIO Programme.
<b>INFO</b>	Detail information on or off.

## Date Change Mode

Button	Description
Green button	Switch off Date setting mode.
v	
↶	Change to the selected date.
<b>OK</b>	
< >	Select a date.
<b>GUIDE</b>	Switch off EPG.
<b>EXIT</b>	

## Extended Description Box

Button	Description
<b>INFO</b>	The detail information on or off.
^ v	Text Up/Down.
<b>GUIDE</b>	Switch off EPG.
<b>EXIT</b>	

## Remind Setting Mode

Button	Description
↶	Switch off Manual Timer mode.
<b>OK</b>	Save Timer Remind.
< >	Select Start Time or Programme.
^ v	Select Remind function setting.

## Schedule List Mode

If you've created a schedule list, a scheduled programme is displayed at the scheduled time even when you are watching a different programme at the time.

Button	Description
Yellow button	Change to Manual Timer mode.
Blue button	Change to Guide mode.
<b>GUIDE</b>	
<b>OK</b>	Select your desired Option (Modify/Delete/Delete All).
^ v	Select programme.
P ^ v (P + -)	Page Up/Down.
↶	Switch off Schedule List.

- **16:9:** Resizes images to fit the screen width.

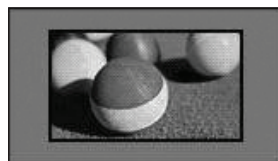

- **Just Scan:** Displays video images in the original size without removing parts at the edge of the image.

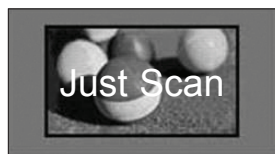

## Using additional options

### Adjusting aspect ratio

Resize an image to view at its optimal size by pressing **RATIO** while you are watching TV.

#### ! NOTE

- You can also change the image size by pressing **Q. MENU** or accessing **Aspect Ratio** in the Picture menus.
- For Zoom Setting, select **14:9** and **Cinema Zoom** in Ratio Menu. After completing Zoom Setting, the display goes back to Q.Menu.
- You can only select **4:3**, **16:9** (Wide), **14:9**, **Cinema Zoom** in Component mode.
- You can only select **4:3**, Original, **16:9** (Wide), **14:9**, **Cinema Zoom** in HDMI mode.
- You can only select **4:3**, **16:9** (Wide) in RGB-PC, HDMI-PC mode only.
- In DTV/HDMI/Component (over 720p) mode, **Just Scan** is available.
- In Analogue/DTV/AV/Scart mode, **Full Wide** is available.

#### ! NOTE

- If you select **Just Scan**, you may see image noises at the edge of the original signal.

- **Original:** When your TV receives a wide screen signal it will automatically change to the picture format broadcasted.



- **Full Wide:** When TV receives the wide screen signal, it will let you adjust the picture horizontally or vertically, in a linear proportion, to fill the entire screen fully.

4:3 and 14:9 video is supported in full screen without any video distortion through DTV input.



- **Cinema Zoom:** Enlarges an image in the cinema scope ratio, 2.35:1.
  - To change the ratio of the cinema zoom, press the Navigation buttons and its range is from 1 to 16.
  - To move the zoom focus up or down, press the Navigation buttons.

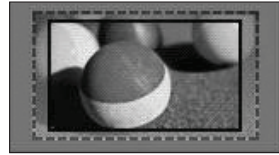

**! NOTE**

- If you enlarge or reduce an image, the image may be distorted.

- **4:3:** Resizes images to the previous standard 4:3.



- **14:9:** You can view a picture format of 14:9 or a general TV programme in the 14:9 mode. The 14:9 screen is viewed in the same way as in 4:3, but is moved to the up and down.



## Changing AV modes

(Depending on model)

Each AV mode has the optimized image and sound settings.

Press **AV MODE** repeatedly to select an appropriate mode.

Mode	Description
<b>Off</b>	Changes to the previously customized settings
<b>Cinema</b>	Use the optimized image and sound settings for the cinematic look
<b>Game</b>	Use the optimized image and sound settings for fast gaming When playing a video game using PlayStation or Xbox, it is recommended to use the <b>Game</b> mode. When in <b>Game</b> mode, functions related to picture quality will be optimized for playing games.

### NOTE

- If you select **Off** in AV mode, the picture and image which you initially set will be selected.

## Using the input list

### Selecting an input source

- 1 Press **INPUT** to access the input sources.
  - The connected device displays on each input source.

### NOTE

- You can also access the input source list by selecting **INPUT** in the main menus.

- 2 Press Navigation buttons to scroll to one of the input sources and press **OK**.

- Image shown may differ from your TV.

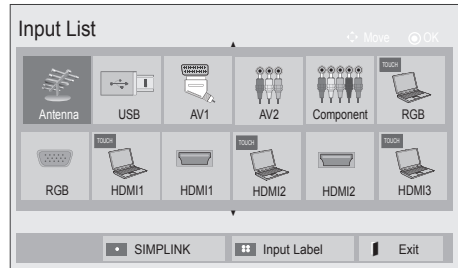

Input source	Description
<b>Antenna or Cable</b>	Select it when watching the DTV/RADIO/TV.
<b>USB</b>	Select it when using USB depends on connector.
<b>AV</b>	Select it when watching the VCR or external equipment.
<b>Component</b>	Select it when using the DVD or the Digital set-top box depends on connector.
<b>RGB (TOUCH)</b>	Select it when using PC depends on connector.(For Pentouch TV)
<b>RGB</b>	Select it when using PC depends on connector.
<b>HDMI (TOUCH)</b>	Select it when using DVD, PC or Digital set-top box depend on connector. (For Pentouch TV)
<b>HDMI</b>	Select it when using DVD, PC or Digital set-top box depend on connector.

The connected input sources display in black and the disconnected input sources in grey.

- To add an input label, press the Blue button. You can easily identify a device connected to each input source.

### Adding an Input label

Add a label to an input source so that you can easily identify a device connected to each input source.

- Image shown may differ from your TV.

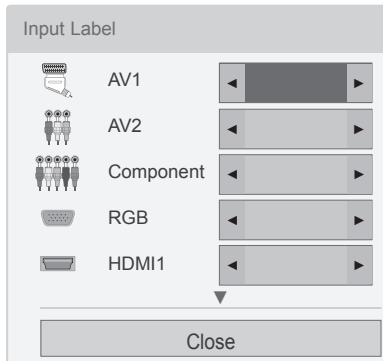

- 1 Press **INPUT** to access the input sources.
- 2 Press the **Blue** button.
- 3 Press the Navigation buttons to scroll to one of the input sources.
- 4 Press the Navigation buttons to scroll to one of the input labels.
- 5 When you are finished, press **EXIT**.  
When you return to the previous menu, press ↩.

### ! NOTE

- This function is not supported in Pentouch mode.

## Locking the buttons on the TV (Child Lock)

Lock the buttons on the TV to prevent any unwanted operations or accidents by children.

- 1 Press **SETTINGS** to access the main menus.
- 2 Press the Navigation buttons to scroll to **LOCK** and press **OK**.
- 3 Press Navigation buttons to scroll to **Key Lock** and press **OK**.
- 4 Select **On** to activate the Key lock feature.  
- To deactivate the Key lock feature, select **Off**.
- 5 When you are finished, press **EXIT**.

When you return to the previous menu, press ↩.

### ! NOTE

- The TV is programmed to remember the last setting after you turn the TV off.
- If you turn the TV off with the **Key Lock** feature activated, press the **⏻**, **INPUT**, **P** ^ **∇** (P + -) or Number buttons on the remote control.
- If you press any button on the TV with the Key lock feature activated, **! Key Lock** appears on the screen.

## Using the quick menu

Customize the frequently used menus.

- 1 Press **Q. MENU** to access the quick menus.
- 2 Press Navigation buttons to scroll through the following menus and press **OK**.

- Image shown may differ from your TV.

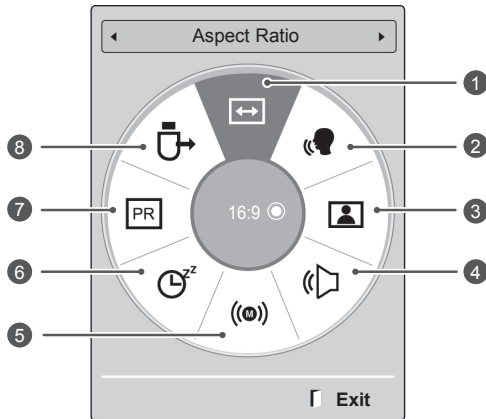

### ! NOTE

- The available menus and options may differ from the input source that you are using.

- 3 Press Navigation buttons to scroll to the option you want.
- 4 When you are finished, press **Q. MENU**.

Menu	Description
1 <b>Aspect Ratio</b>	Changes the image size (16:9, Just Scan, Original, Full Wide, 4:3, 14:9, Cinema Zoom)
2 <b>Clear Voice II</b>	By differentiating the human sound range from others, it helps users listen to human voices better.
3 <b>Picture Mode (Depending on model)</b>	Changes the image mode (Vivid, Standard, APS, Cinema, Game, Expert1, Expert2)
4 <b>Sound Mode</b>	Changes the sound mode (Standard, Music, Cinema, Sport, Game)
5 <b>Audio or Audio Language</b>	Changes the sound output.
6 <b>Sleep Timer</b>	Sets the length of time until the TV to turns off
7 <b>Skip Off/On</b>	Sets the Skip Off/On.
8 <b>USB Device</b>	Ejects a USB device when a USB device is connected

## Using the customer support

### Testing Software Update

To download software through the digital terrestrial broadcasting system.

- 1 Press **SETTINGS** to access the main menus.
- 2 Press the Red button to scroll **Customer Support**.
- 3 Press the Navigation buttons to scroll **Software Update**.
- 4 Press the Navigation buttons to scroll to **On** and press **OK**.
  - If you select **On**, a user confirm message box will be displayed to notify that new software is found.
- 5 When you are finished, press **EXIT**.  
When you return to the previous menu, press **↶**.

#### When setting “Software Update”

- Occasionally, a transmission of updated digital software information will result in the following menu on the TV screen.

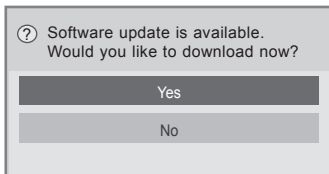

- Simple Update : for current update stream

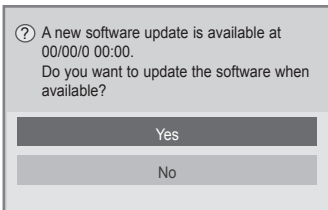

- Schedule Update : for scheduled update stream
- When the Software Update menu is “Off”, the message to change it to “On” appears.

- Download starts when “Yes” is selected. At this time, progressing pop-up window does not display.
- Download progress status can be checked from Software Update menu.

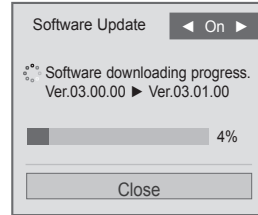

- TV is restarted when download is completed.

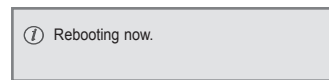

#### NOTE

- During Progress of a **Software Update**, please note the following:
  - Power to the TV must not be interrupted.
  - The antenna must not be disconnected.
- After **Software Update**, you can confirm the updated software version in Software Update menu.
- It may take hours to download the software, so make sure that the power stays on during the download.
- The software is downloaded only in Standby mode or in MUX with Software Update Service, and stops when the power cord is unplugged or when viewing MUX without Software Update Service.
- When you return to Standby mode or MUX with Software Update Service, the software download will resume from where it stopped.

## Testing the Picture / Sound

To execute picture and sound tests.

- 1 Press **SETTINGS** to access the main menus.
- 2 Press the Red button to scroll **Customer Support**.
- 3 Press the Navigation buttons to scroll **Picture Test** or **Sound Test**.
- 4 Press the Navigation buttons to scroll to **Yes** and press **OK**.
- 5 When you are finished, press **EXIT**.  
When you return to the previous menu, press ↩.

## Using the product or service information

To check the product or service information

- 1 Press **SETTINGS** to access the main menus.
- 2 Press the Red button to scroll **Customer Support**.
- 3 Press the Navigation buttons to scroll **Product/Service Info..**  
You can check the various product/Service information based on your model.
- 4 When you are finished, press **EXIT**.  
When you return to the previous menu, press ↩.

## Using Signal Test

To view information on the Manufacturer, Model/Type, Serial Number and Software Version.

- 1 Press **SETTINGS** to access the main menus.
- 2 Press the Red button to scroll **Customer Support**.
- 3 Press the Navigation buttons to scroll **Signal Test**.
- 4 Press **OK**.  
- Manufacturer, Model/Type, Serial Number, Software Version and information of Channel.
- 5 When you are finished, press **EXIT**.  
When you return to the previous menu, press ↩.



### NOTE

- This displays the information and signal strength of the tuned \*MUX.
- This displays the signal information and service name of the selected MUX.  
(\*MUX: A higher directory of channels in digital broadcasting (a single MUX contains multiple channels.))

# PENTOUCH

(Only PENTOUCH TV)

## Using Pentouch

Pentouch allows you to use touch pen supported features like Sketchbook, Photo Editor, Family Diary, Gallery, Internet and My Office.



### WARNING

- Do not drop or throw the touch pen and cradle. Do not swing the touch pen and cradle with the charging cable connected to it. This can damage the product or cause personal injury.
- For people using pacemakers, the distance between the touch pen and the pacemaker should be at least 30 cm. Never use it where wireless communication is prohibited. Protect it from extreme vibrations or magnetic objects. Wireless communications can cause malfunctions or failures.
- Do not use or store the touch pen and cradle in direct sunlight, near a hot object (e.g., a heater or fireplace), or in dusty or high-humidity environments. This can result in product deformation, malfunction, failure, or fire.
- If abnormal sound, smoke, or odor is detected, immediately remove the charging cable and stop using the product. Contact a service center. This can cause failures or fire.
- If fluid leaks from the touch pen and cradle, do not touch the fluid with bare hands. If fluid comes into contact with eyes, immediately rinse eyes with abundant tap water, then consult a doctor. The fluid can cause blindness. If the fluid comes into contact with skin or clothing, immediately wash it off with tap water. If the fluid causes skin inflammation or injury, consult a doctor.
- Do not allow the fluid to come into contact with fire. Do not heat the product in a microwave or convection oven.
- Use the specified USB cable when charging the battery.
- Keep the touch pen and cradle out of reach of children and away from unstable locations. Do not let children or pets put the touch pen and cradle in their mouths or lick the touch pen and cradle. Playing with or swallowing it may cause serious injury.
- Do not use the touch pen and cradle with wet hands. Do not let foreign substances (e.g., soft drinks or water) enter the touch pen and cradle; if this happens, do not use the touch pen and cradle. Do not touch the optic receiver of the touch pen and cradle with a sharp object. This can result in electrical shock or damage the product.
- Do not use the product under extreme temperature conditions. Do not use the product immediately after going from the cold outdoors to the warm indoors. This can cause condensation in the pen. \* This can result in damaging the product. Turn off the power and wait several hours until the moisture evaporates before using the product.
- Never disassemble or modify the touch pen and cradle. \* The product warranty does not cover damage or injury caused by unauthorized disassembly. This can result in electrical shock or damage the product.
- If fluid leaks from the touch pen and cradle, the use of fire in the vicinity is strictly prohibited. The leaked fluid or gas can ignite a fire or cause damage.
- Avoid extreme shocks or impacts to the product, for example, placing a heavy object on it or pressing it.
- Do not display fixed characters or images on the screen for extended periods of time. This can cause image sticking.
- Do not connect the charging cable to peripheral devices or disks that are not specified. This can cause malfunctions or failures.
- Do not leave the touch pen and cradle on the floor. Stepping on it can damage the product or cause personal injury.
- Be careful when disposing of the product. The touch pen and cradle consists of a lithium-polymer battery and plastic material. Burning can be dangerous, so dispose of it according to local regulations.
- Do not remove the charging cable using excessive force. This could damage the charging port and PC.
- Do not handle the touch pen and cradle with excessive force. If you use the touch pen and cradle with excessive force, you may leave foreign substances on the screen. Clean the product with the product cleaning cloth provided.

- When multiple people use the touch pen and cradle, make sure that sufficient space is available. Collisions can cause injury or failures.

## Step of using the Pentouch program

Follow the steps below to use the Pentouch function.

- 1 Check the system requirements before installation.
- 2 Install the Pentouch program from the installation CD.
- 3 Pair the pen and the dongle.
- 4 Connect the PC and the TV.
- 5 Configure the PC screen.
- 6 Activate the Pentouch mode on the TV.
- 7 Start the Pentouch program.

## System Requirements

Make sure that the drivers are installed properly to allow proper operation of the touch pen.

- Windows 7 Starter Edition is not supported.

Supported Operating System	
Windows XP	32 bit
Windows Vista	32 bit
Windows 7	64 bit

## Recommended System Requirements for Pentouch

- CPU: Dual-Core 2GHz or better
- Memory: 1GB or more
- HDD: 500MB or more
- Display: Graphics card with 1024x768 via an RGB or HDMI output port
- Windows 7 is recommend due to its support of multi-touch.

### ! NOTE

- You must log in as an administrator to install or remove the included software.
- Make sure to install the drivers found on the CD provided.
- You can also download this program from the LG Electronics website.
- Make sure to close all running applications before installing the drivers.
- Remove old version of the Pentouch program installed on your PC before re-installing or installing new version.

## Installing the Pentouch Program

Follow the steps described in this manual to install the program.

- 1 Prepare your computer and start it.
- 2 After the computer starts, insert the CD provided. The installation screen appears automatically.  
(If the installation screen is not displayed automatically, access My computer and then click LG and index.htm to view the installation screen.)
- 3 Click [Install the Pentouch Program] in the installation window.  
The default folder is used for installation. A window appears to indicate that the installation was completed successfully.
- 4 In Windows XP, the [Found New Hardware Wizard] installs your driver automatically.
- 5 Restart your computer after the installation.

### ! NOTE

- Disconnect the USB dongle first to install the program.

## Removing the Pentouch Program

If there is a problem with the Pentouch program or if an error occurs while using the program, follow the steps below to remove the program, and then reinstall them.

- 1 On your computer, select [Start] → [Control Panel] → [Add/Remove Programs] to remove the Pentouch program.  
- The installed Pentouch program: LG Pentouch TV
- 2 Click [Yes]. A window appears telling you that the program/driver has been removed.
- 3 Please reboot your PC after removing the program.

## Pairing between Touch Pen and Dongle

### What is Pairing?

You need to pair the touch pen and the dongle before using the touch pen.

Once paired, you do not need to pair them again unless you:

- Bought a new pen
- Replaced the old pen with a new one
- Attempt to pair a new touch pen for using two pens simultaneously

### Things to Know Before Pairing

- This program allows pairing of up to two pens and one dongle.
- If you want to use two pens simultaneously, they must be paired with your dongle one at a time.
- Pairing is not possible if a paired pen is currently in use.
- If you pair a new touch pen when two pens have already been paired with your dongle, all the previous pairing data is deleted.

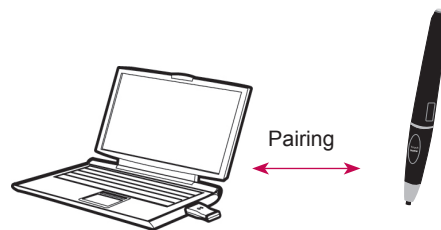

## Touch Pen

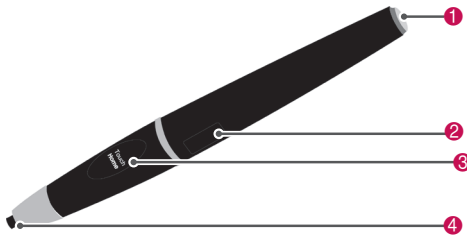

No.	Description
①	Power button / LED indicator
②	USB charging port
③	Touch Home button
④	Touch pen tip switch

## Cradle

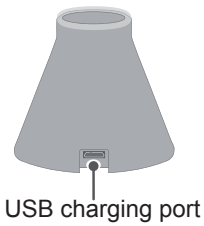

## Dongle

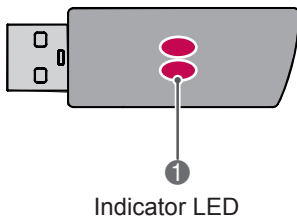
**NOTE**

- For more information, please refer to the user manual(Touch Pen,Dongle).
- Touch pens, dongles and cradle are sold separately at LG Electronics stores.
- When you leave your touch pen unused for a certain period of time (10 minutes), the pen automatically powers off.

### Pairing for the First Time

- 1 Check that the LED indicator on the dongle connected to the computer is red.
- 2 Keep the touch pen within 30 cm of the dongle.
- 3 Press the **⏻(Power)** button on the touch pen once.
- 4 The LED indicator on the touch pen will red for 2 seconds and blinks green 3 times when pairing is complete.
- 5 If the LED indicator is red for 4 ~ 5 seconds and blinks red 3 times, pairing is not successful. Please try pairing again.
- 6 Once a pen is paired, the red LED blinks once when you press the **Touch Home** button.

### When Pairing Fails

- 1 Pairing fails if the dongle driver is not installed on the computer.
- 2 Pairing fails if the LED indicator on the dongle is not red.
- 3 Remove the dongle from the PC, reinsert it and try pairing.

### Unpairing (Resetting touch pen)

- 1 Press the **Touch Home** button on the touch pen and check that the red LED blinks once.
- 2 Press the **Touch Home** button and the **⏻(Power)** button together, regardless of sequence, for more than 4 seconds.
- 3 If you release the buttons after 4 seconds, the pen will be reset. The red LED will blink three times and the pen will be turned off.

### Caution When Unpairing

- 1 Be careful not to unpair the pen by mistake. If unpaired, try pairing it again.
- 2 If you unpair and pair a normally functioning touch pen, the other paired pen may not work. In this case, unpair the nonfunctioning touch pen and pair it again by following the steps described in the Pairing for the First Time section.

### Touch pen Operation

Once paired, you can use the touch pen in the following ways.

- 1 Powering on
  - Press the **⏻(Power)** button once. The red and green LEDs will remain lit to indicate that the power is on.
- 2 Powering off
  - Press the **⏻(Power)** button for more than 3 seconds and release it. The red LED will blink 3 times and the pen will be turned off.
- 3 Pressing the **Touch Home** button while using the touch pen
  - In the Pentouch program: Shows or hides the toolbar of the feature.
  - In Windows: Works in the same way as the right-click function. Point the touch pen at an object you want to right-click, then press the button.
- 4 The double-click function may not work as intended in Windows XP or Windows Vista. If this is the case, use the **Touch Home** button (right-click) instead.
- 5 The touch pen works in the same way as the mouse in Windows.

### Tip replacement

- 1 Detach the Tip Holder and the tip to be replaced from the pen.

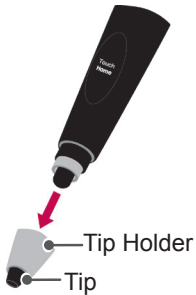

- 2 Insert a new tip into the detached Tip Holder and assemble the Tip Holder with the pen.

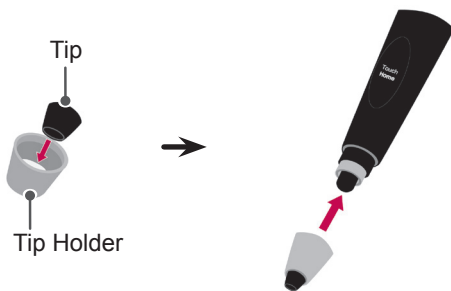

### Charging the touch pen

- 1 Charging on the cradle

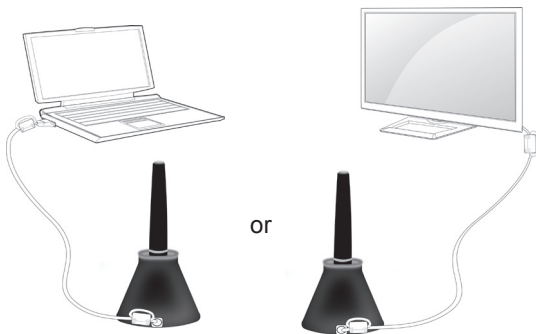

- 2 Charging directly

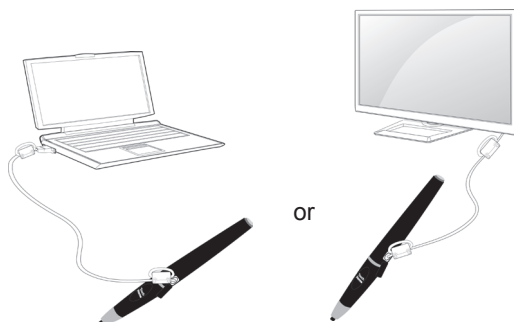

### ! NOTE

- After an hour 30 minutes of a continuous charge, you can use the touch pen for about 2 hours.
- Pentouch operation may not be normal while charging.
- Green LED will be turned on during using touch pen. If you don't use touch pen, it will be automatically turned off after 10 minute.
- Touch pen LED indicator for battery status
  - Charging: Red LED
  - Charging complete: Green LED
  - No battery power: Red LED blinks every second and powers off automatically.
  - LED ON Sleep mode: If no switch (tip switch, function key, power key) is pressed for 10 seconds, the device enters sleep mode but the LED stays green.
  - LED OFF Sleep mode: If there is no input for one minute after entering LED ON Sleep mode, the LED is turned off and the device enters LED OFF Sleep mode.
  - Power off mode: The device is powered off if there is no input for nine minutes after it has been in sleep mode for one minute.
- If the cradle is connected to the TV, the pen can be charged when the TV is switched on or is on standby.
- If the pen is connected directly to the TV through the charging cable, the pen cannot be charged when the TV is on standby.

## Using the Pentouch Function

- Image shown may differ from your TV.

You need the following items to use the Pentouch functions:

- Computer with RGB or HDMI output
- RGB or HDMI cable

- 1 After connecting the TV and the PC with an RGB cable or an HDMI cable, use the INPUT button on the remote controller and select the input connected to the PC.
- 2 Configure your PC screen by referring to the Display Resolution Setting for Pentouch section. If your PC is a notebook computer, you should configure the video to be displayed only on the TV and not on the PC screen.
- 3 Enter the Pentouch mode on your TV.
  - Press INPUT to access the input sources. Or press SETTINGS to access the main menus. Then press the navigation buttons to scroll to **Pentouch** and press **OK**.
- 4 Select the correct computer input connection to enter the Pentouch mode.

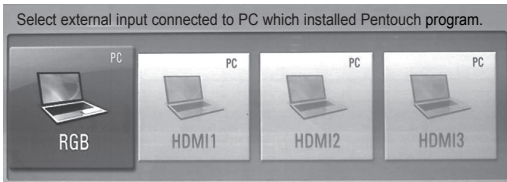

- 5 Use the touch pen or the mouse to start the Pentouch program. Pressing the **Touch Home** button on the touch pen works in the same way as right-clicking the mouse.

### NOTE

- If you turn off the TV and turn it back on while using the Pentouch function, the last screen on which you were working appears.
- To switch from Pentouch mode to others mode, either press the **INPUT** button on the remote control to select the desired input or press the **TV** button to return to the TV viewing screen.

## Display Resolution Settings for Pentouch

### On a Desktop Computer

In Windows XP

Right-click the desktop and select [Properties]. In the [Display Properties] window, set the screen resolution to 1024 x 768 under the [Settings] tab.

In Windows Vista

Right-click the desktop and select [Personalize] and [Display Settings]. Set the screen resolution to 1024 x 768 in the [Resolution] section.

In Windows 7

Right-click the desktop and select [Screen Resolution]. Set the screen resolution to 1024 x 768 in the [Resolution] section.

### On a Laptop Computer

Method 1:

On your laptop, press the "Fn + switch screen" key on the keyboard to display the computer screen on your TV screen, then set the computer's display resolution to 1024 x 768.

\* Note: The switch screen key of the laptop may be subject to change by the manufacturer.

LG	Samsung	HP	Toshiba
Fn+F7	Fn+F4	Fn+F5	Fn+F5
Sony	Acer	Dell	Lenovo
Fn+F7	Fn+ F5	Fn + F8	Fn + F7

Method 2:

Open the control panel for the graphics card on your computer.

Set [Display Mode] to the [Single Display] mode, then select [LG TV] as the display to use.

\* Set the computer's display resolution to 1024 x 768.

**NOTE**

- The method of changing display resolution settings may vary according to the computer's configuration.
- Pentouch does not support dual monitor mode or duplicate (mirror) monitor mode. Check that the PC screen is set to only be displayed on the TV.
- The switch screen key of the laptop may be subject to change by the manufacturer.

**CAUTION**

- The double-click function may not work as intended in Windows XP and Vista because these operating systems do not use touch drivers.
- The Pentouch operation may become slow depending on the computer's performance.
- The screen size may change if you disconnect the computer's output port and connect it again. If this happens, set the computer resolution again.
- If nothing is shown on the TV and the laptop screen when you press the switch screen key (Fn + manufacturer-specified key), try pressing the key again.
- The TV screen size may become smaller when you press the switch screen key (Fn + manufacturer-specified key). If this happens, adjust the resolution again.
- Changing the desktop icon properties in Windows 7 may affect the Pentouch program.
- It is recommended not to run other applications while using the Pentouch program.
- If the point you touch on the TV screen using the touch pen and the point indicated as touched on the computer screen do not match when the computer and TV are connected by a PC signal (RGB) cable, use the TV remote control to select [SETTINGS] → [PICTURE] → [SCREEN] (RGB), then select [Auto Configure] to adjust the screen.
- If the PC and TV are only connected by a PC (RGB) signal cable, there will be no sound from the TV. Please connect the PC and the TV with a PC audio cable as well.

- The Play Video function in Photo Editor may not work as intended, depending on the codecs installed on your computer.
- Eraser function could be slower if drawing objects are overlapped exceed program performance depends on PC environment.
- If you want to open programs with a single click in Window XP or Vista, On your PC, go to Start → Control Panel → Folder Options and select "Single-click to open an item (point to select)."
- If your PC is running Windows XP, the virtual keyboard will only support English.
- When changing to the Pentouch mode, or when changing the resolution in Pentouch mode for RGB input signals, images may not be displayed properly for a while due to auto adjustment.
- Make sure that there are not many metal obstacles between a pen and dongle. Otherwise, the function may not work properly.
- The Pentouch function may not work normally where the TV screen is too bright due to the light from other light source.

## Checking the Pentouch Functions

- Image shown may differ from your TV.

You see the home screen shown below when you start the Pentouch program.

- Press INPUT button on the remote control or SETTINGS to access the main menus. Then press the navigation buttons to scroll to Pentouch and press OK.

**NOTE**

- You can also access the pentouch functions by selecting **Pentouch** in the main menus.

- Touch the screen with the touch pen to select **Sketchbook, Photo Editor, Family Diary, Gallery, Internet** or **My Office**.

No.	Description
①	<b>Sketchbook</b> Select the background you want, then draw pictures on it.
②	<b>Photo Editor</b> Draw or edit pictures on photos and videos.
③	<b>Family Diary</b> A journal of photos, videos, notes, and sketches for family events by date.
④	<b>Gallery</b> A collection of pictures drawn and saved in Sketchbook, Photo Editor, internet and My Office.
⑤	<b>Internet</b> Launch the Web browser to capture the Web content, then draw or write memos on it.
⑥	<b>My Office</b> Supports the glass effect in Microsoft Office and PDF files.
⑦	Touch pen battery level
⑧	Saving and opening folder location, screen saver and language settings
⑨	Quit the Pentouch program.

When you select the **Setting**,

- Select **Setting** from the Pentouch Home screen with the touch pen.
- Select the desired option.

Option	Description
Open Folder	Select a folder from which you will open photos or video files.
Save Folder	Select a folder to which you want to save images.
Screensaver	Select the standby time for the screensaver.
Language	Select and change the language you wish to work in.

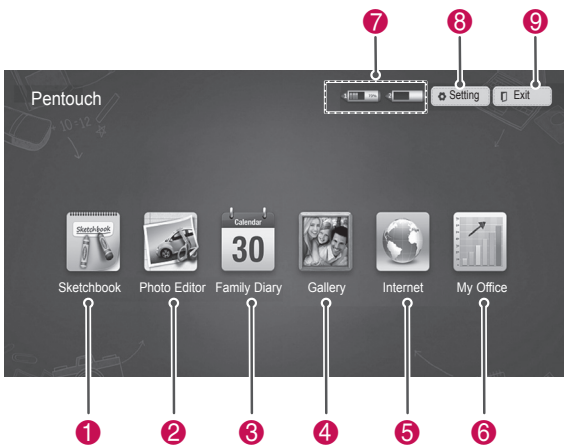

## Using Toolbar

You can use the draw toolbar on all menu screens.

Display the toolbar by pointing the touch pen at the bottom of the screen.

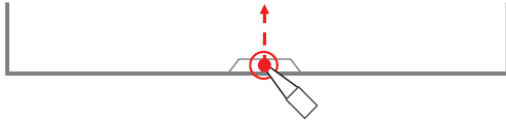

There are two types of toolbars: fixed and specialized.

- The fixed toolbar provides the functions used for all menus.
- The specialized toolbar provides the functions used for a specific menu.

### Fixed Toolbar Functions

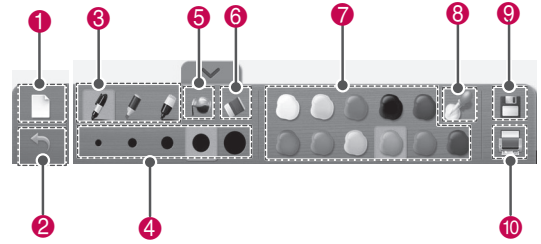

No.	Description
1	Reset: Remove the background and all the drawings.
2	Undo: Undo up to 5 recent actions.
3	Drawing tools: Ink pen, highlighter pen, magic pen.
4	Select the thickness of the current drawing tool.
5	Paint bucket: Fill a closed area with the selected colour.
6	Eraser
7	Colour selector: Select a colour for the current drawing tool.
8	Free colour selector: Select any colour from the colour wheel.
9	Save
10	Print Set the printer, print range and number of copies. Preview is also available.

\* Descriptions for the specialized toolbar functions are provided in the menu function description section.

## Using Sketchbook

You can select the background you want, then draw pictures on it.

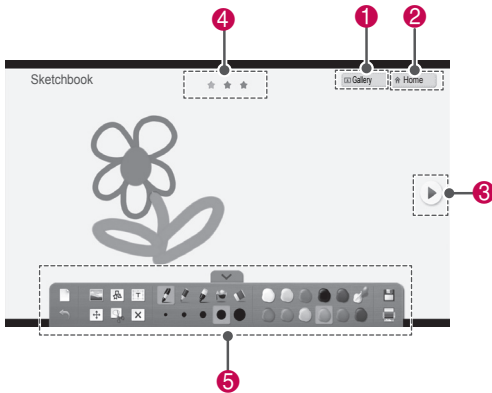

- 1 Touch the screen with the touch pen to select Sketchbook.
- 2 Touch the screen with the touch pen to select the desired option or use the toolbar to draw a picture.

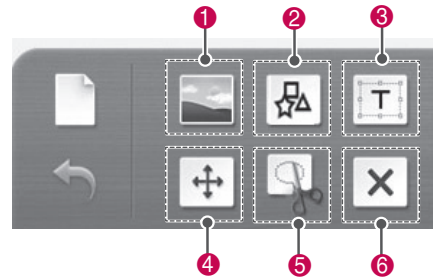

No.	Description
1	Enter Gallery.
2	Enter the Pentouch Home menu.
3	Select them to go to the previous page or next page. You can move up to 3 pages.
4	Current page position
5	Toolbar functions

### Specialized toolbar functions



Menu	Description
1	Select image for background. 
2	Insert basic figures. Select the desired icon, then short tap to create a default size figure. 
3	Insert text. If you select an area to enter the text, a keyboard will be displayed on the screen. For some operating systems, two virtual keyboards may be displayed. 

When dragging a line, pen or shape, you can only move or resize a single object at a time.

If you short tap an object and drag, the area of the selected object will be displayed.

**Move**

You can move an object by dragging the area of the selected object.

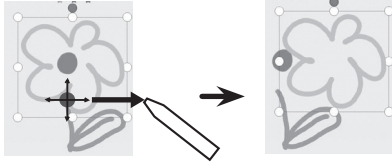

**Expansion / Reduction**

You can expand or reduce an object by dragging one of the 8 corners of the selected object. The object will be resized based on the corresponding corner/edge.

4

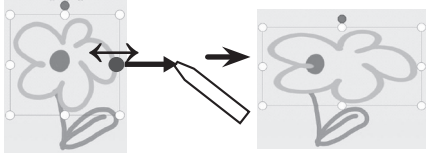

**Rotation**

Drag in rotation to rotate the selected object.

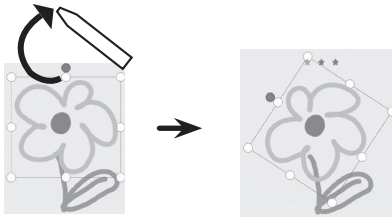

Cut the range and Move / Expansion / Reduction / Rotation.

5

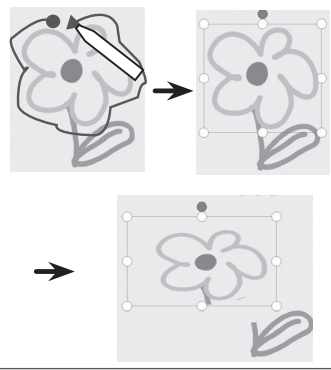

Delete object from the screen.

6

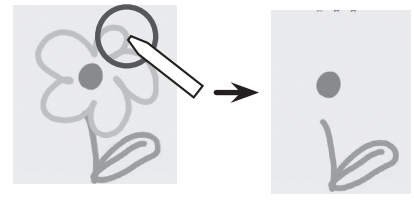

## Using Photo Editor

You can draw or edit image on photos and video capture images.

- 1 Touch the screen with the touch pen to select **Photo Editor**.
- 2 Touch the screen with the touch pen to select the desired option.

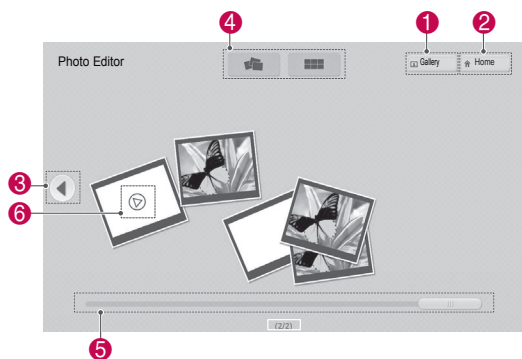

No.	Description
1	Enter Gallery.
2	Enter the Pentouch Home menu.
3	Select them to go to the previous page or next page.
4	Select photo list view option. ( Scattered view /Sorted view )
5	Page navigation scrollbar
6	Only one video can be played at a time; the previously playing video is paused.

- 3 Select the photo or video you wish to decorate. You can decorate the photo with the toolbar.

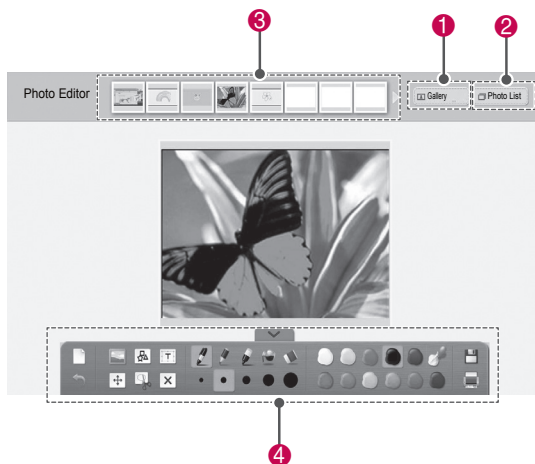

No.	Description
1	Enter Gallery.
2	Open Photo list
3	Previews of all photos and videos in the folder are shown here. (from new to old)
4	Toolbar functions

### NOTE

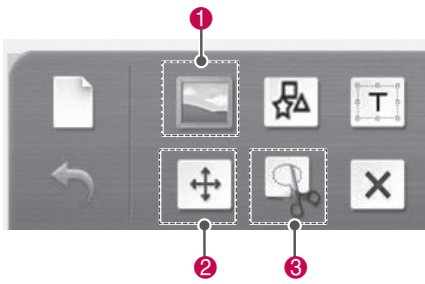

- When working with a video, you can use the pause button and extract the image of the paused frame to use it in Photo Editor.
- You can edit the photos or videos stored in the **Photo List**.
- The TV may not properly play the video files in the Pentouch mode depending on your computer.

Specialized toolbar functions



③ Cut from the image.

After select area to cut, you can change it's size.

No.	Description
①	<p>Frame for image.</p>
②	<p>Move an object.</p> <p>If you select an object, a mini pop-up window will display.</p> <ul style="list-style-type: none"> <li data-bbox="216 1535 661 1599">  Bring to Front.                 </li> <li data-bbox="216 1605 661 1669">  Send to Back.                 </li> <li data-bbox="216 1675 661 1738">  Delete.                 </li> </ul>

## Using Family Diary

You can keep a journal of photos, videos, notes, and sketches for family events by date.

- 1 Touch the screen with the touch pen to select **Family Diary**.
- 2 Select the desired date with the touch pen.

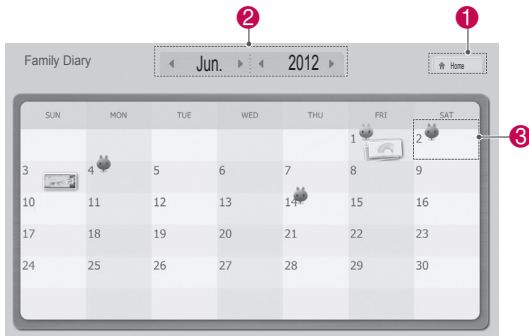

- 3 Use the toolbar to create and decorate the family diary.

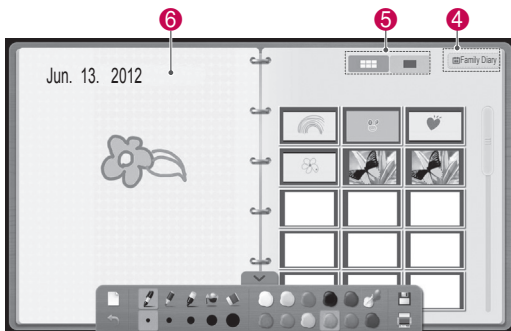

No.	Description
1	Enter the Pentouch Home menu.
2	Select date.
3	Dates with images are shown with icons. Select a date with images to see the screen.
4	Open the Family diary screen.
5	Select Preview or Full Screen.
6	Draw or write here.

## Using Gallery

This is the gallery of the images you made and saved using Sketchbook, Photo Editor, Internet and My office.

- 1 Touch the screen with the touch pen to select **Gallery**.
- 2 Touch the screen with the touch pen to select the desired option, and enjoy the Gallery screen.

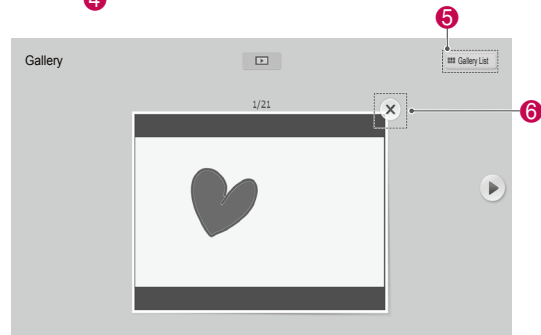
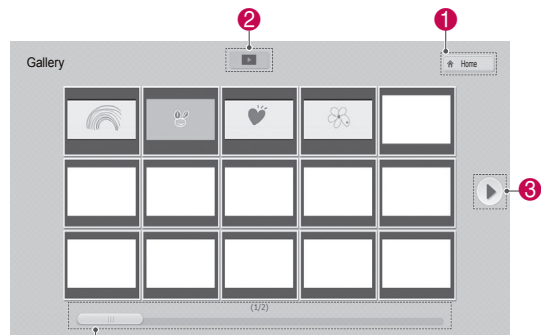

No.	Description
1	Enter the Pentouch Home menu
2	Start slideshow from the first image on the current page. To stop the slide show, touch the screen while the slide show is playing with the touch pen. This will take you back to the previous screen.
3	Page button: Select them to go to the previous page or next page.
4	Page navigation scrollbar
5	Enter the Gallery List
6	When selected, the current image is deleted and the next image is displayed.

## Using Internet

You can capture Web content to draw or write memos on it.

- 1 Touch the screen with the touch pen to select **Internet**.
- 2 Touch the screen with the touch pen to select the desired option or use the toolbar.

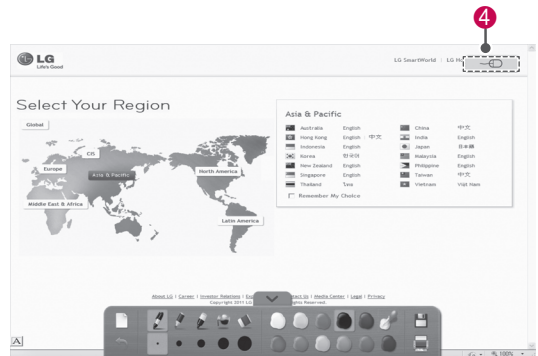
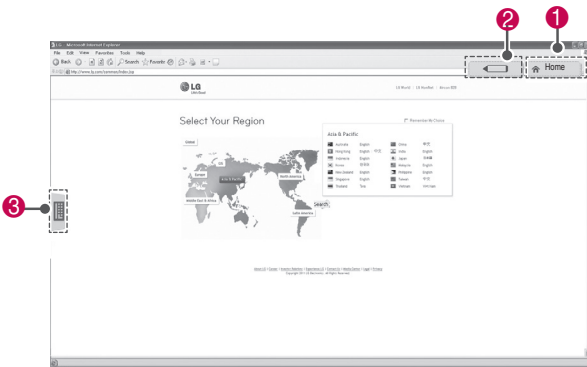

No.	Description
1	Enter the Pentouch Home menu.
2	If you select a pen icon on your TV, the drawing mode will be activated. When in drawing mode, the virtual keyboard will be hidden.
3	Virtual keyboard tab : Insert text. Select the virtual keyboard tab to display the keyboard on the screen. For some operating systems, two virtual keyboards may be displayed.
4	Returns to the previous level. Drawings will be cleared when you exit the drawing mode.

## Using the My Office function

You can draw or write in Microsoft Office or PDF files.

- Applications that support Microsoft Office and PDF files must be installed on your computer.
- Folders and formats supported are displayed in a window.

### Supported file format

Type	Supported file format
Office Files	2003 version ppt, doc, xls
	2007 version pptx, docx, xlsx
	All Microsoft PowerPoint files (*.ppt, .pptx)
	All Microsoft Word files (*.doc, .docx)
	All Microsoft Excel files (*.xls, .xlsx)
	Outlook data files (*.msg, *.eml)
PDF Files	Adobe PDF files (*.pdf)

- 1 Touch the screen with the touch pen to select **My Office**.
- 2 Touch the screen with the touch pen, then in the Open popup window, select the file to open.
- 3 Touch the screen with the touch pen to select the desired option or use the toolbar.

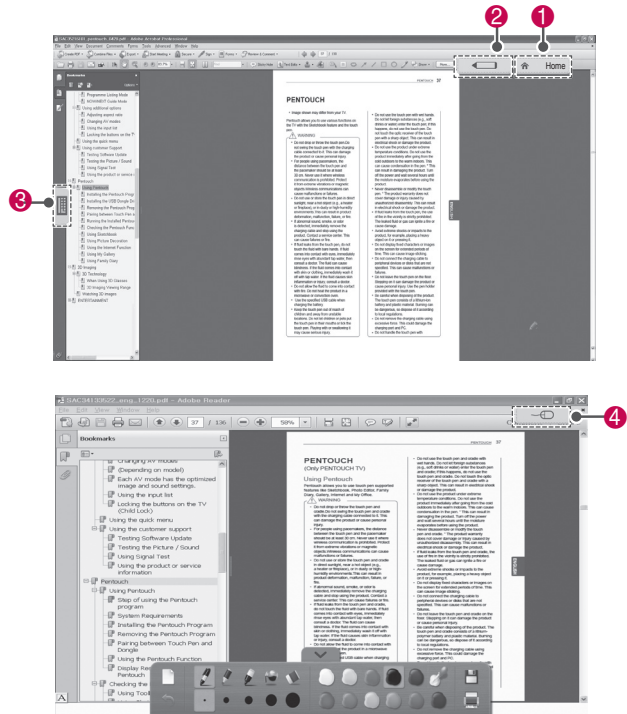

No.	Description
1	Enter the Pentouch Home menu.
2	If you select a pen icon on your TV, the drawing mode will be activated. When in drawing mode, the virtual keyboard will be hidden.
3	Virtual keyboard tab : Insert text. Select the virtual keyboard tab to display the keyboard on the screen. For some operating systems, two virtual keyboards may be displayed.
4	If you select a mouse icon on your TV, the click mode will be activated. Drawings will be cleared when you exit the drawing mode.

# NETWORK SETTING

## Connecting to a wired network

(Depending on model)

Connect the TV to a local area network (LAN) via the LAN port as shown on the following illustration and set up the network settings. (See p.80).

After making a physical connection, a small number of home networks may require the TV network settings to be adjusted. For most home networks, the TV will connect to automatically without any adjustments.

For detail information, contact your internet provider or router manual.

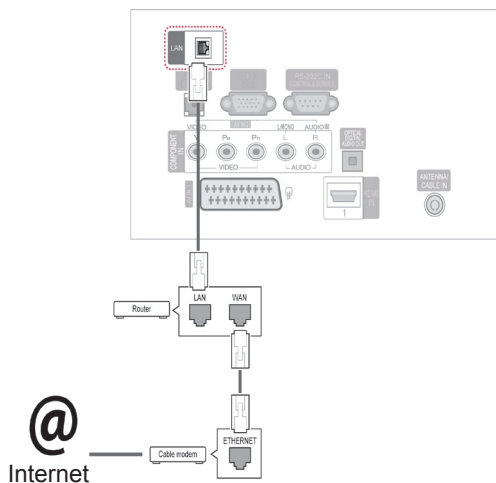

### CAUTION

- Do not connect a modular phone cable to the LAN port.
- Since there are various connection methods, please follow the specifications of your telecommunication carrier or internet service provider.

To set up the network settings: (Even if your TV has already connected automatically, running setup again will not harm anything),

- 1 Press **SETTINGS** to access the main menus.
- 2 Press the Navigation buttons to scroll to **SETUP** and press **OK**.
- 3 Press the Navigation buttons to scroll to **NETWORK** and press **OK**.
- 4 Press the Navigation buttons to select **Network Setting** and press **OK**.
- 5 If wired and wireless are simultaneously connected, press the Navigation buttons to select **Wired** and press **OK**.
- 6 If you already set Network Setting, select **Resetting**. The new connection settings resets the current network settings.
- 7 Select **IP Auto Setting** or **IP Manual Setting**.
  - If selecting **IP Manual Setting**, press the Navigation and Number buttons. IP addresses will need to be input manually.
  - **IP Auto Setting**: Select this if there is a DHCP server (Router) on the local area network (LAN) via wired connection, the TV will automatically be allocated an IP address. If you're using a broadband router or broadband modem that has a DHCP (Dynamic Host Configuration Protocol) server function. The IP address will automatically be determined.
- 8 When you are finished, press **EXIT**.

**NOTE**

- If you want to access the Internet directly on your TV, the broadband internet connection should always be on.
- If you cannot access the Internet, check the network conditions from a PC on your network.
- When you use **Network Setting**, check the LAN cable or check if DHCP in the router is turned on.
- If you do not complete the network settings, the network may not work properly.

**Tips for Network setting**

- Use a standard LAN cable with this TV. Cat5 or better with a RJ45 connector.
- Many network connection problems during set up can often be fixed by re-setting the router or modem. After connecting the player to the home network, quickly power off and/or disconnect the power cable of the home network router or cable modem. Then power on and/or connect the power cable again.
- Depending on the internet service provider (ISP), the number of devices that can receive internet service may be limited by the applicable terms of service. For details, contact your ISP.
- LG is not responsible for any malfunction of the TV and/or the internet connection feature due to communication errors/malfunctions associated with your broadband internet connection, or other connected equipment.
- LG is not responsible for problems within your internet connection.
- Some content available through the network connection may not be compatible with the TV. If you have questions about such content, please contact the producer of the content.
- You may experience undesired results if the network connection speed does not meet the requirements of the content being accessed.
- Some internet connection operations may not be possible due to certain restrictions set by the Internet service provider (ISP) supplying your broadband Internet connection.
- Any fees charged by an ISP including, without limitation, connection charges are your responsibility.

- A 10 Base-T or 100 Base-TX LAN port is required when using a wired connection to this TV. If your internet service does not allow for such a connection, you will not be able to connect the TV.
- A DSL modem is required to use DSL service and a cable modem is required to use cable modem service. Depending on the access method of and subscriber agreement with your ISP, you may not be able to use the internet connection feature contained in this TV or you may be limited to the number of devices you can connect at the same time. (If your ISP limits sub-scription to one device, this TV may not be allowed to connect when a PC is already connected.)
- The use of a "Router" may not be allowed or its usage may be limited depending on the policies and restrictions of your ISP. For details, contact your ISP directly.

**Network Status**

- 1 Press **SETTINGS** to access the main menus.
- 2 Press the Navigation buttons to scroll to **NETWORK** and press **OK**.
- 3 Press the Navigation buttons to select **Network Status**.
- 4 Press **OK** to check the network status.
- 5 When you are finished, press **EXIT**.

Option	Description
<b>Setting</b>	Return to the network setting menu.
<b>Test</b>	Test the current network status after setting the network.
<b>Close</b>	Return to the previous menu.

# ENTERTAINMENT

## Connecting USB storage devices

Connect USB storage devices such as a USB flash memory, external hard drive to the TV and use multimedia features (See “Browsing files” on p.57).

Connect a USB flash memory or USB memory card reader to the TV as shown on the following illustration. The My media screen appears.

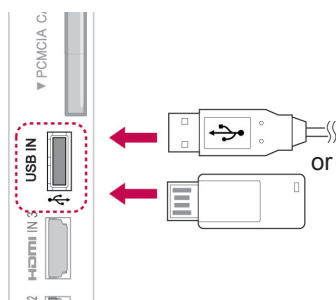

To disconnect a USB storage device, make sure to end the connection properly to prevent damages to the TV or files.

- 1 Press **Q.MENU** to access the quick menus.
- 2 Press the Navigation buttons to scroll to **USB Device** and press **OK**.
- 3 Press the Navigation buttons to scroll to **Eject** and press **OK**.
- 4 Disconnect the USB storage device only when the message says that it is safe to remove.



### CAUTION

- Do not turn the TV off or remove a USB storage device while the USB storage device is connected to the TV, as this could result in loss of files or damage to the USB storage device.
- Back up your files saved on a USB storage device frequently, as you may lose or damage the files and this may be not covered by the warranty.

### Tips for using USB storage devices

- Only a USB storage device is recognizable.
- If the USB storage device is connected through a USB hub, the device is not recognizable.
- A USB storage device using an automatic recognition program may not be recognized.
- A USB storage device which uses its own driver may not be recognized.
- The recognition speed of a USB storage device may depend on each device.
- Please do not turn off the TV or unplug the USB device when the connected USB storage device is working. When such device is suddenly separated or unplugged, the stored files or the USB storage device may be damaged.
- Please do not connect the USB storage device which was artificially maneuvered on the PC. The device may cause the product to malfunction or fail to be played. Never forget to use only a USB storage device which has normal music files, image files or movie files.
- Please use only a USB storage device which was formatted as a FAT32 file system, NTFS file system provided with the Windows operating system. In case of a storage device formatted as a different utility program which is not supported by Windows, it may not be recognized.
- Please connect power to a USB storage device(over 0.5 A) which requires an external power supply. If not, the device may not be recognized.
- Please connect a USB storage device with the cable offered by the device maker.
- Some USB storage devices may not be supported or operated smoothly.
- File alignment method of USB storage device is similar to Window XP and filename can recognize up to 100 English characters.
- Be sure to back up important files since data stored in a USB memory device may be damaged. We will not be responsible for any data loss.
- If the USB HDD does not have an external power source, the USB device may not be detected. So be sure to connect the external power source.
  - Please use a power adaptor for an external power source. We do not guarantee an USB cable for an external power source.

- If your USB memory device has multiple partitions, or if you use a USB multi-card reader, you can use up to 4 partitions or USB memory devices.
- If a USB memory device is connected to a USB multi-card reader, its volume data may not be detected.
- If the USB memory device does not work properly, disconnect and reconnect it.
- How fast a USB memory device is detected differs from device to device.
- If the USB is connected in Standby Mode, specific hard disk will automatically be loaded when the TV is turned on.
- The recommended capacity is 1 TB or less for a USB external hard disk and 32 GB or less for USB memory.
- Any device with more than the recommended capacity may not work properly.
- If a USB external hard disk with a “Energy Saving” function does not work, turn the hard disk off and on again to make it work properly.
- USB storage devices below USB 2.0 are supported as well. But they may not work properly in the movie list.
- Maximum of 999 folders or files can be recognized under one folder.
- If there are too many folders and files in one folder, it may not operate properly.

## Browsing files

Access the photo, music, or movie lists and browse files.

- 1 Connect a USB storage device.
- 2 Press **SETTINGS** to scroll to main menus.
- 3 Press the Navigation buttons to scroll to **My Media** and press **OK**.
- 4 Press Navigation buttons to scroll to **Photo List**, **Music List**, or **Movie List** and press **OK**.

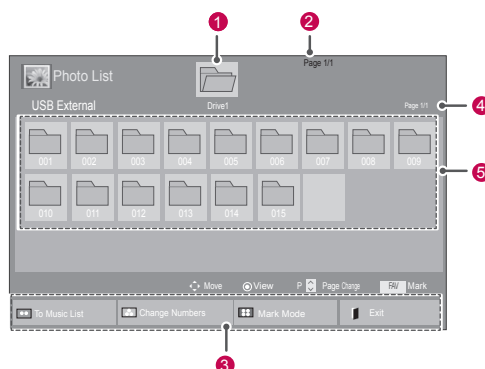
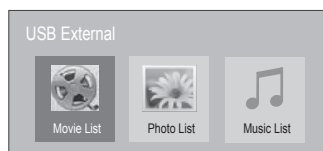

No.	Description
1	Moves to upper level folder
2	Current page/Total pages
3	Corresponding buttons on the remote control
4	Current page/ total pages of contents under the folder focused on 1
5	Contents under the folder focused on 1
Button	Description
Green button	Repeatedly, press the GREEN button to converted to <b>Photo List-&gt;Music List, Music List-&gt;Movie List or Movie List-&gt;Photo List.</b>
Yellow button	A method to view in 5 large thumbnail or simple list.
Blue button	Convert to Mark Mode.

## Supported file format

Type	Supported file format
<b>Movie</b>	<p>DAT,MPG,MPEG,VOB,AVI,DIVX,MP4,MKV,TS,TRP,TP,ASF,WMMV,FLV)</p> <p><b>Movie</b>(* .mpg/* .mpeg/* .dat/* .ts/* .trp/* .tp/* .vob/* .mp4/* .mov/* .mkv/* .divx/* .avi/* .asf/* .wmv/* .flv/* .avi(motion-jpeg)/* .mp4(motion-jpeg)/* .mkv(motion-jpeg))supporting file</p> <p><b>Video format</b> : DivX3.11, DivX4.12, DivX5.x, DivX6, Xvid1.00, Xvid1.01, Xvid1.02, Xvid1.03, Xvid1.10 beta-1/beta-2, Mpeg-1, Mpeg-2, Mpeg-4, H.264/AVC, VC1, JPEG, Sorenson H.263</p> <p><b>Audio format</b> : Dolby Digital, Mpeg, MP3, LPCM, ADPCM, WMA</p> <p><b>Bit rate</b> : within 32 kbps to 320 kbps(MP3)</p> <p><b>External Subtitle format</b> : *.smi/* .srt/* .sub (MicroDVD,Subviewer1.0/2.0)/* .ass/* .ssa/* .txt(TMPlayer)/* .psb(PowerDivX)</p> <p><b>Internal Subtitle format</b> : only, XSUB (It is the subtitle format used in DivX6 files)</p>
<b>Photo</b>	<p>JPEG</p> <p>Baseline : 64 x 64 to 15360 x 8640 Progressive : 64 x 64 to 1920 x 1440</p> <ul style="list-style-type: none"> <li>You can play JPEG files only.</li> <li>Non-supported files are displayed in the form of predefined icon.</li> </ul>
<b>Music</b>	<p>MP3</p> <p>Bit rate 32 to 320</p> <ul style="list-style-type: none"> <li>Sampling rate MPEG1 Layer3 : 32 kHz, 44.1 kHz, 48 kHz</li> <li>Sampling rate MPEG2 Layer3 : 16 kHz, 22.05 kHz, 24 kHz</li> <li>Sampling rate MPEG2.5 Layer3 : 8 kHz, 11.025 kHz, 12 kHz</li> </ul>

## Viewing movies

Play video files on the TV. Your TV displays all of the video files saved in a USB storage device or shared folder on a PC.

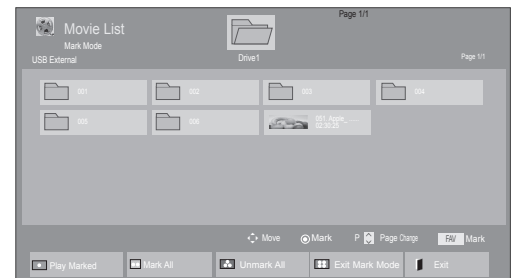
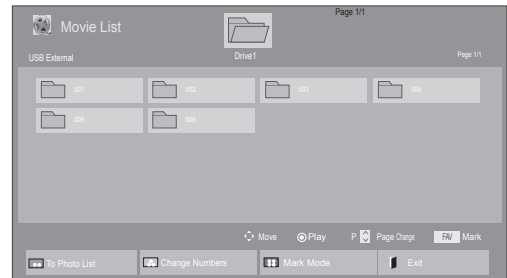

- 1 Press **SETTINGS** to access the main menus.
- 2 Press the Navigation buttons to scroll to **My Media** and press **OK**.
- 3 Press the Navigation buttons to scroll to **Movie List** and press **OK**.
- 4 Select **Drive1** to access the connected USB storage device.
- 5 Press the Navigation buttons to scroll to a folder you want and press **OK**.
- 6 Press the Navigation buttons to scroll to a file you want and press **OK**.



Menu	Description
<b>Play Marked</b>	Play the selected movie file. Once a movie file finishes playing, the next selected one will be played automatically.
<b>Mark All</b>	Mark all movie files on the screen.
<b>Unmark All</b>	Deselect all marked movie files.
<b>Exit Mark Mode</b>	Exit the Mark Mode.







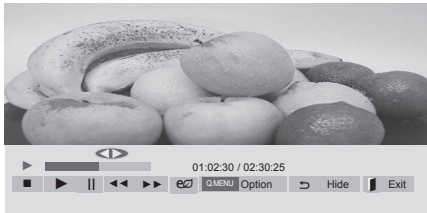

## 7 Play a movie.

### NOTE

- Non-supported files are displayed the preview image by icon only .
- Abnormal files are displayed in the form of bitmap .

## 8 Control playback by using the following buttons.



Button	Description
	Stops the playback
	Plays a video
	Pauses or resumes the playback
	Scans backward in a file
	Scans forward in a file
 and 	Plays videos in slow motion.
<b>Q.MENU</b>	Show the <b>Option</b> menu.
	Hide the menu on the full-sized screen.
<b>EXIT</b>	Return to <b>Movie List</b> .
<b>&lt; or &gt;</b>	Skips to specific points in a file during playback. The time of a specific point will appear on the status bar. In some files, this function may not work properly.
<b>ENERGY SAVING</b>	Press the <b>ENERGY SAVING</b> button repeatedly to increase the brightness of your screen.
<b>AV MODE</b> (Depending on model)	Press the <b>AV MODE</b> button repeatedly to select the desired source.

### Tips for using playing video files

- Some user-created subtitles may not work properly.
- Some special characters are not supported in subtitles.
- HTML tags are not supported in subtitles.
- Subtitles in languages other than the supported languages are not available.
- The screen may suffer temporary interruptions (image stoppage, faster playback, etc.) when the audio language is changed.
- A damaged movie file may not be played correctly, or some player functions may not be usable.
- Movie files produced with some encoders may not be played correctly.
- If the video and audio structure of recorded file is not interleaved, either video or audio is outputted.
- HD videos with a maximum of 1920x1080@25/30P or 1280x720@50/60P are supported, depending on the frame.
- Videos with resolutions higher than 1920X1080@25/30P or 1280x720@50/60P may not work properly depending on the frame.
- Movie files other than the specified types and formats may not work properly.
- Max bitrate of playable movie file is 20 Mbps. (only, Motion JPEG : 10 Mbps)
- We do not guarantee smooth playback of profiles encoded level 4.1 or higher in H.264/AVC.
- DTS Audio codec is not supported.
- A movie file more than 30 GB in file size is not supported for playback. The file size limit is dependent on the encoding environment.
- A DivX movie file and its subtitle file must be located in the same folder.
- A video file name and its subtitle file name must be identical for it to be displayed.
- Playing a video via a USB connection that doesn't support high speed may not work properly.
- Files encoded with GMC(Global Motion Compensation) may not be played.
- When you are watching the movie by Movie List function, you can adjust an image by Energy Saving and AV Mode(Depending on model) button on the remote control. User setup for each image mode does not operate.
- Video file names that contain special characters may not be playable.

## Video options

- 1 Press **Q. MENU** to access the **Pop-Up** menus.
- 2 Press the Navigation buttons to scroll to **Set Video Play.**, **Set Video.** or **Set Audio.** and press **OK**.

 **NOTE**

- Option values changed in **Movie List** does not affect **Photo List** and **Music List**.
- Option value changed in **Photo List** and **Music List** are changed likewise in **Photo List** and **Music List** excluding **Movie List**.
- When replaying the video file after stopping, you can play from where it stopped previously.

When you select the **Set Video Play**.

- 1 Press the Navigation buttons to scroll to show the **Picture Size**, **Audio Language**, **Subtitle Language** or **Repeat**.
- 2 Press the Navigation buttons to scroll to make appropriate adjustments.

Menu	Description
<b>Picture Size</b>	Selects your desired picture format during movie play.
<b>Audio Language</b>	Changes the Language Group of the audio during movie play. Files with a single audio track cannot be selected.
<b>Subtitle Language</b>	Turn on/off the subtitle.
<b>Language</b>	Activated for SMI subtitle and can select the language within the subtitle.
<b>Code Page</b>	Can select the font for subtitle. When set to default, same font as general menu will be used.

<b>Sync</b>	Adjusts the time synchronisation of the subtitle from -10 secs to +10 secs by steps of 0.5 secs during movie play.
<b>Position</b>	Changes the position of the subtitle either up or down during movie play.
<b>Size</b>	Selects your desired Subtitle size during movie play.
<b>Repeat</b>	Turn on/off repeat function of movie playback. When turned on, the file within the folder will be played back repeatedly. Even when the repeated playback is turned off, it can run the playback if the file name is similar to the previous file.

Subtitle Language	Support Language
<b>Latin1</b>	English, Spanish, French, German, Italian, Swedish, Finnish, Dutch, Portuguese, Danish, Romanian, Norwegian, Albanian, Gaelic, Welsh, Irish, Catalan, Valencian
<b>Latin2</b>	Bosnian, Polish, Croatian, Czech, Slovak, Slovenian, Serbian, Hungarian
<b>Latin4</b>	Estonian, Latvian, Lithuanian
<b>Cyrillic</b>	Bulgarian, Macedonian, Russian, Ukrainian, Kazakh
<b>Greek</b>	Greek
<b>Turkish</b>	Turkish

 **NOTE**

- Only 10,000 of sync blocks can be supported within the subtitle file.
- When playing a video, you can adjust the Picture Size by pressing the **RATIO** button.

When you select the **Set Video**.

- 1 Press the Navigation buttons to scroll to make appropriate adjustments. (See p.67)

When you select the **Set Audio**.

- 1 Press the Navigation buttons to scroll to show the **Sound Mode, Auto Volume, Clear Voice II** or **Balance**.
- 2 Press the Navigation buttons to scroll to make appropriate adjustments. (See p.72)

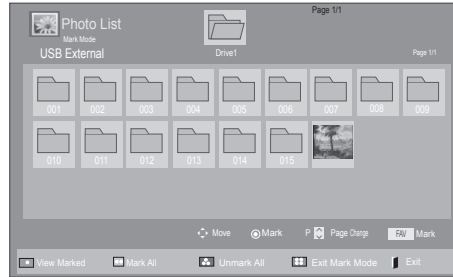
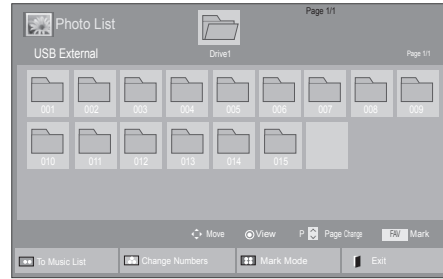

Menu	Description
<b>View Marked</b>	Display the selected photo file.
<b>Mark All</b>	Mark all photo files on the screen.
<b>Unmark All</b>	Deselect all marked photo files.
<b>Exit Mark Mode</b>	Exit the Mark Mode.



## Viewing photos

View image files saved in a USB storage device or shared folder on a PC through the network connection. The displays on the screen may differ from the model.

- 1 Press **SETTINGS** to access the main menus.
- 2 Press the Navigation buttons to scroll to **My Media** and press **OK**.
- 3 Press the Navigation buttons to scroll to **Photo List** and press **OK**.
- 4 Press the Navigation buttons to select **Drive1** to access the connected USB storage device.
- 5 Press the Navigation buttons to scroll to a folder you want and press **OK**.
- 6 Press the Navigation buttons to scroll to a file you want and press **OK**.

- 7 View photos.

### NOTE

- Non-supported files are displayed the pre-view image by icon only .
- Abnormal files are displayed in the form of bitmap .

Using photo options

Use the following options while viewing photos.



Options

Number of selected photos

<b>Option</b>	<ul style="list-style-type: none"> <li>• <b>Slide Speed:</b> Selects a slideshow speed (<b>Fast</b>, <b>Medium</b>, <b>Slow</b>).</li> <li>• <b>BGM:</b> Selects a music folder for the background music.</li> </ul> <div style="border: 1px solid black; padding: 5px; margin-top: 10px;"> <p><b>NOTE</b></p> <ul style="list-style-type: none"> <li>• You cannot change the music folder while the background music is playing.</li> <li>• You can only select the MP3 folder saved on the device that currently displays the photo.</li> </ul> </div>
<b>Hide</b>	Hides the option window. To display the options, press <b>OK</b> .
<b>EXIT</b>	Return to <b>Photo List</b> .

Option	Description
<b>Slideshow</b>	Starts or stops a slideshow with selected photos. If there are no selected photos, all photos saved in the current folder display during a slideshow. To set a slideshow speed, select <b>Option</b> .
<b>BGM</b>	Turns the background music on or off. To set the background music folder, select <b>Option</b> . You can adjust Option by Q.MENU or SETTINGS button on the remote control.
<b>⤵ (Rotate)</b>	Rotates photos clockwise (90°, 180°, 270°, 360°).  <div style="border: 1px solid black; padding: 5px; margin-top: 10px;"> <p><b>NOTE</b></p> <ul style="list-style-type: none"> <li>• The supported photo size is limited. You cannot rotate a photo if the resolution of the rotated width is larger than the supported resolution size.</li> </ul> </div>
<b>Q</b>	View the photo by zoom in 2, 4 times.
<b>ENERGY SAVING</b>	Press the <b>ENERGY SAVING</b> button repeatedly to change the brightness of your screen.

ENGLISH

Photo options

- 1 Press **Q. MENU** or **SETTINGS** to show the **Option** menus.
- 2 Press the Navigation buttons to scroll to **Set Photo View.**, **Set Video.** or **Set Audio.** and press **OK**.

**NOTE**

- Option values changed in **Movie List** does not affect **Photo List** and **Music List**.
- Option value changed in **Photo List** and **Music List** are changed likewise in **Photo List** and **Music List** excluding **Movie List**.

When you select the **Set Photo View**,

- 1 Press the Navigation buttons to scroll to select **Slide Speed** or **BGM**.
- 2 Press the Navigation buttons to scroll to make appropriate adjustments.

When you select the **Set Video**.

- 1 Press the Navigation buttons to scroll to make appropriate adjustments. (See p.67)

When you select the **Set Audio**.

- 1 Press the Navigation buttons to scroll to show the **Sound Mode, Auto Volume, Clear Voice II** or **Balance**.
- 2 Press the Navigation buttons to scroll to make appropriate adjustments. (See p.72)

### Listening to music

- 1 Press **SETTINGS** to access the main menus.
- 2 Press the Navigation buttons to scroll to **My Media** and press **OK**.
- 3 Press the Navigation buttons to scroll to **Music List** and press **OK**.
- 4 Press the Navigation buttons to select **Drive1** to access the connected USB storage device.
- 5 Press the Navigation buttons to scroll to a folder you want and press **OK**.
- 6 Press the Navigation buttons to scroll to a file you want and press **OK**.

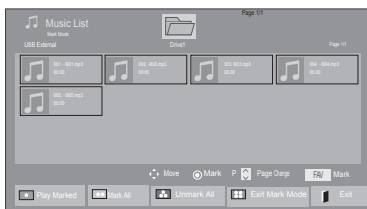
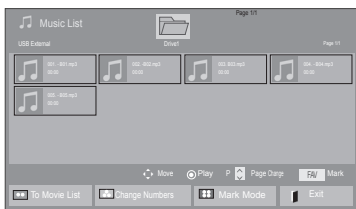

Menu	Description
<b>Play Marked</b>	Display the selected music file.
<b>Mark All</b>	Mark all music files on the screen.
<b>Unmark All</b>	Deselect all marked music files.
<b>Exit Mark Mode</b>	Exit the Mark Mode.

- 7 Play music.
- 8 Control playback by using the following buttons.

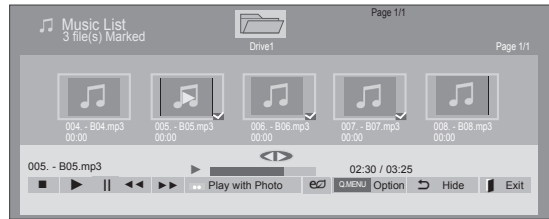











Button	Description
	Stops playback
	Plays a music file
	Pauses or resumes playback
	Skips to the next file
	Skips to the previous file
or	When playing, When you press the  button, the previous music file will be played. When you press the  button, the next music file will be played.
Green button	Start playing the selected music files and then move to the <b>Photo List</b> .
<b>ENERGY SAVING</b>	Press the <b>ENERGY SAVING</b> button repeatedly to change the brightness of your screen.
<b>Q.MENU</b>	Show the Option menu.
	Hides the option window. To display the options, press <b>OK</b> .
<b>EXIT</b>	When you press the <b>EXIT</b> button while the Music player is displayed, only the music will be stopped and the player will not return to normal TV viewing. When you press the <b>EXIT</b> button while the music is stopped or while the music player is hidden, the player will return to normal TV viewing.
	When using the  button during playback a cursor indicating the position can be played.

ENGLISH

#### Tips for playing music files

- This unit cannot support the ID3 Tag embedded MP3 files.

### ! NOTE

- Non-supported files are displayed the pre-view image by icon only .
- Abnormal files are displayed in the form of bitmap .
- A damaged or corrupted music does not play but displays 00:00 in playtime.
- A music downloaded from a paid service with copyright protection does not start but displays inappropriate information in playtime.
- If you press OK, , screen saver is stopped.
- The PLAY() , Pause() , , ,  buttons on the remote control are also available in this mode.
- You can use the  button to select the next music and the  button to select the previous music.



### Music options

- 1 Press **Q. MENU** to access the **Pop-Up** menus.
- 2 Press the Navigation buttons to scroll to **Set Audio Play.** or **Set Audio.** and press **OK.**

### ! NOTE

- Option values changed in **Movie List** does not affect **Photo List** and **Music List.**
- Option value changed in **Photo List** and **Music List** are changed likewise in **Photo List** and **Music List** excluding **Movie List.**

When you select the **Set Audio Play.**

- 1 Press the Navigation buttons to scroll to select the **Repeat** or **Random.**
- 2 Press the Navigation buttons to scroll to make appropriate adjustments.

When you select the **Set Audio.**

- 1 Press the Navigation buttons to scroll to select the **Sound Mode, Auto Volume, Clear Voice II** or **Balance.**
- 2 Press the Navigation buttons to scroll to make appropriate adjustments.(See p.72)

## DivX® VOD Guide

### DivX® VOD Registration

In order to play purchased or rented DivX® VOD contents, you should register your device with 10 digit DivX registration code from your device at [www.divx.com/vod](http://www.divx.com/vod).

- 1 Press **SETTINGS** to access the main menus.
- 2 Press the Navigation buttons to scroll to **MY MEDIA** and press **OK**.
- 3 Press the Blue button.
- 4 Press the Navigation buttons to scroll to **DivX VOD Registration** and press **OK**.
- 5 View the registration code of your TV.

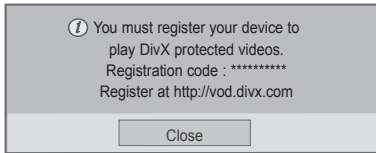

- 6 When you are finished, press **EXIT**. When you return to the previous menu, press **↶**.

### ! NOTE

- Movie files are supported as follows  
**Resolution** : under 1920x1080 WxH pixels  
**Frame rate** : under 30 frames/sec(1920x1080), under 60 frames/sec(under 1280x720)
- Video Codec : MPEG 1, MPEG 2, MPEG 4, H.264/AVC, DivX 3.11, DivX 4.12, DivX 5.x, DivX 6, Xvid 1.00, Xvid 1.01, Xvid 1.02, Xvid 1.03, Xvid 1.10-beta1, Xvid 1.10-beta2, JPEG, VC1, Sorenson H.263/H.264.

### DivX® VOD Deregistration

You should deregister your device with 8 digit DivX deregistration code from your device at [www.divx.com/vod](http://www.divx.com/vod).

- 1 Press **SETTINGS** to access the main menus.
- 2 Press the Navigation buttons to scroll to **MY MEDIA** and press **OK**.
- 3 Press the Blue button.
- 4 Press the Navigation buttons to scroll to **DivX Deregistration** and press **OK**.
- 5 Press the Navigation buttons to select **Yes** to confirm.

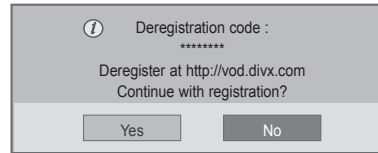

- 6 When you are finished, press **EXIT**. When you return to the previous menu, press **↶**.

### ! NOTE

- Once the deregistration is executed, you must register your device again to see DivX® VOD contents.

# CUSTOMIZING TV SETTING

- Image shown may differ from your TV.

## Accessing main menus

- 1 Press **SETTINGS** to access the main menus.
- 2 Press the Navigation buttons to scroll to one of the following menus and press **OK**.
- 3 Press Navigation buttons to scroll to the setting or option you want and press **OK**.
- 4 When you are finished, press **EXIT**.

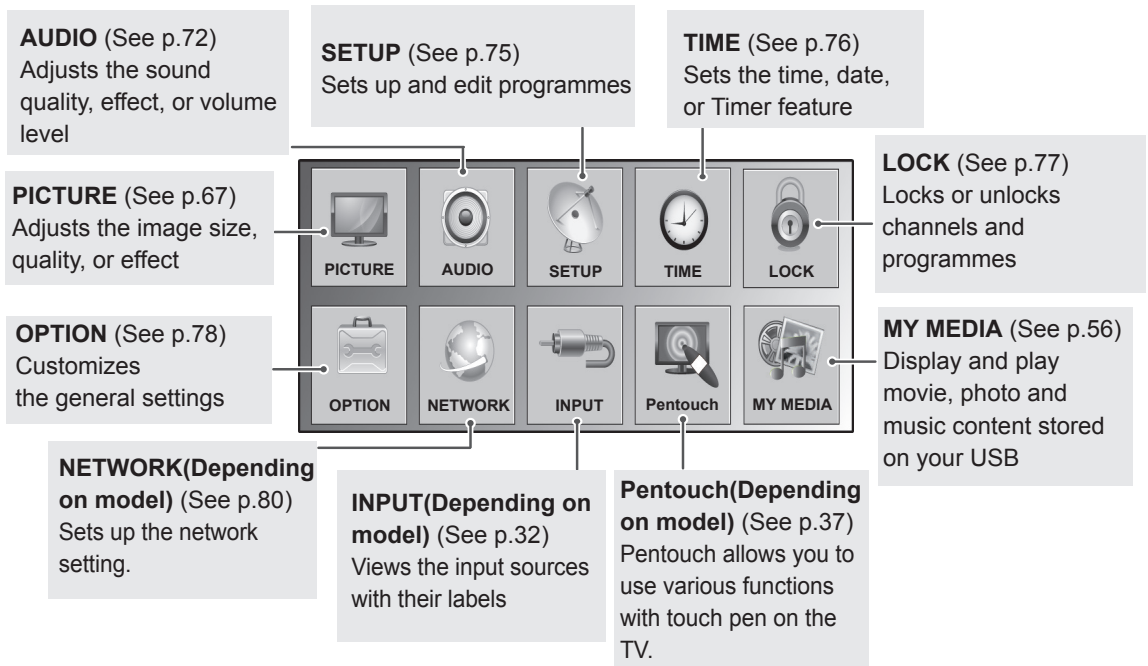

## Customizing settings

- Image shown may differ from your TV.

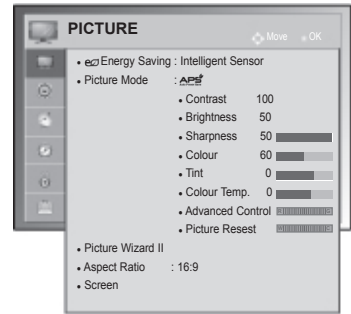

### PICTURE settings

- 1 Press **SETTINGS** to access the main menus.
- 2 Press the Navigation buttons to scroll to **PICTURE** and press **OK**.
- 3 Press the Navigation buttons to scroll to the setting or option you want and press **OK**.
  - To return to the previous level, press ↶.
- 4 When you are finished, press **EXIT**.



The available picture settings are described in the following.

Setting	Description	
<b>Energy Saving</b>	Reduces the power consumption by adjusting the screen brightness.	
	<b>Option</b>	
	Intelligent sensor	*This feature is not available for all models. The most suitable brightness is automatically adjusted according to the surrounding conditions.
	Off	The <b>Energy Saving</b> is off.
	Minimum/Medium/Maximum	Selects the brightness level.
	Screen off	The screen turns off in 3 seconds.
<div style="border: 1px solid black; padding: 10px;"> <p><b>NOTE</b></p> <ul style="list-style-type: none"> <li>• When you select <b>Screen Off</b>, the screen will be turned off in 3 seconds and <b>Screen Off</b> will start.</li> <li>• If you adjust “<b>Energy Saving-Intelligent Sensor</b>”, <b>Sharpness</b>, <b>Colour</b>, <b>Colour Temperature</b> feature will not work.</li> </ul> </div>		
<b>Picture Mode</b>	Selects one of the preset image or customizes options in each mode for the best TV screen performance. You are also able to customize advanced options of each mode. The available preset picture modes vary depending on the TV.	
	<b>Mode</b>	
	Vivid	Adjusts the video image for the retail environment by enhancing the contrast, brightness, colour, and sharpness.
	Standard	Adjusts the image for the normal environment.
	APF	Optimizes power consumption.
	Cinema	Optimizes the video image for a cinematic look to enjoy movies as if you are in a movie theater.
	Game	Optimizes the video image for a fast gaming screen such as PCs or games.
	Expert1,2	Adjusts the detailed video image settings for video experts as well as general viewers.

Setting	Description														
	<p> <b>NOTE</b></p> <ul style="list-style-type: none"> <li>• <b>Picture Mode</b> adjusts the TV for the best picture appearance. Select the preset value in the <b>Picture Mode</b> menu based on the programme category.</li> <li>• When the Intelligent sensor function is on, the most suitable picture is automatically adjusted according to the surrounding conditions.</li> <li>• You can also adjust <b>Picture Mode</b> in the <b>Q. Menu</b>.</li> <li>• <b>APSR</b> (Auto Power Saving) : Maximize reducing the power consumption without hurting the picture quality.</li> <li>• If you adjust "<b>Picture Mode</b>-<b>Energy Saving-Intelligent Sensor, Minimum, Medium, Maximum</b>" feature will not work.</li> <li>• If you adjust "<b>Picture Mode</b>-<b>APSR</b>", "<b>Energy Saving-Off, Minimum, Medium, Maximum</b>" feature will not work.</li> </ul>														
<b>Picture Wizard II</b>	<p>Adjusts the image quality and calibrates the screen by following the on-screen instructions. The customized options will be saved as <b>Expert1</b> in the <b>Picture Mode</b>.</p> <table border="1" data-bbox="323 672 1266 836"> <tr> <td data-bbox="323 672 522 755">Standard</td> <td data-bbox="522 672 1266 755">Mode to set standard picture quality. (<b>Black Level, White Level, Tint, Colour, Horizontal Sharpness, Vertical Sharpness</b>)</td> </tr> <tr> <td data-bbox="323 755 522 836">Preferred</td> <td data-bbox="522 755 1266 836">Mode to set user preferred picture quality rather than standard picture. (<b>Black Level, White Level, Tint, Sharpness, Dynamic Contrast, Colour Temperature</b>)</td> </tr> </table> <p> <b>NOTE</b></p> <ul style="list-style-type: none"> <li>• If you stop the setting before the final stage, the changes will not be applied.</li> <li>• If you use <b>Picture Wizard II</b>, the Energy saving feature will turn off automatically.</li> <li>• To reset changes made by <b>Picture Wizard II</b>, operate <b>Picture Reset</b> when <b>Picture Mode</b> is on <b>Expert1</b>.</li> <li>• In RGB-PC/HDMI-PC/DVI-PC mode, the changed <b>Colour, Tint</b> and <b>H/V Sharpness</b> values are not applied.</li> </ul>	Standard	Mode to set standard picture quality. ( <b>Black Level, White Level, Tint, Colour, Horizontal Sharpness, Vertical Sharpness</b> )	Preferred	Mode to set user preferred picture quality rather than standard picture. ( <b>Black Level, White Level, Tint, Sharpness, Dynamic Contrast, Colour Temperature</b> )										
Standard	Mode to set standard picture quality. ( <b>Black Level, White Level, Tint, Colour, Horizontal Sharpness, Vertical Sharpness</b> )														
Preferred	Mode to set user preferred picture quality rather than standard picture. ( <b>Black Level, White Level, Tint, Sharpness, Dynamic Contrast, Colour Temperature</b> )														
<b>Aspect Ratio</b>	Changes the image size to view images at its optimal size (See p.30).														
<b>SCREEN</b>	<p>Customizes the PC display options.</p> <table border="1" data-bbox="323 1213 1266 1489"> <thead> <tr> <th colspan="2" data-bbox="323 1213 1266 1251"><b>Option</b></th> </tr> </thead> <tbody> <tr> <td data-bbox="323 1251 522 1290">Resolution</td> <td data-bbox="522 1251 1266 1290">Selects a proper resolution when your PC uses.</td> </tr> <tr> <td data-bbox="323 1290 522 1329">Auto Configure</td> <td data-bbox="522 1290 1266 1329">Sets the TV to optimize the options automatically for the TV display.</td> </tr> <tr> <td data-bbox="323 1329 522 1367">Position</td> <td data-bbox="522 1329 1266 1367">Locates the image at the proper position.</td> </tr> <tr> <td data-bbox="323 1367 522 1406">Size</td> <td data-bbox="522 1367 1266 1406">Adjusts the image size.</td> </tr> <tr> <td data-bbox="323 1406 522 1445">Phase</td> <td data-bbox="522 1406 1266 1445">Eliminates horizontal streaking.</td> </tr> <tr> <td data-bbox="323 1445 522 1489">Reset</td> <td data-bbox="522 1445 1266 1489">Restores the options to the default setting.</td> </tr> </tbody> </table>	<b>Option</b>		Resolution	Selects a proper resolution when your PC uses.	Auto Configure	Sets the TV to optimize the options automatically for the TV display.	Position	Locates the image at the proper position.	Size	Adjusts the image size.	Phase	Eliminates horizontal streaking.	Reset	Restores the options to the default setting.
<b>Option</b>															
Resolution	Selects a proper resolution when your PC uses.														
Auto Configure	Sets the TV to optimize the options automatically for the TV display.														
Position	Locates the image at the proper position.														
Size	Adjusts the image size.														
Phase	Eliminates horizontal streaking.														
Reset	Restores the options to the default setting.														

## Basic image options

Setting	Description
<b>Contrast</b>	Increases or decreases the gradient of the video signal. You may use <b>Contrast</b> when the bright part of the picture is saturated.
<b>Brightness</b>	Adjusts the base level of the signal in the picture.
<b>Sharpness</b>	Adjusts the level of crispness in the edges between the light and dark areas of the picture. The lower the level, the softer the image.
<b>Colour</b>	Adjusts intensity of all colours.
<b>Tint</b>	Adjusts the balance between red and green levels.
<b>Colour Temp.</b>	Set to warm to enhance hotter colours such as red, or set to cool to enhance cooler colours such as blue.
<b>Advanced Control or Expert Control</b>	Customizes the advanced options
<b>Picture Reset</b>	Restores the options of each mode to the factory default

 **NOTE**

- You cannot adjust colour, sharpness and tint in the RGB-PC/HDMI-PC mode.

## Advanced image options

Setting	Description
<b>Dynamic Contrast</b>	Adjusts the contrast to keep it at the best level according to the brightness of the screen. The picture is improved by making bright parts brighter and dark parts darker.
<b>Noise Reduction</b>	Reduces screen noise without compromising video quality.
<b>Gamma</b>	You can adjust brightness of dark area and middle gray level area of the picture. <ul style="list-style-type: none"> <li>» Low: Make the dark and middle gray level areas brighter.</li> <li>» Medium: Express the original picture level.</li> <li>» High: Make the dark and middle gray level area darker.</li> </ul>
<b>Black Level</b>	Sets black level of the screen to proper level. This function is available in the following modes: AV (NTSC-M), HDMI, Component or USB <ul style="list-style-type: none"> <li>» Low: The reflection of the screen gets darker.</li> <li>» High: The reflection of the screen gets brighter.</li> <li>» Auto : Sets black level of the screen to High or Low automatically according to the input signal level.</li> </ul>
<b>Film Mode</b>	Makes video clips recorded in film look more natural by eliminating judder effect. DVD and Blu-ray movies are filmed at 24 frames per second (fps).
<b>Colour Gamut</b>	<b>Advanced Control</b> Maximizes the utilization of colour to increase colour quality. <ul style="list-style-type: none"> <li>» Standard: Displays standard set of colours.</li> <li>» Wide: Increase number of colours used.</li> </ul>
	<b>Expert Control</b> Displays colour domain of the signal. <ul style="list-style-type: none"> <li>» Standard: Displays standard set of colours.</li> <li>» Wide: Increase number of colours used.</li> </ul>
<b>Edge Enhancer</b>	Shows clearer and distinctive yet natural edges of the video.
<b>XVYCC</b> (available in Cinema and Expert modes)	*This feature is not available for all models. This is the function to express richer colours. This feature represents rich colours as much as a conventional video signal. This function is enabled in " <b>Picture Mode - Cinema, Expert</b> " when xvYCC signal is inputted through HDMI.
<b>Expert Pattern</b> (available in Cinema and Expert modes)	This is the pattern necessary for expert adjustment. This function is enabled in " <b>Picture Mode - Cinema, Expert</b> " when you watch DTV.
<b>Colour Filter</b>	This is the function to filter the specific colours of the video. You can use the RGB filter to set colour saturation and hue accurately.

## Advanced image options

Setting	Description		
<b>Colour Temperature</b>	<p>Adjusts the overall color of the screen by changing the white baseline.</p> <table border="0" data-bbox="333 301 1232 527"> <tr> <td data-bbox="333 301 755 527"> <p>a. Method : 2 Points</p> <ul style="list-style-type: none"> <li>• Pattern: Inner, Outer</li> <li>• Point : High/Low</li> <li>• Red/Green/Blue: The adjustment range is -50 to +50.</li> </ul> </td> <td data-bbox="755 301 1232 527"> <p>b. Method : 20 Point IRE</p> <ul style="list-style-type: none"> <li>• IRE (Institute of Radio Engineers) is the unit to display the size of the video signal and can be set among 5, 10, 15 to 100 Plasma TV. You can adjust Red, Green or Blue according to each setting.</li> <li>• Red/Green/Blue: The adjustment range is -50 to +50.</li> </ul> <p>c. Apply to all inputs</p> </td> </tr> </table>	<p>a. Method : 2 Points</p> <ul style="list-style-type: none"> <li>• Pattern: Inner, Outer</li> <li>• Point : High/Low</li> <li>• Red/Green/Blue: The adjustment range is -50 to +50.</li> </ul>	<p>b. Method : 20 Point IRE</p> <ul style="list-style-type: none"> <li>• IRE (Institute of Radio Engineers) is the unit to display the size of the video signal and can be set among 5, 10, 15 to 100 Plasma TV. You can adjust Red, Green or Blue according to each setting.</li> <li>• Red/Green/Blue: The adjustment range is -50 to +50.</li> </ul> <p>c. Apply to all inputs</p>
<p>a. Method : 2 Points</p> <ul style="list-style-type: none"> <li>• Pattern: Inner, Outer</li> <li>• Point : High/Low</li> <li>• Red/Green/Blue: The adjustment range is -50 to +50.</li> </ul>	<p>b. Method : 20 Point IRE</p> <ul style="list-style-type: none"> <li>• IRE (Institute of Radio Engineers) is the unit to display the size of the video signal and can be set among 5, 10, 15 to 100 Plasma TV. You can adjust Red, Green or Blue according to each setting.</li> <li>• Red/Green/Blue: The adjustment range is -50 to +50.</li> </ul> <p>c. Apply to all inputs</p>		
<b>Colour Management System</b>	<p>As the tool used by the experts to make adjustments by using the test patterns, this does not affect other colours but can be used to selectively adjust the 6 colour areas (Red/Green/Blue/Cyan/Magenta/Yellow). Colour difference may not be distinctive even when you make the adjustments for the general video. Adjusts Red/Green/Blue/Yellow/Cyan, Magenta. Red/Green/Blue/Yellow/Cyan, Magenta Colour: The adjustment range is -30 to +30. Red/Green/Blue/Yellow/Cyan, Magenta Tint: The adjustment range is -30 to +30. This feature is disable in RGB-PC and HDMI-PC mode.</p>		

## AUDIO settings

- Image shown may differ from your TV.

- 1 Press **SETTINGS** to access the main menus.
- 2 Press the Navigation buttons to scroll to **AUDIO** and press **OK**.
- 3 Press the Navigation buttons to scroll to the setting or option you want and press **OK**.
  - To return to the previous level, press ↶.
- 4 When you are finished, press **EXIT**.

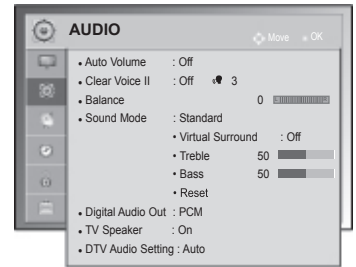

The available audio settings are described in the following.

(Depending on model)

Setting	Description
<b>Auto Volume</b>	Activates the Auto Volume feature to keep the volume level consistent whenever you change channels. The volume level may not be consistent due to different signal conditions of broadcasting stations.
<b>Clear Voice II</b>	<p>Sets whether to enhance human voice clarity. You can adjust the level of clarity when you set this feature on.</p> <div style="border: 1px solid black; padding: 5px; margin-top: 10px;"> <p><b>NOTE</b></p> <ul style="list-style-type: none"> <li>• If you select "On" for <b>Clear Voice II</b>, <b>Virtual Surround</b> feature will not work.</li> <li>• Select levels from '-6' to '+6'.</li> </ul> </div>
<b>Balance</b>	Adjust balance between the left and right speakers according to your room environment.
<b>Sound Mode</b>	Selects one of the preset sound modes or customizes options in each mode.
	<b>Mode</b>
	Standard Select when you want standard-quality sound.
	Music Select when you listen to music.
	Cinema Select when you watch movies.
	Sport Select when you watch sports events.
	Game Select when you play games.
	<b>Option</b>
	Virtual Surround <b>Virtual Surround</b> is a patented LG proprietary sound processing technology that strives immersive 5.1 surround sound impression with front two loudspeakers.
	Treble Controls the dominant sounds in the output. When you turn up the treble, it will increase the output to the higher frequency range.
	Bass Controls the softer sounds in the output. When you turn up the bass, it will increase the output to the lower frequency range.
	Reset Resets the sound mode to the default setting.

Setting	Description								
<b>Digital Audio Out</b>	This function allows you to select your preferred Digital Audio Output. When Dolby Digital is available, selecting Auto in the Digital Audio Out menu will set SPDIF(Sony Philips Digital InterFace) output to Dolby Digital. If Auto is selected in the digital audio out menu when Dolby Digital is not available, SPDIF output will be PCM(Pulse-code modulation). Even if both Dolby Digital and Audio language have been set in a channel which broadcast Dolby Digital Audio, only Dolby Digital will be played.								
	<b>Item</b>	<b>Audio Input</b>	<b>Digital Audio output</b>						
	Auto	MPEG Dolby Digital Dolby Digital Plus Pulse	PCM Dolby Digital Dolby Digital Dolby Digital						
	PCM	All	PCM						
<b>TV Speaker</b>	Turns on the internal speaker of the TV when using an external Hi-Fi system. You can use the TV speaker as an audio output device even if there is no video input. <div style="border: 1px solid black; padding: 10px; margin-top: 10px;"> <p> <b>NOTE</b></p> <ul style="list-style-type: none"> <li>When the <b>TV speaker</b> is turned off while the Simplink home theater is operating, the sound output automatically switches to the Home theater speaker, but when the <b>TV speaker</b> is turned on, the sound output the <b>TV speaker</b>.</li> <li>Some menus in <b>AUDIO</b> are disabled when <b>TV Speaker</b> is set to <b>Off</b>.</li> </ul> </div>								
<b>DTV Audio Setting</b> (In Digital Mode only)	When different audio types exist in an input signal, this function allows you to select the audio type you want. <table border="1" style="width: 100%; border-collapse: collapse;"> <thead> <tr> <th data-bbox="271 956 459 987" style="background-color: #f2f2f2;">Mode</th> <th data-bbox="459 956 1232 987"></th> </tr> </thead> <tbody> <tr> <td data-bbox="271 987 459 1290">                             Auto                         </td> <td data-bbox="459 987 1232 1290">                             Automatically outputs in the order <b>HE-AAC &gt; Dolby Digital+ &gt; Dolby Digital &gt; MPEG</b>.(Except for Denmark,Finland,Hungary,Italy,Latvia,Lithuania,Norway,Sweden)                              Automatically outputs in the order <b>HE-AAC &gt; Dolby Digital+ &gt; MPEG &gt; Dolby Digital</b>.(Only Italy,Latvia,Lithuania)                              Automatically outputs in the order <b>Dolby Digital+ &gt; Dolby Digital &gt; HE-AAC &gt; MPEG</b>.(Only Hungary)                              If Digital Audio Out is set to PCM, automatically outputs in the order <b>MPEG &gt; HE-AAC &gt; Dolby Digital+ &gt; Dolby Digital</b>.(Only Denmark,Finland,Norway,Sweden)                              If Digital Audio Out is set to Auto, automatically outputs in the order <b>Dolby Digital+ &gt; Dolby Digital &gt; HE-AAC &gt; MPEG</b>.(Only Denmark,Finland,Norway,Sweden)                         </td> </tr> <tr> <td data-bbox="271 1290 459 1373">                             HE-AAC, Dolby Digital+, Dolby Digital, MPEG                         </td> <td data-bbox="459 1290 1232 1373">                             Allows users to select the audio type they want.                              ex) If <b>MPEG</b> is selected, <b>MPEG</b> is always outputted.                              If MPEG is not supported, another audio type is set in that order.                         </td> </tr> </tbody> </table> <p style="text-align: right; margin-top: 10px;">See p.78 (Audio Language Selection)</p>			Mode		Auto	Automatically outputs in the order <b>HE-AAC &gt; Dolby Digital+ &gt; Dolby Digital &gt; MPEG</b> .(Except for Denmark,Finland,Hungary,Italy,Latvia,Lithuania,Norway,Sweden) Automatically outputs in the order <b>HE-AAC &gt; Dolby Digital+ &gt; MPEG &gt; Dolby Digital</b> .(Only Italy,Latvia,Lithuania) Automatically outputs in the order <b>Dolby Digital+ &gt; Dolby Digital &gt; HE-AAC &gt; MPEG</b> .(Only Hungary) If Digital Audio Out is set to PCM, automatically outputs in the order <b>MPEG &gt; HE-AAC &gt; Dolby Digital+ &gt; Dolby Digital</b> .(Only Denmark,Finland,Norway,Sweden) If Digital Audio Out is set to Auto, automatically outputs in the order <b>Dolby Digital+ &gt; Dolby Digital &gt; HE-AAC &gt; MPEG</b> .(Only Denmark,Finland,Norway,Sweden)	HE-AAC, Dolby Digital+, Dolby Digital, MPEG	Allows users to select the audio type they want. ex) If <b>MPEG</b> is selected, <b>MPEG</b> is always outputted. If MPEG is not supported, another audio type is set in that order.
Mode									
Auto	Automatically outputs in the order <b>HE-AAC &gt; Dolby Digital+ &gt; Dolby Digital &gt; MPEG</b> .(Except for Denmark,Finland,Hungary,Italy,Latvia,Lithuania,Norway,Sweden) Automatically outputs in the order <b>HE-AAC &gt; Dolby Digital+ &gt; MPEG &gt; Dolby Digital</b> .(Only Italy,Latvia,Lithuania) Automatically outputs in the order <b>Dolby Digital+ &gt; Dolby Digital &gt; HE-AAC &gt; MPEG</b> .(Only Hungary) If Digital Audio Out is set to PCM, automatically outputs in the order <b>MPEG &gt; HE-AAC &gt; Dolby Digital+ &gt; Dolby Digital</b> .(Only Denmark,Finland,Norway,Sweden) If Digital Audio Out is set to Auto, automatically outputs in the order <b>Dolby Digital+ &gt; Dolby Digital &gt; HE-AAC &gt; MPEG</b> .(Only Denmark,Finland,Norway,Sweden)								
HE-AAC, Dolby Digital+, Dolby Digital, MPEG	Allows users to select the audio type they want. ex) If <b>MPEG</b> is selected, <b>MPEG</b> is always outputted. If MPEG is not supported, another audio type is set in that order.								

**Stereo/Dual Reception (In Analogue Mode Only)**

When a programme is selected, the sound information for the station appears with the programme number and station name.

- 1 Press **Q. MENU** and press the Navigation to access the **Audio** or **Audio Language** and press **OK**.
- 2 Press the Navigation button to scroll to the sound output and press **OK**.

Broadcast	On Screen Display
Mono	MONO
Stereo	STEREO
Dual	DUAL I , DUAL II , DUAL I + II

- **Mono sound selection**

If the stereo signal is weak in stereo reception, you can switch to mono. In mono reception, the clarity of sound is improved.

- **Language selection for dual language broadcast**

If a programme can be received in two languages (dual language), you can switch to DUAL I, DUAL II or DUAL I+II.

<b>DUAL I</b>	Sends the primary broadcast language to the loudspeakers.
<b>DUAL II</b>	Sends the secondary broadcast language to the loudspeakers.
<b>DUAL I+II</b>	Sends a separate language to each loudspeaker.

**Nicam Reception (In Analogue Mode Only)**

If the TV is equipped with a receiver for NICAM reception, high quality NICAM (Near Instantaneous Companding Audio Multiplex) digital sound can be received.

Sound output can be selected according to the type of broadcast received.

- 1 When **NICAM** mono is received, you can select **NICAM MONO** or **FM MONO**.
- 2 When **NICAM** stereo is received, you can select **NICAM STEREO** or **FM MONO**.  
If the stereo signal is weak, switch to **FM MONO**.
- 3 When **NICAM** dual is received, you can select **NICAM DUAL I**, **NICAM DUAL II** or **NICAM DUAL I+II** or **FM MONO**.

**Speaker Sound Output Selection**

In AV, Component, RGB and HDMI mode, you can select output sound for the left and right loudspeakers. Select the sound output.

**L+R:** Audio signal from audio L input is sent to the left loudspeaker and audio signal from audio R input is sent to the right loudspeaker.

**L+L:** Audio signal from audio L input is sent to left and right loudspeakers.

**R+R:** Audio signal from audio R input is sent to left and right loudspeakers.

## SETUP settings

- Image shown may differ from your TV.

- 1 Press **SETTINGS** to access the main menus.
- 2 Press the Navigation buttons to scroll to **SETUP** and press **OK**.
- 3 Press the Navigation buttons to scroll to the setting or option you want and press **OK**.
  - To return to the previous level, press ↶.
- 4 When you are finished, press **EXIT**.



The available Programme settings are described in the following:

Setting	Description
<b>Auto Tuning</b>	Tunes and stores all available programmes through antennas or cable inputs (See p.20).
<b>Manual Tuning</b>	Tunes and stores the programmes you want manually (See p.22).
<b>Programme Edit</b>	Edits programmes. (See p.24).
<b>CI information</b>	Enables you to watch some encrypted services (pay services).(See p.26).
<b>Cable DTV Setting</b> (In Cable mode only)	The range that a user can select from the <b>Service Operator</b> menu differs depending on number of <b>Service Operator</b> supported by each country, and if number of supported <b>Service Operator</b> for each country is 1, corresponding function becomes non-activation. After changing <b>Service Operator</b> , a warning window saying that channel map will be deleted when OK button is pressed or <b>Close</b> is selected, and a Auto-tuning pop-up window appears when 'YES' is selected.(See p.22).

## TIME settings

- Image shown may differ from your TV.

- 1 Press **SETTINGS** to access the main menus.
- 2 Press the Navigation buttons to scroll to **TIME** and press **OK**.
- 3 Press the Navigation buttons to scroll to the setting or option you want and press **OK**.
  - To return to the previous level, press ↶.
- 4 When you are finished, press **EXIT**.

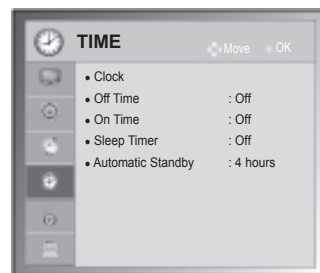

The available time settings are described in the following.

Setting	Description												
<b>Clock</b>	<p>Sets the time, date, time zone, and daylight-saving time feature. The time will be set automatically according to a digital channel signal which includes time information provided by the broadcasting station. If not, set the time and date manually.</p> <div style="border: 1px solid gray; padding: 10px; margin: 10px 0;"> <p><b>NOTE</b></p> <ul style="list-style-type: none"> <li>• The TV time is set by the time offset information based on Time Zone and GMT (Greenwich Mean Time) which is received with the broadcast signal and the time is set automatically by a digital signal.</li> <li>• When if the city name in Time Zone is changed into offset, you can change time by 1 hour.</li> <li>• <b>Time Zone</b> menu can be changed in <b>Auto</b> mode.</li> </ul> </div> <table border="1" style="width: 100%; border-collapse: collapse;"> <thead> <tr> <th style="text-align: left;">Time Zone</th> <th style="text-align: left;">Description</th> </tr> </thead> <tbody> <tr> <td>Magadan, Kamchatka</td> <td rowspan="9">           This Table means the Time Zone table of 9 area of Russia, and when the user selects the Time Zone for his or her area, it automatically sets the time for the corresponding area.             However, even though the user selected his or her area, if the broadcasting station's local time offset is not offered, or if the region information does not match, then the user may select the Offset from the Time Zone to set the correct time.         </td> </tr> <tr><td>Vladivostok</td></tr> <tr><td>Yakutsk</td></tr> <tr><td>Irkutsk</td></tr> <tr><td>Krasnoyarsk</td></tr> <tr><td>Omsk</td></tr> <tr><td>Yekaterinburg</td></tr> <tr><td>Moscow, Samara</td></tr> <tr><td>Kaliningrad</td></tr> </tbody> </table>	Time Zone	Description	Magadan, Kamchatka	This Table means the Time Zone table of 9 area of Russia, and when the user selects the Time Zone for his or her area, it automatically sets the time for the corresponding area.  However, even though the user selected his or her area, if the broadcasting station's local time offset is not offered, or if the region information does not match, then the user may select the Offset from the Time Zone to set the correct time.	Vladivostok	Yakutsk	Irkutsk	Krasnoyarsk	Omsk	Yekaterinburg	Moscow, Samara	Kaliningrad
Time Zone	Description												
Magadan, Kamchatka	This Table means the Time Zone table of 9 area of Russia, and when the user selects the Time Zone for his or her area, it automatically sets the time for the corresponding area.  However, even though the user selected his or her area, if the broadcasting station's local time offset is not offered, or if the region information does not match, then the user may select the Offset from the Time Zone to set the correct time.												
Vladivostok													
Yakutsk													
Irkutsk													
Krasnoyarsk													
Omsk													
Yekaterinburg													
Moscow, Samara													
Kaliningrad													

Setting	Description
<b>Off Time/On Time</b>	<p>Sets the time to turn on or off the TV automatically. To use this function, you should set the current time and date in advance.</p> <p><b>NOTE</b></p> <ul style="list-style-type: none"> <li>If you do not press any button within 2 hours after the TV turns on by the On Time feature, the TV enters the Standby mode automatically.</li> <li>If you set both Off time and On time features to the same time, the Off time feature overrides the On time feature.</li> </ul>
<b>Sleep Timer</b>	<p>Sets the length of time until the TV to turns off. When you turn the TV off and turn it on again, the Sleep timer feature will be set to off.</p>
<b>Automatic Standby (Depending on model)</b>	<p>If you do not press any button when Automatic Standby function is on, the TV automatically switches to the standby mode.</p> <p><b>NOTE</b></p> <ul style="list-style-type: none"> <li>This function does not work on Store Demo mode or while software update.</li> </ul>

## LOCK settings

• Image shown may differ from your TV.

- 1 Press **SETTINGS** to access the main menus.
- 2 Press the Navigation buttons to scroll to **LOCK** and press **OK**.
- 3 Press the Navigation buttons to scroll to the setting or option you want and press **OK**.
  - To return to the previous level, press ↶.
- 4 When you are finished, press **EXIT**.

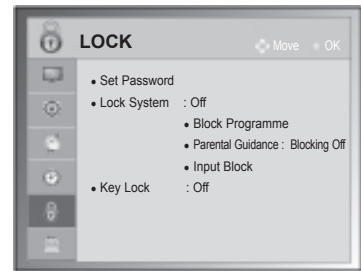

ENGLISH

The available lock settings are described in the following.

Setting	Description
<b>Set Password</b>	<p>Changes the 4-digit password. The default PIN is "0 0 0 0".                      When France is selected for Country, password is not '0','0','0','0' but '1','2','3','4'.                      When France is selected for Country, password cannot be set as '0','0','0','0'.                      If you forget your password, press '0', '3', '2', '5' on the remote control handset.</p>
<b>Lock System</b>	<p>Activates or deactivates the lock system.</p>
<b>Block Programme</b>	<p>Blocks the programmes that contain inappropriate contents for children by pressing the Green button. The Lock icon appears in front of the blocked programmes. The programmes can be selected but the screen blank and the audio is muted.                      To watch a locked channel, enter the password.                      It is available to use this function in <b>Lock System "On"</b></p>
<b>Parental Guidance (In Digital Mode only)</b>	<p>This function operates according to information from the broadcasting station. Therefore if the signal has incorrect information, this function does not operate.                      A password is required to gain access to this menu.                      This set is programmed to remember which option it was last set to even if you switch the set off.                      Prevents children from watching certain adult's TV programmes, according to the ratings limit set.                      Enter a password to watch a blocked programme.                      Rating differs by country.</p>
<b>Input Block</b>	<p>Block the input sources.                      It is available to use this function in <b>Lock System "On"</b></p>
<b>Key Lock</b>	<p>Locks or unlocks the buttons on the TV.</p>

## OPTION settings

• Image shown may differ from your TV.



- 1 Press **SETTINGS** to access the main menus.
- 2 Press the Navigation buttons to scroll to **OPTION** and press **OK**.
- 3 Press the Navigation buttons to scroll to the setting or option you want and press **OK**.  
- To return to the previous level, press **↶**.
- 4 When you are finished, press **EXIT**.



The available general settings are described in the following.

(Depending on model)

Setting	Description																
<b>Language</b>	Selects a language for the display or audio.																
<b>Option</b>																	
Menu Language	Select your desired language.																
Audio Language (In Digital mode Only)	The Audio function allows selection of a preferred language. If audio data in a selected language is not broadcast, the default language audio will be played. <b>Audio Language OSD Information</b>																
	<table border="1"> <thead> <tr> <th>Display</th> <th>Status</th> </tr> </thead> <tbody> <tr> <td>N.A</td> <td>Not Available</td> </tr> <tr> <td> MPEG</td> <td>MPEG Audio</td> </tr> <tr> <td> D</td> <td>Dolby Digital Audio</td> </tr> <tr> <td> D+</td> <td>Dolby Digital Plus Audio</td> </tr> <tr> <td></td> <td>Audio for "Visual Impaired"</td> </tr> <tr> <td></td> <td>Audio for "Hearing Impaired"</td> </tr> <tr> <td></td> <td>HE-AAC Audio</td> </tr> </tbody> </table>	Display	Status	N.A	Not Available	MPEG	MPEG Audio	D	Dolby Digital Audio	D+	Dolby Digital Plus Audio		Audio for "Visual Impaired"		Audio for "Hearing Impaired"		HE-AAC Audio
Display	Status																
N.A	Not Available																
MPEG	MPEG Audio																
D	Dolby Digital Audio																
D+	Dolby Digital Plus Audio																
	Audio for "Visual Impaired"																
	Audio for "Hearing Impaired"																
	HE-AAC Audio																
Subtitle Language (In Digital mode Only)	Use the Subtitle function when two or more subtitle languages are broadcast. If subtitle data in a selected language is not broadcast, the default language subtitle will be displayed. <b>Subtitle Language OSD Information</b>																
	<table border="1"> <thead> <tr> <th>Display</th> <th>Status</th> </tr> </thead> <tbody> <tr> <td>N.A</td> <td>Not Available</td> </tr> <tr> <td> TXT</td> <td>Teletext Subtitle</td> </tr> <tr> <td></td> <td>Subtitle for "Hard of Hearing"</td> </tr> </tbody> </table>	Display	Status	N.A	Not Available	TXT	Teletext Subtitle		Subtitle for "Hard of Hearing"								
Display	Status																
N.A	Not Available																
TXT	Teletext Subtitle																
	Subtitle for "Hard of Hearing"																
Text Language (In Digital mode Only)	In Digital mode, use the Text language function when two or more Text languages are broadcast. If teletext data in a selected language is not broadcast, the default Text language page will be displayed.																
<b>NOTE</b>	<ul style="list-style-type: none"> <li>• When the languages you selected as the primary for Audio Language and Subtitle Language and Text Language are not supported, you can select language in secondary category.</li> <li>• The audio/subtitles can be displayed in a simpler form with 1 to 3 characters broadcast by the service provider.</li> <li>• When you select supplementary Audio (Audio for "Visual/Hearing Impaired") the TV may output a part of the Main audio.</li> </ul>																

Setting	Description										
<b>Country</b>	<p>Selects a desired country.</p> <div style="border: 1px solid black; padding: 10px; margin-top: 10px;"> <p> <b>NOTE</b></p> <ul style="list-style-type: none"> <li>If you do not finish the set-up Installation Guide by pressing  or if you time out on the OSD (On Screen Display) the installation menu will continuously appear until the set up is completed whenever the TV is switched on.</li> <li>If you select the wrong local country, teletext may not appear correctly on the screen and some problems may occur during teletext operation.</li> <li>The CI (Common Interface) function may not be applied based on country broadcasting circumstances.</li> <li>DTV mode control buttons may not function based on country broadcasting circumstances.</li> <li>In country that Digital broadcasting regulation isn't fixed, some DTV function may not work depending on digital broadcasting circumstances.</li> <li>The Country Setting "UK" should only be activated in UK.</li> <li>If the country setting is set to "--", European terrestrial digital standard broadcasting programmes are available, but some DTV functions may not work properly.</li> </ul> </div>										
<b>Disabled Assistance</b> (In Digital Mode only)	<table border="1" style="width: 100%; border-collapse: collapse;"> <thead> <tr> <th colspan="2" data-bbox="303 703 1225 734">Option</th> </tr> </thead> <tbody> <tr> <td data-bbox="303 734 554 765">Hard of Hearing</td> <td data-bbox="554 734 1225 765">This function is for the hearing impaired.</td> </tr> <tr> <td data-bbox="303 765 554 1010" rowspan="3">Audio Description</td> <td data-bbox="554 765 1225 919">This function is for the blind, and provides explanatory audio describing the current situation in a TV programme in addition to the basic audio. When <b>Audio Description On</b> is selected, basic audio and Audio Description are provided only for those programmes that have Audio Description included.</td> </tr> <tr> <td data-bbox="554 919 691 950">Volume</td> <td data-bbox="691 919 1225 950">Changes the Audio Description volume</td> </tr> <tr> <td data-bbox="554 950 691 1010">Beep</td> <td data-bbox="691 950 1225 1010">Beeps when a programme with Audio Description information is selected</td> </tr> </tbody> </table>	Option		Hard of Hearing	This function is for the hearing impaired.	Audio Description	This function is for the blind, and provides explanatory audio describing the current situation in a TV programme in addition to the basic audio. When <b>Audio Description On</b> is selected, basic audio and Audio Description are provided only for those programmes that have Audio Description included.	Volume	Changes the Audio Description volume	Beep	Beeps when a programme with Audio Description information is selected
Option											
Hard of Hearing	This function is for the hearing impaired.										
Audio Description	This function is for the blind, and provides explanatory audio describing the current situation in a TV programme in addition to the basic audio. When <b>Audio Description On</b> is selected, basic audio and Audio Description are provided only for those programmes that have Audio Description included.										
	Volume	Changes the Audio Description volume									
	Beep	Beeps when a programme with Audio Description information is selected									
<b>ISM Method</b>	<p>A frozen or still picture displayed on the screen for prolonged periods will result in a ghost image remaining even when you change the image. Avoid allowing a fixed image to remain on the screen for prolonged periods.</p> <table border="1" style="width: 100%; border-collapse: collapse; margin-top: 10px;"> <thead> <tr> <th colspan="2" data-bbox="303 1103 1225 1134">Option</th> </tr> </thead> <tbody> <tr> <td data-bbox="303 1134 554 1164">Normal</td> <td data-bbox="554 1134 1225 1164">Sets it if image sticking is never a problem.</td> </tr> <tr> <td data-bbox="303 1164 554 1271">Orbiter</td> <td data-bbox="554 1164 1225 1271">Orbiter may help prevent ghost images. However, it is best not to allow any fixed image to remain on the screen. To avoid a permanent image on the screen, the screen will move every 2 minutes.</td> </tr> <tr> <td data-bbox="303 1271 554 1371">Colour Wash</td> <td data-bbox="554 1271 1225 1371">The colour block with the screen moved a little and the white pattern are alternately displayed. It is difficult to sense the afterimage occurred while the temporary afterimage is removed and the colour pattern is operating.</td> </tr> </tbody> </table>	Option		Normal	Sets it if image sticking is never a problem.	Orbiter	Orbiter may help prevent ghost images. However, it is best not to allow any fixed image to remain on the screen. To avoid a permanent image on the screen, the screen will move every 2 minutes.	Colour Wash	The colour block with the screen moved a little and the white pattern are alternately displayed. It is difficult to sense the afterimage occurred while the temporary afterimage is removed and the colour pattern is operating.		
Option											
Normal	Sets it if image sticking is never a problem.										
Orbiter	Orbiter may help prevent ghost images. However, it is best not to allow any fixed image to remain on the screen. To avoid a permanent image on the screen, the screen will move every 2 minutes.										
Colour Wash	The colour block with the screen moved a little and the white pattern are alternately displayed. It is difficult to sense the afterimage occurred while the temporary afterimage is removed and the colour pattern is operating.										
<b>Data Service</b> (only in Ireland.)	<p>This function allow users to choose between MHEG (Digital Teletext) and Teletext if both exist at the same time.</p>										
<b>Factory Reset</b>	<p>This function initializes all settings.</p> <div style="border: 1px solid black; padding: 10px; margin-top: 10px;"> <p> <b>NOTE</b></p> <ul style="list-style-type: none"> <li>In <b>Lock System "On"</b>, if you forget your password, press '0', '3', '2', '5' on the remote control handset.</li> </ul> </div>										
<b>Set ID</b>	<p>Adds an ID to the connected devices</p>										

Setting	Description	
<b>Mode Setting</b>	Default selection is " <b>Home Use</b> ". We recommend setting the TV to " <b>Home Use</b> " mode for the best picture in your home environment.	
	<b>Option</b>	
	Home Use	Selects it for the home environment.
	Store Demo	Selects it for the retail environment.
	Demo Mode	Sets to show special features of the TV. You can cancel the demo mode by pressing any buttons except the Volume and Mute buttons.
	<p><b>NOTE</b></p> <ul style="list-style-type: none"> <li>It is not possible to use <b>Demo Mode</b> in <b>Home Use</b> mode.</li> <li>In <b>Store Demo</b>, <b>Demo Mode</b> is automatically set to <b>On</b>.</li> <li>Once <b>Demo Mode</b> is set to <b>Off</b> in <b>Store Demo</b>, <b>Demo Mode</b> does not run and only the screen is reset.</li> <li>The screen is reset automatically after 5 minutes in <b>Demo Mode</b>.</li> </ul>	

## NETWORK Settings

(Depending on model)

- 1 Press **SETTINGS** to access the main menus.
- 2 Press the Navigation buttons to scroll to **NETWORK** and press **OK**.
- 3 Press the Navigation buttons to scroll to the setting or option you want and press **OK**.  
- To return to the previous level, press ↶.
- 4 When you are finished, press **EXIT**.

- Image shown may differ from your TV.

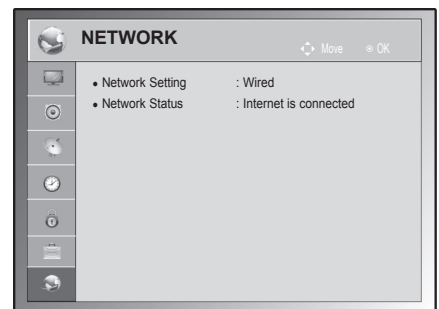

The available network settings are described in the following.

Setting	Description
<b>Network Setting</b>	Configure the network settings (See p.54).
<b>Network Status</b>	Display the network status (See p.55).

# MAKING CONNECTIONS

Connect various external devices to the TV and switch input modes to select an external device. For more information of external device's connection, refer to the manual provided with each device.

Available external devices are: HD receivers, DVD players, VCRs, audio systems, USB storage devices, PC, gaming devices, and other external devices.



## NOTE

- The external device connection may differ from the model.
- Connect external devices to the TV regardless of the order of the TV port.

## Connection overview

Connect various external devices to the ports on the TV back panel.

- 1 Find an external device you want to connect to your TV as shown on the following illustration.
- 2 Check the connection type of the external device.
- 3 Go to the appropriate illustration and check the connection details.

(Depending on model)

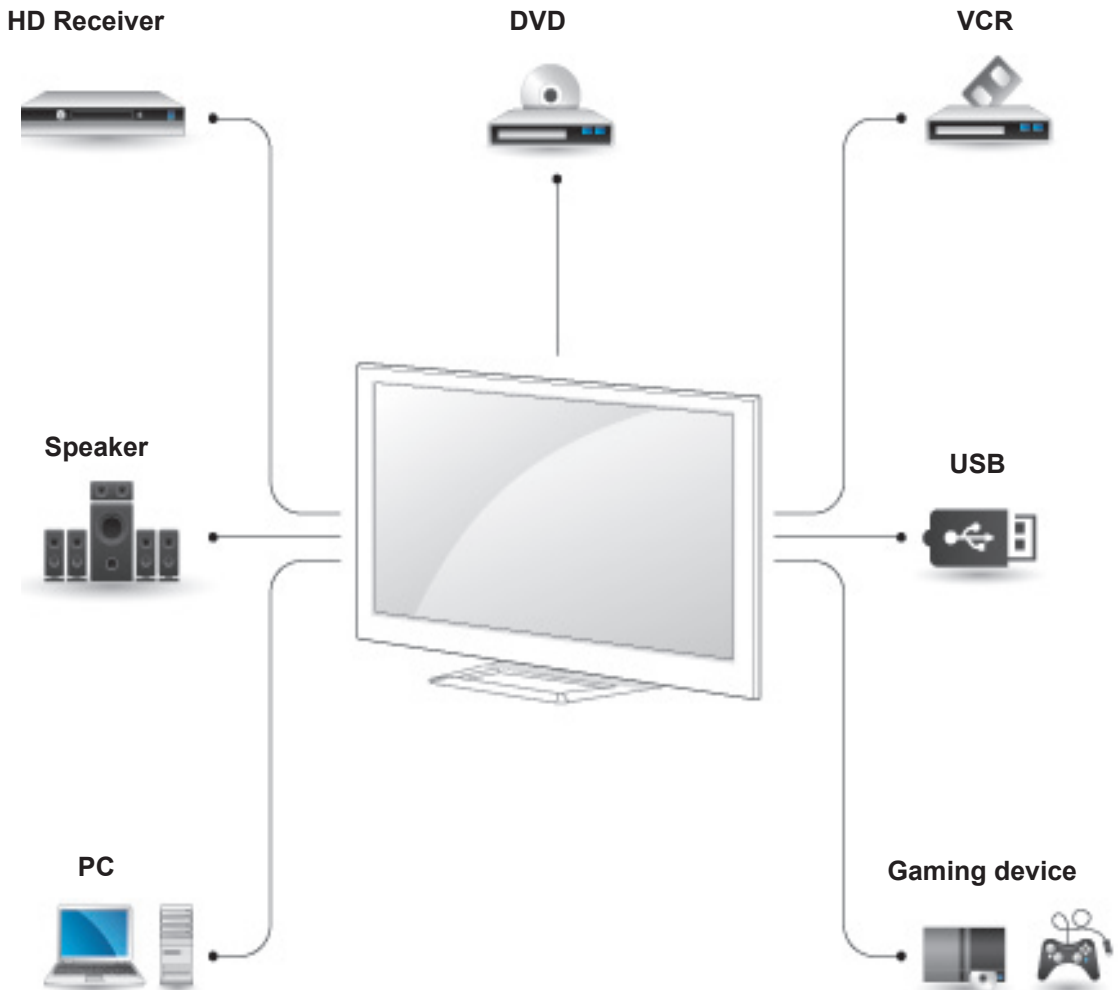

### NOTE

- If you connect a gaming device to the TV, use the cable supplied with the gaming device.
- Refer to the external equipment's manual for operating instructions.

- This part of MAKING CONNECTIONS mainly uses picture for 50/60PA65\*\*

## Connecting to a HD receiver, DVD, or VCR player

Connect a HD receiver, DVD, or VCR player to the TV and select an appropriate input mode.

### HDMI Connection

**HDMI is the best way to connect a device.**

Transmits the digital video and audio signals from an external device to the TV. Connect the external device and the TV with the HDMI cable as shown in the following illustration.



**NOTE**

- Use the latest High Speed HDMI™ Cable with CEC (Customer Electronics Control) function.
- High Speed HDMI™ Cables are tested to carry an HD signal up to 1080p and higher.

Choose any HDMI input port to connect.  
It does not matter which port you use.

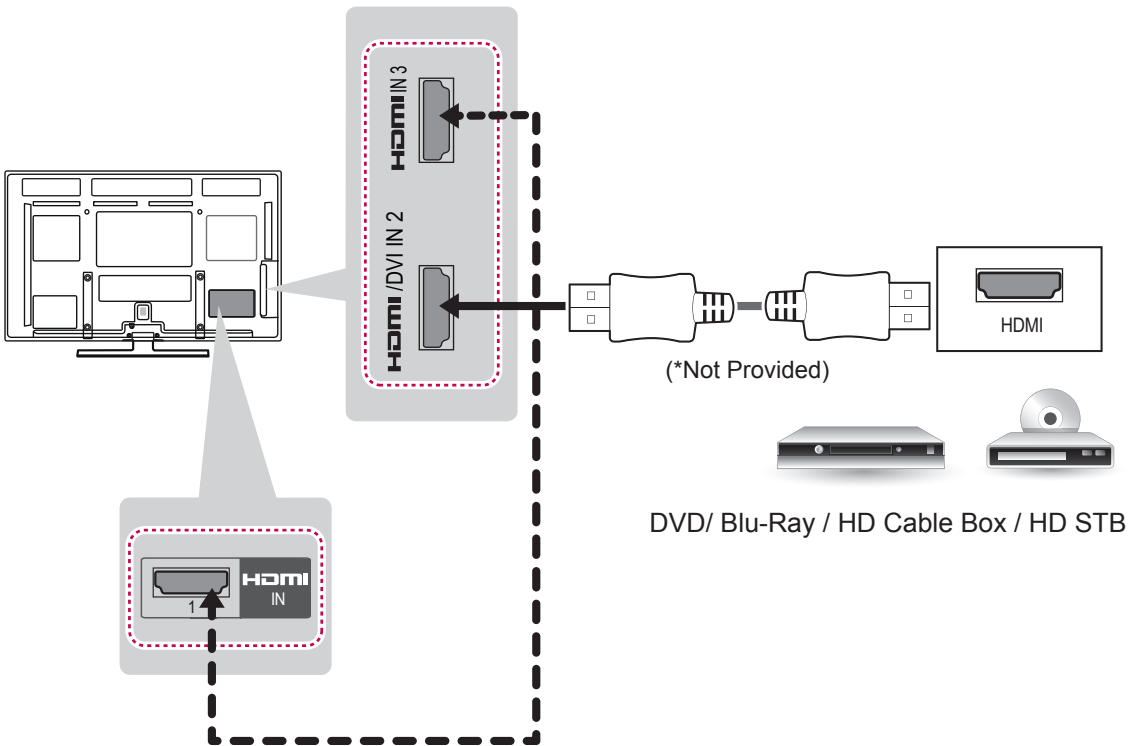

## DVI to HDMI Connection

Transmits the digital video signal from an external device to the TV. Connect the external device and the TV with the DVI-HDMI cable as shown in the following illustration. To transmit an audio signal, connect an audio cable.

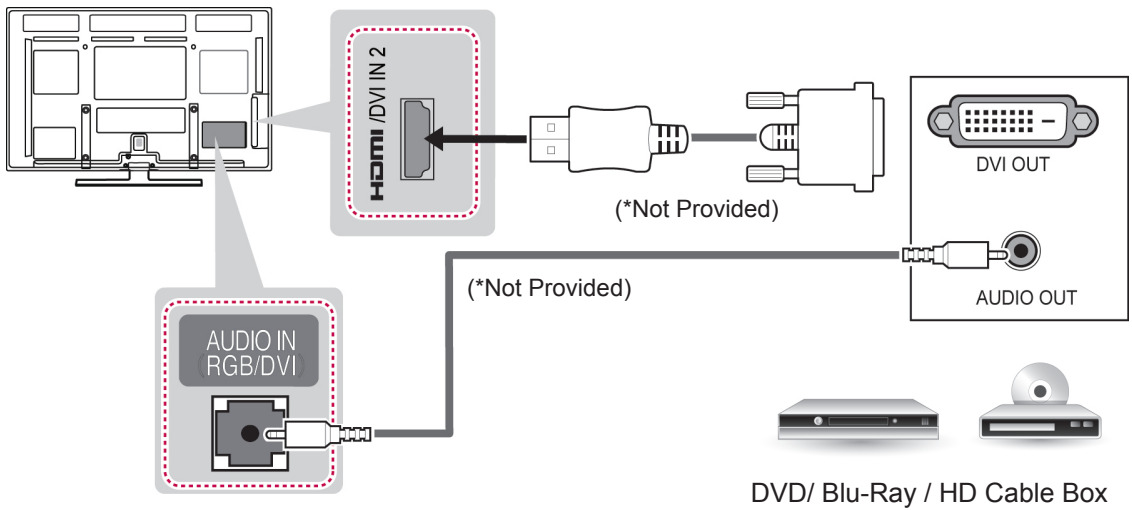

## Component Connection

Transmits the analog video and audio signals from an external device to the TV. Connect the external device and the TV with the component cable as shown in the following illustration.

**NOTE**

- If cables are installed incorrectly, it could cause the image to display in black and white or with distorted color.
- **Check to ensure the cable are matched with the corresponding color connection.**

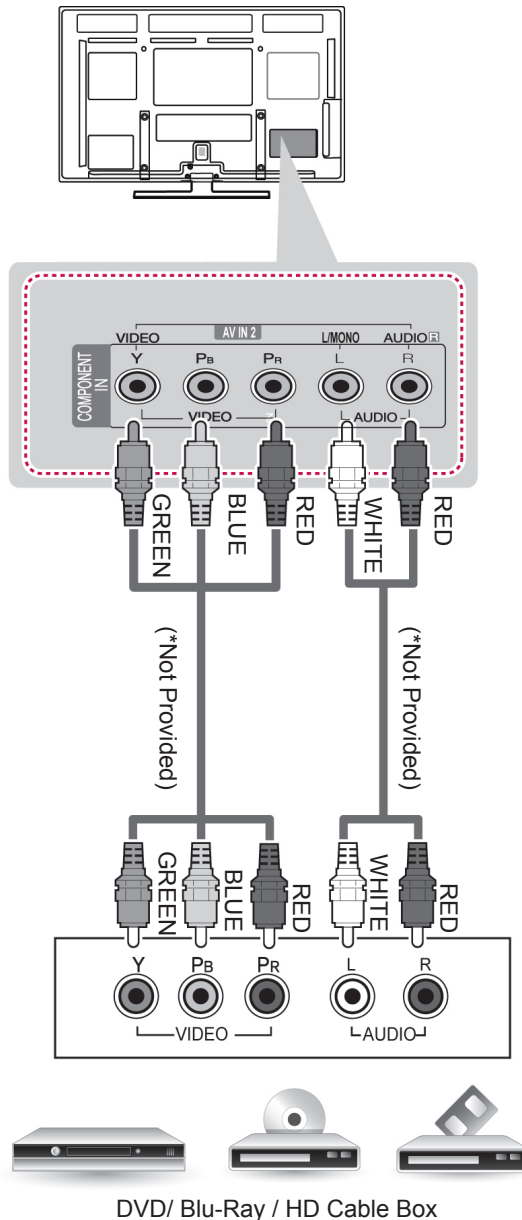

## Euro Scart connection

Transmits the video and audio signals from an external device to the TV set. Connect the external device and the TV set with the Euro Scart cable as shown on the following illustration. To display images by using progressive scan, make sure to use the Euro Scart cable.



**NOTE**

- Any Euro scart cable used must be signal shielded.

Current input model \ Output Type	AV1 (TV Out <sup>1</sup> )
Digital TV	O
Analogue TV, AV	Analogue TV
Component / RGB	Analogue TV
HDMI	Analogue TV

1 TV Out : Outputs Analogue TV or Digital TV signals.

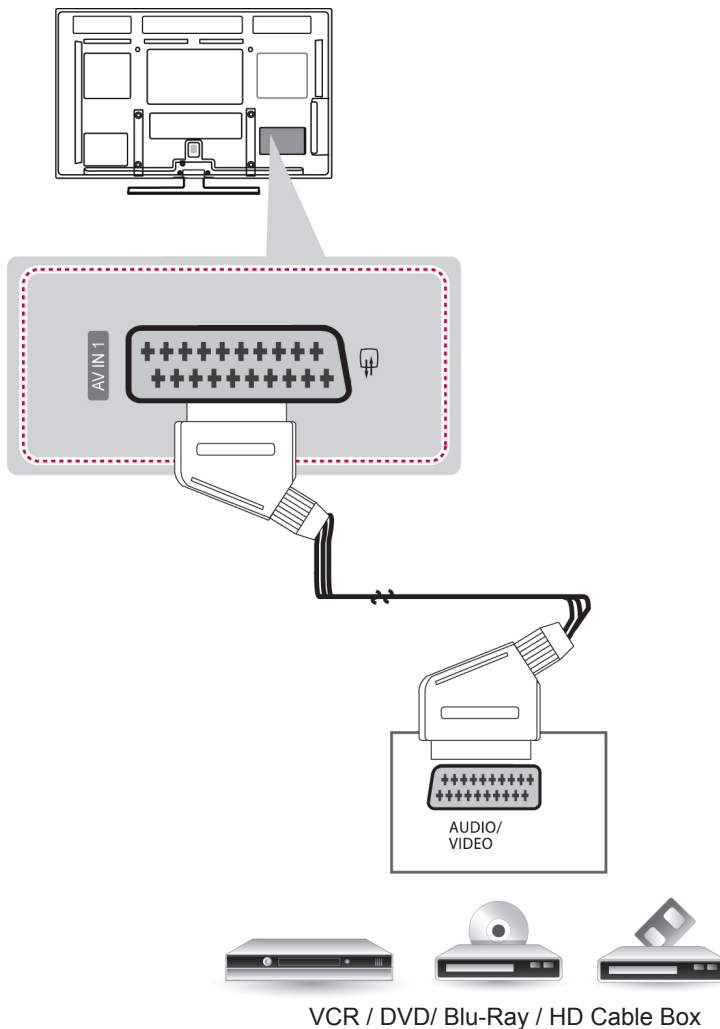

## Composite Connection

Transmits the analog video and audio signals from an external device to the TV. Connect the external device and the TV with the composite cable as shown in the following illustration.



### NOTE

- If you have a mono VCR, connect the audio cable from the VCR to the AUDIO L/MONO jack of the TV.

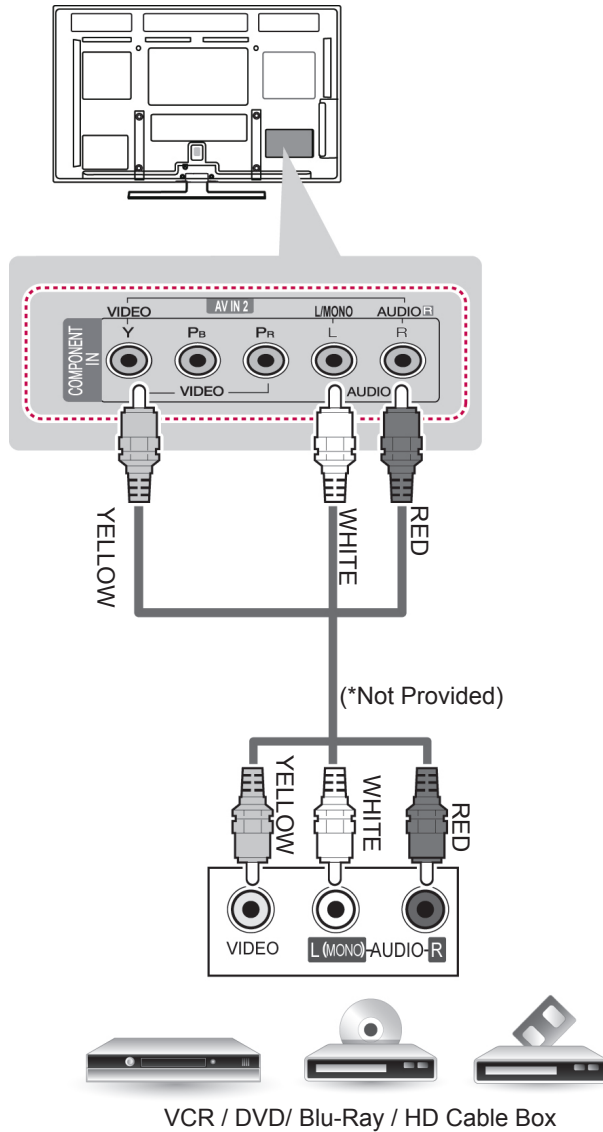

## Connecting to a PC

### NOTE

- Avoid keeping a fixed image on the set's screen for prolonged periods of time. The fixed image may become permanently imprinted on the screen; use a screen saver when possible.
- There may be interference relating to resolution, vertical pattern, contrast or brightness in PC mode. Change the PC mode to another resolution or change the refresh rate to another rate or adjust the brightness and contrast on the menu until the picture is clear. If the refresh rate of the PC graphic card can not be changed, change the PC graphic card or consult the manufacturer of the PC graphic card.
- The synchronization input waveform for Horizontal and Vertical frequencies are separate.
- We recommend using 1920x1080 for the PC mode, this should provide the best picture quality.
- Connect the signal cable from the monitor output port of the PC to the RGB (PC) port of the TV or the signal cable from the HDMI output port of the PC to the HDMI IN (or HDMI/DVI IN) port on the TV.
- Connect the audio cable from the PC to the Audio input on the TV. (Audio cables are not included with the TV).
- If using a sound card, adjust PC sound as required.
- If the graphic card on the PC does not output analogue and digital RGB simultaneously, connect only one of either RGB or HDMI IN (or HDMI/DVI IN) to display the PC output on the TV.
- DOS mode may not work depending on the video card if you use an HDMI to DVI cable.
- If you use too long an RGB-PC cable, there may be interference on the screen. We recommend using under 5m of cable. This provides the best picture quality.

## HDMI Connection, DVI to HDMI Connection or RGB Connection

Choose method A, B, or C to make connection.

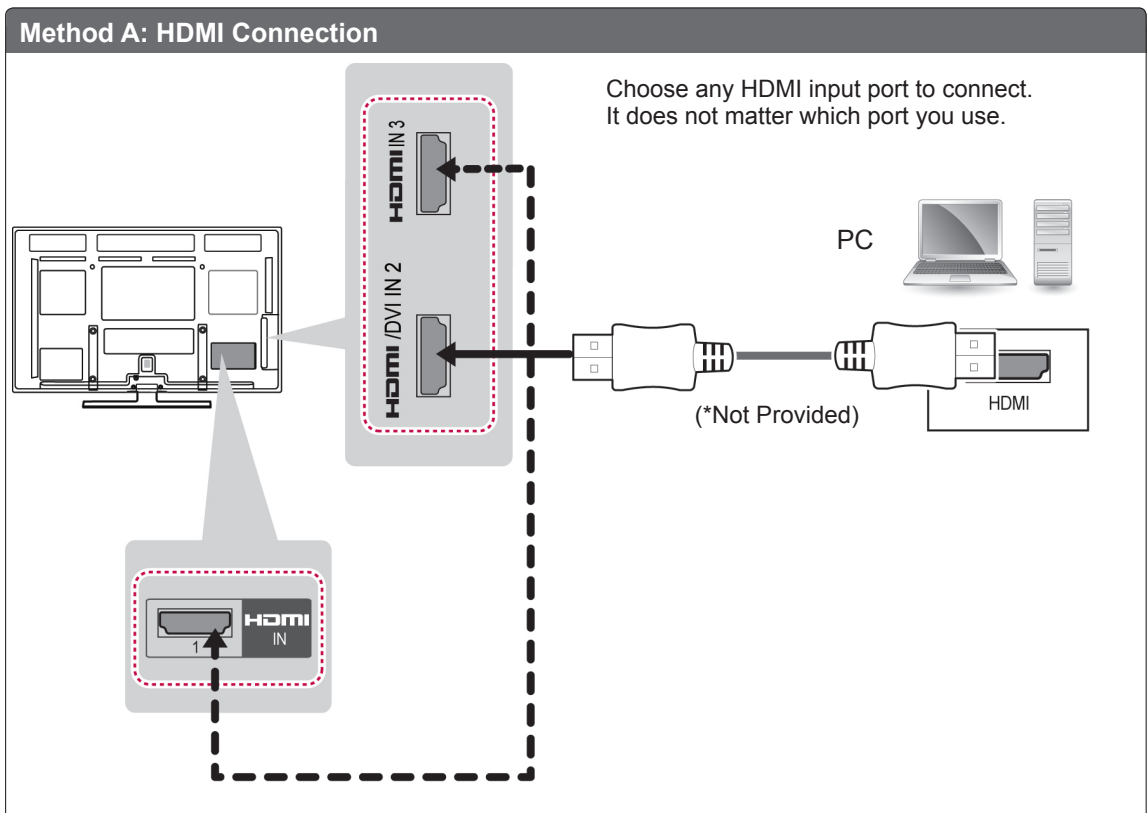

**Method B: DVI to HDMI Connection**

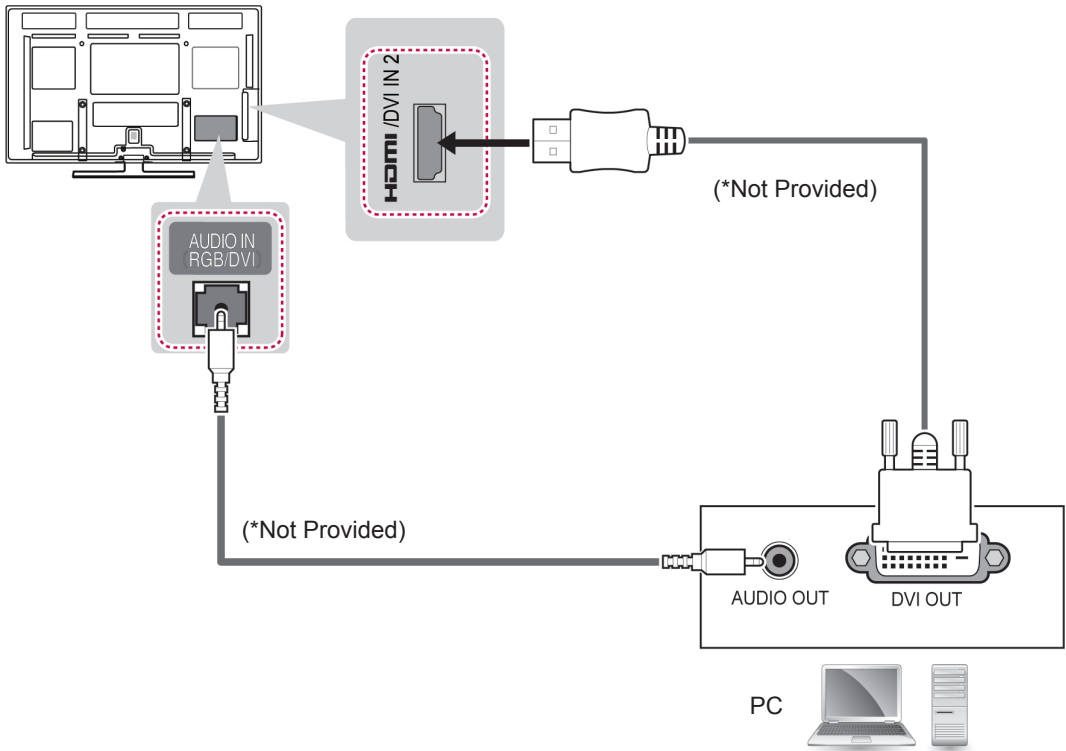

**Method C: RGB Connection**

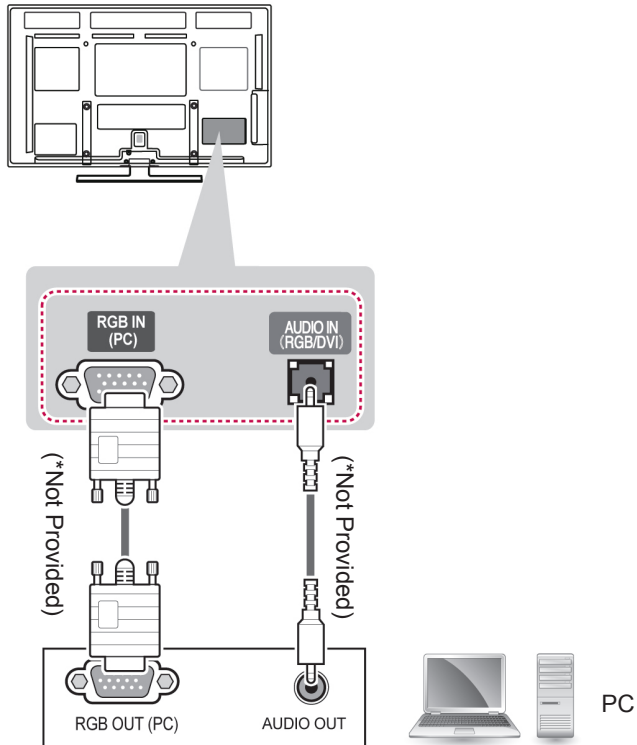

## Connecting to an Audio System

Use an optional external audio system instead of the built-in speaker.



### NOTE

- If you use an optional external audio device instead of the built-in speaker, set the TV speaker feature to off.

## Digital Optical Audio Connection

Transmits the digital audio signal from the TV to an external device. Connect the external device and the TV with the optical audio cable as shown in the following illustration.



### NOTE

- Do not look into the optical output port. Looking at the laser beam may damage your vision.
- Audio with ACP (Audio Copy Protection) function may block digital audio output.

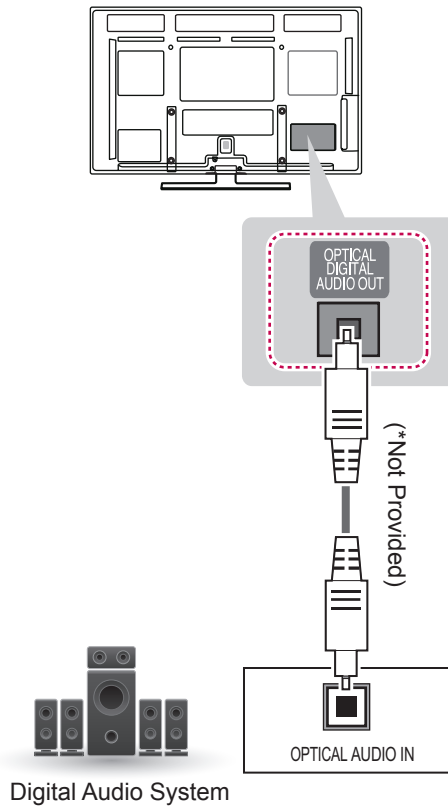

## Connecting to a USB

Connect a USB storage device such as a USB flash memory, external hard drive, or a USB memory card reader to the TV and access the Smart Share menu to use various multimedia files.

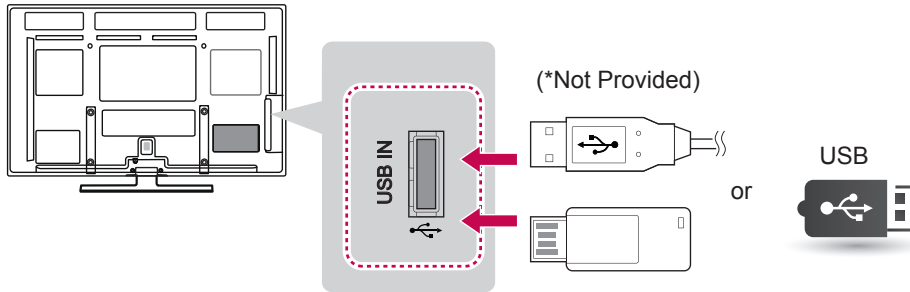

## Connecting to a CI Module

View the encrypted (pay) services in digital TV mode.

**!** NOTE

- Check if the CI module is inserted into the PCMCIA card slot in the right direction. If the module is not inserted properly, this can cause damage to the TV and the PCMCIA card slot.

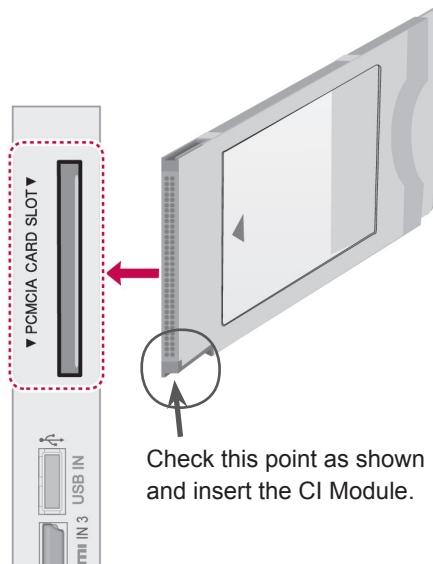

## SIMPLINK connection

Use the TV remote control to play and control the AV device connected with the HDMI cable through HDMI-CEC. Your TV only works with the devices that support HDMI-CEC.

Connect one end of the HDMI cable to the HDMI/DVI IN or HDMI IN terminal on the rear of the TV and the other end to the SIMPLINK device.

In wireless external output, SIMPLINK function is not supported.

### NOTE

- If the connected device does not support HDMI-CEC, the SIMPLINK feature is unavailable.
- To operate SIMPLINK, an High Speed HDMI Cable with \*CEC function should be used. (\*CEC: Consumer Electronics Control).

## Activating the SIMPLINK feature

- 1 Press INPUT to access the input sources.
- 2 Press Red button to access the SIMPLINK menus.
- 3 Press the Navigation buttons to scroll to **On**.
- 4 Press the Navigation buttons to scroll to one of the devices and press **OK**.
  - Image shown may differ from your TV.

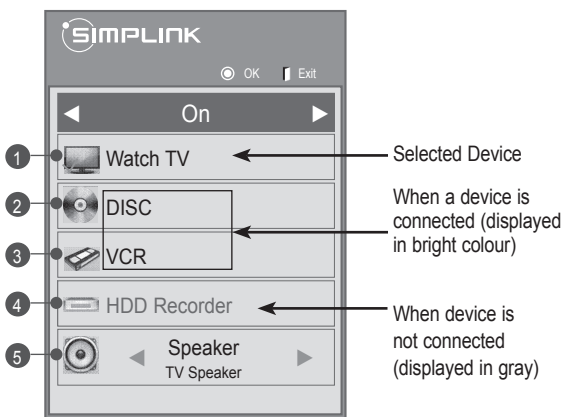

No.	Description
1	Displays the previously viewed TV channel.
2	Plays discs. When multiple discs are available, the title of the disc appears at the bottom of the screen.
3	Controls the connected VCR.
4	HDD recordings playback: Controls the recording stored in HDD.
5	Audio out to home theater speaker or Audio out to TV: Changes the audio output between Home theater speaker and TV speaker.

- A check mark appears in front of the selected device.
- Available devices display in a bright colour.
- Unavailable devices display in grey.

- 5 Control the selected AV device.
  - **Direct Play:** After connecting AV devices to the TV, you can directly control the devices and play media without additional settings.
  - **Select AV device:** Enables you to select one of the AV devices connected to the TV.
  - **Disc playback:** Control connected AV devices by pressing the Navigation buttons, **OK**, **▶**, **■**, **||**, **◀◀** and **▶▶** buttons.
  - **Power off all devices:** When you power off the TV, all connected devices are turned off.
  - **Switch audio-out:** Offers an easy way to switch audio-out.
  - **Sync Power on:** When the equipment with SIMPLINK function connected HDMI terminal starts to play, The TV will automatically turn on.

### NOTE

- If you change the input source by pressing INPUT, the progressing function of the SIMPLINK device will stop.
- If you select a device that has the home theater feature, the sound output automatically switches to the home theater speaker and the TV speaker turns off.
- If a connected SIMPLINK home theater system does not play the audio from the TV, connect the DIGITAL AUDIO OUT terminal on the rear of the TV to the DIGITAL AUDIO IN terminal on the back of the SIMPLINK device with an optical cable.

# TELETEXT

- This feature is not available in all countries. Teletext is a free service broadcast by most TV stations which gives up-to-the-minute information on news, weather, television programmes, share prices and many other topics.

The teletext decoder of this TV can support the SIMPLE, TOP and FASTEXT systems. SIMPLE (standard teletext) consists of a number of pages which are selected by directly entering the corresponding page number. TOP and FASTEXT are more modern methods allowing quick and easy selection of teletext information.

## Switch On/Off

Press the **TEXT** button to switch to teletext. The initial page or last page viewed appears on the screen.

Two page numbers, TV station name, date and time are displayed on the screen headline. The first page number indicates your selection, while the second shows the current page displayed. Press the **TEXT** button to switch off teletext. The previous mode reappears.

## Simple Text

### Page selection

- 1 Enter the desired page number as a three digit number with the NUMBER buttons. If during selection you press a wrong number, you must complete the three digit number and then re-enter the correct page number.
- 2 The **P**  $\wedge$  **V** (**P** + -) button can be used to select the preceding or following page.

## Top Text

The user guide displays four fields-red, green, yellow and blue at the bottom of the screen. The yellow field denotes the next group and the blue field indicates the next block.

### Block / Group / Page Selection

- 1 With the blue button you can progress from block to block.
- 2 Use the yellow button to proceed to the next group with automatic overflow to the next block.
- 3 With the green button you can proceed to the next existing page with automatic overflow to the next group..
- 4 Alternatively the **P**  $\wedge$  (**P** +) button can be used. The red button returns to the previous selection. Alternatively the **P**  $\vee$  (**P** -) button can be used.

### Direct Page Selection

As with SIMPLE teletext mode, you can select a page by entering it as a three digit number using the NUMBER buttons in TOP mode.

## Fastext

The teletext pages are colour coded along the bottom of the screen and are selected by pressing the corresponding coloured button.

### Page selection

- 1 Press the **T.OPT** button and then use Navigation buttons to select  menu. Display the index page.
- 2 You can select the pages which are colour coded along the bottom line with corresponding coloured buttons.
- 3 AS with SIMPLE teletext mode, you can select a page by entering its three digit page number with the NUMBER buttons in FASTEXT mode.
- 4 The **P ^ v** (P + -) button can be used to select the preceding or following page.

## Special Teletext Function

Press the **T. OPT** button and then use Navigation buttons to select the **Text Option** menu.

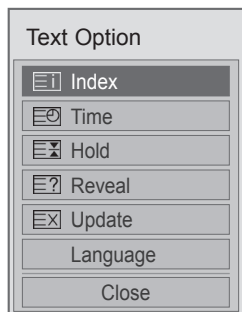

### Index

Select the each index page.

### Time

When viewing a TV programme, select this menu to display the time at the top right hand corner of the screen.

In the teletext mode, press this button to select a sub page number. The sub page number is displayed at the bottom of the screen. To hold or change the sub page, press the Red/Green, < > or NUMBER buttons.

### Hold

Stops the automatic page change which will occur if a teletext page consists of 2 or more sub pages.

The number of sub pages and the sub page displayed is, usually, shown on the screen below the time. When this menu is selected the stop symbol is displayed at the top left-hand corner of the screen and the automatic page change is inactive.

### Reveal

Select this menu to display concealed information, such as solutions to riddles or puzzles.

### Update

Displays the TV picture on the screen while waiting for a new teletext page. The display will appear at the top left hand corner of the screen. When the updated page is available then display will change to the page number. Select this menu again to view the updated teletext page.

### Language(depending on model)

In digital mode, Display the currently available language information and you can change the desired Teletext language.

### NOTE

- In UK(In digital mode), **T. OPT** button does not work.

# DIGITAL TELETEXT

- This function works in UK, Ireland only.

The TV gives you access to digital teletext which is greatly improved in various aspects such as text, graphics etc. This digital teletext can access special digital teletext services and specific services which broadcast digital teletext.

## Teletext within digital service



- 1 Press the numeric or **P**  $\wedge$  **V** (**P** + -) button to select a digital service which broadcasts digital teletext.
- 2 Follow the indications on digital teletext and move onto the next step by pressing **TEXT**, **OK**, **Navigation button**, **Red**, **Green**, **Yellow**, **Blue** or **NUMBER** buttons and etc.
- 3 To change digital teletext service, select a different service by the numeric or **P**  $\wedge$  **V** (**P** + -) button.

## Teletext in digital service

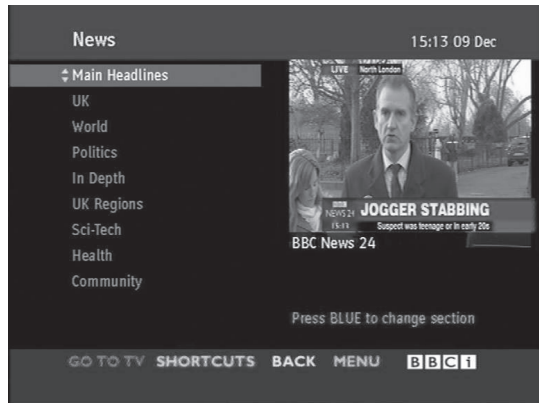

- 1 Press the numeric or **P**  $\wedge$  **V** (**P** + -) button to select a certain service which broadcasts digital teletext.
- 2 Press the **TEXT** or coloured button to switch on teletext.
- 3 Follow the indications on digital teletext and move onto the next step by pressing **OK**, **Navigation button**, **Red**, **Green**, **Yellow**, **Blue** or **NUMBER** buttons and so on.
- 4 Press the **TEXT** or colour button to switch off digital teletext and return to **TV** viewing.

Some services may allow you to access text services by pressing the Red button.

# MAINTENANCE

Update and clean your TV regularly to keep the best performance and to extend the product lifespan.

## Cleaning your TV



### CAUTION

- Make sure to turn the power off and disconnect the power cord and all other cables first.
- When the TV is left unattended and unused for a long time, disconnect the power cord from the wall outlet to prevent possible damage from lightning or power surges.

## Screen and frame

To remove dust or light dirt, wipe the surface with a dry, clean, and soft cloth.

To remove major dirt, wipe the surface with a soft cloth dampened in clean water or a diluted mild detergent. Then wipe immediately with a dry cloth.



### CAUTION

- Do not push, rub, or hit the surface with your fingernail or a sharp object, as this may result in scratches on the screen and image distortions.
- Do not use any chemicals, such as waxes, benzene, alcohol, thinners, insecticides, air fresheners, lubricants, as these may damage the screen's finish and cause discolourations.

## Cabinet and stand

To remove dust or light dirt, wipe the cabinet with a dry, clean, and soft cloth.

To remove major dirt, wipe the cabinet with a soft cloth dampened in a clean water or water containing a small amount of mild detergent. Then wipe immediately with a dry cloth.



### CAUTION

- Do not spray liquid onto the surface. If water enters the TV, it may result in fire, electric shock, or malfunction.
- Do not use any chemicals as this may deteriorate the surface.

## Power cord

Remove the accumulated dust or dirt on the power cord regularly.

## Preventing “Image burn” or “Burn-in” on your TV screen

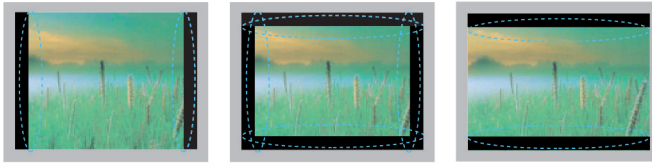

- If a fixed image displays on the TV screen for a long period of time, it will be imprinted and become a permanent disfigurement on the screen. This is “image burn” or “burn-in” and not covered by the warranty.
- If the aspect ratio of the TV is set to 4:3 for a long period of time, image burn may occur on the letterboxed area of the screen.
- Avoid displaying a fixed image on the TV screen for a long period of time (2 or more hours for LCD, 1 or more hours for the Plasma TV) to prevent image burn.

# TROUBLESHOOTING

## General

Problem	Solution
Cannot control the TV with the remote control.	<ul style="list-style-type: none"> <li>• Check the remote control sensor on the product and try again.</li> <li>• Check if there is any obstacle between the product and the remote control.</li> <li>• Check if the batteries are still working and properly installed (+ to +, - to -).</li> </ul>
No image display and no sound is produced.	<ul style="list-style-type: none"> <li>• Check if the product is turned on.</li> <li>• Check if the power cord is connected to a wall outlet.</li> <li>• Check if there is a problem in the wall outlet by connecting other products.</li> </ul>
Image appears slowly when the TV turns on.	<ul style="list-style-type: none"> <li>• The image is muted during the product startup process. This is normal. If the image does not appear in a few minutes, unplug the TV for 30 seconds and try again. If the image still does not appear, contact the authorized service center in your local area.</li> </ul>
Cannot connect external devices.	<ul style="list-style-type: none"> <li>• Refer to the “<b>Connection overview</b>” and connect an external device.</li> </ul>
The TV turns off suddenly.	<ul style="list-style-type: none"> <li>• Check the power control settings. The power supply may be interrupted.</li> <li>• Check if the Auto sleep feature is activated in the Time settings. Refer to the “<b>Sleep Timer</b>”.</li> <li>• If there is no signal while the TV is on, the TV will turn off automatically after 15 minutes of inactivity.</li> </ul>

## Audio

Problem	Solution
No sound is produced while images are displaying.	<ul style="list-style-type: none"> <li>• Press  + or - button.</li> <li>• Check if the sound is muted by pressing <b>MUTE</b>.</li> <li>• Scroll to other channels. There may be a problem with the broadcast.</li> <li>• Check if the audio cables are connected properly.</li> </ul>
One of the speakers produce noises or does not produce sound.	<ul style="list-style-type: none"> <li>• A change in ambient humidity or temperature may result in an unusual noise when the product turns on or off.</li> <li>• There is no problem with your product.</li> </ul>

## Video

Problem	Solution
An image displays in black and white or the colour quality is poor.	<ul style="list-style-type: none"> <li>Adjust the colour setting in the <b>PICTURE</b> menu.</li> <li>Keep a sufficient distance between this product and other electronic products.</li> <li>Scroll to other channels. There may a problem with the broadcast.</li> </ul>
Horizontal or vertical bars appears or images blur	<ul style="list-style-type: none"> <li>Check if there are local interferences such as an electrical appliance or power tool.</li> </ul>
Lines or streaks appear on images	<ul style="list-style-type: none"> <li>Check the antenna or aim the antenna to the proper direction.</li> </ul>
Afterimages (ghosts) appear when the product turns off	<ul style="list-style-type: none"> <li>Pixels may have been damaged from a fixed image displayed for a long time (image burn). Use a screen saver to prevent the pixel damage on the screen.</li> </ul>
The power is on but the screen appears extremely dark.	<ul style="list-style-type: none"> <li>Adjust the brightness and contrast in the <b>PICTURE</b> menu.</li> </ul>
"No Signal" appears on the screen.	<ul style="list-style-type: none"> <li>Check if the signal cable is connected between the TV and products properly.</li> <li>Check the selected input source by pressing <b>INPUT</b>.</li> </ul>
The display offset is wrong.	<ul style="list-style-type: none"> <li>Adjust the position setting in the <b>PICTURE</b> menu.</li> <li>Check if the video card resolution and frequency are supported by the product. If the frequency is out of range, set to the recommended resolution using the display settings on the external device.</li> </ul>
Thin lines appear in the background of the screen.	<ul style="list-style-type: none"> <li>Check the video cable connections.</li> </ul>
Horizontal noises appear or characters blur.	<ul style="list-style-type: none"> <li>Adjust the Phase setting in the <b>PICTURE</b> menu. Refer to the "<b>SCREEN</b>".</li> </ul>
The reception on some channels is poor	<ul style="list-style-type: none"> <li>Scroll to other channels. There may a problem with the broadcast.</li> <li>The station signal may be weak. Aim the antenna to the proper direction.</li> <li>Check if there is local interference such as an electrical appliance or power tool.</li> </ul>

## Pentouch

Problem	Solution
The touch pen does not work.	<ul style="list-style-type: none"> <li>Check that you used the remote control to enter Pentouch mode.</li> <li>Check that the Pentouch dongle is connected to the computer and the red LED is on.</li> <li>Press the  button on the touch pen to check that it is powered on.</li> <li>Check that the touch pen is paired for use. (The touch pen is correctly paired if the red LED is on once when you press the Touch Home button on the touch pen.)</li> <li>Set the computer screen to display only on the TV.</li> </ul>
The TV screen doesn't look normal when using Pentouch.	<ul style="list-style-type: none"> <li>A Check that the computer is correctly connected to the TV.</li> <li>A Check that you are using the optimal resolution.</li> <li>Set the aspect ratio on the TV to Just Scan.</li> </ul>
The touch pen is touched on wrong positions.	<ul style="list-style-type: none"> <li>Set the computer screen to display only on the TV.</li> <li>If the point you touch on the TV screen using the touch pen and the point indicated as touched on the computer screen do not match when the computer and the TV are connected by a PC signal (RGB) cable, use the TV remote control to select [Home] → [PICTURE] → [SCREEN] (RGB) , then select [Auto Configure] to adjust the screen.</li> </ul>
The touch pen movement is not smooth.	<ul style="list-style-type: none"> <li>Check whether the computer and the TV are too far from each other. Check whether there are too many obstructions between the computer and the TV.</li> <li>A Check whether many other applications are running on the computer. (Please avoid running other applications while using the Pentouch program.)</li> </ul>

# SPECIFICATIONS

MODELS		42PA45**	42PA49**
Dimensions (W x H x D)	With stand	983.6 mm x 655.0 mm x 246.7 mm	983.6 mm x 655.0 mm x 246.7 mm
	Without stand	983.6 mm x 601.3 mm x 58.0 mm	983.6 mm x 601.3 mm x 58.0 mm
Weight	With stand	20.6 kg	20.6 kg
	Without stand	19.0 kg	19.0 kg
MODELS		50PA45**	50PA49**
Dimensions (W x H x D)	With stand	1168.0 mm x 758.0 mm x 297.0 mm	1168.0 mm x 758.0 mm x 297.0 mm
	Without stand	1168.0 mm x 704.0 mm x 53.0 mm	1168.0 mm x 704.0 mm x 53.0 mm
Weight	With stand	28.2 kg	28.2 kg
	Without stand	25.8 kg	25.8 kg
MODELS		50PA55**	50PA65**
Dimensions (W x H x D)	With stand	1168.0 mm x 758.0 mm x 297.0 mm	1168.0 mm x 758.0 mm x 297.0 mm
	Without stand	1168.0 mm x 704.0 mm x 53.0 mm	1168.0 mm x 704.0 mm x 53.0 mm
Weight	With stand	28.8 kg	28.8 kg
	Without stand	26.4 kg	26.4 kg
MODELS		60PA55**	60PA65**
Dimensions (W x H x D)	With stand	1386.8 mm x 883.2 mm x 354.7mm	1386.8 mm x 883.2 mm x 354.7mm
	Without stand	1386.8 mm x 818.2 mm x 53.0 mm	1386.8 mm x 818.2 mm x 53.0 mm
Weight	With stand	40.6 kg	40.6 kg
	Without stand	36.4 kg	36.4 kg
CI Module Size (Width x Height x Depth)		100.0 mm x 55.0 mm x 5.0 mm	

Product specifications shown above may be changed without prior notice due to upgrade of product functions. For the power supply and power consumption, refer to the label attached to the product.

Environment condition	Operating Temperature		0 °C to 40 °C
	Operating Humidity		Less than 80 %
	Storage Temperature		-20 °C to 60 °C
	Storage Humidity		Less than 85 %
Television System	Digital TV <sup>1</sup>	Digital TV	Analogue TV
	DVB-T/T2 DVB-C	DVB-T DVB-C	PAL/SECAM B/G/D/K, PAL I/II, SECAM L/L <sup>2</sup>
Programme Coverage	VHF, UHF		VHF: E2 to E12, UHF: E21 to E69, CATV: S1 to S20, HYPER: S21 to S47
Maximum number of storable programmes	1,800		
External Antenna Impedance	75 Ω		75 Ω

1 Only DVB-T2 support models

2 Except for DVB-T2 support models

#### RGB-PC, HDMI/DVI-PC supported mode

Resolution	Horizontal Frequency (kHz)	Vertical Frequency (Hz)
640x350	31.468	70.09
720x400	31.469	70.08
640x480	31.469	59.94
800x600	37.879	60.31
1024x768	48.363	60.00
1360x768	47.712	60.01
1280x1024 (HDMI-PC)	63.981	60.02
1920x1080	67.5	60.00

(Except for 42/50PA45\*\*)

#### Component port connecting information

Component ports on the TV	Y	P <sub>B</sub>	P <sub>R</sub>
---------------------------	---	----------------	----------------

Video output ports on DVD player	Y	P <sub>B</sub>	P <sub>R</sub>
	Y	B-Y	R-Y
	Y	Cb	Cr
	Y	Pb	Pr

Signal	Component
480i/576i	O
480p/576p	O
720p/1080i	O
1080p	O (50 Hz / 60 Hz only)

#### HDMI/DVI-DTV supported mode













Resolution	Horizontal Frequency (kHz)	Vertical Frequency (Hz)
720x480	31.469	59.94
	31.5	60
720x576	31.25	50
	37.5	50
1280x720	44.96	59.94
	45	60
	45	60
1920x1080	33.72	59.94
	33.75	60
	28.125	50
	26.97	23.97
	27	24
	33.716	29.976
	33.75	30.00
	56.25	50
	67.43	59.94
	67.5	60

## Video supported mode

File Extension name	Video Decoder	Audio Codec	Max Resolution
mpg, mpeg	MPEG1, MPEG2	MP2,MP3,Dolby Digital,LPCM	1920x1080@30p (only , Motion JPEG 640x480@30p)
dat	MPEG1	MP2	
ts,trp,tp	MPEG2, H.264, VC1	MP2,MP3,Dolby Digital	
vob	MPEG1, 2	MP2,MP3,Dolby Digital,LPCM	
mp4, mov	MPEG4,DivX 3.11, DivX 4.12, DivX 5.x, DivX 6, Xvid 1.00, Xvid 1.01, Xvid 1.02, Xvid 1.03, Xvid 1.10-beta1/2, H.264	MP3	
mkv	H.264, MPEG-1,2,4	MP2,MP3,Dolby Digital, LPCM	
divx, avi	MPEG2, MPEG4,DivX 3.11, DivX 4.DivX 5, DivX 6, Xvid 1.00, Xvid 1.01, Xvid 1.02, Xvid 1.03, Xvid 1.10-beta1/2, H.264	MP2,MP3,Dolby Digital,LPCM, ADPCM	
Motion JPEG (avi, mp4, mkv)	JPEG	LPCM, ADPCM	
asf, wmv	VC1	WMA	
flv	Sorenson H.263, H264	MP3	

# IR CODES

- (This feature is not available for all models.)

Code (Hexa)	Function	Note
08	 (POWER)	Remote control Button (Power On/Off)
95	ENERGY SAVING	Remote control Button
0B	INPUT	Remote control Button
F0	TV/RAD	Remote control Button
10-19	Number Key 0-9	Remote control Button
53	LIST	Remote control Button
1A	Q.VIEW	Remote control Button
02	 +	Remote control Button
03	 -	Remote control Button
1E	FAV	Remote control Button
09	MUTE	Remote control Button
00	<b>P</b>  (P +)	Remote control Button
01	<b>P</b>  (P -)	Remote control Button
43	SETTINGS	Remote control Button
AB	GUIDE	Remote control Button
45	Q.MENU	Remote control Button
28		Remote control Button
AA	INFO	Remote control Button
5B	EXIT	Remote control Button
44	OK	Remote control Button
40		Remote control Button
41		Remote control Button
07	<	Remote control Button
06	>	Remote control Button
72	RED	Remote control Button
71	GREEN	Remote control Button
63	YELLOW	Remote control Button
61	BLUE	Remote control Button
20	TEXT	Remote control Button
21	T.OPT(T.Option)	Remote control Button
39	SUBTITLE	Remote control Button
B1		Remote control Button
B0		Remote control Button
BA		Remote control Button
8E		Remote control Button
8F		Remote control Button
79	RATIO	Remote control Button
91	AD	Remote control Button
30	AV MODE	Remote control Button
7E	SIMPLINK	Remote control Button

# EXTERNAL CONTROL DEVICE SETUP

## RS-232C Setup

Connect the RS-232C (serial port) input jack to an external control device (such as a computer or an A/V control system) to control the product's functions externally.

Connect the serial port of the control device to the RS-232C jack on the product back panel.

Note: RS-232C connection cables are not supplied with the product.

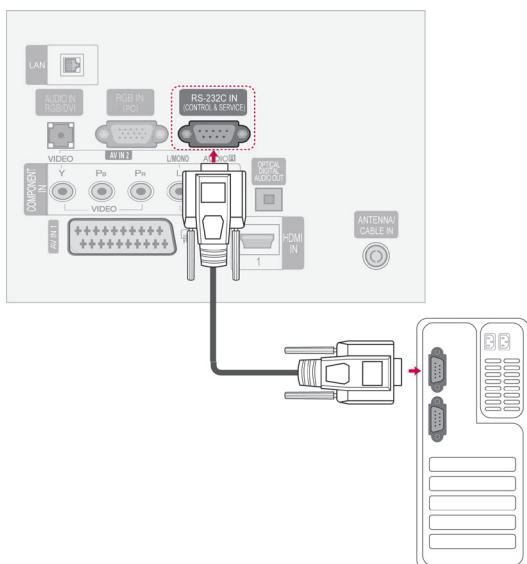

ENGLISH

## Type of connector; D-Sub 9-Pin Male

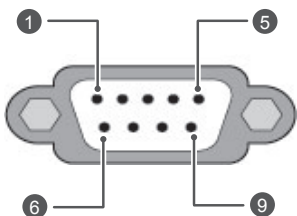

No.	Pin name
1	No connection
2	RXD (Receive data)
3	TXD (Transmit data)
4	DTR (DTE side ready)
5	GND
6	DSR (DCE side ready)
7	RTS (Ready to send)
8	CTS (Clear to send)
9	No Connection

## RS-232C Configurations

### 7-Wire Configurations (Standard RS-232C cable)

	PC	TV	
RXD	2	3	TXD
TXD	3	2	RXD
GND	5	5	GND
DTR	4	6	DSR
DSR	6	4	DTR
RTS	7	8	CTS
CTS	8	7	RTS

D-Sub 9                      D-Sub 9

### 3-Wire Configurations(Not standard)

	PC	TV	
RXD	2	3	TXD
TXD	3	2	RXD
GND	5	5	GND
DTR	4	6	DTR
DSR	6	4	DSR
RTS	7	7	RTS
CTS	8	8	CTS

D-Sub 9                      D-Sub 9

### Set ID

Set ID number. "Real Data Mapping" on See p.110

- 1 Press **SETTINGS** to access the main menus.
- 2 Press the Navigation buttons to scroll to **OPTION** and press **OK**.
- 3 Press the Navigation buttons to scroll to **SET ID** and press **OK**.
- 4 Scroll left or right to select a set ID number and select **Close**. The adjustment range is 1-99.
- 5 When you are finished, press **EXIT**.

## Communication Parameters

- Baud rate: 9600 bps (UART)
- Data length: 8 bits
- Parity : None
- Stop bit: 1 bit
- Communication code: ASCII code
- Use a crossed (reverse) cable.

## Command reference list

	COMMAND1	COMMAND2	DATA (Hexadecimal)		COMMAND1	COMMAND2	DATA (Hexadecimal)
01. Power	k	a	00 to 01	13. Treble	k	r	00 to 64
02. Aspect Ratio	k	c	(See p.107)	14. Bass	k	s	00 to 64
03. Screen Mute	k	d	(See p.107)	15. Balance	k	t	00 to 64
04. Volume Mute	k	e	00 to 01	16. Colour Temperature	x	u	00 to 64
05. Volume Control	k	f	00 to 64	17. ISM Method	j	p	(See p.109)
06. Contrast	k	g	00 to 64	18. Energy Saving	j	q	00 to 05
07. Brightness	k	h	00 to 64	19. Auto Configuration	j	u	01
08. Colour	k	i	00 to 64	20. Tune Command	m	a	(See p.109)
09. Tint	k	j	00 to 64	21. Programme Add/Skip	m	b	00 to 01
10. Sharpness	k	k	00 to 32	22. Key	m	c	Key Code
11. OSD Select	k	l	00 to 01	23. Input select (Main)	x	b	(See p.110)
12. Remote Control Lock Mode	k	m	00 to 01				

- \* Note : During USB operations such as DivX or EMF, all commands except Power(ka) and Key(mc) are not executed and treated as NG.

## Transmission / Receiving Protocol

### Transmission

**[Command1][Command2][ ][Set ID][ ][Data][Cr]**

- [Command 1] : First command to control the TV.(j, k, m or x)
- [Command 2] : Second command to control the TV.
- [Set ID] : You can adjust the set ID to choose desired monitor ID number in option menu.  
Adjustment range is 1 to 99. When selecting Set ID '0', every connected set is controlled.  
Set ID is indicated as decimal (1 to 99) on menu and as Hexa decimal (0x0 to 0x63) on transmission/receiving protocol.
- [DATA] : To transmit command data. Transmit 'FF' data to read status of command.
- [Cr] : Carriage Return  
ASCII code '0x0D'
- [ ] : ASCII code 'space (0x20)'

### OK Acknowledgement

**[Command2][ ][Set ID][ ][OK][Data][x]**

- \* The set transmits ACK (acknowledgement) based on this format when receiving normal data. At this time, if the data is data read mode, it indicates present status data. If the data is data write mode, it returns the data of the PC computer.

### Error Acknowledgement

**[Command2][ ][Set ID][ ][NG][Data][x]**

- \* The set transmits ACK (acknowledgement) based on this format when receiving abnormal data from non-viable functions or communication errors.

**Data 00: Illegal Code**

**01. Power (Command: k a)**

- ▶ To control Power On/Off of the set.

```
Transmission[k][a][ ][Set ID][ ][Data][Cr]
```

Data 00 : Power Off            01 : Power On

```
Ack [a][ ][Set ID][ ][OK/NG][Data][x]
```

- ▶ To show Power On/Off.

```
Transmission [k][a][ ][Set ID][ ][FF][Cr]
```

```
Ack [a][ ][Set ID][ ][OK/NG][Data][x]
```

- \* Similarly, if other functions transmit '0xFF' data based on this format, Acknowledgement data feed back presents status about each function.
- \* OK Ack., Error Ack. and other message may display on the screen when TV is power On.

**02. Aspect Ratio (Command: k c) (Main Picture Size)**

- ▶ To adjust the screen format. (Main picture format)  
You can also adjust the screen format using the Aspect Ratio in the Q.MENU. or **PICTURE** menu.

```
Transmission [k][c][ ][Set ID][ ][Data][Cr]
```

Data 01 : Normal screen        07 : 14:9  
          (4:3)                    09 : Just Scan  
02 : Wide screen (16:9)      0B : Full Wide  
06 : Original                 10 to 1F : Cinema Zoom 1 to 16

```
Ack [c][ ][Set ID][ ][OK/NG][Data][x]
```

- \* Using the PC input, you select either 16:9 or 4:3 screen aspect ratio.
- \* In DTV/HDMI (1080i 50 Hz / 60 Hz, 720p 50Hz / 60 Hz, 1080p 24 Hz / 30 Hz / 50 Hz / 60 Hz), Component( 720p, 1080i, 1080p 50 Hz / 60 Hz) mode, Just Scan is available.
- \* Full Wide is supported only for Digital, Analogue, AV.

**03. Screen Mute (Command: k d)**

- ▶ To select screen mute on/off.

```
Transmission [k][d][ ][Set ID][ ][Data][Cr]
```

Data 00 : Screen mute off (Picture on)  
          Video mute off  
01 : Screen mute on (Picture off)  
10 : Video mute on

```
Ack [d][ ][Set ID][ ][OK/NG][Data][x]
```

- \* In case of video mute on only, TV will display On Screen Display(OSD). But, in case of Screen mute on, TV will not display OSD.

**04. Volume Mute (Command: k e)**

- ▶ To control volume mute on/off.  
You can also adjust mute using the MUTE button on remote control.

```
Transmission [k][e][ ][Set ID][ ][Data][Cr]
```

Data 00 : Volume mute on (Volume off)  
01 : Volume mute off (Volume on)

```
Ack [e][ ][Set ID][ ][OK/NG][Data][x]
```

**05. Volume Control (Command: k f)**

- ▶ To adjust volume.  
You can also adjust volume with the VOLUME buttons on remote control.

```
Transmission [k][f][ ][Set ID][ ][Data][Cr]
```

Data Min : 00 to Max : 64  
\* Refer to 'Real data mapping'. See p.110.

```
Ack [f][ ][Set ID][ ][OK/NG][Data][x]
```

**06. Contrast (Command: k g)**

- ▶ To adjust screen contrast.  
You can also adjust contrast in the **PICTURE** menu.

```
Transmission [k][g][ ][Set ID][ ][Data][Cr]
```

Data Min : 00 to Max : 64  
\* Refer to 'Real data mapping'. See p.110.

```
Ack [g][ ][Set ID][ ][OK/NG][Data][x]
```

**07. Brightness (Command: k h)**

- ▶ To adjust screen brightness.  
You can also adjust brightness in the **PICTURE** menu.

```
Transmission [k][h][ ][Set ID][ ][Data][Cr]
```

Data Min : 00 to Max : 64  
\* Refer to 'Real data mapping'. See p.110.

```
Ack [h][ ][Set ID][ ][OK/NG][Data][x]
```

**08. Colour (Command: k i)**

- ▶ To adjust the screen colour.  
You can also adjust colour in the **PICTURE** menu.

```
Transmission [k][i][ ][Set ID][ ][Data][Cr]
```

Data Min : 00 to Max : 64  
\* Refer to 'Real data mapping'. See p.110.

```
Ack [i][ ][Set ID][ ][OK/NG][Data][x]
```

**09. Tint (Command: k j)**

- ▶ To adjust the screen tint.  
You can also adjust tint in the **PICTURE** menu.

`Transmission [k][j][ ][Set ID][ ][Data][Cr]`

Data Red : 00 to Green : 64

\* Refer to 'Real data mapping'. See p.110.

`Ack [j][ ][Set ID][ ][OK/NG][Data][x]`

**10. Sharpness (Command: k k)**

- ▶ To adjust the screen sharpness.  
You can also adjust sharpness in the **PICTURE** menu.

`Transmission [k][k][ ][Set ID][ ][Data][Cr]`

Data Min : 00 to Max : 32

\* Refer to 'Real data mapping'. See p.110.

`Ack [k][ ][Set ID][ ][OK/NG][Data][x]`

**11. OSD Select (Command: k l)**

- ▶ To select OSD (On Screen Display) on/off when controlling remotely.

`Transmission [k][l][ ][Set ID][ ][Data][Cr]`

Data 00 : OSD off                      01 : OSD on

`Ack [l][ ][Set ID][ ][OK/NG][Data][x]`

**12. Remote control lock mode (Command: k m)**

- ▶ To lock the front panel controls on the monitor and remote control.

`Transmission [k][m][ ][Set ID][ ][Data][Cr]`

Data 00 : Lock off                      01 : Lock on

`Ack [m][ ][Set ID][ ][OK/NG][Data][x]`

\* If you are not using the remote control, use this mode.  
When main power is on/off, external control lock is released.

\* In the standby mode, if key lock is on, TV will not turn on by power on key of IR & Local Key.

**13. Treble (Command: k r)**

- ▶ To adjust treble.  
You can also adjust treble in the **AUDIO** menu.

`Transmission [k][r][ ][Set ID][ ][Data][Cr]`

Data Min : 00 to Max : 64

\* Refer to 'Real data mapping'. See p.110.

`Ack [r][ ][Set ID][ ][OK/NG][Data][x]`

**14. Bass (Command: k s)**

- ▶ To adjust bass.  
You can also adjust bass in the **AUDIO** menu.

`Transmission [k][s][ ][Set ID][ ][Data][Cr]`

Data Min : 00 to Max : 64

\* Refer to 'Real data mapping'. See p.110..

`Ack [s][ ][Set ID][ ][OK/NG][Data][x]`

**15. Balance (Command: k t)**

- ▶ To adjust balance.  
You can also adjust balance in the **AUDIO** menu.

`Transmission [k][t][ ][Set ID][ ][Data][Cr]`

Data Min : 00 to Max : 64

\* Refer to 'Real data mapping'. See p.110.

`Ack [t][ ][Set ID][ ][OK/NG][Data][x]`

**16. Colour Temperature (Command: x u)**

- ▶ To adjust colour temperature. You can also adjust Colour Temperature in the **PICTURE** menu.

`Transmission [x][u][ ][Set ID][ ][Data][Cr]`

Data Min : 00 to Max : 64

\* Refer to 'Real data mapping'. See p.110.

`Ack [u][ ][Set ID][ ][OK/NG][Data][x]`

**17. ISM Method (Command: j p)**

- ▶ To control the ISM method. You can also adjust ISM Method in **OPTION** menu.

```
Transmission [j][p][ ][Set ID][ ][Data][Cr]
```

Data 02: Orbiter  
08: Normal  
20: Colour Wash

```
Ack [p][ ][Set ID][ ][OK/NG][Data][x]
```

**18. Energy Saving (Command: j q)**

- ▶ To reduce the power consumption of the TV. You can also adjust Energy Saving in **PICTURE** menu.

```
Transmission [j][q][ ][Set ID][ ][Data][Cr]
```

Data 00: Off  
01: Minimum  
02: Medium  
03: Maximum  
04: Intelligent Sensor  
05: Screen Off

```
Ack [q][ ][Set ID][ ][OK/NG][Data][x]
```

**19. Auto Configure(Command: j u)**

- ▶ To adjust picture position and minimize image shaking automatically. It works only in RGB (PC) mode.

```
Transmission [j][u][ ][Set ID][ ][Data][Cr]
```

Data 01: To set

```
Ack [u][ ][Set ID][ ][OK/NG][Data][x]
```

**20. Tune Command (Command: m a)**

- ▶ Select channel to following physical number.

```
Transmission [m][a][ ][Set ID][ ][Data0][ ][Data1][ ][Data2][Cr]
```

Data00 : High channel data  
Data01 : Low channel data  
ex. No. 47 -> 00 2F (2FH)  
No. 394 -> 01 8A (18AH),  
DTV No. 0 -> Don't care  
Data02 : 0x00 : Analogue Main  
0x10 : DTV Main  
0x20 : Radio

```
Ack [a][ ][Set ID][ ][OK/NG][Data][x]
```

Data Min: 00 to Max: 7DH

**21. Programme Add/Skip(Command: m b)**

- ▶ To set skip status for the current Programme.

```
Transmission [m][b][ ][Set ID][ ][Data][Cr]
```

Data 00 : Skip      01 : Add

```
Ack [b][ ][Set ID][ ][OK/NG][Data][x]
```

**22. Key(Command: m c)**

- ▶ To send IR remote key code.

```
Transmission [m][c][ ][Set ID][ ][Data][Cr]
```

Data Key code - Refer to page 103.

```
Ack [c][ ][Set ID][ ][OK/NG][Data][x]
```

**23. Input select (Command: x b)**

(Main Picture Input)

- To select input source for main picture.

Transmission [x][b][ ][Set ID][ ][Data][Cr]

Data Structure

MSB LSB

0	0	0	0	0	0	0	0	0
---	---	---	---	---	---	---	---	---

└ External Input ┘    └ Input Number ┘

External Input				Data
0	0	0	0	DTV
0	0	0	1	Analogue
0	0	1	0	AV
0	1	0	0	Component
0	1	1	0	RGB
0	1	1	1	HDMI
1	0	0	0	
1	0	0	1	
1	0	1	0	

Input Number				Data
0	0	0	0	Input1
0	0	0	1	Input2
0	0	1	0	Input3
0	0	1	1	Input4

Ack [b][ ][Set ID][ ][OK/NG][Data][x]

**\* Real data mapping**

00 : Step 0  
 ⋮  
 A : Step 10 (Set ID 10)  
 ⋮  
 F : Step 15 (Set ID 15)  
 10 : Step 16 (Set ID 16)  
 ⋮  
 64 : Step 100  
 ⋮  
 6E : Step 110  
 ⋮  
 73 : Step 115  
 74 : Step 116  
 ⋮  
 CF : Step 199  
 ⋮  
 FE : Step 254  
 FF : Step 255

# OPEN SOURCE LICENSE

## Open source software notice

Please be informed that LG Electronics products may contain open source software listed in the tables below.

License	Component
OpenSSL license	- openssl
MIT license	- libcurl - ncurses
expat license	- expat
Freetype license	- freetype
JPEG license	- libjpeg
Zlib/libpng license	- libmng - libpng - md5 checksum - tinyxml - zlib
X.net license	- libicu
BSD license	- strace - xySSL
RSA data security license	- MD5

LG Electronics products may also contain open source software listed as Components in the table below, and you may download the complete source code thereof free of charge, from LG Electronics website (<http://opensource.lge.com>) for a period of three (3) years from our last shipment of this product. Please be informed that the open source software is subject to the terms and conditions of the applicable open source licenses, which are provided to you hereinbelow.

License	Component
GNU GPL v2.0	- Linux kernel 2.6 - busybox - e2fsprogs - gdbserver - jfsutils - mtd-utils - procps - u-boot - udhcpc
GNU LGPL v2.1	- directFB - gconv - glibc
MPL 1.1	- nanox

## GNU GENERAL PUBLIC LICENSE

Version 2, June 1991

Copyright (C) 1989, 1991 Free Software Foundation, Inc.  
51 Franklin Street, Fifth Floor, Boston, MA 02110-1301, USA  
Everyone is permitted to copy and distribute verbatim copies  
of this license document, but changing it is not allowed.

### Preamble

The licenses for most software are designed to take away your freedom to share and change it. By contrast, the GNU General Public License is intended to guarantee your freedom to share and change free software—to make sure the software is free for all its users. This General Public License applies to most of the Free Software Foundation's software and to any other program whose authors commit to using it. (Some other Free Software Foundation software is covered by the GNU Lesser General Public License instead.) You can apply it to your programs, too.

When we speak of free software, we are referring to freedom, not price. Our General Public Licenses are designed to make sure that you have the freedom to distribute copies of free software (and charge for this service if you wish), that you receive source code or can get it if you want it, that you can change the software or use pieces of it in new free programs; and that you know you can do these things.

To protect your rights, we need to make restrictions that forbid anyone to deny you these rights or to ask you to surrender the rights. These restrictions translate to certain responsibilities for you if you distribute copies of the software, or if you modify it.

For example, if you distribute copies of such a program, whether gratis or for a fee, you must give the recipients all the rights that you have. You must make sure that they, too, receive or can get the source code. And you must show them these terms so they know their rights.

We protect your rights with two steps: (1) copyright the software, and (2) offer you this license which gives you legal permission to copy, distribute and/or modify the software.

Also, for each author's protection and ours, we want to make certain that everyone understands that there is no warranty for this free software. If the software is modified by someone else and passed on, we want its recipients to know that what they have is not the original, so that any problems introduced by others will not reflect on the original authors' reputations.

Finally, any free program is threatened constantly by software patents. We wish to avoid the danger that redistributors of a free program will individually obtain patent licenses, in effect making the program proprietary. To prevent this, we have made it clear that any patent must be licensed for everyone's free use or not licensed at all.

The precise terms and conditions for copying, distribution and modification follow.

### TERMS AND CONDITIONS FOR COPYING, DISTRIBUTION AND MODIFICATION

0. This License applies to any program or other work which contains a notice placed by the copyright holder saying it may be distributed under the terms of this General Public License. The "Program", below, refers to any such program or work, and a "work based on the Program" means either the Program or any derivative work under copyright law: that is to say, a work containing the Program or a portion of it, either verbatim or with modifications and/or translated into another language. (Hereinafter, translation is included without limitation in the term "modification".) Each licensee is addressed as "you".

Activities other than copying, distribution and modification are not covered by this License; they are outside its scope. The act of running the Program is not restricted, and the output from the Program is covered only if its contents constitute a work based on the Program (independent of having been made by running the Program). Whether that is true depends on what the Program does.

1. You may copy and distribute verbatim copies of the Program's source code as you receive it, in any medium, provided that you conspicuously and appropriately publish on each copy an appropriate copyright notice and disclaimer of warranty; keep intact all the notices that refer to this License and to the absence of any warranty; and give any other recipients of the Program a copy of this License along with the Program.

You may charge a fee for the physical act of transferring a copy, and you may at your option offer warranty protection in exchange for a fee.

2. You may modify your copy or copies of the Program or any portion of it, thus forming a work based on the Program, and copy and distribute such modifications or work under the terms of Section 1 above, provided that you also meet all of these conditions:

a) You must cause the modified files to carry prominent notices stating that you changed the files and the date of any change.

b) You must cause any work that you distribute or publish, that in whole or in part contains or is derived from the Program or any part thereof, to be licensed as a whole at no charge to all third parties under the terms of this License.

c) If the modified program normally reads commands interactively when run, you must cause it, when started running for such interactive use in the most ordinary way, to print or display an announcement including an appropriate copyright notice and a notice that there is no warranty (or else, saying that you provide a warranty) and that users may redistribute the program under these conditions, and telling the user how to view a copy of this License. (Exception: if the Program itself is interactive but does not normally print such an announcement, your work based on the Program is not required to print an announcement.)

These requirements apply to the modified work as a whole. If identifiable sections of that work are not derived from the Program, and can be reasonably considered independent and separate works in themselves, then this License, and its terms, do not apply to those sections when you distribute them as separate works. But when you distribute the same sections as part of a whole which is a work based on the Program, the distribution of the whole must be on the terms of this License, whose permissions for other licensees extend to the entire whole, and thus to each and every part regardless of who wrote it.

Thus, it is not the intent of this section to claim rights or contest your rights to work written entirely by you; rather, the intent is to exercise the right to control the distribution of derivative or collective works based on the Program.

In addition, mere aggregation of another work not based on the Program with the Program (or with a work based on the Program) on a volume of a storage or distribution medium does not bring the other work under the scope of this License.

3. You may copy and distribute the Program (or a work based on it, under Section 2) in object code or executable form under the terms of Sections 1 and 2 above provided that you also do one of the following:

a) Accompany it with the complete corresponding machine-readable source code, which must be distributed under the terms of Sections 1 and 2 above on a medium customarily used for software interchange; or,

b) Accompany it with a written offer, valid for at least three years, to give any third party, for a charge no more than your cost of physically performing source distribution, a complete machine-readable copy of the corresponding source code, to be distributed under the terms of Sections 1 and 2 above on a medium customarily used for software interchange; or,

c) Accompany it with the information you received as to the offer to distribute corresponding source code. (This alternative is allowed only for noncommercial distribution and only if you received the program in object code or executable form with such an offer, in accord with Subsection b above.)

The source code for a work means the preferred form of the work for making modifications to it. For an executable work, complete source code means all the source code for all modules it contains, plus any associated interface definition files, plus the scripts used to control compilation and installation of the executable. However, as a special exception, the source code distributed need not include anything that is normally distributed (in either source or binary form) with the major components (compiler, kernel, and so on) of the operating system on which the executable runs, unless that component itself accompanies the executable.

If distribution of executable or object code is made by offering access to copy from a designated place, then offering equivalent access to copy the source code from the same place counts as distribution of the source code, even though third parties are not compelled to copy the source along with the object code.

4. You may not copy, modify, sublicense, or distribute the Program except as expressly provided under this License. Any attempt otherwise to copy, modify, sublicense or distribute the Program is void, and will automatically terminate your rights under this License. However, parties who have received copies, or rights, from you under this License will not have their licenses terminated so long as such parties remain in full compliance.

5. You are not required to accept this License, since you have not signed it. However, nothing else grants you permission to modify or distribute the Program or its derivative works. These actions are prohibited by law if you do not accept this License. Therefore, by modifying or distributing the Program (or any work based on the Program), you indicate your acceptance of this License to do so, and all its terms and conditions for copying, distributing or modifying the Program or works based on it.

6. Each time you redistribute the Program (or any work based on the Program), the recipient automatically receives a license from the original licensor to copy, distribute or modify the Program subject to these terms and conditions. You may not impose any further restrictions on the recipients' exercise of the rights granted herein. You are not responsible for enforcing compliance by third parties to this License.

7. If, as a consequence of a court judgment or allegation of patent infringement or for any other reason (not limited to patent issues), conditions are imposed on you (whether by court order, agreement or otherwise) that contradict the conditions of this License, they do not excuse you from the conditions of this License. If you cannot distribute so as to satisfy simultaneously your obligations under this License and any other pertinent obligations, then as a consequence you may not distribute the Program at all. For example, if a patent license would not permit royalty-free redistribution of the Program by all those who receive copies directly or indirectly through you, then the only way you could satisfy both it and this License would be to refrain entirely from distribution of the Program.

If any portion of this section is held invalid or unenforceable under any particular circumstance, the balance of the section is intended to apply and the section as a whole is intended to apply in other circumstances.

It is not the purpose of this section to induce you to infringe any patents or other property right claims or to contest validity of any such claims; this section has the sole purpose of protecting the integrity of the free software distribution system, which is implemented by public license practices. Many people have made generous contributions to the wide range of software distributed through that system in reliance on consistent application of that system; it is up to the author/donor to decide if he or she is willing to distribute software through any other system and a licensee cannot impose that choice.

This section is intended to make thoroughly clear what is believed to be a consequence of the rest of this License.

8. If the distribution and/or use of the Program is restricted in certain countries either by patents or by copyrighted interfaces, the original copyright holder who places the Program under this License may add an explicit geographical distribution limitation excluding those countries, so that distribution is permitted only in or among countries not thus excluded. In such case, this License incorporates the limitation as if written in the body of this License.

9. The Free Software Foundation may publish revised and/or new versions of the General Public License from time to time. Such new versions will be similar in spirit to the present version, but may differ in detail to address new problems or concerns.

Each version is given a distinguishing version number. If the Program specifies a version number of this License which

applies to it and “any later version”, you have the option of following the terms and conditions either of that version or of any later version published by the Free Software Foundation. If the Program does not specify a version number of this License, you may choose any version ever published by the Free Software Foundation.

10. If you wish to incorporate parts of the Program into other free programs whose distribution conditions are different, write to the author to ask for permission. For software which is copyrighted by the Free Software Foundation, write to the Free Software Foundation; we sometimes make exceptions for this. Our decision will be guided by the two goals of preserving the free status of all derivatives of our free software and of promoting the sharing and reuse of software generally.

## NO WARRANTY

11. BECAUSE THE PROGRAM IS LICENSED FREE OF CHARGE, THERE IS NO WARRANTY FOR THE PROGRAM, TO THE EXTENT PERMITTED BY APPLICABLE LAW. EXCEPT WHEN OTHERWISE STATED IN WRITING THE COPYRIGHT HOLDERS AND/OR OTHER PARTIES PROVIDE THE PROGRAM “AS IS” WITHOUT WARRANTY OF ANY KIND, EITHER EXPRESSED OR IMPLIED, INCLUDING, BUT NOT LIMITED TO, THE IMPLIED WARRANTIES OF MERCHANTABILITY AND FITNESS FOR A PARTICULAR PURPOSE. THE ENTIRE RISK AS TO THE QUALITY AND PERFORMANCE OF THE PROGRAM IS WITH YOU. SHOULD THE PROGRAM PROVE DEFECTIVE, YOU ASSUME THE COST OF ALL NECESSARY SERVICING, REPAIR OR CORRECTION.

12. IN NO EVENT UNLESS REQUIRED BY APPLICABLE LAW OR AGREED TO IN WRITING WILL ANY COPYRIGHT HOLDER, OR ANY OTHER PARTY WHO MAY MODIFY AND/OR REDISTRIBUTE THE PROGRAM AS PERMITTED ABOVE, BE LIABLE TO YOU FOR DAMAGES, INCLUDING ANY GENERAL, SPECIAL, INCIDENTAL OR CONSEQUENTIAL DAMAGES ARISING OUT OF THE USE OR INABILITY TO USE THE PROGRAM (INCLUDING BUT NOT LIMITED TO LOSS OF DATA OR DATA BEING RENDERED INACCURATE OR LOSSES SUSTAINED BY YOU OR THIRD PARTIES OR A FAILURE OF THE PROGRAM TO OPERATE WITH ANY OTHER PROGRAMS), EVEN IF SUCH HOLDER OR OTHER PARTY HAS BEEN ADVISED OF THE POSSIBILITY OF SUCH DAMAGES.

## END OF TERMS AND CONDITIONS

# GNU Lesser General Public License

Version 2.1, February 1999

Copyright (C) 1991, 1999 Free Software Foundation, Inc. 59 Temple Place, Suite 330, Boston, MA 02111-1307 USA  
Everyone is permitted to copy and distribute verbatim copies of this license document, but changing it is not allowed.

[This is the first released version of the Lesser GPL. It also counts as the successor of the GNU Library Public License, version 2, hence the version number 2.1.]

## Preamble

The licenses for most software are designed to take away your freedom to share and change it. By contrast, the GNU General Public Licenses are intended to guarantee your freedom to share and change free software—to make sure the software is free for all its users.

This license, the Lesser General Public License, applies to some specially designated software packages—typically libraries—of the Free Software Foundation and other authors who decide to use it. You can use it too, but we suggest you first think carefully about whether this license or the ordinary General Public License is the better strategy to use in any particular case, based on the explanations below.

When we speak of free software, we are referring to freedom of use, not price. Our General Public Licenses are designed to make sure that you have the freedom to distribute copies of free software (and charge for this service if you wish); that you receive source code or can get it if you want it; that you can change the software and use pieces of it in new free programs; and that you are informed that you can do these things.

To protect your rights, we need to make restrictions that forbid distributors to deny you these rights or to ask you to sur-

render these rights. These restrictions translate to certain responsibilities for you if you distribute copies of the library or if you modify it.

For example, if you distribute copies of the library, whether gratis or for a fee, you must give the recipients all the rights that we gave you. You must make sure that they, too, receive or can get the source code. If you link other code with the library, you must provide complete object files to the recipients, so that they can relink them with the library after making changes to the library and recompiling it. And you must show them these terms so they know their rights.

We protect your rights with a two-step method: (1) we copyright the library, and (2) we offer you this license, which gives you legal permission to copy, distribute and/or modify the library.

To protect each distributor, we want to make it very clear that there is no warranty for the free library. Also, if the library is modified by someone else and passed on, the recipients should know that what they have is not the original version, so that the original author's reputation will not be affected by problems that might be introduced by others.

Finally, software patents pose a constant threat to the existence of any free program. We wish to make sure that a company cannot effectively restrict the users of a free program by obtaining a restrictive license from a patent holder. Therefore, we insist that any patent license obtained for a version of the library must be consistent with the full freedom of use specified in this license.

Most GNU software, including some libraries, is covered by the ordinary GNU General Public License. This license, the GNU Lesser General Public License, applies to certain designated libraries, and is quite different from the ordinary General Public License. We use this license for certain libraries in order to permit linking those libraries into non-free programs.

When a program is linked with a library, whether statically or using a shared library, the combination of the two is legally speaking a combined work, a derivative of the original library. The ordinary General Public License therefore permits such linking only if the entire combination fits its criteria of freedom. The Lesser General Public License permits more lax criteria for linking other code with the library.

We call this license the "Lesser" General Public License because it does Less to protect the user's freedom than the ordinary General Public License. It also provides other free software developers Less of an advantage over competing non-free programs. These disadvantages are the reason we use the ordinary General Public License for many libraries. However, the Lesser license provides advantages in certain special circumstances.

For example, on rare occasions, there may be a special need to encourage the widest possible use of a certain library, so that it becomes a de-facto standard. To achieve this, non-free programs must be allowed to use the library. A more frequent case is that a free library does the same job as widely used non-free libraries. In this case, there is little to gain by limiting the free library to free software only, so we use the Lesser General Public License.

In other cases, permission to use a particular library in non-free programs enables a greater number of people to use a large body of free software. For example, permission to use the GNU C Library in non-free programs enables many more people to use the whole GNU operating system, as well as its variant, the GNU/Linux operating system.

Although the Lesser General Public License is Less protective of the users' freedom, it does ensure that the user of a program that is linked with the Library has the freedom and the wherewithal to run that program using a modified version of the Library.

The precise terms and conditions for copying, distribution and modification follow. Pay close attention to the difference between a "work based on the library" and a "work that uses the library". The former contains code derived from the library, whereas the latter must be combined with the library in order to run.

## **TERMS AND CONDITIONS FOR COPYING, DISTRIBUTION AND MODIFICATION**

0. This License Agreement applies to any software library or other program which contains a notice placed by the copyright holder or other authorized party saying it may be distributed under the terms of this Lesser General Public License (also called "this License"). Each licensee is addressed as "you".

A “library” means a collection of software functions and/or data prepared so as to be conveniently linked with application programs (which use some of those functions and data) to form executables.

The “Library”, below, refers to any such software library or work which has been distributed under these terms. A “work based on the Library” means either the Library or any derivative work under copyright law: that is to say, a work containing the Library or a portion of it, either verbatim or with modifications and/or translated straightforwardly into another language. (Hereinafter, translation is included without limitation in the term “modification”.)

“Source code” for a work means the preferred form of the work for making modifications to it. For a library, complete source code means all the source code for all modules it contains, plus any associated interface definition files, plus the scripts used to control compilation and installation of the library.

Activities other than copying, distribution and modification are not covered by this License; they are outside its scope. The act of running a program using the Library is not restricted, and output from such a program is covered only if its contents constitute a work based on the Library (independent of the use of the Library in a tool for writing it). Whether that is true depends on what the Library does and what the program that uses the Library does.

1. You may copy and distribute verbatim copies of the Library's complete source code as you receive it, in any medium, provided that you conspicuously and appropriately publish on each copy an appropriate copyright notice and disclaimer of warranty; keep intact all the notices that refer to this License and to the absence of any warranty; and distribute a copy of this License along with the Library.

You may charge a fee for the physical act of transferring a copy, and you may at your option offer warranty protection in exchange for a fee.

2. You may modify your copy or copies of the Library or any portion of it, thus forming a work based on the Library, and copy and distribute such modifications or work under the terms of Section 1 above, provided that you also meet all of these conditions:

a) The modified work must itself be a software library.

b) You must cause the files modified to carry prominent notices stating that you changed the files and the date of any change.

c) You must cause the whole of the work to be licensed at no charge to all third parties under the terms of this License.

d) If a facility in the modified Library refers to a function or a table of data to be supplied by an application program that uses the facility, other than as an argument passed when the facility is invoked, then you must make a good faith effort to ensure that, in the event an application does not supply such function or table, the facility still operates, and performs whatever part of its purpose remains meaningful.

(For example, a function in a library to compute square roots has a purpose that is entirely well-defined independent of the application. Therefore, Subsection 2d requires that any application-supplied function or table used by this function must be optional: if the application does not supply it, the square root function must still compute square roots.)

These requirements apply to the modified work as a whole. If identifiable sections of that work are not derived from the Library, and can be reasonably considered independent and separate works in themselves, then this License, and its terms, do not apply to those sections when you distribute them as separate works. But when you distribute the same sections as part of a whole which is a work based on the Library, the distribution of the whole must be on the terms of this License, whose permissions for other licensees extend to the entire whole, and thus to each and every part regardless of who wrote it.

Thus, it is not the intent of this section to claim rights or contest your rights to work written entirely by you; rather, the intent is to exercise the right to control the distribution of derivative or collective works based on the Library.

In addition, mere aggregation of another work not based on the Library with the Library (or with a work based on the

Library) on a volume of a storage or distribution medium does not bring the other work under the scope of this License.

**3.** You may opt to apply the terms of the ordinary GNU General Public License instead of this License to a given copy of the Library. To do this, you must alter all the notices that refer to this License, so that they refer to the ordinary GNU General Public License, version 2, instead of to this License. (If a newer version than version 2 of the ordinary GNU General Public License has appeared, then you can specify that version instead if you wish.) Do not make any other change in these notices.

Once this change is made in a given copy, it is irreversible for that copy, so the ordinary GNU General Public License applies to all subsequent copies and derivative works made from that copy.

This option is useful when you wish to copy part of the code of the Library into a program that is not a library.

**4.** You may copy and distribute the Library (or a portion or derivative of it, under Section 2) in object code or executable form under the terms of Sections 1 and 2 above provided that you accompany it with the complete corresponding machine-readable source code, which must be distributed under the terms of Sections 1 and 2 above on a medium customarily used for software interchange.

If distribution of object code is made by offering access to copy from a designated place, then offering equivalent access to copy the source code from the same place satisfies the requirement to distribute the source code, even though third parties are not compelled to copy the source along with the object code.

**5.** A program that contains no derivative of any portion of the Library, but is designed to work with the Library by being compiled or linked with it, is called a “work that uses the Library”. Such a work, in isolation, is not a derivative work of the Library, and therefore falls outside the scope of this License.

However, linking a “work that uses the Library” with the Library creates an executable that is a derivative of the Library (because it contains portions of the Library), rather than a “work that uses the library”. The executable is therefore covered by this License. Section 6 states terms for distribution of such executables.

When a “work that uses the Library” uses material from a header file that is part of the Library, the object code for the work may be a derivative work of the Library even though the source code is not. Whether this is true is especially significant if the work can be linked without the Library, or if the work is itself a library. The threshold for this to be true is not precisely defined by law.

If such an object file uses only numerical parameters, data structure layouts and accessors, and small macros and small inline functions (ten lines or less in length), then the use of the object file is unrestricted, regardless of whether it is legally a derivative work. (Executables containing this object code plus portions of the Library will still fall under Section 6.)

Otherwise, if the work is a derivative of the Library, you may distribute the object code for the work under the terms of Section 6. Any executables containing that work also fall under Section 6, whether or not they are linked directly with the Library itself.

**6.** As an exception to the Sections above, you may also combine or link a “work that uses the Library” with the Library to produce a work containing portions of the Library, and distribute that work under terms of your choice, provided that the terms permit modification of the work for the customer’s own use and reverse engineering for debugging such modifications.

You must give prominent notice with each copy of the work that the Library is used in it and that the Library and its use are covered by this License. You must supply a copy of this License. If the work during execution displays copyright notices, you must include the copyright notice for the Library among them, as well as a reference directing the user to the copy of this License. Also, you must do one of these things:

a) Accompany the work with the complete corresponding machine-readable source code for the Library including whatever changes were used in the work (which must be distributed under Sections 1 and 2 above); and, if the work is an executable linked with the Library, with the complete machine-readable “work that uses the Library”, as object code and/

or source code, so that the user can modify the Library and then relink to produce a modified executable containing the modified Library. (It is understood that the user who changes the contents of definitions files in the Library will not necessarily be able to recompile the application to use the modified definitions.)

b) Use a suitable shared library mechanism for linking with the Library. A suitable mechanism is one that (1) uses at run time a copy of the library already present on the user's computer system, rather than copying library functions into the executable, and (2) will operate properly with a modified version of the library, if the user installs one, as long as the modified version is interface-compatible with the version that the work was made with.

c) Accompany the work with a written offer, valid for at least three years, to give the same user the materials specified in Subsection 6a, above, for a charge no more than the cost of performing this distribution.

d) If distribution of the work is made by offering access to copy from a designated place, offer equivalent access to copy the above specified materials from the same place.

e) Verify that the user has already received a copy of these materials or that you have already sent this user a copy.

For an executable, the required form of the "work that uses the Library" must include any data and utility programs needed for reproducing the executable from it. However, as a special exception, the materials to be distributed need not include anything that is normally distributed (in either source or binary form) with the major components (compiler, kernel, and so on) of the operating system on which the executable runs, unless that component itself accompanies the executable.

It may happen that this requirement contradicts the license restrictions of other proprietary libraries that do not normally accompany the operating system. Such a contradiction means you cannot use both them and the Library together in an executable that you distribute.

**7.** You may place library facilities that are a work based on the Library side-by-side in a single library together with other library facilities not covered by this License, and distribute such a combined library, provided that the separate distribution of the work based on the Library and of the other library facilities is otherwise permitted, and provided that you do these two things:

a) Accompany the combined library with a copy of the same work based on the Library, uncombined with any other library facilities. This must be distributed under the terms of the Sections above.

b) Give prominent notice with the combined library of the fact that part of it is a work based on the Library, and explaining where to find the accompanying uncombined form of the same work.

**8.** You may not copy, modify, sublicense, link with, or distribute the Library except as expressly provided under this License. Any attempt otherwise to copy, modify, sublicense, link with, or distribute the Library is void, and will automatically terminate your rights under this License. However, parties who have received copies, or rights, from you under this License will not have their licenses terminated so long as such parties remain in full compliance.

**9.** You are not required to accept this License, since you have not signed it. However, nothing else grants you permission to modify or distribute the Library or its derivative works. These actions are prohibited by law if you do not accept this License. Therefore, by modifying or distributing the Library (or any work based on the Library), you indicate your acceptance of this License to do so, and all its terms and conditions for copying, distributing or modifying the Library or works based on it.

**10.** Each time you redistribute the Library (or any work based on the Library), the recipient automatically receives a license from the original licensor to copy, distribute, link with or modify the Library subject to these terms and conditions. You may not impose any further restrictions on the recipients' exercise of the rights granted herein. You are not responsible for enforcing compliance by third parties with this License.

**11.** If, as a consequence of a court judgment or allegation of patent infringement or for any other reason (not limited to patent issues), conditions are imposed on you (whether by court order, agreement or otherwise) that contradict the conditions of this License, they do not excuse you from the conditions of this License. If you cannot distribute so as to satis-

fy simultaneously your obligations under this License and any other pertinent obligations, then as a consequence you may not distribute the Library at all. For example, if a patent license would not permit royalty-free redistribution of the Library by all those who receive copies directly or indirectly through you, then the only way you could satisfy both it and this License would be to refrain entirely from distribution of the Library.

If any portion of this section is held invalid or unenforceable under any particular circumstance, the balance of the section is intended to apply, and the section as a whole is intended to apply in other circumstances.

It is not the purpose of this section to induce you to infringe any patents or other property right claims or to contest validity of any such claims; this section has the sole purpose of protecting the integrity of the free software distribution system which is implemented by public license practices. Many people have made generous contributions to the wide range of software distributed through that system in reliance on consistent application of that system; it is up to the author/donor to decide if he or she is willing to distribute software through any other system and a licensee cannot impose that choice.

This section is intended to make thoroughly clear what is believed to be a consequence of the rest of this License.

**12.** If the distribution and/or use of the Library is restricted in certain countries either by patents or by copyrighted interfaces, the original copyright holder who places the Library under this License may add an explicit geographical distribution limitation excluding those countries, so that distribution is permitted only in or among countries not thus excluded. In such case, this License incorporates the limitation as if written in the body of this License.

**13.** The Free Software Foundation may publish revised and/or new versions of the Lesser General Public License from time to time. Such new versions will be similar in spirit to the present version, but may differ in detail to address new problems or concerns.

Each version is given a distinguishing version number. If the Library specifies a version number of this License which applies to it and “any later version”, you have the option of following the terms and conditions either of that version or of any later version published by the Free Software Foundation. If the Library does not specify a license version number, you may choose any version ever published by the Free Software Foundation.

**14.** If you wish to incorporate parts of the Library into other free programs whose distribution conditions are incompatible with these, write to the author to ask for permission. For software which is copyrighted by the Free Software Foundation, write to the Free Software Foundation; we sometimes make exceptions for this. Our decision will be guided by the two goals of preserving the free status of all derivatives of our free software and of promoting the sharing and reuse of software generally.

## **NO WARRANTY**

**15.** BECAUSE THE LIBRARY IS LICENSED FREE OF CHARGE, THERE IS NO WARRANTY FOR THE LIBRARY, TO THE EXTENT PERMITTED BY APPLICABLE LAW. EXCEPT WHEN OTHERWISE STATED IN WRITING THE COPYRIGHT HOLDERS AND/OR OTHER PARTIES PROVIDE THE LIBRARY “AS IS” WITHOUT WARRANTY OF ANY KIND, EITHER EXPRESSED OR IMPLIED, INCLUDING, BUT NOT LIMITED TO, THE IMPLIED WARRANTIES OF MERCHANTABILITY AND FITNESS FOR A PARTICULAR PURPOSE. THE ENTIRE RISK AS TO THE QUALITY AND PERFORMANCE OF THE LIBRARY IS WITH YOU. SHOULD THE LIBRARY PROVE DEFECTIVE, YOU ASSUME THE COST OF ALL NECESSARY SERVICING, REPAIR OR CORRECTION.

**16.** IN NO EVENT UNLESS REQUIRED BY APPLICABLE LAW OR AGREED TO IN WRITING WILL ANY COPYRIGHT HOLDER, OR ANY OTHER PARTY WHO MAY MODIFY AND/OR REDISTRIBUTE THE LIBRARY AS PERMITTED ABOVE, BE LIABLE TO YOU FOR DAMAGES, INCLUDING ANY GENERAL, SPECIAL, INCIDENTAL OR CONSEQUENTIAL DAMAGES ARISING OUT OF THE USE OR INABILITY TO USE THE LIBRARY (INCLUDING BUT NOT LIMITED TO LOSS OF DATA OR DATA BEING RENDERED INACCURATE OR LOSSES SUSTAINED BY YOU OR THIRD PARTIES OR A FAILURE OF THE LIBRARY TO OPERATE WITH ANY OTHER SOFTWARE), EVEN IF SUCH HOLDER OR OTHER PARTY HAS BEEN ADVISED OF THE POSSIBILITY OF SUCH DAMAGES.

## END OF TERMS AND CONDITIONS

### How to Apply These Terms to Your New Libraries

If you develop a new library, and you want it to be of the greatest possible use to the public, we recommend making it free software that everyone can redistribute and change. You can do so by permitting redistribution under these terms (or, alternatively, under the terms of the ordinary General Public License).

To apply these terms, attach the following notices to the library. It is safest to attach them to the start of each source file to most effectively convey the exclusion of warranty; and each file should have at least the “copyright” line and a pointer to where the full notice is found.

<one line to give the library’s name and an idea of what it does.> Copyright (C) <year> <name of author>

This library is free software; you can redistribute it and/or modify it under the terms of the GNU Lesser General Public License as published by the Free Software Foundation; either version 2.1 of the License, or (at your option) any later version.

This library is distributed in the hope that it will be useful, but WITHOUT ANY WARRANTY; without even the implied warranty of MERCHANTABILITY or FITNESS FOR A PARTICULAR PURPOSE. See the GNU Lesser General Public License for more details.

You should have received a copy of the GNU Lesser General Public License along with this library; if not, write to the Free Software Foundation, Inc., 59 Temple Place, Suite 330, Boston, MA 02111-1307 USA

Also add information on how to contact you by electronic and paper mail.

You should also get your employer (if you work as a programmer) or your school, if any, to sign a “copyright disclaimer” for the library, if necessary. Here is a sample; alter the names:

Yoyodyne, Inc., hereby disclaims all copyright interest in the library ‘Frob’ (a library for tweaking knobs) written by James Random Hacker.

signature of Ty Coon, 1 April 1990  
Ty Coon, President of Vice

That’s all there is to it!

## Mozilla Public License 1.1 (MPL 1.1)

### 1. Definitions.

#### 1.0.1. “Commercial Use”

means distribution or otherwise making the Covered Code available to a third party.

#### 1.1. “Contributor”

means each entity that creates or contributes to the creation of Modifications.

#### 1.2. “Contributor Version”

means the combination of the Original Code, prior Modifications used by a Contributor, and the Modifications made by that particular Contributor.

#### 1.3. “Covered Code”

means the Original Code or Modifications or the combination of the Original Code and Modifications, in each case including portions thereof.

#### 1.4. “Electronic Distribution Mechanism”

means a mechanism generally accepted in the software development community for the electronic transfer of data.

#### 1.5. “Executable”

means Covered Code in any form other than Source Code.

#### 1.6. “Initial Developer”

means the individual or entity identified as the Initial Developer in the Source Code notice required by Exhibit A.

#### 1.7. “Larger Work”

means a work which combines Covered Code or portions thereof with code not governed by the terms of this License.

#### 1.8. “License”

means this document.

#### 1.8.1. “Licensable”

means having the right to grant, to the maximum extent possible, whether at the time of the initial grant or subsequently acquired, any and all of the rights conveyed herein.

#### 1.9. “Modifications”

means any addition to or deletion from the substance or structure of either the Original Code or any previous Modifications. When Covered Code is released as a series of files, a Modification is:

(a) Any addition to or deletion from the contents of a file containing Original Code or previous Modifications.

(b) Any new file that contains any part of the Original Code or previous Modifications.

#### 1.10. “Original Code”

means Source Code of computer software code which is described in the Source Code notice required by Exhibit A as Original Code, and which, at the time of its release under this License is not already Covered Code governed by this License.

#### 1.10.1. “Patent Claims”

means any patent claim(s), now owned or hereafter acquired, including without limitation, method, process, and apparatus claims, in any patent Licensable by grantor.

#### 1.11. “Source Code”

means the preferred form of the Covered Code for making modifications to it, including all modules it contains, plus any associated interface definition files, scripts used to control compilation and installation of an Executable, or source code differential comparisons against either the Original Code or another well known, available Covered Code of the Contributor's choice. The Source Code can be in a compressed or archival form, provided the appropriate decompression or de-archiving software is widely available for no charge.

#### **1.12. "You" (or "Your")**

means an individual or a legal entity exercising rights under, and complying with all of the terms of, this License or a future version of this License issued under Section 6.1. For legal entities, "You" includes any entity which controls, is controlled by, or is under common control with You. For purposes of this definition, "control" means (a) the power, direct or indirect, to cause the direction or management of such entity, whether by contract or otherwise, or (b) ownership of more than fifty percent (50%) of the outstanding shares or beneficial ownership of such entity.

## **2. Source Code License.**

### **2.1. The Initial Developer Grant.**

The Initial Developer hereby grants You a world-wide, royalty-free, non-exclusive license, subject to third party intellectual property claims:

(a) under intellectual property rights (other than patent or trademark) Licensable by Initial Developer to use, reproduce, modify, display, perform, sublicense and distribute the Original Code (or portions thereof) with or without Modifications, and/or as part of a Larger Work; and

(b) under Patents Claims infringed by the making, using or selling of Original Code, to make, have made, use, practice, sell, and offer for sale, and/or otherwise dispose of the Original Code (or portions thereof).

(c) the licenses granted in this Section 2.1(a) and (b) are effective on the date Initial Developer first distributes Original Code under the terms of this License.

(d) Notwithstanding Section 2.1(b) above, no patent license is granted: 1) for code that You delete from the Original Code; 2) separate from the Original Code; or 3) for infringements caused by: i) the modification of the Original Code or ii) the combination of the Original Code with other software or devices.

### **2.2. Contributor Grant.**

Subject to third party intellectual property claims, each Contributor hereby grants You a world-wide, royalty-free, non-exclusive license

(a) under intellectual property rights (other than patent or trademark) Licensable by Contributor, to use, reproduce, modify, display, perform, sublicense and distribute the Modifications created by such Contributor (or portions thereof) either on an unmodified basis, with other Modifications, as Covered Code and/or as part of a Larger Work; and

(b) under Patent Claims infringed by the making, using, or selling of Modifications made by that Contributor either alone and/or in combination with its Contributor Version (or portions of such combination), to make, use, sell, offer for sale, have made, and/or otherwise dispose of: 1) Modifications made by that Contributor (or portions thereof); and 2) the combination of Modifications made by that Contributor with its Contributor Version (or portions of such combination).

(c) the licenses granted in Sections 2.2(a) and 2.2(b) are effective on the date Contributor first makes Commercial Use of the Covered Code.

(d) Notwithstanding Section 2.2(b) above, no patent license is granted: 1) for any code that Contributor has deleted from the Contributor Version; 2) separate from the Contributor Version; 3) for infringements caused by: i) third party modifications of Contributor Version or ii) the combination of Modifications made by that Contributor with other software (except as part of the Contributor Version) or other devices; or 4) under Patent Claims infringed by Covered Code in the absence of Modifications made by that Contributor.

## **3. Distribution Obligations.**

### 3.1. Application of License.

The Modifications which You create or to which You contribute are governed by the terms of this License, including without limitation Section 2.2. The Source Code version of Covered Code may be distributed only under the terms of this License or a future version of this License released under Section 6.1, and You must include a copy of this License with every copy of the Source Code You distribute. You may not offer or impose any terms on any Source Code version that alters or restricts the applicable version of this License or the recipients' rights hereunder. However, You may include an additional document offering the additional rights described in Section 3.5.

### 3.2. Availability of Source Code.

Any Modification which You create or to which You contribute must be made available in Source Code form under the terms of this License either on the same media as an Executable version or via an accepted Electronic Distribution Mechanism to anyone to whom you made an Executable version available; and if made available via Electronic Distribution Mechanism, must remain available for at least twelve (12) months after the date it initially became available, or at least six (6) months after a subsequent version of that particular Modification has been made available to such recipients. You are responsible for ensuring that the Source Code version remains available even if the Electronic Distribution Mechanism is maintained by a third party.

### 3.3. Description of Modifications.

You must cause all Covered Code to which You contribute to contain a file documenting the changes You made to create that Covered Code and the date of any change. You must include a prominent statement that the Modification is derived, directly or indirectly, from Original Code provided by the Initial Developer and including the name of the Initial Developer in (a) the Source Code, and (b) in any notice in an Executable version or related documentation in which You describe the origin or ownership of the Covered Code.

### 3.4. Intellectual Property Matters

#### (a) Third Party Claims.

If Contributor has knowledge that a license under a third party's intellectual property rights is required to exercise the rights granted by such Contributor under Sections 2.1 or 2.2, Contributor must include a text file with the Source Code distribution titled "LEGAL" which describes the claim and the party making the claim in sufficient detail that a recipient will know whom to contact. If Contributor obtains such knowledge after the Modification is made available as described in Section 3.2, Contributor shall promptly modify the LEGAL file in all copies Contributor makes available thereafter and shall take other steps (such as notifying appropriate mailing lists or newsgroups) reasonably calculated to inform those who received the Covered Code that new knowledge has been obtained.

#### (b) Contributor APIs.

If Contributor's Modifications include an application programming interface and Contributor has knowledge of patent licenses which are reasonably necessary to implement that API, Contributor must also include this information in the LEGAL file.

#### (c) Representations.

Contributor represents that, except as disclosed pursuant to Section 3.4(a) above, Contributor believes that Contributor's Modifications are Contributor's original creation(s) and/or Contributor has sufficient rights to grant the rights conveyed by this License.

### 3.5. Required Notices.

You must duplicate the notice in Exhibit A in each file of the Source Code. If it is not possible to put such notice in a particular

Source Code file due to its structure, then You must include such notice in a location (such as a relevant directory) where a user would be likely to look for such a notice. If You created one or more Modification(s) You may add your name as a Contributor to the notice described in Exhibit A. You must also duplicate this License in any documentation for the Source Code where You describe recipients' rights or ownership rights relating to Covered Code. You may choose to offer, and to charge a fee for, warranty, support, indemnity or liability obligations to one or more recipients of Covered Code. However, You may do so only on Your own behalf, and not on behalf of the Initial Developer or any Contributor You must make it absolutely clear than any such warranty, support, indemnity or liability obligation is offered by You alone, and You hereby agree to indemnify the Initial Developer and every Contributor for any liability incurred by the Initial Developer or such Contributor as a result of warranty, support, indemnity or liability terms You offer.

### 3.6. Distribution of Executable Versions.

You may distribute Covered Code in Executable form only if the requirements of Section 3.1-3.5 have been met for that Covered Code, and if You include a notice stating that the Source Code version of the Covered Code is available under the terms of this License, including a description of how and where You have fulfilled the obligations of Section 3.2. The notice must be conspicuously included in any notice in an Executable version, related documentation or collateral in which You describe recipients' rights relating to the Covered Code. You may distribute the Executable version of Covered Code or ownership rights under a license of Your choice, which may contain terms different from this License, provided that You are in compliance with the terms of this License and that the license for the Executable version does not attempt to limit or alter the recipient's rights in the Source Code version from the rights set forth in this License. If You distribute the Executable version under a different license You must make it absolutely clear that any terms which differ from this License are offered by You alone, not by the Initial Developer or any Contributor. You hereby agree to indemnify the Initial Developer and every Contributor for any liability incurred by the Initial Developer or such Contributor as a result of any such terms You offer.

### 3.7. Larger Works.

You may create a Larger Work by combining Covered Code with other code not governed by the terms of this License and distribute the Larger Work as a single product. In such a case, You must make sure the requirements of this License are fulfilled for the Covered Code.

### 4. Inability to Comply Due to Statute or Regulation.

If it is impossible for You to comply with any of the terms of this License with respect to some or all of the Covered Code due to statute, judicial order, or regulation then You must: (a) comply with the terms of this License to the maximum extent possible; and (b) describe the limitations and the code they affect. Such description must be included in the LEGAL file described in Section 3.4 and must be included with all distributions of the Source Code. Except to the extent prohibited by statute or regulation, such description must be sufficiently detailed for a recipient of ordinary skill to be able to understand it.

### 5. Application of this License.

This License applies to code to which the Initial Developer has attached the notice in Exhibit A and to related Covered Code.

### 6. Versions of the License.

#### 6.1. New Versions.

Netscape Communications Corporation ("Netscape") may publish revised and/or new versions of the License from time to time. Each version will be given a distinguishing version number.

#### 6.2. Effect of New Versions.

Once Covered Code has been published under a particular version of the License, You may always continue to use it under the terms of that version. You may also choose to use such Covered Code under the terms of any subsequent version of the License published by Netscape. No one other than Netscape has the right to modify the terms applicable to Covered Code created under this License.

#### 6.3. Derivative Works.

If You create or use a modified version of this License (which you may only do in order to apply it to code which is not already Covered Code governed by this License), You must (a) rename Your license so that the phrases "Mozilla", "MOZILLAPL", "MOZPL", "Netscape", "MPL", "NPL" or any confusingly similar phrase do not appear in your license (except to note that your license differs from this License) and (b) otherwise make it clear that Your version of the license contains terms which differ from the Mozilla Public License and Netscape Public License. (Filling in the name of the Initial Developer, Original Code or Contributor in the notice described in Exhibit A shall not of themselves be deemed to be modifications of this License.)

### 7. DISCLAIMER OF WARRANTY.

**COVERED CODE IS PROVIDED UNDER THIS LICENSE ON AN "AS IS" BASIS, WITHOUT WARRANTY OF ANY KIND, EITHER EXPRESSED OR IMPLIED, INCLUDING, WITHOUT LIMITATION, WARRANTIES THAT THE COVERED CODE IS FREE OF DEFECTS, MERCHANTABILITY, FIT FOR A PARTICULAR PURPOSE OR NON-INFRINGEMENT. THE ENTIRE RISK AS TO THE QUALITY AND PERFORMANCE OF THE COVERED CODE IS WITH**

**YOU. SHOULD ANY COVERED CODE PROVE DEFECTIVE IN ANY RESPECT, YOU (NOT THE INITIAL DEVELOPER OR ANY OTHER CONTRIBUTOR) ASSUME THE COST OF ANY NECESSARY SERVICING, REPAIR OR CORRECTION. THIS DISCLAIMER OF WARRANTY CONSTITUTES AN ESSENTIAL PART OF THIS LICENSE. NO USE OF ANY COVERED CODE IS AUTHORIZED HEREUNDER EXCEPT UNDER THIS DISCLAIMER.**

## **8. TERMINATION.**

8.1. This License and the rights granted hereunder will terminate automatically if You fail to comply with terms herein and fail

to cure such breach within 30 days of becoming aware of the breach. All sublicenses to the Covered Code which are properly granted shall survive any termination of this License. Provisions which, by their nature, must remain in effect beyond the termination of this License shall survive.

8.2. If You initiate litigation by asserting a patent infringement claim (excluding declaratory judgment actions) against Initial Developer or a Contributor (the Initial Developer or Contributor against whom You file such action is referred to as "Participant") alleging that:

(a) such Participant's Contributor Version directly or indirectly infringes any patent, then any and all rights granted by such Participant to You under Sections 2.1 and/or 2.2 of this License shall, upon 60 days notice from Participant terminate prospectively, unless if within 60 days after receipt of notice You either: (i) agree in writing to pay Participant a mutually agreeable reasonable royalty for Your past and future use of Modifications made by such Participant, or (ii) withdraw Your litigation claim with respect to the Contributor Version against such Participant. If within 60 days of notice, a reasonable royalty and payment arrangement are not mutually agreed upon in writing by the parties or the litigation claim is not withdrawn, the rights granted by Participant to You under Sections 2.1 and/or 2.2 automatically terminate at the expiration of the 60 day notice period specified above.

(b) any software, hardware, or device, other than such Participant's Contributor Version, directly or indirectly infringes any patent, then any rights granted to You by such Participant under Sections 2.1(b) and 2.2(b) are revoked effective as of the date You first made, used, sold, distributed, or had made, Modifications made by that Participant.

8.3. If You assert a patent infringement claim against Participant alleging that such Participant's Contributor Version directly or indirectly infringes any patent where such claim is resolved (such as by license or settlement) prior to the initiation of patent infringement litigation, then the reasonable value of the licenses granted by such Participant under Sections 2.1 or 2.2 shall be taken into account in determining the amount or value of any payment or license. 8.4. In the event of termination under Sections 8.1 or 8.2 above, all end user license agreements (excluding distributors and resellers) which have been validly granted by You or any distributor hereunder prior to termination shall survive termination.

## **9. LIMITATION OF LIABILITY.**

**UNDER NO CIRCUMSTANCES AND UNDER NO LEGAL THEORY, WHETHER TORT (INCLUDING NEGLIGENCE), CONTRACT, OR OTHERWISE, SHALL YOU, THE INITIAL DEVELOPER, ANY OTHER CONTRIBUTOR, OR ANY DISTRIBUTOR OF COVERED CODE, OR ANY SUPPLIER OF ANY OF SUCH PARTIES, BE LIABLE TO ANY PERSON FOR ANY INDIRECT, SPECIAL, INCIDENTAL, OR CONSEQUENTIAL DAMAGES OF ANY CHARACTER INCLUDING, WITHOUT LIMITATION, DAMAGES FOR LOSS OF GOODWILL, WORK STOPPAGE, COMPUTER FAILURE OR MALFUNCTION, OR ANY AND ALL OTHER COMMERCIAL DAMAGES OR LOSSES, EVEN IF SUCH PARTY SHALL HAVE BEEN INFORMED OF THE POSSIBILITY OF SUCH DAMAGES. THIS LIMITATION OF LIABILITY SHALL NOT APPLY TO LIABILITY FOR DEATH OR PERSONAL INJURY RESULTING FROM SUCH PARTY'S NEGLIGENCE TO THE EXTENT APPLICABLE LAW PROHIBITS SUCH LIMITATION. SOME JURISDICTIONS DO NOT ALLOW THE EXCLUSION OR LIMITATION OF INCIDENTAL OR CONSEQUENTIAL DAMAGES, SO THIS EXCLUSION AND LIMITATION MAY NOT APPLY TO YOU.**

## **10. U.S. GOVERNMENT END USERS.**

The Covered Code is a "commercial item," as that term is defined in 48 C.F.R. 2.101 (Oct. 1995), consisting of "commercial computer software" and "commercial computer software documentation," as such terms are used in 48 C.F.R. 12.212 (Sept. 1995). Consistent with 48 C.F.R. 12.212 and 48 C.F.R. 227.7202-1 through 227.7202-4 (June 1995), all U.S. Government End Users acquire Covered Code with only those rights set forth herein.

## **11. MISCELLANEOUS.**

This License represents the complete agreement concerning subject matter hereof. If any provision of this License is

held to be unenforceable, such provision shall be reformed only to the extent necessary to make it enforceable. This License shall be governed by California law provisions (except to the extent applicable law, if any, provides otherwise), excluding its conflict-of-law provisions. With respect to disputes in which at least one party is a citizen of, or an entity chartered or registered to do business in the United States of America, any litigation relating to this License shall be subject to the jurisdiction of the Federal Courts of the Northern District of California, with venue lying in Santa Clara County, California, with the losing party responsible for costs, including without limitation, court costs and reasonable attorneys' fees and expenses. The application of the United Nations Convention on Contracts for the International Sale of Goods is expressly excluded. Any law or regulation which provides that the language of a contract shall be construed against the drafter shall not apply to this License.

## 12. RESPONSIBILITY FOR CLAIMS.

As between Initial Developer and the Contributors, each party is responsible for claims and damages arising, directly or indirectly, out of its utilization of rights under this License and You agree to work with Initial Developer and Contributors to distribute such responsibility on an equitable basis. Nothing herein is intended or shall be deemed to constitute any admission of liability.

## 13. MULTIPLE-LICENSED CODE.

Initial Developer may designate portions of the Covered Code as Multiple-Licensed. Multiple-Licensed means that the Initial Developer permits you to utilize portions of the Covered Code under Your choice of the MPL or the alternative licenses, if any, specified by the Initial Developer in the file described in Exhibit A.

### EXHIBIT A -Mozilla Public License.

``The contents of this file are subject to the Mozilla Public License Version 1.1 (the "License"); you may not use this file except in compliance with the License. You may obtain a copy of the License at <http://www.mozilla.org/MPL/>

Software distributed under the License is distributed on an "AS IS" basis, WITHOUT WARRANTY OF ANY KIND, either express or implied. See the License for the specific language governing rights and limitations under the License.

The Original Code is \_\_\_\_\_.  
 The Initial Developer of the Original Code is \_\_\_\_\_.  
 Portions created by \_\_\_\_\_ are Copyright (C) \_\_\_\_\_  
 \_\_\_\_\_ .All Rights Reserved.  
 Contributor(s): \_\_\_\_\_.

Alternatively, the contents of this file may be used under the terms of the \_\_\_\_\_ license (the [ ] License), in which case the provisions of [ ] License are applicable instead of those above.If you wish to allow use of your version of this file only under the terms of the [ ] License and not to allow others to use your version of this file under the MPL, indicate your decision by deleting the provisions above and replace them with the notice and other provisions required by the [ ] License. If you do not delete the provisions above, a recipient may use your version of this file under either the MPL or the [ ] License."

[NOTE: The text of this Exhibit A may differ slightly from the text of the notices in the Source Code files of the Original Code. You should use the text of this Exhibit A rather than the text found in the Original Code Source Code for Your Modifications.]

## OpenSSL License

Copyright (c) 1998-2008 The OpenSSL Project. All rights reserved.

Redistribution and use in source and binary forms, with or without modification, are permitted provided that the following conditions are met:

1. Redistributions of source code must retain the above copyright notice, this list of conditions and the following disclaimer.
2. Redistributions in binary form must reproduce the above copyright notice, this list of conditions and the following disclaimer in the documentation and/or other materials provided with the distribution.
3. All advertising materials mentioning features or use of this software must display the following acknowledgment: "This product includes software developed by the OpenSSL Project for use in the OpenSSL Toolkit. (<http://www.openssl.org/>)"
4. The names "OpenSSL Toolkit" and "OpenSSL Project" must not be used to endorse or promote products derived from this software without prior written permission. For written permission, please contact [openssl-core@openssl.org](mailto:openssl-core@openssl.org).
5. Products derived from this software may not be called "OpenSSL" nor may "OpenSSL" appear in their names without prior written permission of the OpenSSL Project.
6. Redistributions of any form whatsoever must retain the following acknowledgment: "This product includes software developed by the OpenSSL Project for use in the OpenSSL Toolkit (<http://www.openssl.org/>)"

THIS SOFTWARE IS PROVIDED BY THE OpenSSL PROJECT ``AS IS'' AND ANY EXPRESSED OR IMPLIED WARRANTIES, INCLUDING, BUT NOT LIMITED TO, THE IMPLIED WARRANTIES OF MERCHANTABILITY AND FITNESS FOR A PARTICULAR PURPOSE ARE DISCLAIMED. IN NO EVENT SHALL THE OpenSSL PROJECT OR ITS CONTRIBUTORS BE LIABLE FOR ANY DIRECT, INDIRECT, INCIDENTAL, SPECIAL, EXEMPLARY, OR CONSEQUENTIAL DAMAGES (INCLUDING, BUT NOT LIMITED TO, PROCUREMENT OF SUBSTITUTE GOODS OR SERVICES; LOSS OF USE, DATA, OR PROFITS; OR BUSINESS INTERRUPTION) HOWEVER CAUSED AND ON ANY THEORY OF LIABILITY, WHETHER IN CONTRACT, STRICT LIABILITY, OR TORT (INCLUDING NEGLIGENCE OR OTHERWISE) ARISING IN ANY WAY OUT OF THE USE OF THIS SOFTWARE, EVEN IF ADVISED OF THE POSSIBILITY OF SUCH DAMAGE.

This product includes cryptographic software written by Eric Young ([eay@cryptsoft.com](mailto:eay@cryptsoft.com)).  
This product includes software written by Tim Hudson ([tjh@cryptsoft.com](mailto:tjh@cryptsoft.com)).

## Original SSLeay License

Copyright (C) 1995-1998 Eric Young ([eay@cryptsoft.com](mailto:eay@cryptsoft.com)) All rights reserved.

This package is an SSL implementation written by Eric Young ([eay@cryptsoft.com](mailto:eay@cryptsoft.com)).  
The implementation was written so as to conform with Netscapes SSL.

This library is free for commercial and non-commercial use as long as the following conditions are adhered to. The following conditions apply to all code found in this distribution, be it the RC4, RSA, lhash, DES, etc., code; not just the SSL code. The SSL documentation included with this distribution is covered by the same copyright terms except that the holder is Tim Hudson ([tjh@cryptsoft.com](mailto:tjh@cryptsoft.com)).

Copyright remains Eric Young's, and as such any Copyright notices in the code are not to be removed. If this package is used in a product, Eric Young should be given attribution as the author of the parts of the library used. This can be in the form of a textual message at program startup or in documentation (online or textual) provided with the package. Redistribution and use in source and binary forms, with or without modification, are permitted provided that the following conditions are met:

1. Redistributions of source code must retain the copyright notice, this list of conditions and the following disclaimer.
2. Redistributions in binary form must reproduce the above copyright notice, this list of conditions and the following disclaimer in the documentation and/or other materials provided with the distribution.

3. All advertising materials mentioning features or use of this software must display the following acknowledgement:

"This product includes cryptographic software written by Eric Young (eay@cryptsoft.com)"

The word 'cryptographic' can be left out if the routines from the library being used are not cryptographic related :-).

4. If you include any Windows specific code (or a derivative thereof) from the apps directory (application code) you must include an acknowledgement:

"This product includes software written by Tim Hudson (tjh@cryptsoft.com)"

THIS SOFTWARE IS PROVIDED BY ERIC YOUNG "AS IS" AND ANY EXPRESS OR IMPLIED WARRANTIES, INCLUDING, BUT NOT LIMITED TO, THE IMPLIED WARRANTIES OF MERCHANTABILITY AND FITNESS FOR A PARTICULAR PURPOSE ARE DISCLAIMED. IN NO EVENT SHALL THE AUTHOR OR CONTRIBUTORS BE LIABLE FOR ANY DIRECT, INDIRECT, INCIDENTAL, SPECIAL, EXEMPLARY, OR CONSEQUENTIAL DAMAGES (INCLUDING, BUT NOT LIMITED TO, PROCUREMENT OF SUBSTITUTE GOODS OR SERVICES; LOSS OF USE, DATA, OR PROFITS; OR BUSINESS INTERRUPTION) HOWEVER CAUSED AND ON ANY THEORY OF LIABILITY, WHETHER IN CONTRACT, STRICT LIABILITY, OR TORT (INCLUDING NEGLIGENCE OR OTHERWISE) ARISING IN ANY WAY OUT OF THE USE OF THIS SOFTWARE, EVEN IF ADVISED OF THE POSSIBILITY OF SUCH DAMAGE.

The licence and distribution terms for any publically available version or derivative of this code cannot be changed. i.e. this code cannot simply be copied and put under another distribution licence [including the GNU Public Licence.]

## MIT license

### - libcurl

Copyright (c) 1996 - 2010, Daniel Stenberg, <daniel@haxx.se>.

All rights reserved.

Permission to use, copy, modify, and distribute this software for any purpose with or without fee is hereby granted, provided that the above copyright notice and this permission notice appear in all copies.

THE SOFTWARE IS PROVIDED "AS IS", WITHOUT WARRANTY OF ANY KIND, EXPRESS OR IMPLIED, INCLUDING BUT NOT LIMITED TO THE WARRANTIES OF MERCHANTABILITY, FITNESS FOR A PARTICULAR PURPOSE AND NONINFRINGEMENT OF THIRD PARTY RIGHTS. IN NO EVENT SHALL THE AUTHORS OR COPYRIGHT HOLDERS BE LIABLE FOR ANY CLAIM, DAMAGES OR OTHER LIABILITY, WHETHER IN AN ACTION OF CONTRACT, TORT OR OTHERWISE, ARISING FROM, OUT OF OR IN CONNECTION WITH THE SOFTWARE OR THE USE OR OTHER DEALINGS IN THE SOFTWARE.

Except as contained in this notice, the name of a copyright holder shall not be used in advertising or otherwise to promote the sale, use or other dealings in this Software without prior written authorization of the copyright holder.

### - ncurses

Copyright (c) 1998 Free Software Foundation, Inc.

Permission is hereby granted, free of charge, to any person obtaining a copy of this software and associated documentation files (the "Software"), to deal in the Software without restriction, including without limitation the rights to use, copy, modify, merge, publish, distribute, distribute with modifications, sublicense, and/or sell copies of the Software, and to permit persons to whom the Software is furnished to do so, subject to the following conditions:

The above copyright notice and this permission notice shall be included in all copies or substantial portions of the Software.

THE SOFTWARE IS PROVIDED "AS IS", WITHOUT WARRANTY OF ANY KIND, EXPRESS OR IMPLIED, INCLUDING BUT NOT LIMITED TO THE WARRANTIES OF MERCHANTABILITY, FITNESS FOR A PARTICULAR PURPOSE AND NONINFRINGEMENT. IN NO EVENT SHALL THE ABOVE COPYRIGHT HOLDERS BE LIABLE FOR ANY CLAIM, DAMAGES OR OTHER LIABILITY, WHETHER IN AN ACTION OF CONTRACT, TORT OR OTHERWISE, ARISING FROM, OUT OF OR IN CONNECTION WITH THE SOFTWARE OR THE USE OR OTHER DEALINGS IN THE

SOFTWARE.

Except as contained in this notice, the name(s) of the above copyright holders shall not be used in advertising or otherwise to promote the sale, use or other dealings in this Software without prior written authorization.

## Expat license

The source package was downloaded from <URL:http://expat.sourceforge.net>.

The original packager is Adam Di Carlo <aph@debian.org>.

The current maintainer is Ardo van Rangelrooij <ardo@debian.org>.

Copyright (c) 1998, 1999, 2000 Thai Open Source Software Center Ltd and Clark Cooper

Copyright (c) 2001, 2002, 2003, 2004, 2005, 2006 Expat maintainers.

Permission is hereby granted, free of charge, to any person obtaining a copy of this software and associated documentation files (the "Software"), to deal in the Software without restriction, including without limitation the rights to use, copy, modify, merge, publish, distribute, sublicense, and/or sell copies of the Software, and to permit persons to whom the Software is furnished to do so, subject to the following conditions:

The above copyright notice and this permission notice shall be included in all copies or substantial portions of the Software.

THE SOFTWARE IS PROVIDED "AS IS", WITHOUT WARRANTY OF ANY KIND, EXPRESS OR IMPLIED, INCLUDING BUT NOT LIMITED TO THE WARRANTIES OF MERCHANTABILITY, FITNESS FOR A PARTICULAR PURPOSE AND NONINFRINGEMENT. IN NO EVENT SHALL THE AUTHORS OR COPYRIGHT HOLDERS BE LIABLE FOR ANY CLAIM, DAMAGES OR OTHER LIABILITY, WHETHER IN AN ACTION OF CONTRACT, TORT OR OTHERWISE, ARISING FROM, OUT OF OR IN CONNECTION WITH THE SOFTWARE OR THE USE OR OTHER DEALINGS IN THE SOFTWARE.

## The FreeType Project LICENSE

Copyright 1996-2002, 2006 by David Turner, Robert Wilhelm, and Werner Lemberg

### Introduction

=====

The FreeType Project is distributed in several archive packages; some of them may contain, in addition to the FreeType font engine, various tools and contributions which rely on, or relate to, the FreeType Project.

This license applies to all files found in such packages, and which do not fall under their own explicit license. The license affects thus the FreeType font engine, the test programs, documentation and makefiles, at the very least.

This license was inspired by the BSD, Artistic, and IJG (Independent JPEG Group) licenses, which all encourage inclusion and use of free software in commercial and freeware products alike. As a consequence, its main points are that:

- We don't promise that this software works. However, we will be interested in any kind of bug reports. ('as is' distribution)
- You can use this software for whatever you want, in parts or full form, without having to pay us. ('royalty-free' usage)
- You may not pretend that you wrote this software. If you use it, or only parts of it, in a program, you must acknowledge somewhere in your documentation that you have used the FreeType code. ('credits')

We specifically permit and encourage the inclusion of this software, with or without modifications, in commercial products. We disclaim all warranties covering The FreeType Project and assume no liability related to The FreeType Project.

Finally, many people asked us for a preferred form for a credit/disclaimer to use in compliance with this license. We

thus encourage you to use the following text:

Portions of this software are copyright <year> The FreeType Project (www.freetype.org). All rights reserved.  
Please replace <year> with the value from the FreeType version you actually use.

## Legal Terms

### 0. Definitions

Throughout this license, the terms 'package', 'FreeType Project' and 'FreeType archive' refer to the set of files originally distributed by the authors (David Turner, Robert Wilhelm, and Werner Lemberg) as the 'FreeType Project', be they named as alpha, beta or final release.

'You' refers to the licensee, or person using the project, where 'using' is a generic term including compiling the project's source code as well as linking it to form a 'program' or 'executable'. This program is referred to as 'a program using the FreeType engine'.

This license applies to all files distributed in the original FreeType Project, including all source code, binaries and documentation, unless otherwise stated in the file in its original, unmodified form as distributed in the original archive. If you are unsure whether or not a particular file is covered by this license, you must contact us to verify this.

The FreeType Project is copyright (C) 1996-2000 by David Turner, Robert Wilhelm, and Werner Lemberg. All rights reserved except as specified below.

### 1. No Warranty

THE FREETYPE PROJECT IS PROVIDED 'AS IS' WITHOUT WARRANTY OF ANY KIND, EITHER EXPRESS OR IMPLIED, INCLUDING, BUT NOT LIMITED TO, WARRANTIES OF MERCHANTABILITY AND FITNESS FOR A PARTICULAR PURPOSE. IN NO EVENT WILL ANY OF THE AUTHORS OR COPYRIGHT HOLDERS BE LIABLE FOR ANY DAMAGES CAUSED BY THE USE OR THE INABILITY TO USE, OF THE FREETYPE PROJECT.

### 2. Redistribution

This license grants a worldwide, royalty-free, perpetual and irrevocable right and license to use, execute, perform, compile, display, copy, create derivative works of, distribute and sublicense the FreeType Project (in both source and object code forms) and derivative works thereof for any purpose; and to authorize others to exercise some or all of the rights granted herein, subject to the following conditions:

- Redistribution of source code must retain this license file ('FTL.TXT') unaltered; any additions, deletions or changes to the original files must be clearly indicated in accompanying documentation. The copyright notices of the unaltered, original files must be preserved in all copies of source files.
- Redistribution in binary form must provide a disclaimer that states that the software is based in part of the work of the FreeType Team, in the distribution documentation. We also encourage you to put an URL to the FreeType web page in your documentation, though this isn't mandatory.

These conditions apply to any software derived from or based on the FreeType Project, not just the unmodified files. If you use our work, you must acknowledge us. However, no fee need be paid to us.

### 3. Advertising

Neither the FreeType authors and contributors nor you shall use the name of the other for commercial, advertising, or promotional purposes without specific prior written permission. We suggest, but do not require, that you use one or more of the following phrases to refer to this software in your documentation or advertising materials: 'FreeType Project', 'FreeType Engine', 'FreeType library', or 'FreeType Distribution'.

As you have not signed this license, you are not required to accept it. However, as the FreeType Project is copyrighted material, only this license, or another one contracted with the authors, grants you the right to use, distribute, and modify it. Therefore, by using, distributing, or modifying the FreeType Project, you indicate that you understand and accept all the terms of this license.

### 4. Contacts

There are two mailing lists related to FreeType:

freetype@nongnu.org

Discusses general use and applications of FreeType, as well as future and wanted additions to the library and distribution. If you are looking for support, start in this list if you haven't found anything to help you in the documentation.

freetype-devel@nongnu.org

Discusses bugs, as well as engine internals, design issues, specific licenses, porting, etc.  
Our home page can be found at <http://www.freetype.org>

## JPEG license

This software is copyright (C) 1991-1998, Thomas G. Lane.  
All Rights Reserved except as specified below.

Permission is hereby granted to use, copy, modify, and distribute this software (or portions thereof) for any purpose, without fee, subject to these conditions:

- (1) If any part of the source code for this software is distributed, then this README file must be included, with this copyright and no-warranty notice unaltered; and any additions, deletions, or changes to the original files must be clearly indicated in accompanying documentation.
- (2) If only executable code is distributed, then the accompanying documentation must state that "this software is based in part on the work of the Independent JPEG Group".
- (3) Permission for use of this software is granted only if the user accepts full responsibility for any undesirable consequences; the authors accept NO LIABILITY for damages of any kind.

## zlib/libpng License

This product may contain open source software licensed under **zlib/libpng License**.

- **Libmng : Copyright © 2000-2008 Gerard Juyn ([gerard@libmng.com](mailto:gerard@libmng.com))**
- **Libpng : Copyright (c) 1998-2008 Glenn Randers-Pehrson**  
(Version 0.96 Copyright (c) 1996, 1997 Andreas Dilger)  
(Version 0.88 Copyright (c) 1995, 1996 Guy Eric Schalnat, Group 42, Inc.)
- **Md5 checksum : Copyright (C) 1999, 2000, 2002 Aladdin Enterprises.**
- **Zlib : Copyright (C) 1995-2010 Jean-loup Gailly and Mark Adler**

This software is provided 'as-is', without any express or implied warranty. In no event will the authors be held liable for any damages arising from the use of this software.

Permission is granted to anyone to use this software for any purpose, including commercial applications, and to alter it and redistribute it freely, subject to the following restrictions:

1. The origin of this software must not be misrepresented; you must not claim that you wrote the original software. If you use this software in a product, an acknowledgment in the product documentation would be appreciated but is not required.
2. Altered source versions must be plainly marked as such, and must not be misrepresented as being the original software.
3. This notice may not be removed or altered from any source distribution.

Jean-loup Gailly  
Mark Adler

## X.net license

Copyright (c) 1995-2001 International Business Machines Corporation and others  
All rights reserved.

Permission is hereby granted, free of charge, to any person obtaining a copy of this software and associated documen-

tation files (the “Software”), to deal in the Software without restriction, including without limitation the rights to use, copy, modify, merge, publish, distribute, and/or sell copies of the Software, and to permit persons to whom the Software is furnished to do so, provided that the above copyright notice(s) and this permission notice appear in all copies of the Software and that both the above copyright notice(s) and this permission notice appear in supporting documentation.

THE SOFTWARE IS PROVIDED “AS IS”, WITHOUT WARRANTY OF ANY KIND, EXPRESS OR IMPLIED, INCLUDING BUT NOT LIMITED TO THE WARRANTIES OF MERCHANTABILITY, FITNESS FOR A PARTICULAR PURPOSE AND NONINFRINGEMENT OF THIRD PARTY RIGHTS. IN NO EVENT SHALL THE COPYRIGHT HOLDER OR HOLDERS INCLUDED IN THIS NOTICE BE LIABLE FOR ANY CLAIM, OR ANY SPECIAL INDIRECT OR CONSEQUENTIAL DAMAGES, OR ANY DAMAGES WHATSOEVER RESULTING FROM LOSS OF USE, DATA OR PROFITS, WHETHER IN AN ACTION OF CONTRACT, NEGLIGENCE OR OTHER TORTIOUS ACTION, ARISING OUT OF OR IN CONNECTION WITH THE USE OR PERFORMANCE OF THIS SOFTWARE.

Except as contained in this notice, the name of a copyright holder shall not be used in advertising or otherwise to promote the sale, use or other dealings in this Software without prior written authorization of the copyright holder.

## BSD license

### - strace

Copyright (c) 1991, 1992 Paul Kranenburg <pk@cs.few.eur.nl>  
 Copyright (c) 1993 Branko Lankester <branko@hacktic.nl>  
 Copyright (c) 1993 Ulrich Pegelow <pegelow@moorea.uni-muenster.de>  
 Copyright (c) 1995, 1996 Michael Elizabeth Chastain <mec@duracef.shout.net>  
 Copyright (c) 1993, 1994, 1995, 1996 Rick Sladkey <jrs@world.std.com>  
 Copyright (C) 1998-2003 Wichert Akkerman <wakkerma@deephackmode.org>  
 Copyright (c) 2002-2008 Roland McGrath <roland@redhat.com>  
 Copyright (c) 2003-2008 Dmitry V. Levin <ldv@altlinux.org>  
 Copyright (c) 2007-2008 Jan Kratochvil <jan.kratochvil@redhat.com>  
 All rights reserved.

Redistribution and use in source and binary forms, with or without modification, are permitted provided that the following conditions are met:

1. Redistributions of source code must retain the above copyright notice, this list of conditions and the following disclaimer.
2. Redistributions in binary form must reproduce the above copyright notice, this list of conditions and the following disclaimer in the documentation and/or other materials provided with the distribution.
3. Neither the names of PolarSSL or XySSL nor the names of its contributors may be used to endorse or promote products derived from this software without specific prior written permission.

THIS SOFTWARE IS PROVIDED BY THE COPYRIGHT HOLDERS AND CONTRIBUTORS “AS IS” AND ANY EXPRESS OR IMPLIED WARRANTIES, INCLUDING, BUT NOT LIMITED TO, THE IMPLIED WARRANTIES OF MERCHANTABILITY AND FITNESS FOR A PARTICULAR PURPOSE ARE DISCLAIMED. IN NO EVENT SHALL THE COPYRIGHT OWNER OR CONTRIBUTORS BE LIABLE FOR ANY DIRECT, INDIRECT, INCIDENTAL, SPECIAL, EXEMPLARY, OR CONSEQUENTIAL DAMAGES (INCLUDING, BUT NOT LIMITED TO, PROCUREMENT OF SUBSTITUTE GOODS OR SERVICES; LOSS OF USE, DATA, OR PROFITS; OR BUSINESS INTERRUPTION) HOWEVER CAUSED AND ON ANY THEORY OF LIABILITY, WHETHER IN CONTRACT, STRICT LIABILITY, OR TORT (INCLUDING NEGLIGENCE OR OTHERWISE) ARISING IN ANY WAY OUT OF THE USE OF THIS SOFTWARE, EVEN IF ADVISED OF THE POSSIBILITY OF SUCH DAMAGE.

### - xyssl

Copyright (C) 2006-2008 Christophe Devine  
 Copyright (C) 2009 Paul Bakker <polarssl\_maintainer at polarssl dot org>  
 All rights reserved.

Redistribution and use in source and binary forms, with or without modification, are permitted provided that the following conditions are met:

1. Redistributions of source code must retain the above copyright notice, this list of conditions and the following disclaimer.
2. Redistributions in binary form must reproduce the above copyright notice, this list of conditions and the following disclaimer in the documentation and/or other materials provided with the distribution.
3. Neither the names of PolarSSL or XySSL nor the names of its contributors may be used to endorse or promote products derived from this software without specific prior written permission.

THIS SOFTWARE IS PROVIDED BY THE COPYRIGHT HOLDERS AND CONTRIBUTORS "AS IS" AND ANY EXPRESS OR IMPLIED WARRANTIES, INCLUDING, BUT NOT LIMITED TO, THE IMPLIED WARRANTIES OF MERCHANTABILITY AND FITNESS FOR A PARTICULAR PURPOSE ARE DISCLAIMED. IN NO EVENT SHALL THE COPYRIGHT OWNER OR CONTRIBUTORS BE LIABLE FOR ANY DIRECT, INDIRECT, INCIDENTAL, SPECIAL, EXEMPLARY, OR CONSEQUENTIAL DAMAGES (INCLUDING, BUT NOT LIMITED TO, PROCUREMENT OF SUBSTITUTE GOODS OR SERVICES; LOSS OF USE, DATA, OR PROFITS; OR BUSINESS INTERRUPTION) HOWEVER CAUSED AND ON ANY THEORY OF LIABILITY, WHETHER IN CONTRACT, STRICT LIABILITY, OR TORT (INCLUDING NEGLIGENCE OR OTHERWISE) ARISING IN ANY WAY OUT OF THE USE OF THIS SOFTWARE, EVEN IF ADVISED OF THE POSSIBILITY OF SUCH DAMAGE.

### **RSA Data Security license**

Copyright (C) 1991-2, RSA Data Security, Inc. Created 1991. All rights reserved.

License to copy and use this software is granted provided that it is identified as the "RSA Data Security, Inc. MD5 Message-Digest Algorithm" in all material mentioning or referencing this software or this function.

License is also granted to make and use derivative works provided that such works are identified as "derived from the RSA Data Security, Inc. MD5 Message-Digest Algorithm" in all material mentioning or referencing the derived work.

RSA Data Security, Inc. makes no representations concerning either the merchantability of this software or the suitability of this software for any particular purpose. It is provided "as is" without express or implied warranty of any kind. These notices must be retained in any copies of any part of this documentation and/or software.





The model and serial numbers of the TV is located on the back of the TV  
Record it below should you ever need service.

MODEL \_\_\_\_\_

SERIAL \_\_\_\_\_



Trade Mark of the DVB Digital Video Broadcasting Project (1991 to 1996)