

## INSTALLATION MANUAL

# AIR CONDITIONER

Please read this installation manual completely before installing the product. Installation work must be performed in accordance with the national wiring standards by authorized personnel only. Please retain this installation manual for future reference after reading it thoroughly.

**MULTI V™** (Heat Recovery Unit)  
PRHR042A/PRHR032A/PRHR022A



P/NO : MFL32987309

<http://www.lghvac.com>  
[www.lg.com](http://www.lg.com)

Copyright © 2014 - 2018 LG Electronics Inc. All Rights Reserved.

## TIPS FOR SAVING ENERGY

Here are some tips that will help you minimize the power consumption when you use the air conditioner. You can use your air conditioner more efficiently by referring to the instructions below:

- Do not cool excessively indoors. This may be harmful for your health and may consume more electricity.
- Block sunlight with blinds or curtains while you are operating the air conditioner.
- Keep doors or windows closed tightly while you are operating the air conditioner.
- Adjust the direction of the air flow vertically or horizontally to circulate indoor air.
- Speed up the fan to cool or warm indoor air quickly, in a short period of time.
- Open windows regularly for ventilation as the indoor air quality may deteriorate if the air conditioner is used for many hours.
- Clean the air filter once every 2 weeks. Dust and impurities collected in the air filter may block the air flow or weaken the cooling / dehumidifying functions.

### *For your records*

Staple your receipt to this page in case you need it to prove the date of purchase or for warranty purposes. Write the model number and the serial number here:

Model number : \_\_\_\_\_

Serial number : \_\_\_\_\_

You can find them on a label on the side of each unit.

Dealer's name : \_\_\_\_\_

Date of purchase : \_\_\_\_\_

## IMPORTANT!

Please read this instruction sheet completely before installing the product.

This air conditioning system meets strict safety and operating standards. As the installer or service person, it is an important part of your job to install or service the system so it operates safely and efficiently.

### ⚠ WARNING

- Installation or repairs made by unqualified persons can result in hazards to you and others. Installation of all field wiring and components **MUST** conform with local building codes or, in the absence of local codes, with the National Electrical Code 70 and the National Building Construction and Safety Code or Canadian Electrical code and National Building Code of Canada.
- The information contained in the manual is intended for use by a qualified service technician familiar with safety procedures and equipped with the proper tools and test instruments.
- Failure to carefully read and follow all instructions in this manual can result in equipment malfunction, property damage, personal injury and/or death.

**CAUTION:** Improper installation, adjustment, alteration, service or maintenance can void the warranty.

The weight of the condensing unit requires caution and proper handling procedures when lifting or moving to avoid personal injury. Use care to avoid contact with sharp or pointed edges.

#### Safety Precautions

- Always wear safety eye wear and work gloves when installing equipment.
- Never assume electrical power is disconnected. Check with meter and equipment.
- Keep hands out of fan areas when power is connected to equipment.
- R-410A causes frostbite burns.
- R-410A is toxic when burned.

**NOTE TO INSTALLING DEALER** : The Owners Instructions and Warranty are to be given to the owner or prominently displayed near the indoor Furnace/Air Handler Unit.

### ⚠ WARNING

#### When wiring:

**Electrical shock can cause severe personal injury or death. Only a qualified, experienced electrician should attempt to wire this system.**

- Do not supply power to the unit until all wiring and tubing are completed or reconnected and checked.
- Highly dangerous electrical voltages are used in this system. Carefully refer to the wiring diagram and these instructions when wiring. Improper connections and inadequate grounding can cause accidental injury or death.
- Ground the unit following local electrical codes.
- Connect all wiring tightly. Loose wiring may cause overheating at connection points and a possible fire hazard.
- The choice of materials and installations must comply with the applicable local/national or international standards.

#### When transporting:

Be careful when picking up and moving the indoor and outdoor units. Get a partner to help, and bend your knees when lifting to reduce strain on your back. Sharp edges or thin aluminum fins on the air conditioner can cut your finger.

#### When installing...

- ... in a **wall**: Make sure the wall is strong enough to hold the unit's weight. It may be necessary to construct a strong wood or metal frame to provide added support.
- ... in a **room** : Properly insulate any tubing run inside a room to prevent "sweating" that can cause dripping and water damage to wall and floors.
- ... in **moist or uneven locations**: Use a raised concrete pad or concrete blocks provide a solid, level foundation for the outdoor unit. This prevents water damage and abnormal vibration.
- ... in an **area with high winds**: Securely anchor the outdoor unit down with bolts and a metal frame. Provide a suitable air baffle.
- ... in a **snow y area(for Heat Pump Model)**: Install the outdoor unit on a raised platform that is higher than drifting snow. Provide snow vents.

#### When connecting refrigerant tubing

- Keep all tubing runs as short as possible.
- Use the flare method for connecting tubing.
- Check carefully for leaks before starting the test run.

#### When servicing

- Turn the power **OFF** at the main power box(mains) before opening the unit to check or repair electrical parts and wiring.
- Keep your fingers and clothing away from any moving parts.
- Clean up the site after you finish, remembering to check that no metal scraps or bits of wiring have been left inside the unit being serviced.

# IMPORTANT SAFETY INSTRUCTIONS

## **READ ALL INSTRUCTIONS BEFORE USING THE APPLIANCE.**

Always comply with the following precautions to avoid dangerous situations and ensure peak performance of your product

### **WARNING**

It can result in serious injury or death when the directions are ignored

### **CAUTION**

It can result in minor injury or product damage when the directions are ignored

### **WARNING**

- Installation or repairs made by unqualified persons can result in hazards to you and others.
- The information contained in the manual is intended for use by a qualified service technician familiar with safety procedures and equipped with the proper tools and test instruments.
- Failure to carefully read and follow all instructions in this manual can result in equipment malfunction, property damage, personal injury and/or death.

### **WARNING**

- Have all electric work done by a licensed electrician according to "Electric Facility Engineering Standard" and "Interior Wire Regulations" and the instructions given in this manual and always use a special circuit.
  - If the power source capacity is inadequate or electric work is performed improperly, electric shock or fire may result.
- Ask the dealer or an authorized technician to install the HR unit.
  - Improper installation by the user may result in water leakage, electric shock, or fire.
- Always ground the product.
  - There is risk of fire or electric shock.
- Make the connections securely so that the outside force of the cable may not be applied to the terminals.
  - Inadequate connection and fastening may generate heat and cause a fire.
- For re-installation of the installed product, always contact a dealer or an Authorized Service Center.
  - There is risk of fire, electric shock, explosion, or injury.
- Do not install, remove, or re-install the unit by yourself (customer).
  - There is risk of fire, electric shock, explosion, or injury.
- Do not store or use flammable gas or combustibles near the HR Unit.
  - There is risk of fire or failure of product.
- Use the correctly rated breaker or fuse.
  - There is risk of fire or electric shock.
- Do not damage or use an unspecified power cord.
  - There is risk of fire, electric shock, explosion, or injury.

- Do not touch the power switch with wet hands.
  - There is risk of fire, electric shock, explosion, or injury.
- Securely install the cover of control box and the panel.
  - If the cover and panel are not installed securely, dust or water may enter the HR unit and fire or electric shock may result.
- Be cautious when unpacking and installing the product.
  - Sharp edges could cause injury. Be especially careful of the case edges.
- Safely dispose of the packing materials.
  - Packing materials, such as nails and other metal or wooden parts, may cause stabs or other injuries.
  - Tear apart and throw away plastic packaging bags so that children may not play with them. If children play with a plastic bag which was not torn apart, they face the risk of suffocation.

### CAUTION

- Avoid a place where rain may enter since the HR unit is for indoor.
  - There is risk of property damage, failure of product, or electric shock.
- Install the HR unit at a place in which it is not affected by operation mode changing noise.
  - Installation within cell such as meeting room etc. may disturb business due to noise.
- Always check for gas (refrigerant) leakage after installation or repair of product.
  - Low refrigerant levels may cause failure of product.
- Keep level even when installing the product.
  - To avoid vibration or water leakage.

# TABLE OF CONTENTS

## 2 TIPS FOR SAVING ENERGY

---

## 4 IMPORTANT SAFETY INSTRUCTIONS

---

## 7 FEATURES

---

## 8 INSTALLATION PART

---

## 9 INSTALLATION

---

9 Selection of the best location

9 Dimensional drawings

11 HR Unit Installation

13 Thermal Insulation

14 Wiring Connection

15 Setup the switch of HR Unit

## 20 COIL EXCHANGING METHOD

---

## 21 JOINT METHOD OF HR UNIT

---

# FEATURES

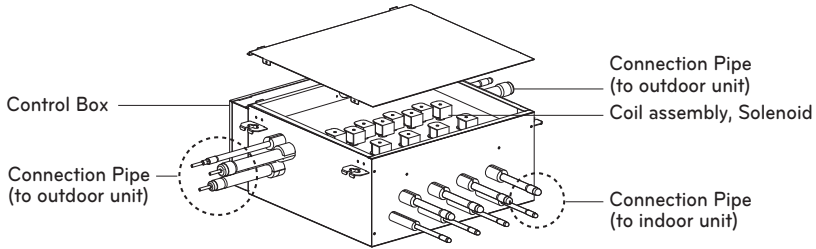





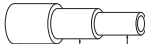

| Model  |                           | PRHR022A                               | PRHR032A                 | PRHR042A      |               |
|--|---------------------------|--|--------------------------|---------------|---------------|
| Max. Connectable No. of Indoor Units             |                           | 16                                     | 24                       | 32            |               |
| Max. Connectable No. of Indoor Units of a branch |                           | 8                                      | 8                        | 8             |               |
| Nominal Input                                    | Cooling                   | 26                                     | 40                       | 40            |               |
|  | Heating                   | 26                                     | 40                       | 40            |               |
| Net. Weight                                      | kg                        | 15.2                                   | 17.2                     | 19.2          |               |
|  | lbs                       | 33.5                                   | 37.9                     | 42.3          |               |
| Dimensions (WxHxD)                               | mm                        | 801x218x632                            | 801x218x632              | 801x218x632   |               |
|  | Inch                      | 31.5x8.6x24.9                          | 31.5x8.6x24.9            | 31.5x8.6x24.9 |               |
| Casing   |                           | Galvanized steel plate                 |                          |               |               |
| Connecting Pipes                                 | Indoor side               | Liquid Pipe [mm/inch]                  | Ø9.52[3/8] – Ø6.35[1/4]  |               |               |
|  |                           | Gas Pipe [mm/inch]                     | Ø15.88[5/8] – Ø12.7[1/2] |               |               |
|  | Outdoor side              | Liquid [mm/inch]                       | Ø9.52[3/8]               | Ø12.7[1/2]    | Ø15.88[5/8]   |
|  |                           | Low Pressure [mm/inch]                 | Ø22.2[7/8]               | Ø28.58[1-1/8] | Ø28.58[1-1/8] |
|  |                           | High Pressure [mm/inch]                | Ø19.05[3/4]              | Ø22.2[7/8]    | Ø22.2[7/8]    |
| Sound Absorbing Insulation Material              |                           | Polyethylene Foam                      |                          |               |               |
| Current  | Minimum circuit Amps(MCA) |  | 0.2                      |               |               |
|  | Maximum fuse Amps(MFA)    |  | 15                       |               |               |
| Power Supply                                     |                           | 1Ø, 220-240V,50 Hz / 1Ø, 208/230V,60Hz |                          |               |               |

# INSTALLATION PART

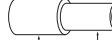
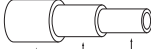
- Installation Manual
- Hanging bolts (4 x M10 or M8, Nut(8 x M10 or M8), Flat washers(8 x M10)
- Reducers

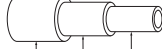
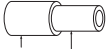
[Unit : mm(inch)]

| Models          |                       | Liquid pipe  | Gas pipe   |   |
|-----------------|-----------------------|--|--|---|
|                 |                       |  | High pressure  | Low pressure  |
| HR unit reducer | PRHR022A              | <br>OD9.52(3/8) Ø6.35(1/4)  | <br>OD19.05(3/4) Ø15.88(5/8) Ø12.7(1/2)<br><br>OD12.7(1/2) Ø9.52(3/8)  | <br>OD22.2(7/8) Ø19.05(3/4) Ø15.88(5/8)<br><br>OD15.88(5/8) Ø12.7(1/2)    |
|                 | PRHR032A/<br>PRHR042A | <br>OD15.88(5/8) Ø12.7(1/2) Ø9.52(3/8)<br><br>OD12.7(1/2) Ø9.52(3/8) | <br>OD22.2(7/8) Ø19.05(3/4) Ø15.88(5/8)<br><br>OD15.88(5/8) Ø12.7(1/2) | <br>OD28.58(1-1/8) Ø22.2(7/8) Ø19.05(3/4)<br><br>OD19.05(3/4) Ø15.88(5/8) |

# INSTALLATION

## Selection of the best location

Select installation location of the HR unit suitable for following conditions

- Avoid a place where rain may enter since the HR unit is for indoor.
- Sufficient service space must be obtained.
- Refrigerant pipe must not exceed limited length.
- Avoid a place subject to a strong radiation heat from other heat source.
- Avoid a place where oil spattering, vapor spray or high frequency electric noise is expected.
- Install the unit at a place in which it is not affected by operation noise. (Installation within cell such as meeting room etc. may disturb business due to noise.)
- Place where refrigerant piping, drain piping and electrical wiring works are easy.

## Dimensional drawings

[Unit : mm(inch)]

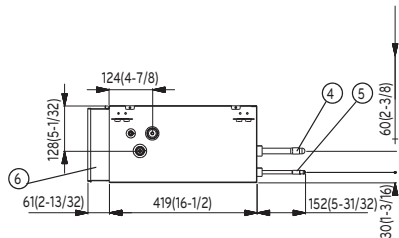
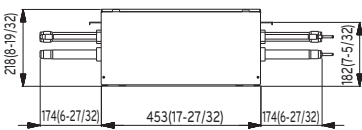
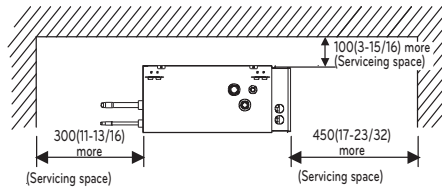
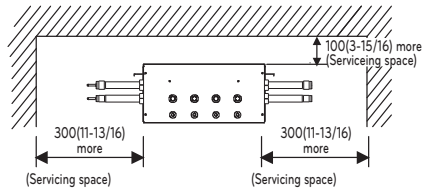
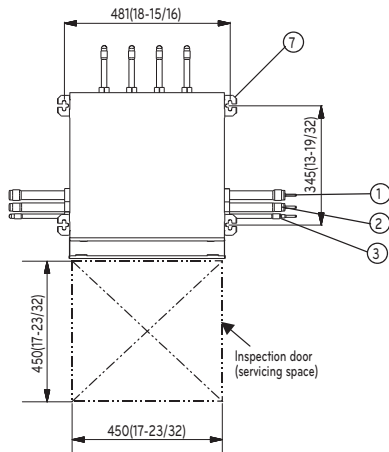

[Unit : mm(inch)]

| No. | Part Name                               | Description   |  |
|-----|---|---|--|
|     |   | PRHR032A/PRHR042A   | PRHR022A                                   |
| 1   | Low pressure Gas pipe connection port   | Ø28.58(1-1/8) Brazing connection  | Ø22.2(7/8) Brazing connection              |
| 2   | High pressure Gas pipe connection port  | Ø22.2(7/8) Brazing connection   | Ø19.05(3/4) Brazing connection             |
| 3   | Liquid pipe connection port             | Ø15.88(5/8) Brazing connection(PRHR042A)<br>Ø12.7(1/2) Brazing connection(PRHR032A) | Ø9.52(3/8) Brazing connection              |
| 4   | Indoor unit Gas pipe connection port    | Ø15.88(5/8)– Ø12.7(1/2) Brazing connection  | Ø15.88(5/8)– Ø12.7(1/2) Brazing connection |
| 5   | Indoor unit Liquid pipe connection port | Ø9.52(3/8)– Ø6.35(1/4) Brazing connection   | Ø9.52(3/8)– Ø6.35(1/4) Brazing connection  |
| 6   | Control box                             | -   | -  |
| 7   | Hanger metal                            | Suspension bolt M10 or M8   | Suspension bolt M10 or M8                  |

**! NOTE**

\* Be sure to install the inspection door at the electric control side.

\*\* If reducers are used, servicing space must be increased equal to reducer's dimension.

## HR Unit Installation

- Select and mark the position for fixing bolts.
- Drill the hole for set anchor on the face of ceiling.

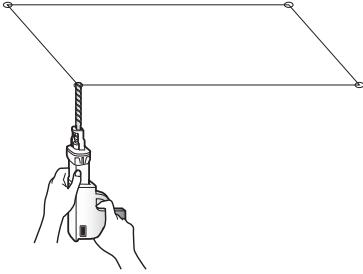

### CAUTION

Tighten the nut and bolt to prevent unit falling.

- Insert the set anchor and washer onto the suspension bolts for locking the suspension bolts on the ceiling.
- Mount the suspension bolts to the set anchor firmly.
- Secure the installation plates onto the suspension bolts (adjust level roughly) using nuts, washers and spring washers.

- 1 Using an insert-hole-in- anchor, hang the suspension bolt.
- 2 Install a hexagon nut and a flat washer (locally-procured)to the suspension bolt as shown in the figure in the bottom, and fit the main unit to hang on the hanger metal.
- 3 After checking with a level that the unit is level, tighten the hexagon nut.  
\* The tilt of the unit should be within  $\pm 5^\circ$  in front/back and left/right.
- 4 This unit should be installed suspended from ceiling and side A should always be facing up.

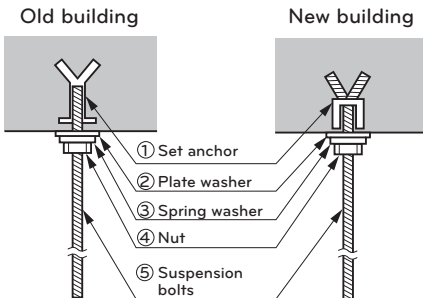
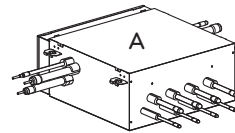
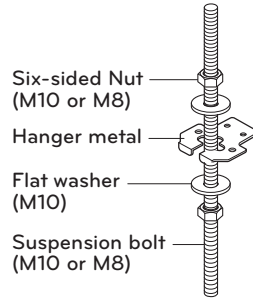

**CAUTION**

HR Unit should be installed that top side is facing up. If not, it may cause failure of the product.

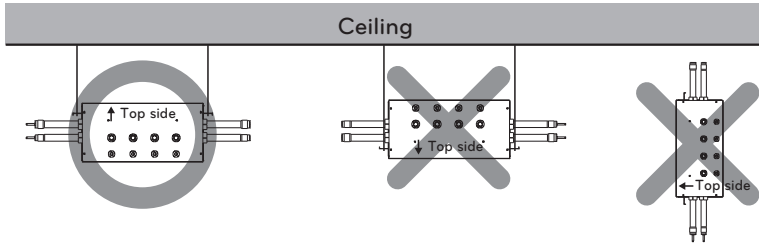

**WARNING**

Before brazing work, remove gas in the HR Unit by cutting the three pipes in the small circles on the figure. If not, it may cause injuries. Remove the caps before connecting pipes.

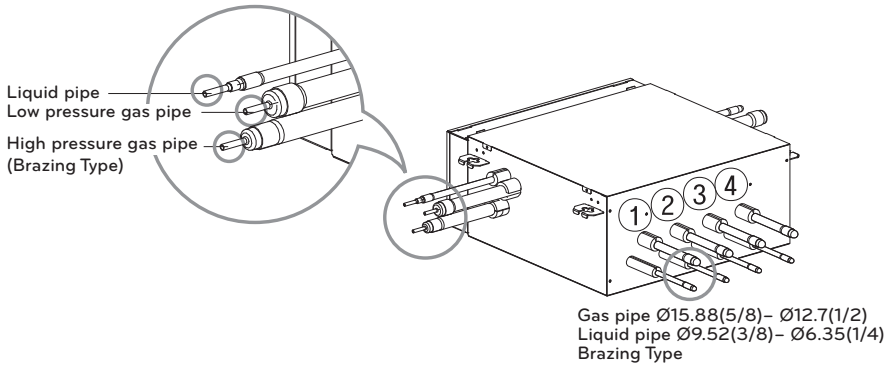

After considering the indoor unit capacity, determine the pipe sizes and cut the pipes connected to the indoor unit.



**CAUTION**

- Whenever connecting the indoor units with the HR unit, install the indoor units in numerical order from No.1.  
Ex) In case of installing 3 indoor units : No. 1, 2, 3 (O), No. 1, 2, 4 (X), No.1, 3, 4 (X), No.2, 3, 4 (X).
- Take care of no thermal damage on the valves of the HR unit.  
(Especially packing part of valve) Wrap the valve with a wet towel when brazing it.

## Insulation

Insulate the connected pipes completely(all thermal insulation must comply with local requirement)

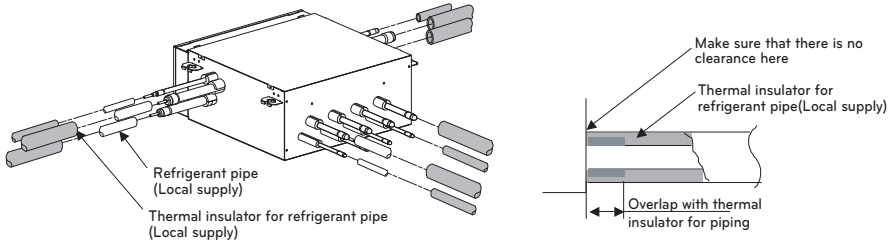

### ⚠ CAUTION

Insulate completely unconnected pipes as shown in the Figure.

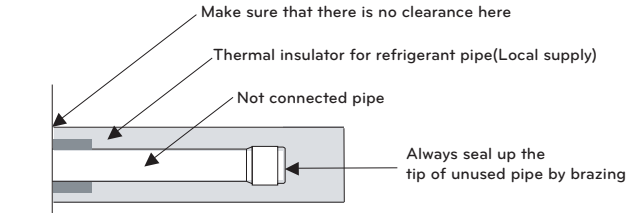

## Wiring Connection

Connect the wires to the terminals on the control board individually according to the outdoor unit connection.

- Ensure that the color of the wires of outdoor unit and the terminal No. are the same as those of HR Unit respectively.

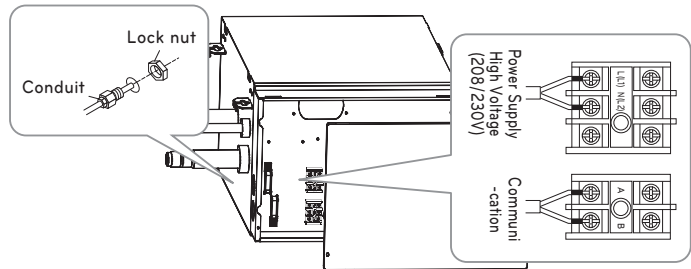
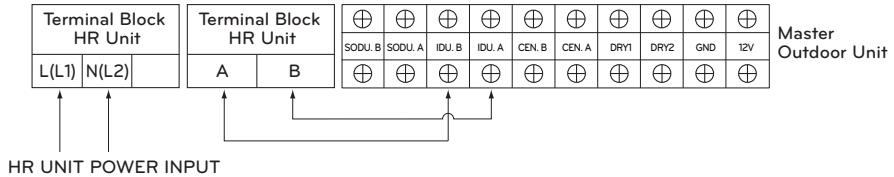

### ! WARNING

Loose wiring may cause the terminal to overheat or result in unit malfunction. A fire hazard may also exist. Therefore, be sure all wiring is tightly connected.

### ! WARNING

Make sure that the screws of the terminal are free from looseness.

## Setup the switch of HR Unit

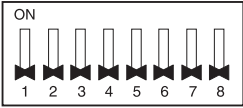

### Main function of SW02M

|  |   |                       |
|--|---|-----------------------|
|  <p style="text-align: center;">SW02M</p> |   |                       |
| ON S/W   | Selection   |                       |
| No.1   | Method for pipe detection of an HR unit (Auto/Manual) |                       |
| No.2   | Model of HR unit                                      |                       |
| No.3   | Model of HR unit                                      |                       |
| No.4   | Model of HR unit                                      |                       |
| No.5   | Valve group setting                                   |                       |
| No.6   | Valve group setting                                   |                       |
| No.7   | Use only in factory production (preset to "OFF")      | Zoning setting ("ON") |
| No.8   | Use only in factory production (preset to "OFF")      |                       |

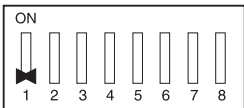
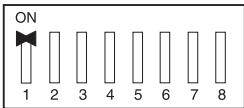



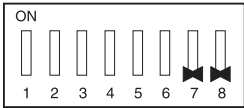
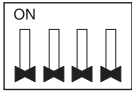

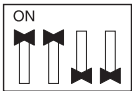
#### 1) Selection of the method for pipe detection of an HR unit (Auto/Manual)

| Auto  | Manual   |
|---|--|
| <p>Switch No.1 Off</p>  | <p>Switch No.1 On</p>  |

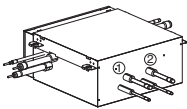
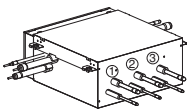
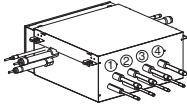
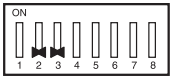
#### 2) Setting the zoning control

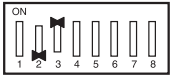
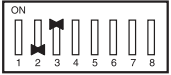
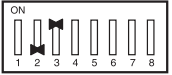
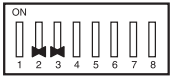
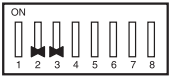
|                | DIP S/W setting   |   |
|----------------|---|---|
| Normal control |  |  <p style="text-align: center;">SW01M</p>  |
| Zoning control |  |  <p style="text-align: center;">SW01M</p> <p>Turn the dip switch of the zoning branch on.<br/>EX) Branch 1,2 are zoning control.</p> |

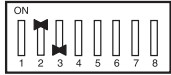
## 3) Selection of the model of the HR unit

|                      | <br>(For 2 branches)<br>PRHR022A | <br>(For 3 branches)<br>PRHR032A | <br>(For 4 branches)<br>PRHR042A |
|----------------------|---|---|---|
| Initial Setting      |                                  |                                  |                                  |
| 1 branch Connected   |                                  |                                  |                                  |
| 2 branches Connected |                                  |                                  |                                  |
| 3 branches Connected |   |                                  |                                  |
| 4 branches Connected |   |   |                                  |

\* Each model is shipped with the switches No.2 and No.3 pre-adjusted as above in the factory.

### ! WARNING

- If you want to use a PRHR032A for 2 branches HR unit after closing the 3rd pipes, set the dip switch for 2 branches HR unit.
- If you want to use a PRHR042A for 3 branches HR unit after closing the 4th pipes, set the dip switch for 3 branches HR unit.
- If you want to use a PRHR042A for 2 branches HR unit after closing the 3rd and 4th pipes, set the dip switch for 2 branches HR unit.
- The unused port must be closed with a copper cap, not with a plastic cap.

4) Setting the Valve Group

|                                       | DIP S/W setting | Example |
|---------------------------------------|-----------------|---------|
| Not control                           |                 |         |
| No.1, 2 Valve Control                 |                 |         |
| No.2, 3 Valve Control                 |                 |         |
| No.3, 4 Valve Control                 |                 |         |
| No.1, 2 Valve / No.3, 4 Valve Control |                 |         |

**NOTE**

If the large capacity indoor units are installed, below Y branch pipe should be used.

**\* Y branch pipe**

[Unit : mm(inch)]

| Models     | Low Pressure Gas Pipe | Liquid pipe | High Pressure Gas Pipe |
|------------|-----------------------|-------------|------------------------|
| ARBLB03321 |                       |             |                        |

## SW05M (Rotary S/W for addressing HR unit)

Must be set to '0' when installing only one HR unit.

When installing multiple HR units, address the HR units with sequentially increasing numbers starting from '0'.

Maximum 16 HR Units can be installed.

Ex) Installation of 3 HR units

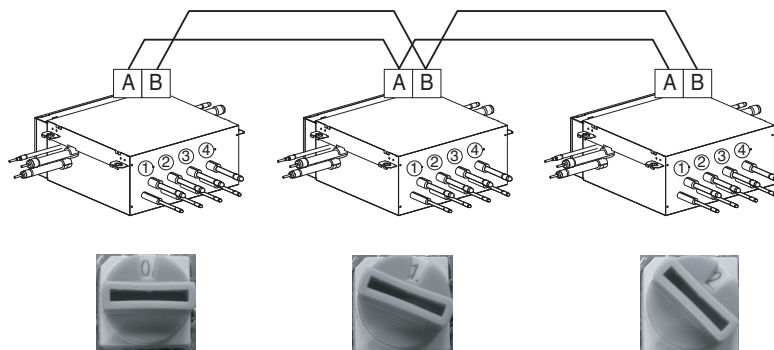



## SW01M/SW03M/SW04M

### (Dip S/W and tact S/W for manual valve addressing)



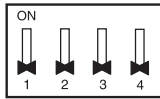

1) Normal setting (Non-Zoning setting)

- Set the address of the valve of the HR unit to the central control address of the connected indoor unit.
- SW01M: selection of the valve to address  
SW03M: increase in the digit of 10 of valve address  
SW04M: increase in the last digit of valve address
- Prerequisite for manual valve addressing : central control address of each indoor unit must be preset differently at its wired remote control.

| <br>SW01M | S/W No. | Setup  |
|--|---------|--|
|  | No.1    | Manual addressing of valve #1                |
|  | No.2    | Manual addressing of valve #2                |
|  | No.3    | Manual addressing of valve #3                |
|  | No.4    | Manual addressing of valve #4                |
| <br>SW03M | SW03M   | Increase in the digit of 10 of valve address |
| <br>SW04M | SW04M   | Increase in the last digit of valve address  |

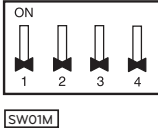
2) Zoning setting

- Set the address of the valve of the HR unit to the central control address of the connected indoor unit.
- SW01M : selection of the valve to address  
 SW03M : increase in the digit of 10 of valve address  
 SW04M : increase in the last digit of valve address  
 SW05M :Rotary S/W
- Prerequisite for manual valve addressing : central control address of each indoor unit must be preset differently at its wired remote control.

|   |         |  |
|---|---------|--|
|  | S/W No. | Setup  |
|   | No.1    | Manual addressing of valve #1                |
|   | No.2    | Manual addressing of valve #2                |
|   | No.3    | Manual addressing of valve #3                |
|   | No.4    | Manual addressing of valve #4                |
|  | SW03M   | Increase in the digit of 10 of valve address |
|  | SW04M   | Increase in the last digit of valve address  |
|  | SW05M   | Manual addressing of zoning indoor units     |

# COIL EXCHANGING METHOD

- 1 Remove the 2 securing screws.  
Remove the cover by pulling on the bottom of the cover and lifting up.

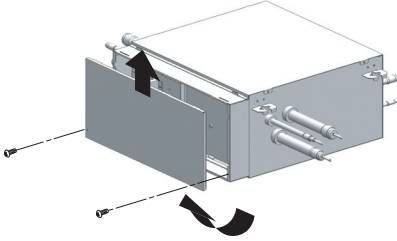

- 2 Take out the connectors on the pcb.  
Remove the 4 securing screws.  
Lay down the control box.

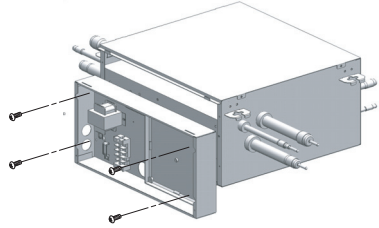

- 3 Remove the 4 securing screws.  
Lift up and pull on the cover.

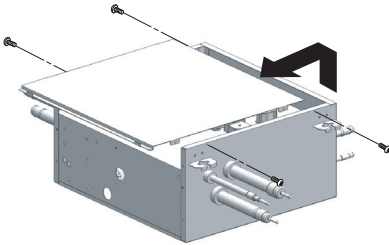

- 4 Remove the securing nut with a spanner.  
Exchange the coil.

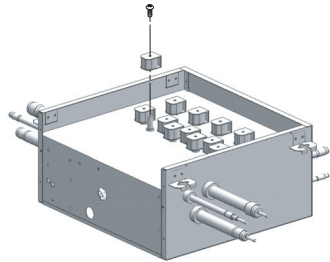

## NOTE

Refer to the label concerned the solenoid coil's position attached on the cover inside.

## NOTICE

Be sure that system power off before exchanging the coil.  
Check the position of the solenoid coil with the label attached on the cover inside when abnormal noise is heard loudly during operation.

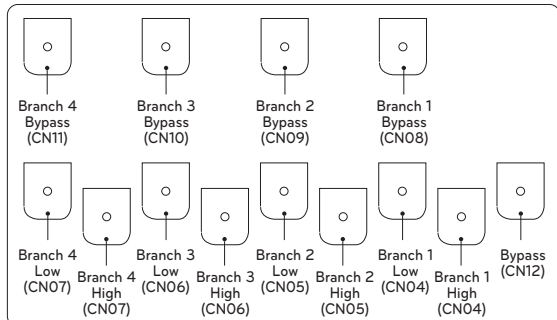

Position label of the solenoid coil (PRHR042A)

# JOINT METHOD OF HR UNIT

Joint Method is required when use indoor unit that exceed 54k is installed. In Joint Method, two neighboring outlets of one HR unit are linked by Y branch pipe and connected to one indoor unit.

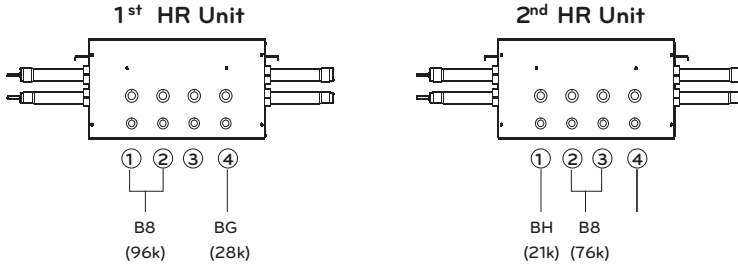

## ! NOTICE

1. A connection to un-neighboring pipes is forbidden. Do not link more than 2 outlets.

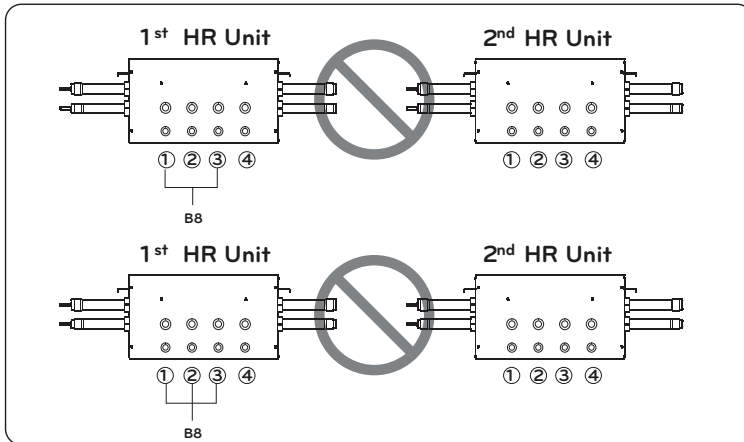

2. The B8 unit, which has the largest capacity, must be connected to the 1st and 2nd outlets of the 1st HR unit. Other B8 units can be connected to any two neighboring outlets within one HR unit.

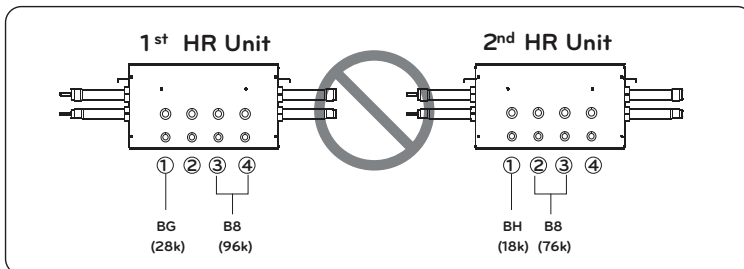





|        |  |
|--------|--|
| US     | Please call the installing contractor of your product, as warranty service will be provided by them.                     |
| CANADA | Service call Number # : (888) LG Canada, (888) 542-2623<br>Numéro pour les appels de service : LG Canada, 1-888-542-2623 |