

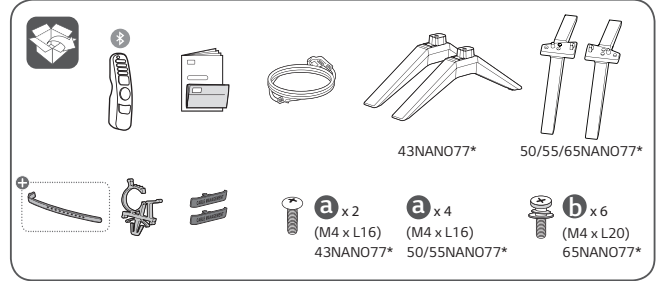

43NANO77SRA 55NANO77SRA
50NANO77SRA 65NANO77SRA



⊕ Dependendo do modelo

43/50/55NANO77* 1

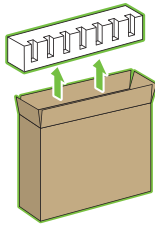

2

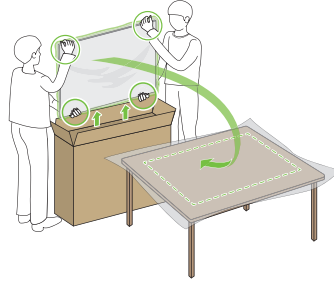

3

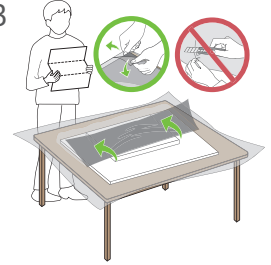

65NANO77* 1

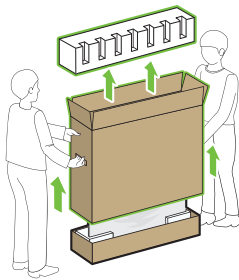

2

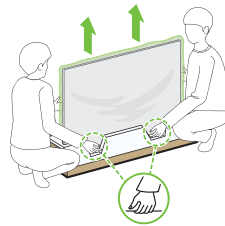

3

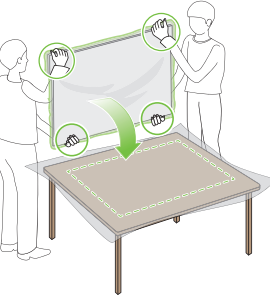

4

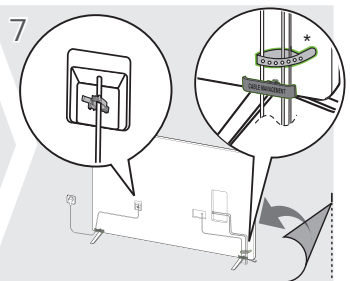
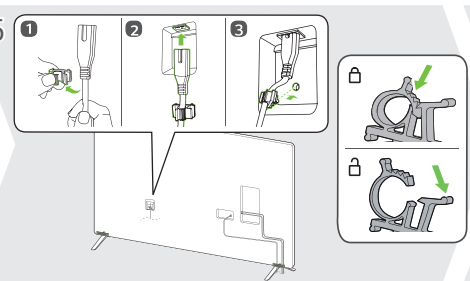
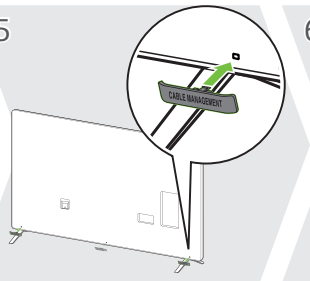
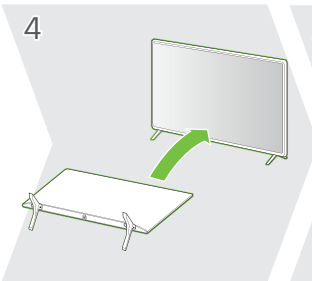
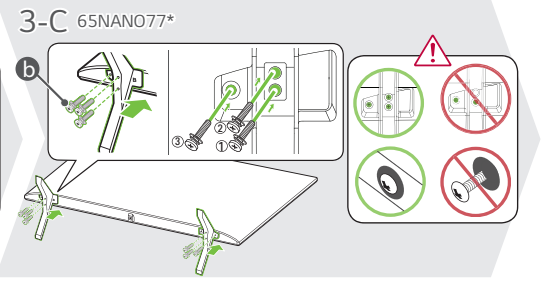
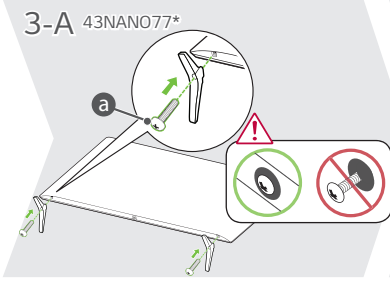
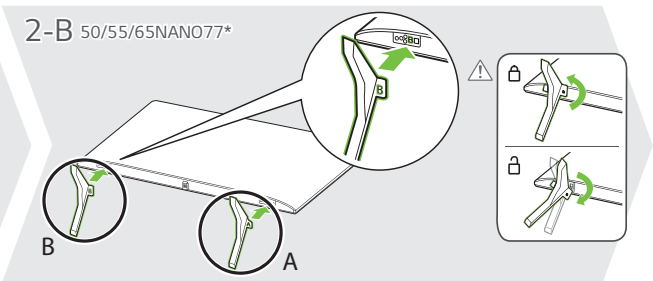
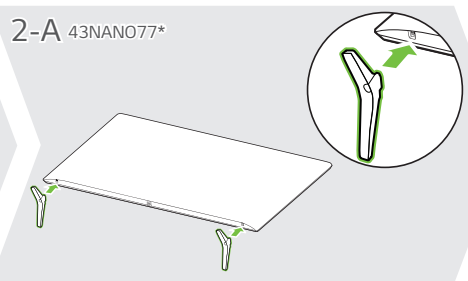
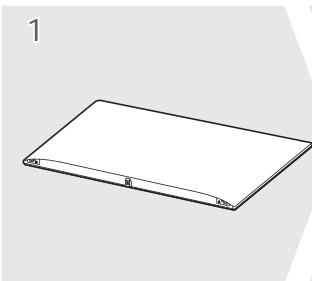
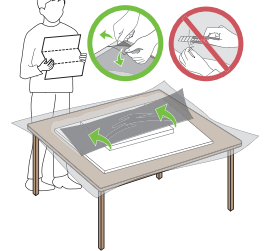

*Dependendo do modelo

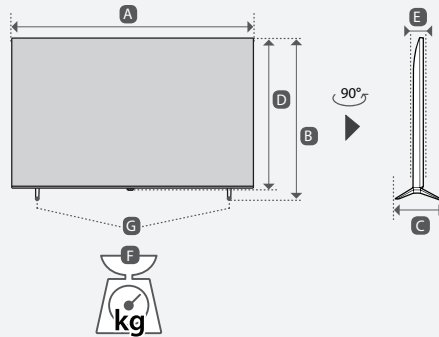
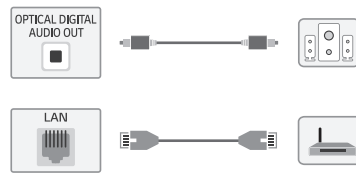
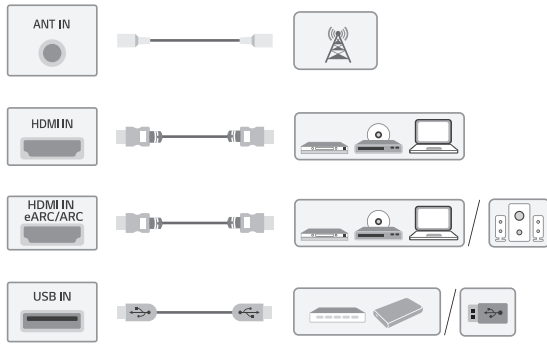

PRODUZIDO NO POLO INDUSTRIAL DE MANAUS
 CONHEÇA A AMAZÔNIA
LG Electronics do Brasil Ltda.
 CNPJ: 01.166.372/0008-21
 Rua Javari, nº 1004, Distrito Industrial, CEP 69075-110, Manaus/AM, Indústria Brasileira

MODELOS	A	B	C	D	E	F	F - G	Consumo de potência
43NANO77SRA	967 mm (38) pol.	621 mm (24.4) pol.	200 mm (7.8) pol.	564 mm (22.2) pol.	57.1 mm (2.2) pol.	8.9 kg (19.6) lbs	8.8 kg (19.4) lbs	110 W
50NANO77SRA	1 121 mm (44.1) pol.	716 mm (28.1) pol.	230 mm (9) pol.	651 mm (25.6) pol.	57.1 mm (2.2) pol.	11.8 kg (26.0) lbs	11.7 kg (25.7) lbs	130 W
55NANO77SRA	1 235 mm (48.6) pol.	780 mm (30.7) pol.	230 mm (9) pol.	715 mm (28.1) pol.	57.5 mm (2.2) pol.	14.1 kg (31.0) lbs	14.0 kg (30.8) lbs	160 W
65NANO77SRA	1 454 mm (57.2) pol.	903 mm (35.5) pol.	269 mm (10.5) pol.	838 mm (32.9) pol.	57.7 mm (2.2) pol.	21.7 kg (47.8) lbs	21.5 kg (47.3) lbs	200 W

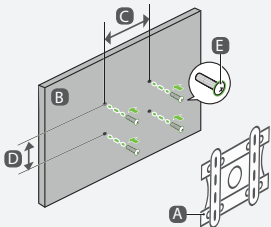

A	B	C x D	E
LSW240B	43NANO77*	200 x 200 mm	
MSW240	50NANO77*	(7.8 x 7.8) pol.	M6
OLW480B	55NANO77*	300 x 300 mm	
MSW240		(11.8 x 11.8) pol.	M6
OLW480B	65NANO77*	300 x 300 mm	
		(11.8 x 11.8) pol.	M6

A / E Não incluso no produto

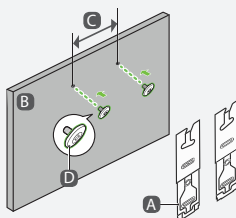
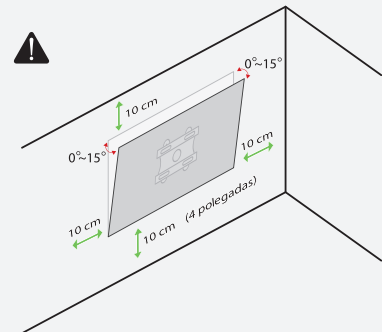

A	B	C	D
WB21LMB	43NANO77*	200 mm	
	50NANO77*	(7.8) pol.	M6
WB21LMB	55NANO77*	300 mm	
	65NANO77*	(11.8) pol.	M6

A / D Não incluso no produto