



OWNER'S MANUAL

Safety and Reference

Wall Mount Bracket

Please read this manual carefully before operating your set and retain it for future reference.

WB21LMB



<https://youtu.be/ytLFCUqUsz0>



* M F L 7 1 7 7 2 4 0 2 *

(2108-REV03)

www.lg.com

Copyright © 2021 LG Electronics Inc. All Rights Reserved.

Accessories

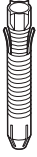

Wall mount fixing anchors
4 pcs.

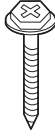

Wall mount fixing screws
4 pcs.

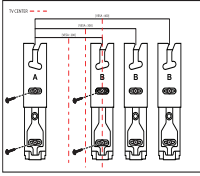

Guide paper

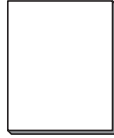

Installation Manual

5-1) Separation distance between TV and wall: 13 mm



TV protection cushion A 2 pcs.



TV fixing screws A 2 pcs.

5-2) Separation distance between TV and wall: 39 mm



TV protection cushion B 2 pcs.

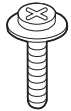

Guide Spacer Fixing Screws 2 pcs.
(M6 x L45)



Guide Spacer 2 pcs.

Precautions for Safety

- Professional installers should read this manual carefully to ensure proper installation.
- Professional installers should forward this manual to customers after installation and encourage them to read and store it in a convenient place for future reference.

After reading the installation manual, keep it in a convenient place for future reference.

Warning

Ask a professional installer appointed by the store for installation of the product.

Installation by someone other than a professional installer is extremely dangerous and may result in personal injury.

Contact a professional installer appointed by the store prior to moving or replacing the product after installation.

Installation is a technical task and safety issues may arise if an individual attempts to install or move the product personally.

When installing the product on a wall, do not hang the power line or signal cables from the back of the TV.

This can damage the cords, resulting in a fire, electrical shock or malfunction of the product.

Do not install the product in an unstable site that cannot withstand its weight.

If the installation site lacks sufficient rigidity, the product may fall and cause personal injury.

Do not hang on the product or subject it to severe impact after installation.

Doing so may cause the product to fall and cause personal injury.

Caution

Install the product according to the instructions in the installation manual.

Failure to install the product according to the instructions in the installation manual can result in serious personal injury or product damage.

Be sure to have at least two people when installing the product or adjusting the product's height.

Attempting to perform installation or adjustments personally may result in personal injury or damage to the product.

Make sure a wall is available prior to proceeding with installation. Make use of the anchors and screws provided with the product.

Use of any unauthorized anchors or screws may not support the product's weight, which poses safety risks.

When drilling in the wall for installation, be sure to use drill bits and drills of the specified diameter. Follow the instructions for the hole depth.

Drilling and installing the product in ways other than specified in the installation manual may result in an unstable installation and potential safety issues.

Do not wipe the product with a wet towel or use any heating equipment or humidifier under the place where the product is installed.

Liquid water or vapor may enter the product and excessive heat may cause fire, electric shock, or malfunction.

Do not install the product near a fire sprinkler or detector, a place where vibration or shock may occur or near a high-voltage wire or power source.

Unplug the product's power cord from the wall outlet before installing.

Installing the product while the power cord is plugged in may result in electric shock or fire.

Do not install the product with bare hands. Be sure to wear work gloves.

Attempting installation without work gloves may cause personal injury.

Connect the product with the supplied cable.

Use of an unauthorized cable may result in damage by friction with the wall. Make sure to use the supplied cable gender. (This may vary by model.)

Before Installation

- Do not use the product for any purpose other than installing the TV on a wall.
- Avoid product damage and safety accidents caused by careless installing or use of improper or unauthorized wall mount.
- Follow the instructions in the installation manual for a convenient installation of the wall mount.
- Immediately discontinue installation and contact the service center if you cannot fully understand the installation process.
Use a professional installer if any installation issues remain after the inquiry.
- Installation of this product on a concrete wall or wood stud is recommended. Installation on walls made of other types of plasterboard, plywood, brick, etc., is not recommended since there is a greater chance the product will fall.

- When installing the Full Contact Wall Mount, the TV may not be contacted firmly against the wall due to some wall conditions.
- Install the product only on a vertical wall. Do not install on a tilted wall that exceeds building standards or on the heavily tiled wall or ceiling. LG is not responsible for problems caused by improper installation of the product, e.g., heavily tilted walls and ceilings.
- Check the enclosed accessories before installation. We are not responsible for any lost or damaged accessories after the inner packaging is opened.
- When an infant or small child swallows the enclosed accessories, various safety accidents such as choking may occur. Keep the enclosed accessories out of the reach of infants and children.
- When tightening screws, tighten until fully snug. Avoid using excessive force when tightening the screws. Doing so may damage the wall and product or reduce the rigidity or performance of the product.
- Avoid installing a TV that exceeds the specified tensile load, and do not allow any external force to be applied to the product.
- Avoid accidents by using work tools with care during installation.
- After installing the product, ensure its use in close contact with a wall. If the product is not positioned against a wall, the product may be unstable or damaged.

Tools for Installation

- "+" shaped screwdriver (manual or electric)
- level
- drill
- Ø 8 mm drill bit for concrete or Ø 4 mm drill bit for steel

How to install

- The appearance of tools may differ from the enclosed images.
- Always consult a professional when installing a wall mount.

1. Wearing gloves

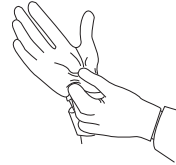

2. Fastening Anchors and Screws

- Check that the material and thickness of the wall and finishing material comply with the installation manual. Before beginning the mounting process, you must be sure the wall is able to support the weight of the TV.
- Should use the enclosed anchors and screws on crack free concrete walls.
- If the wall is not made of concrete, the wall mount must be installed on a rigid support. Never install the product on a plasterboard or wall made of paper or medium-density fiberboard (MDF). In this case, make sure that the wall material can withstand the weight of the TV, and fix the anchor screws to the retaining wall (concrete) or wooden support behind the finishing material. Since the anchors provided with this product may not be suitable for your wall material, be sure to check with a professional before attempting installation.
- Other unspecified walls must be capable of supporting pullout loads of over 70 kgf (686 N) and shear loads of over 100 kgf (980 N) per fastener.
- Use an Ø 8 mm drill bit for concrete and a hammer (impact) drill or Ø 4 mm drill bit for wood stud to drill holes.

For installation on concrete wall

1. Drill holes in anchor locations with a drill bit of $\varnothing 8$ mm to a depth of 80 mm to 100 mm.

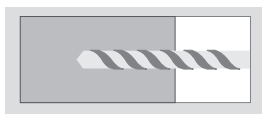

2. Clean the drilled holes.

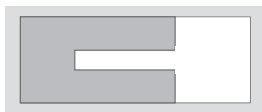

3. Insert the enclosed anchors for fixing the wall mount into the holes. (Use a hammer when inserting anchors.)

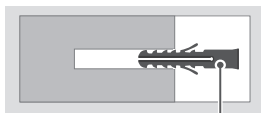

Anchors for fixing the wall mount

4. Push the wall mount support closely toward the wall to match the hole locations.

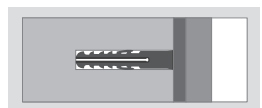

5. Tighten screws for fixing the wall mount to the holes. At this time, tighten the screws with the torque more than 45 kgf/cm to 60 kgf/cm.

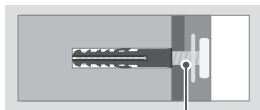

Screws for fixing the wall mount

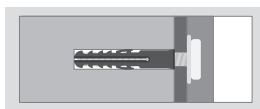

For installation on wood stud

Use the $\varnothing 4$ mm drill bit for wood to drill holes with the depth of 76 mm. (Clean the drilled hole.)

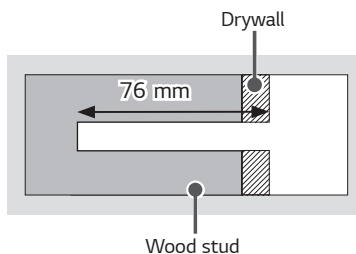

Without using the wall mounting anchor, fasten the wall mounting screw directly to the wood stud.

3. Attaching the guide paper to the wall

Attach the guide paper to the wall when determining the TV's installation site.

- Ensure the guide paper is level when attaching it to the wall.
- Attach it by referring to the outer line of the TV and the location of the TV center.

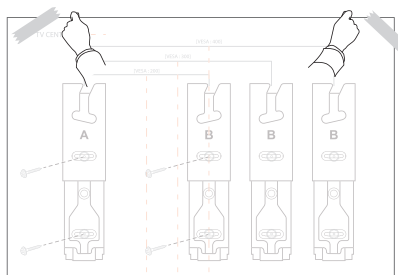

4. Installing the Wall Mount Support

- Install A on the left and B on the right according to the markings on the wall mount.
- Refer to the following picture to fix the wall mount support.
- Use a level to verify that the wall mount is positioned horizontally.
- Fix the wall mount screws: one at the top and one at the bottom.
- Use a Phillips screwdriver (manual or powered) to tighten the screws so that the wall mount support is firmly fixed to the wall surface.

1. Check the shape of the wall mount in the picture.

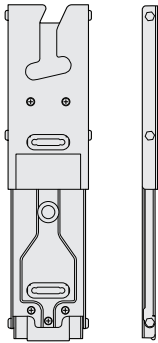

2. Install the wall mount support at the location marked on the guide paper.

- Install after checking the VESA size for the model you purchased.

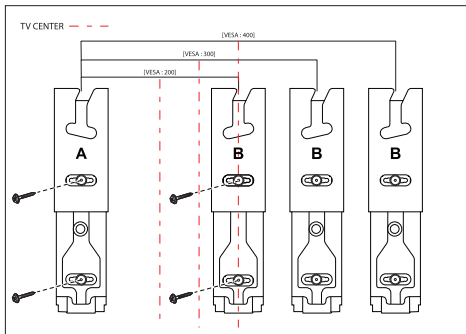

3. In the order, unfold the wall mount by pulling the parts indicated in the picture.

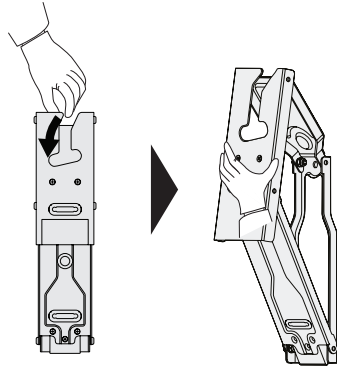

4. Remove the guide paper.

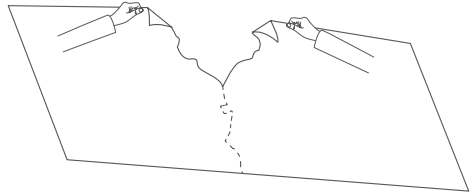

5. Attaching the TV to the Wall Support

5-2 is recommended for models with horizontal terminals, 5-1 is recommended for models without horizontal terminals, and when installing by 5-2, side terminals are recommended for HDMI & USB.

5-1) Separation distance between TV and wall: 13 mm

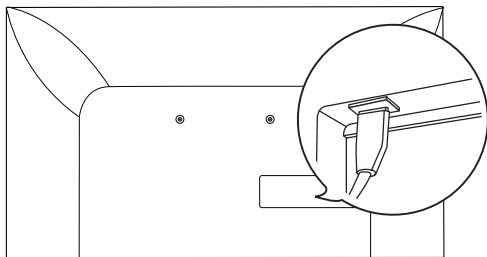

1. Fasten the enclosed TV fixing screws A to both sides of the top of VESA on the TV.

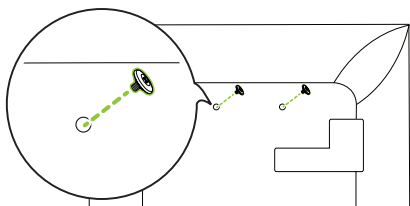

2. Attach the enclosed TV protective cushion A to the bottom of the flat surface behind the TV. (The location may differ depending on the model.)

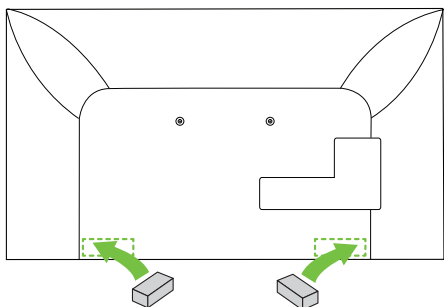

3. After attaching the TV to the mount on the wall, fasten the screws fixed to the TV to the wall mount. Caution: Ensure two or more people work together when mounting the TV. (If the product is lifted by one person, it may fall and result in injury or damage.)

Be careful not to trap the power cord between the wall mount bracket and the TV when mounting the TV. (If the power cord becomes trapped, it may result in product damage.)

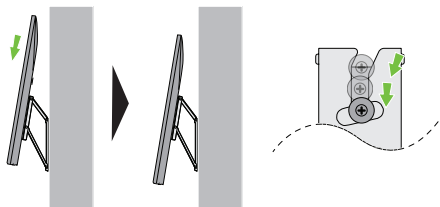
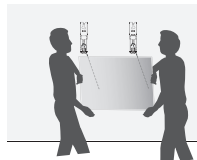

4. Push the TV close to the wall. Be sure to gently push the upper and lower parts of the TV so that the pushing doesn't affect the TV. Gently push the upper center of the TV once again until it's completely pressed against the wall.
Caution: Do not apply excessive force to the screen. (Doing so can damage the screen.)

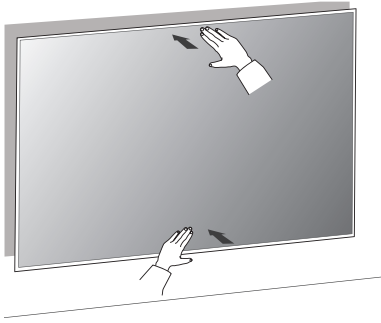
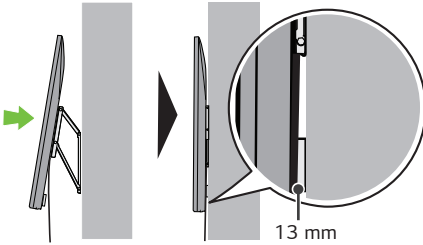

5. Adjust the product's position by hand so it's horizontal. Hold the left and right bottom sides of the TV and adjust it to the desired direction.

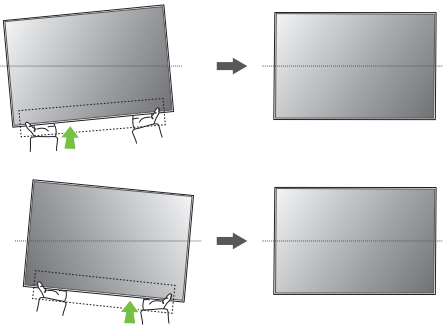

5-2) Separation distance between TV and wall: 39 mm

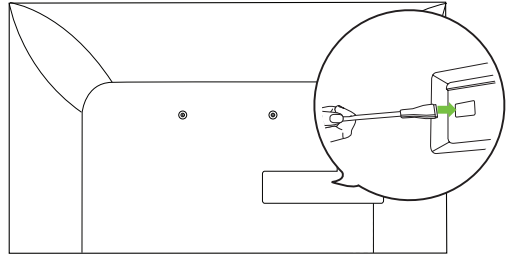

1. Fasten the enclosed TV guide spacers and guide spacer fixing screws to both sides of VESA.

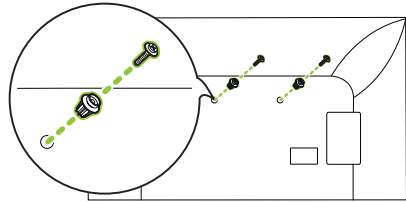

2. Attach the enclosed TV protective cushion B to the bottom of the flat surface behind the TV. (The location may differ depending on the model.)

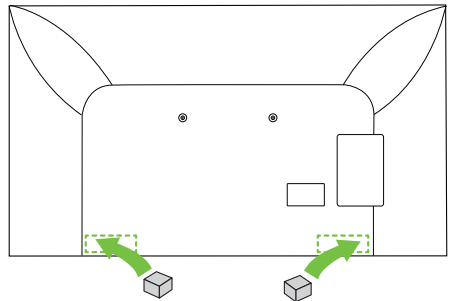

3. After attaching the TV to the mount on the wall, fasten the screws fixed to the TV to the wall mount. Caution: Ensure two or more people work together when mounting the TV. (If the product is lifted by one person, it may fall and result in injury or damage.)

Be careful not to trap the power cord between the wall mount bracket and the TV when mounting the TV. (If the power cord becomes trapped, it may result in product damage.)

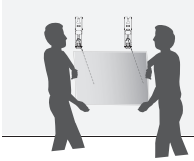

4. Push the TV close to the wall. Be sure to gently push the upper and lower parts of the TV so that the pushing doesn't affect the TV. Gently push the upper center of the TV once again until it's completely pressed against the wall. Caution: Do not apply excessive force to the screen. (Doing so can damage the screen.)

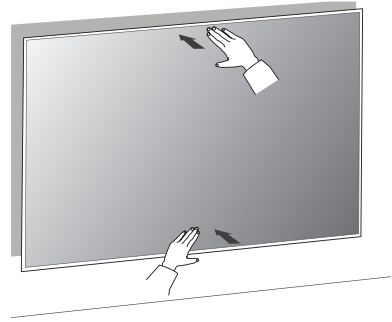
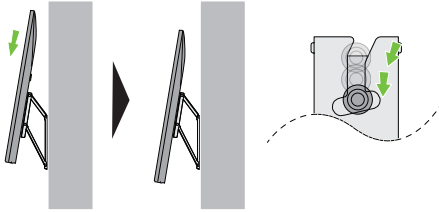
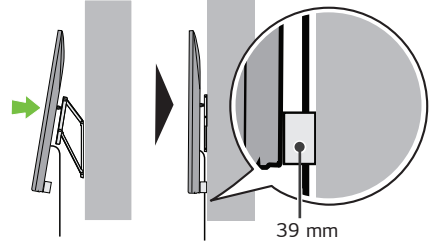

5. Adjust the product's position by hand so it's horizontal. Hold the left and right bottom sides of the TV and adjust it to the desired direction.

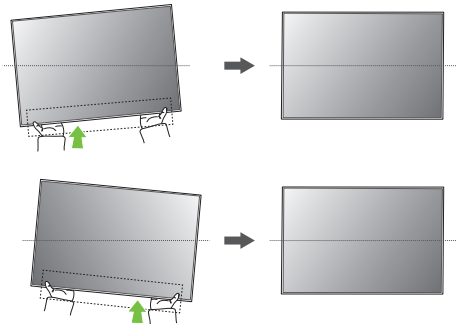

6. Plugging Additional Cables in While Using the TV

1. While holding the lower part of the TV, pull the upper side of the TV so it does not affect the product. Gently pull the upper and lower parts of the TV and check the position to connect the cable from the side.

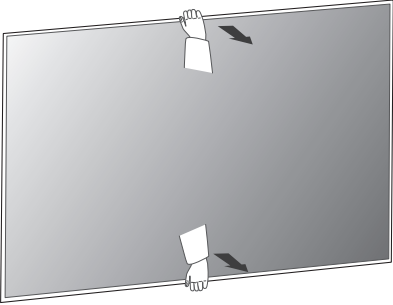

2. Check the position of the cable from the side and plug it into the TV. Position your body as close to the wall as possible behind the TV and organize the cables using the holder. (The location of the cable connection terminal may differ depending on the model.)

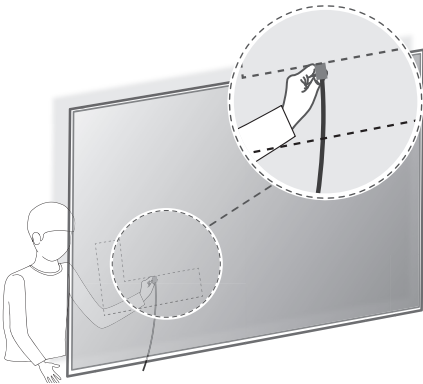

3. Push the TV close to the wall. Be sure to gently push the upper and lower parts of the TV so that the pushing doesn't affect the TV. Gently push the upper center of the TV once again until it's completely pressed against the wall.
Caution: Do not apply excessive force to the screen. (Doing so can damage the screen.)

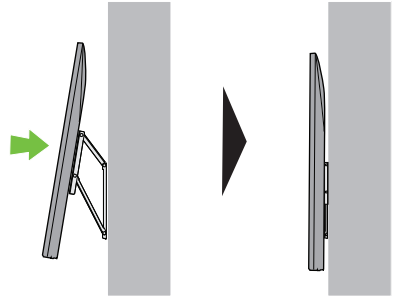
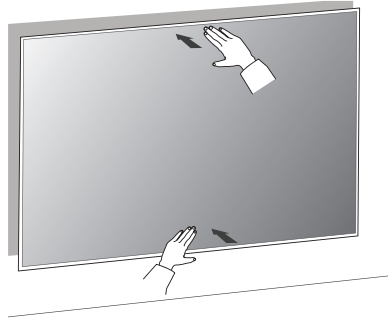

Specifications

[Unit : mm]

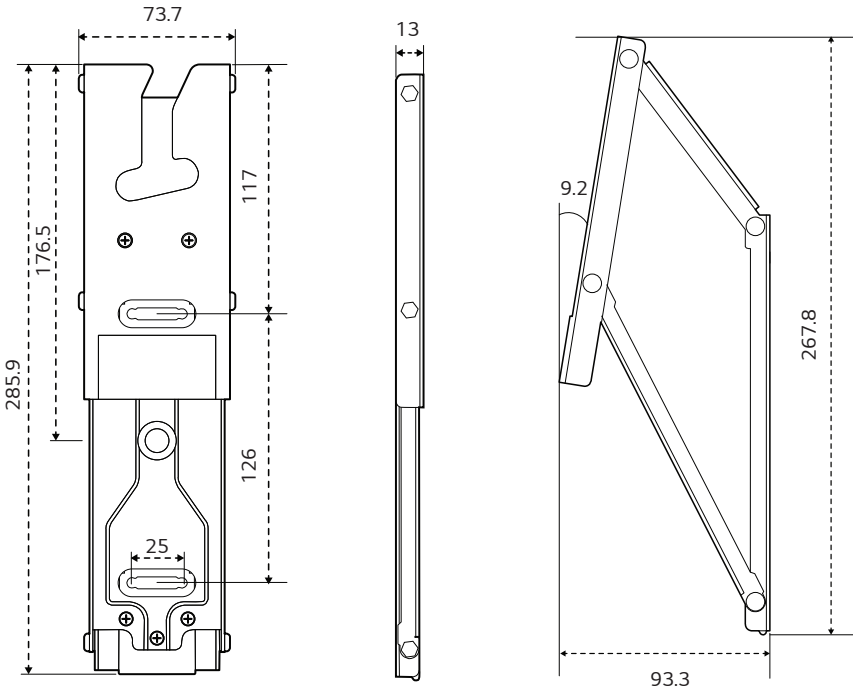

Model Name	WB21LMB
Width (mm)	73.7
Height (mm)	285.9
Depth (mm)	13
Product Weight (kg)	0.6 x 2
Screws Distance (mm) (65" ↓)	200/300/400
Max. Tensile Load (kg)	50



6. 在使用電視時插入其他纜線

1. 抓住電視下部時，拉動電視上部，以免影響產品。輕拉電視的上部和下部，從側面檢查連接纜線的位置。

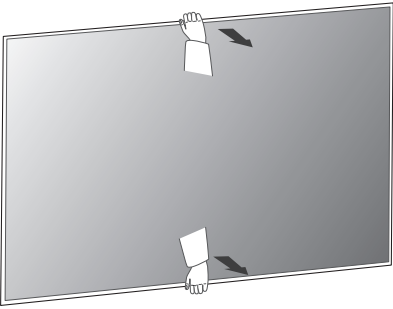

2. 從側面檢查纜線位置，將纜線插入電視。在電視後方讓身體盡可能靠近牆壁，使用固定器整理纜線。(纜線連接端子的位置可能因型號而異。)

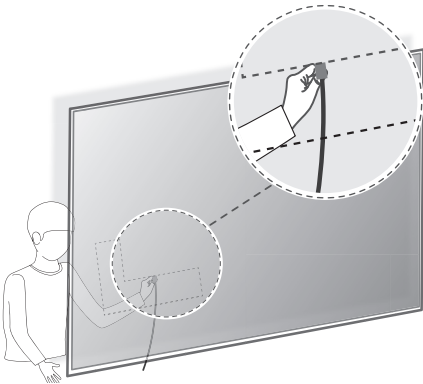

3. 將電視推向牆壁。請務必輕推電視的上部和下部，以免推動影響電視。再次輕推電視的上部中心，直到完全貼在牆上。
警示：請勿對螢幕過度施力。(否則可能損壞螢幕。)

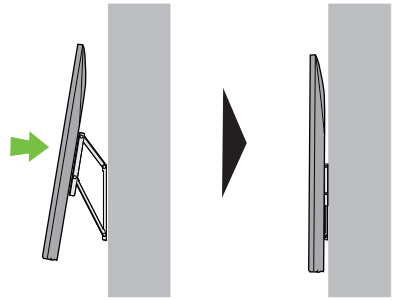
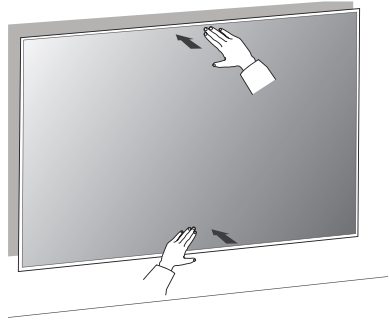

規格

[單位：公釐]

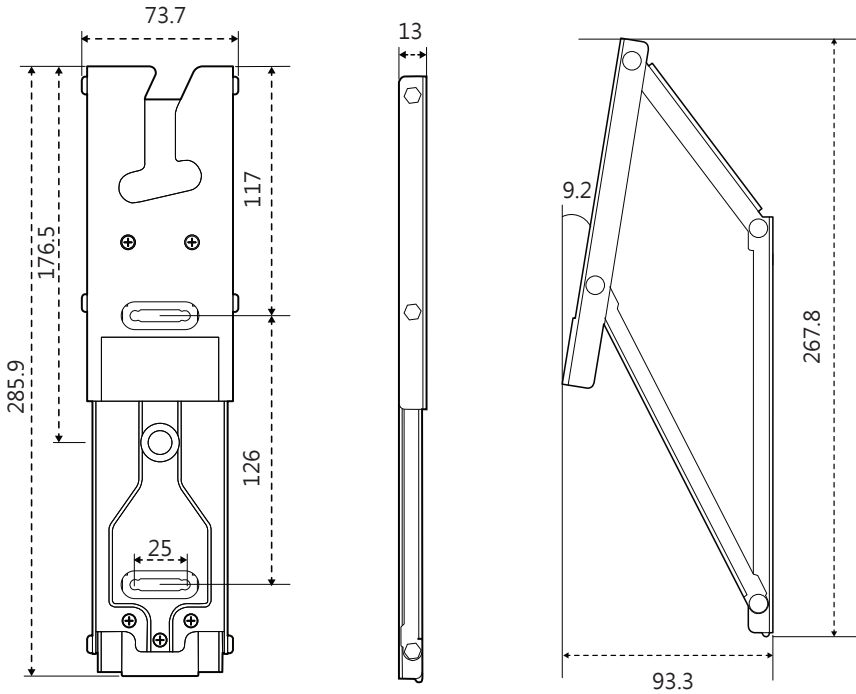

機型名稱	WB21LMB
寬度 (公釐)	73.7
高度 (公釐)	285.9
深度 (公釐)	13
產品重量 (公斤)	0.6 x 2
螺絲距離 (公釐) (65°↓)	200/300/400
最大拉力負荷 (公斤)	50

