



OWNER'S MANUAL

AIR CONDITIONER



Read this owner's manual thoroughly before operating the appliance and keep it handy for reference at all times.

ENGLISH

Wall Mounted

MFL72146103
Rev.02_121725

EAC 
www.lg.com

Copyright © 2024-2025 LG Electronics. All Rights Reserved

TABLE OF CONTENTS

This manual may contain images or content that may be different from the model you purchased.
This manual is subject to revision by the manufacturer.

IMPORTANT SAFETY INSTRUCTIONS

- READ ALL INSTRUCTIONS BEFORE USE 4**
 - Safety Messages.....4
- WARNING INSTRUCTIONS 4**
 - Technical Safety.....4
 - Installation6
 - Operation7
 - Wireless Remote Control.....8
 - Maintenance8
 - Refrigerant.....9
- CAUTION INSTRUCTIONS 9**
 - Installation9
 - Operation10
 - Maintenance11

OPERATION

- Before Use 12**
 - Notes for Operation.....12
 - Suggestions for Energy Saving.....12
- Product Overview 13**
 - Wall-Mounted Unit.....13
 - Manual Operation14
 - Auto Restart Function.....14
 - Fan Speed and Cooling Capacity.....15
- Preparing before Operation 15**
 - Inserting the Batteries into the Wireless Remote Control.....15
 - Installing the Remote Control Holder15
 - Setting the Current Time on the Wireless Remote Control16
 - Selecting Fahrenheit or Celsius.....16
- Wireless Remote Control Overview 17**
 - Wireless Remote Control.....17
- Using Wireless Remote Control 21**
 - Operating with the Wireless Remote Control.....21

Cooling, Auto, Dehumidification, Heating, Fan Mode	21
Jet Mode	22
Adjusting the Fan Speed	23
Adjusting the Airflow Direction	23
On and Off Timer	24
Sleep Function (On Some Models)	26
Light Off Function (On Some Models)	27
Energy Saving Function (On Some Models).....	27
Checking Room Temperature.....	27

Special Functions Overview 29

Special Functions.....	29
------------------------	----

Using Special Functions 30

Setting and Cancelling Special Functions.....	30
Auto Clean Function (On Some Models).....	30

MAINTENANCE

Cleaning..... 31

Cleaning Interval	31
Cleaning the Air Filter	33
Replace Picture or Photograph	34

Tips for Maintenance 35

Before Long Periods of Disuse	35
After Long Periods of Disuse	35

TROUBLESHOOTING

Before Calling for Service 36

Self-Diagnosis Function	36
Operation	36
Performance	39

Calling for Service 40

Situations in which Calling for Service is Necessary	40
--	----

IMPORTANT SAFETY INSTRUCTIONS

READ ALL INSTRUCTIONS BEFORE USE

Safety Messages



This symbol is displayed to indicate matters and operations that can cause risk.

Read the part with this symbol carefully and follow the instructions in order to avoid risk.



WARNING

This indicates that the failure to follow the instructions can cause serious injury or death.



CAUTION

This indicates that the failure to follow the instructions can cause the minor injury or damage to the product.

WARNING INSTRUCTIONS

WARNING

- To reduce the risk of explosion, fire, death, electric shock, injury or scalding to persons when using this product, follow basic precautions, including the following:

Technical Safety

- This appliance can be used by children aged from 8 years and above and persons with reduced physical, sensory or mental capabilities or lack of experience and knowledge if they have been given supervision or instruction concerning use of the appliance in a safe way and understand the hazards involved. Children shall not play with the appliance. Cleaning and user maintenance shall not be made by children without supervision.
- This appliance is not intended for use by persons (including children) with reduced physical, sensory or mental capabilities, or lack of

experience and knowledge, unless they have been given supervision or instruction concerning use of the appliance by a person responsible for their safety. Children should be supervised to ensure that they do not play with the appliance.

- Installation or repairs made by unauthorized persons can pose hazards to you and others.
- The information contained in the manual is intended for use by a qualified service technician who is familiar with the safety procedures and equipped with the proper tools and test instruments.
- Failure to read and follow all instructions in this manual can result in equipment malfunction, property damage, personal injury and/or death.
- The refrigerant and insulation blowing gas used in the appliance require special disposal procedures. Consult a service agent or a similarly qualified person before disposing of them.
- When the power cord is to be replaced, the replacement work shall be performed by authorized personnel using only genuine replacement parts.
- If the supply cord is damaged, it must be replaced by the manufacturer or its service agents or a similarly qualified person in order to avoid a hazard.
- The appliance shall be installed in accordance with national wiring regulations.
- This appliance must be properly grounded.
- Do not cut or remove the grounding prong from the power plug.
- Attaching the earth wire to the power outlet cover screw does not ground the appliance unless the cover screw is metal, uninsulated, and the power outlet is grounded through house wiring.
- If you have any doubt whether the air conditioner is properly grounded, have the power outlet and circuit checked by a qualified electrician.

Installation

- Contact an authorized service centre when installing or relocating the air conditioner.
- Contact the dealer, seller, qualified electrician or authorized service centre for cleaning or maintenance the air conditioner.
- Do not install, remove, or re-install the unit by yourself (customer). Installation or repairs done by unauthorized persons can pose hazards to you and others.
- For electrical work, contact the dealer, seller, a qualified electrician or an authorized service centre.
- Do not attempt to do electrical work or grounding work unless you are licensed to do so. Consult with the dealer for electrical work and grounding work.
- Do not install the product on a defective installation stand.
- Be sure the installation area does not deteriorate with age.
- Be sure to only use accessories made by LG which are specifically designed for use with the equipment and have them installed by a professional.
- Never install the outdoor unit on a moving base or a place from where it can fall down.
- Do not install the unit in potentially explosive atmospheres.
- Do not install the air conditioner in a place where flammable liquids or gases such as gasoline, propane or paint thinner are stored.
- Install the panel and the cover of the control box safely.
- Install a dedicated electric outlet and earth leakage breaker before using the appliance.
- Use a standard circuit breaker and fuse that conform to the rating of the air conditioner.
- Do not use a multiple socket, extension power cable or adapter with this appliance.
- The indoor/outdoor wiring connections must be secured tightly, and the cable should be routed properly so that there is no force pulling

the cable from the connection terminals. Improper or loose connections can generate heat or cause a fire.

- Do not connect the ground wire to a gas pipe, a lightning rod, or a telephone ground wire.
- Use non-flammable gas (nitrogen) to check for leaks and to purge air; using compressed air or flammable gas may cause fire or explosion.

Operation

- Do not modify or extend the power cable. Scratches or peeling insulation on the power cables may result in fire or electric shock, and the cables should be replaced.
- Make sure that the power cable is neither dirty, loose, nor broken.
- Do not place any objects on the power cable.
- Take care to ensure that the power cable could not be pulled out or damaged during operation.
- Never touch, operate, or repair the air conditioner with wet hands.
- Do not insert hands or other objects through the air inlet or outlet while the air conditioner is operating.
- Make sure that nobody, especially children, climbs on or hits the outdoor unit.
- Be sure to use only those parts listed in the service parts list. Never attempt to modify the equipment.
- Do not touch the refrigerant pipe, water pipe or any internal parts while the unit is operating or immediately after operation.
- Do not leave flammable substances such as gasoline, benzene, or thinner near the air conditioner.
- Do not use the air conditioner for an extended period of time in a small place without proper ventilation.
- Be sure to ventilate sufficiently when the air conditioner and a heating appliance such as a heater are used simultaneously.
 - There is the possibility of oxygen deficiency.
- Do not block the inlet or outlet airflow.

- Cut off the power supply if there is any noise, smell, or smoke coming from the air conditioner.
- Contact an authorized service centre if the air conditioner is submerged by flood waters.
- In the event of a gas leak (such as Freon, propane gas, or LP gas), ventilate sufficiently before using the air conditioner again.
- Stop operation and close the window during a storm or hurricane. If possible, remove the product from the window before the hurricane arrives.

Wireless Remote Control

- Never mix different types of batteries, or old and new batteries in the remote control.
- Do not recharge or disassemble the batteries.
- Dispose of the batteries in a place where there is no danger of fire.
- Stop using the remote control if there is a fluid leak in the battery. If your clothes or skin is exposed to the leaking battery fluid, wash off with clean water.
- If the leaking battery fluid has been swallowed, rinse the inside of the mouth thoroughly and consult a doctor.
- Never let the indoor unit or the remote control get wet.

Maintenance

- Before cleaning or performing maintenance, disconnect the power supply and wait until the fan stops.
 - The fan rotates at a very high speed during operation.
 - There is a possibility of injury if the unit's power is accidentally triggered on while you are cleaning the inner parts of the unit.
- Appliance shall be disconnected from its power source during service and replacing parts.

Refrigerant

- Follow the standards of the corresponding region or country for handling the refrigerant and the air conditioner and for disassembling the air conditioner.
- Use only the refrigerant specified on the air conditioner label.
- Do not input air or gas into the system except the specified refrigerant.
- Do not touch the leaking refrigerant during installation or repair.
- If the refrigerant gas leaks during the installation, ventilate the area immediately.
- Be sure to check for refrigerant leaks after installing or repairing the product.
- In the case of refrigerant leakage, consult the dealer. When the air conditioner is to be installed in a small room, it is necessary to take proper measures so that the amount of any leaked refrigerant does not exceed the limiting concentration even when it leaks. If the refrigerant leaks exceeding the level of limiting concentration, an oxygen deficiency accident may happen.

CAUTION INSTRUCTIONS

CAUTION

- To reduce the risk of minor injury to persons, malfunction, or damage to the product or property when using this product, follow basic precautions, including the following:

Installation

- Use a forklift or 2 or more people to transport the air conditioner.
- Do not install the air conditioner in an area where it is directly exposed to sea wind (salt spray).
- Install the drain hose properly for the smooth drainage of water condensation.

- Install the air conditioner in a place where the noise from the outdoor unit or the exhaust fumes will not inconvenience the neighbours.
- Safely dispose of packing materials such as screws, nails, plastic bags or batteries using proper packaging after installation or repair.
- Exercise caution when unpacking or installing the air conditioner.
- Be especially careful of the case edges and the fins on the condenser and evaporator.
- To avoid vibration or water leakage, keep the product level even when installing it.
- When installing the unit, use the installation kit provided with the product.
- The edges of heat exchanger fins are sharp enough to cut. To avoid injury, wear gloves or cover the fins while working around them.

Operation

- Do not drink the water drained from the air conditioner.
- Do not place objects in direct proximity to the outdoor unit and do not let leaves and other debris accumulate around the unit. Leaves are a hotbed for small animals which can enter the unit. Once inside the unit, such animals can cause malfunctions, smoke or fire if they come into contact with electrical parts.
- Do not let the air conditioner run for a long time when humidity is very high or when a door or a window has been left open.
- Do not expose people, animals, or plants to the cold or hot wind from the air conditioner for extended periods of time.
- Do not use the product for special purposes, such as preserving foods, works of art, etc. The air conditioner is designed for consumer purposes, and is not a precision refrigeration system. There is risk of damage or loss of property.
- Do not turn on the breaker or power when the front panel, cabinet, top cover, or control box cover are removed or opened.
- Do not open the front grille of the product during operation. Do not touch the electrostatic filter, if the unit is so equipped.

- Take care to prevent water from entering the product.
- Make sure that there are no obstacles close to the outdoor unit. The presence of obstacles close to the outdoor unit may reduce the performance of the outdoor unit or increase its operating sound.
- Do not turn off the power immediately after stopping operation. Always wait for at least five minutes before turning off the power.

Maintenance

- Use a sturdy stool or ladder when cleaning, maintaining, or repairing the air conditioner at a height.
- Do not plug or unplug the power supply plug to turn the unit on or off.
- Never use strong cleaning agents or solvents or spray water when cleaning the air conditioner. Use a soft cloth.
- Never touch the metal parts of the air conditioner when removing the air filter.
- Tear apart and throw away plastic packaging bags so that children will not play with them.
- When the product will not be used for a long time, disconnect the power supply plug or turn off the breaker.
- Do not tilt the unit when removing or uninstalling it. The condensed water inside can spill.
- Check the foundation for damage on a regular basis, especially if the product has been in use for a long time.
- Always insert the filter securely. Clean the filter every two weeks or more often if necessary. A dirty filter reduces the efficiency of the air conditioner and could cause product malfunction or damage.

OPERATION

Before Use

Notes for Operation

- Adjust the direction of the airflow vertically or horizontally to circulate indoor air.
- Speed up the fan to cool or warm indoor air quickly, within a short period of time.
- Turn off the appliance and periodically open windows for ventilation. The indoor air quality may deteriorate if the appliance is used for long periods.
- Clean the air filter once every 2 weeks. Dust and impurities collected in the air filter may block the airflow or reduce the appliance performance.

Suggestions for Energy Saving

- Do not over-cool the space. This may be harmful to your health and may consume more electricity.
- Block sunlight with blinds or curtains while you are operating the appliance.
- Keep doors or windows closed tightly while you are operating the appliance.

Product Overview

Wall-Mounted Unit

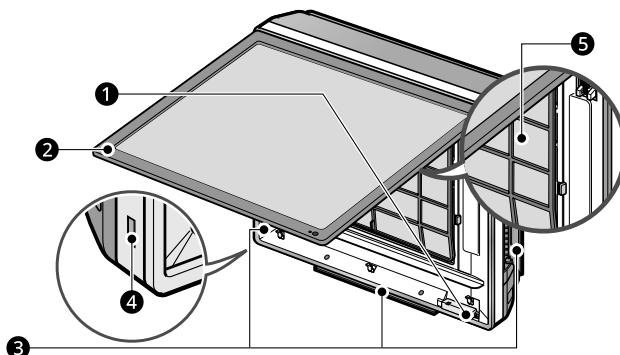

1 Wireless Remote Control Receiver

Contains the receiver for the wireless remote.

2 Front Panel

Protects the product.

3 Air Outlet Vents

Circulates air back into the room at the desired temperature.

4 Power Button

Turns the product on or off.

5 Air Filter

Adjusts the airflow direction left or right and reduces dust in the air.

NOTE

- The number and location of parts may vary depending on the model of the appliance.
- Features may change depending on the model type.

Manual Operation

If your wireless remote control is unavailable, turn the appliance on or off by pressing the **Power** button ❶ on the indoor unit.

- Press the **Power** button ❶.

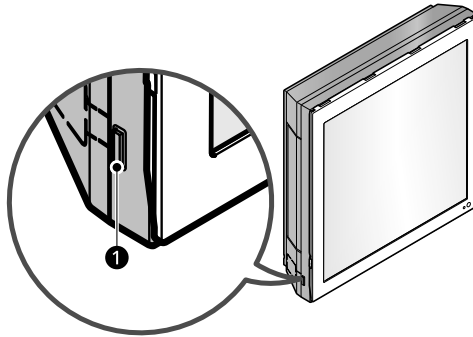

NOTE

- Features may change depending on the model type.
 - The temperature cannot be altered when using the **Power** button ❶.
-

Operating Test

- Press and hold the **Power** button ❶ for about 3 to 5 seconds.
 - The buzzer sound occurs 1 time.
-

NOTE

- The product operates in cooling mode at high fan speed, regardless of the room temperature, and resets in 18 minutes.
 - Using the remote during the operating test will interrupt the test and operate the product as set by the remote.
 - To stop the test, press the button again.
-

Auto Restart Function

The Auto Restart function automatically retains the previous operating settings in the case of a power outage.

- This function is useful in the case of power failure.
- This function is enabled by the factory default settings.

- If you want to set or disable the auto restart function, press and hold the **Power** Button ❶ for 6 seconds.

- You hear 2 beeps and the indicator light pulses 4 times.

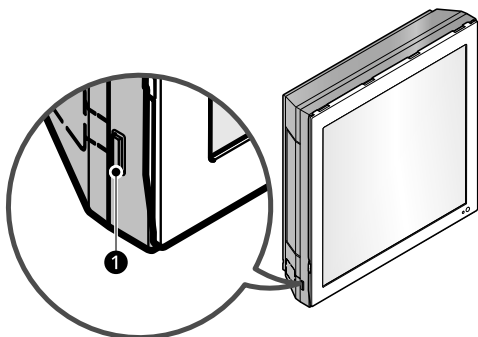

NOTE

- The product will automatically restart without the need to press any buttons.
- Upon restart, the fan will initially operate at a low speed until the compressor starts, 2 1/2 to 3 minutes later. Once the compressor starts, the fan will resume its previous setting.

Fan Speed and Cooling Capacity

The cooling capacity indicated in the specification is the value when the fan speed is set to high, and the capacity will be lower at low or medium fan speed. High fan speed is recommended when you wish to cool the room quickly.

Preparing before Operation

Inserting the Batteries into the Wireless Remote Control

Insert AAA (1.5 V) batteries into the wireless remote control.

- 1 Remove the battery cover and insert the new batteries, making sure that the + and -

terminals of the batteries are oriented correctly.

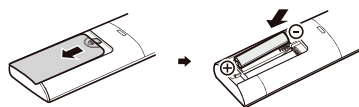

- 2 Reattach the cover by sliding it back into position.

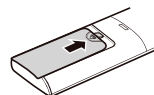

NOTE

- When the wireless remote control display begins to fade, replace the AAA (1.5 V) batteries.
- If the system is not going to be used for a long time, remove the batteries to save their working life.
- Do not use old and new batteries together.

Installing the Remote Control Holder

- 1 Choose a suitable place where its safe and easy to reach.
- 2 Fix the firmly to the wall with the supplied screws.

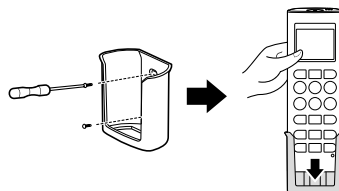

- 3 Slide the remote controller inside the holder.

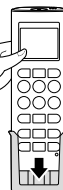

16 OPERATION

NOTE

- The remote controller should never be exposed to direct sunlight.
- The signal transmitter and receiver should always be clean for proper communication. Use a soft cloth to clean them.
- If other appliances are accidentally affected by the remote controller, change their position or consult your serviceman.

Setting the Current Time on the Wireless Remote Control

1 Insert the batteries.

- The time flashes at the bottom of the display screen.

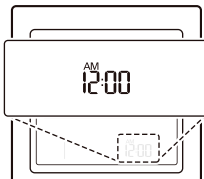

2 Press the or button to set the current time.

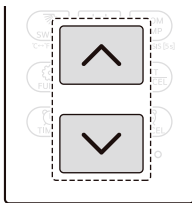

3 Press the **SET/CANCEL** button to stop the flashing.

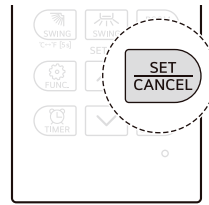

NOTE

- The **On Timer** and **Off Timer** are available after setting the current time.
- If you have already inserted the battery, reinsert it or use the reset button to set the current time.

Selecting Fahrenheit or Celsius

Set the temperature display to show either Fahrenheit (°F) or Celsius (°C) units.

1 Turn the appliance on.

2 Press and hold the **SWING (Up-Down Swing)** button for about 5 seconds to change units between °C and °F.

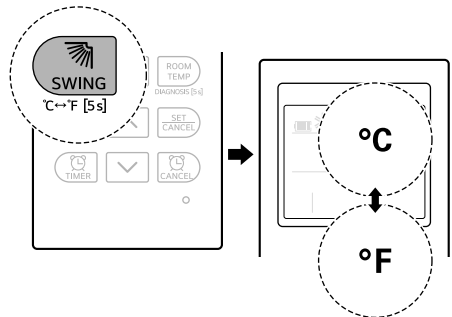

Wireless Remote Control Overview

Wireless Remote Control

Use the wireless remote control to operate the appliance more conveniently.

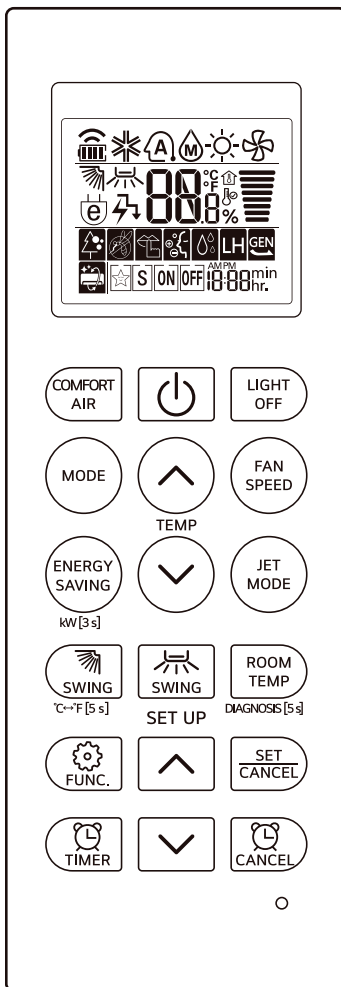

Buttons





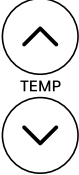















Image	Description
	<p>COMFORT AIR Adjusts the airflow to deflect wind</p>
	<p>Power  Turns the appliance on/off</p>
	<p>LIGHT OFF Turns the indoor unit display on or off</p>
	<p>MODE Selects the desired operating mode</p> <ul style="list-style-type: none"> Each press changes the modes in this order: Cooling → Auto → Dehumidification → Heating^{*1} → Fan.
	<p>Temperature Setting   Adjusts the desired temperature</p>
	<p>FAN SPEED Adjusts the fan speed</p>
 <p data-bbox="132 1042 187 1058">kW[3s]</p>	<p>ENERGY SAVING Minimizes power consumption</p> <hr/> <p>kW [3s] Press and hold the ENERGY SAVING button for about 3 seconds to select whether or not to display information regarding energy.</p>
	<p>JET MODE Changes the room temperature quickly</p>
 <p data-bbox="132 1303 187 1319">°C↔°F [5s]</p>	<p>SWING (Up-Down Swing) Adjusts the airflow direction up and down</p> <hr/> <p>°C ↔ °F [5s] (Selecting Fahrenheit or Celsius) Press and hold the SWING (Up-Down Swing) button for about 5 seconds to set the temperature display to show either Fahrenheit (°F) or Celsius (°C) units.</p>
	<p>SWING (Left-Right Swing)^{*1} Adjusts the airflow direction left and right</p>

Image	Description
 <small>DIAGNOSIS [5s]</small>	<p>ROOM TEMP (Room Temperature) Displays the room temperature</p> <hr/> <p>DIAGNOSIS [5s] Press and hold the ROOM TEMP (Room Temperature) button for about 5 seconds to easily check the check maintenance information of an appliance.</p>
	<p>FUNC. (Function) Sets the various function or changes the temperature unit</p>
 	<p>Timer Setting , </p> <p>Adjusts the time on the display</p>
	<p>SET/CANCEL Sets or cancels the special functions or timer</p>
	<p>TIMER Automatically turns the appliance on or off at a desired time</p>
	<p>CANCEL Cancels the timer settings</p>
	<p>RESET Resets the wireless remote control settings</p>

*1 This feature is only available on some models.

Icons

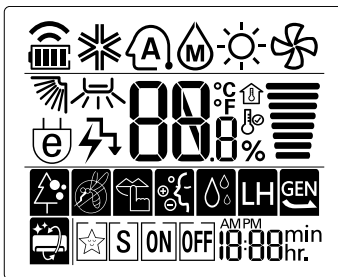

Cooling Mode



Dehumidification Mode



Heating Mode



Fan Mode



Auto Mode



Up-Down Swing



Left-Right Swing



Energy Control Function



Energy Saving Function



Room Temperature



Desired Temperature



Adjusting the Fan Speed



Air Purification Function



Mosquito Away Function



Silent Function



Ion Care Function



Jet Dry Function



Low Heating Function



Auto Clean Function



Gen Mode (Running the appliance on a generator)



Sleep Function



Simple Timer



On Timer



Off Timer

Using Wireless Remote Control

Operating with the Wireless Remote Control

Point the wireless remote control towards the signal receiver at the right side of the appliance to operate it.

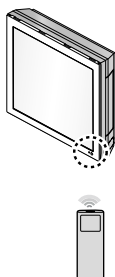

NOTE

- The wireless remote control may operate other electronic devices if it is directed towards them. Make sure to point the wireless remote control towards the appliance signal receiver.
- For proper operation, use a soft cloth to clean the signal transmitter and receiver.
- If a function included on the remote is not supported on the appliance, the appliance may not indicate this by buzzing. Exceptions include the **Adjusting the Left-Right Direction**, **Energy Display** and **Air Purification** functions.

Cooling, Auto, Dehumidification, Heating, Fan Mode

You can change the operating mode when the appliance is turned on.

- 1 Turn the appliance on.

- 2 Press the **MODE** button repeatedly to select the desired mode.

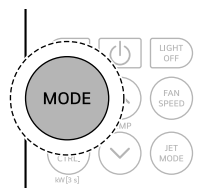

Icon	Description
	Cooling Mode Cool air blows from the air outlets.
	Auto Mode The product adjusts the airflow automatically.
	Dehumidification Mode This function removes moisture in indoor air.
	Heating Mode Warm air blows from the air outlets.
	Fan Mode This function circulates the air without heating or cooling it.

- 3 Press the or button to set the desired temperature.
 - Cooling Mode: Set the temperature from 18 °C (64 °F) to 30 °C (86 °F).
 - Heating Mode: Set the temperature from 16 °C (60 °F) to 30 °C (86 °F).
 - Auto Mode: Set the temperature from 18 °C (64 °F) to 30 °C (86 °F).

22 OPERATION

- Dehumidification, Fan Mode: There is no temperature control.

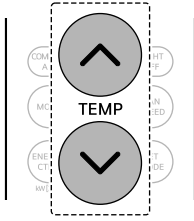

NOTE

- Each press increases or decreases the temperature by 1 °C or 1 °F.

Notes for Each Operation Mode

Cooling Mode

- The cooling mode doesn't work if desired temperature is higher than room temperature.
 - If so, please lower the desired temperature.
 - 5 °C is proper for the difference between room and outside temperature.
 - When setting the desired temperature higher than room temperature, only ventilation wind is blow out instead of cooling wind.

Heating Mode

- The heating mode doesn't work if desired temperature is lower than room temperature.
 - If so, please increase the desired temperature.
 - 5 °C is proper for the difference between room and outside temperature.
 - When setting the desired temperature lower than room temperature, only ventilation wind is blow out instead of cooling wind.
- Heating mode doesn't operate at cooling exclusive model.

Dehumidification Mode

- In rainy season or high humidity climate, it is possible to operate simultaneously dehumidifier and cooling mode to remove humidity effectively.

Auto Mode

- You can use the **FAN SPEED** button during the auto mode.
- You can change other operation mode manually during the auto mode.

Fan Mode

- When running ventilation, compressor of AHU doesn't work.
- Ventilation mode does not release cool wind but general fan.
 - Because it releases the wind that has no temperature difference from the room, it functions to circulate the inside air.
- Natural wind based on chaos logic
 - For a fresher feeling than other fan speeds, press the Indoor Fan Speed Selector and set to chaos mode. In this mode, the wind blows like a natural breeze by automatically changing fan speed based on the chaos logic.
- During Fan Mode
 - The outdoor compressor doesn't work. Have a function to circulate the indoor as it sends out the air that doesn't have much temperature difference with indoor.

Jet Mode

Use this mode to change the room temperature more quickly.

- 1 Turn the appliance on.
- 2 Press the **MODE** button repeatedly to select the desired mode.
 - The **Jet** mode is available with **Cooling, Heating and Dehumidification** modes.

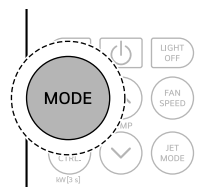

3 Press the **JET MODE** button.

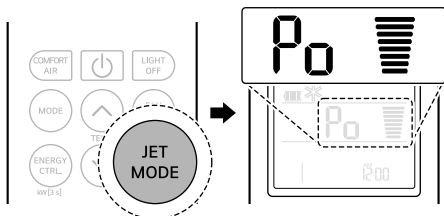

• **Jet Cooling Mode**

Strong cool air blows out for 30 minutes. After 30 minutes, the temperature is maintained at 64 °F (18 °C) by default.

- To change the temperature, press the or button to set the desired temperature.

• **Jet Heating Mode**

Strong warm air blows out for 30 minutes. After 30 minutes, the temperature is maintained at 86 °F (30 °C) by default.

- To change the temperature, press the or button to set the desired temperature.

NOTE

- Press the **JET MODE** or **FAN SPEED** or or button to cancel the **Jet** mode.

Adjusting the Fan Speed

You can adjust the fan speed in 5 steps.

- Press the **FAN SPEED** button repeatedly to select the desired fan speed.

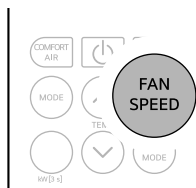

Speed	Wireless Remote Control Icon
High	
Medium - High	
Medium	
Medium - Low	
Low	
Natural Wind	

NOTE

- The Natural Wind fan speed setting adjusts the speed automatically.



Adjusting the Airflow Direction

You can adjust the direction of the airflow vertically or horizontally.

Adjusting the Up-Down Direction

- Press the **SWING (Up-Down Swing)** button repeatedly to adjust airflow direction.



- Select  to adjust the up-down direction of the airflow automatically.

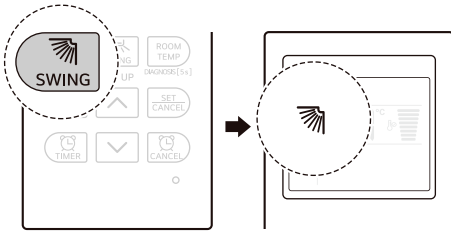

Adjusting the Left-Right Direction

- Press the **SWING (Left-Right Swing)** button repeatedly to adjust airflow direction.



- Select  to adjust the left-right direction of the airflow automatically.

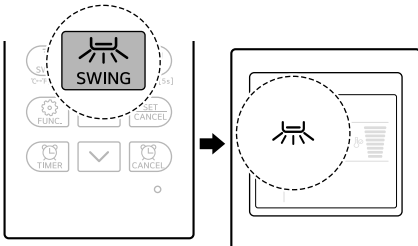

NOTE

- **Adjusting the Left-Right Direction** may not be supported, depending on the model.
- Adjusting the air deflector arbitrarily may cause appliance failure.
- When restarted, the appliance uses the last set airflow direction. The position of the air deflector may not match the icon displayed on the wireless remote control. When this occurs, press the **SWING (Up-Down Swing)** or **SWING (Left-Right Swing)** button to adjust the direction of the airflow again.
- This function may operate differently from the wireless remote control display.

On and Off Timer

You can set the appliance to turn on and off automatically at a desired time.

The **On Timer** and **Off Timer** can be set together.



Setting the On Timer

This function can be set when the appliance is turned on or off.

- 1 Press the **TIMER** button repeatedly.

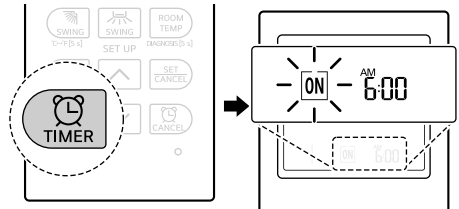
- The icon below flashes at the bottom of the display screen.



- 2 Press the  or  button to set the desired time.

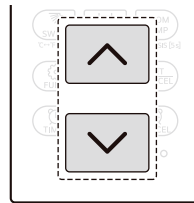

- 3 Press the **SET/CANCEL** button to stop the icon from flashing.

- After setting the timer, the current time and On Timer icon are displayed on the display screen indicating that the desired time is set.

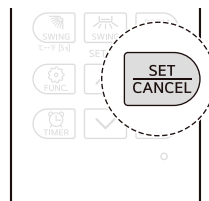

Cancelling the On Timer

- 1 Press the **TIMER** button repeatedly.
 - The icon below flashes at the bottom of the display screen.

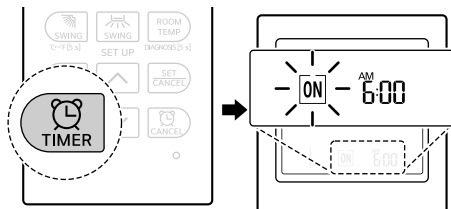

- 2 Press the **SET/CANCEL** button to cancel the setting.

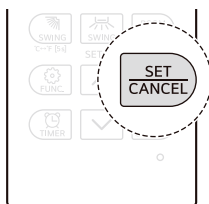

- 2 Press the \wedge or \vee button to set the desired time.

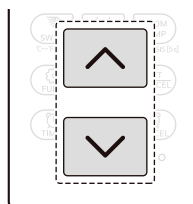

- 3 Press the **SET/CANCEL** button to stop the icon from flashing.
 - After setting the timer, the current time and Off Timer icon are displayed on the display screen indicating that the desired time is set.

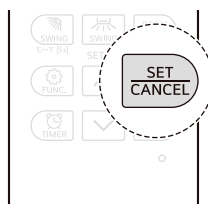

Setting the Off Timer

This function can be set when the appliance is turned on or off.

- 1 Press the **TIMER** button repeatedly.
 - The icon below flashes at the bottom of the display screen.

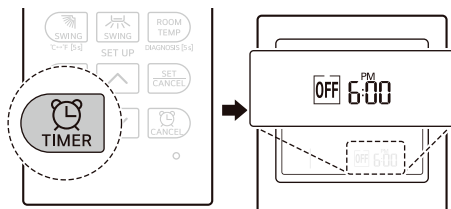

NOTE

- This function is disabled when you set **Simple Timer**.

Cancelling the Off Timer

- 1 Press the **TIMER** button repeatedly.
 - The icon below flashes at the bottom of the display screen.

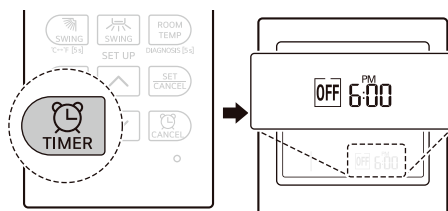

- Press the **SET/CANCEL** button to cancel the setting.

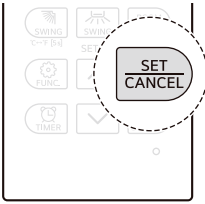

Cancelling the Timer Setting

- Press the **CANCEL** button to cancel all timer settings.

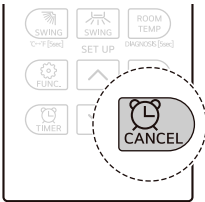

Sleep Function (On Some Models)

You can set the appliance to turn off automatically after a set time. The appliance will automatically change the temperature and fan speed. This function can be set when the appliance is turned on.

- Turn the appliance on.
- Press the **TIMER** button repeatedly.
 - The icon below flashes at the bottom of the display screen.

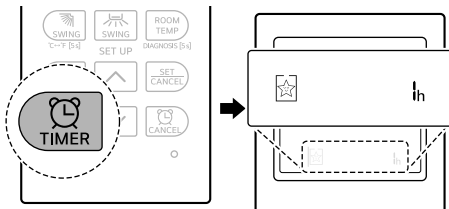

- Press the \uparrow or \downarrow button to set the desired time.
 - The time can be set up to 7 hours.

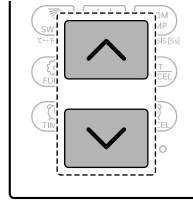

- Press the **SET/CANCEL** button to stop the icon from flashing.
 - The **Sleep** function icon is displayed on the display screen.

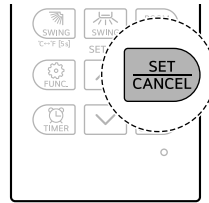

NOTE

- IH is displayed on some indoor units.
- Indoor unit display shows the set time from 1H to 7H for only 5 seconds and then returns to the set temperature.
- In the **Cooling** and **Dehumidification** mode, the temperature increases by 1 °F (1 °C) after 30 minutes and an additional 1 °F (1 °C) after another 30 minutes for a more comfortable sleep. The temperature increases up to 2 °F (2 °C) from the preset temperature.
- Although the remark for fan speed on the display screen may be changed, the fan speed is adjusted automatically.

Light Off Function (On Some Models)

You can set the brightness of the indoor unit display screen.

- Press the **LIGHT OFF** button.

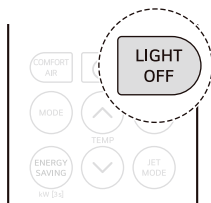

NOTE

- The button turns the display screen on or off.
- If the brightness of an indoor unit's display is set to off, pressing a button on the wireless remote control automatically turns the display on for a while.
- This function may operate differently depending on the model.

Energy Saving Function (On Some Models)

You can minimize power consumption during Cooling and increases the set temperature to the optimal level for a more comfortable environment.

- The temperature automatically returns to 72 °F (22 °C) if the desired temperature is set lower than that. If the temperature is set higher than 72 °F (22 °C), the set temperature remains as set.

- 1 Turn the appliance on.

- 2 Press the **MODE** button repeatedly to select the **Cooling** mode.

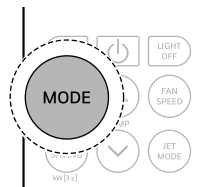

- 3 Press the **ENERGY SAVING** button

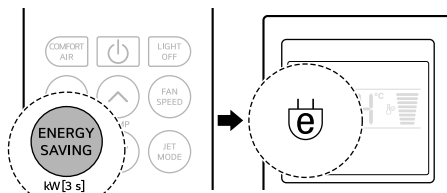

NOTE

- 80, 60, 40 or L (1step), LL (2step) is displayed on some indoor units.
- This function is available with **Cooling** mode.
- Capacity may decrease when the **Energy Saving** function is selected.
- The desired temperature is displayed for about 5 seconds if you press the **FAN SPEED**, \uparrow or \downarrow button.
- The room temperature is displayed for about 5 seconds if you press the **ROOM TEMP (Room Temperature)** button.

Checking Room Temperature

Check the current room temperature.

28 OPERATION

- Press the **ROOM TEMP** button. The current room temperature is briefly displayed on the wireless remote control screen for awhile.

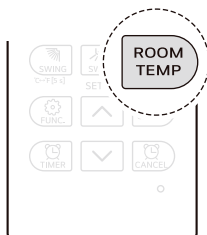

Special Functions Overview

Special Functions



Icon	Description
	<p>Auto Clean Function Reduces moisture generated inside the indoor unit</p>

NOTE

- Some functions may not be supported, depending on the model.
- Some functions may operate differently from the wireless remote control display.

Using Special Functions

Setting and Cancelling Special Functions

Setting the Special Functions

- 1 Turn the appliance on.
- 2 Press the **FUNC. (Function)** button repeatedly to select the desired function.

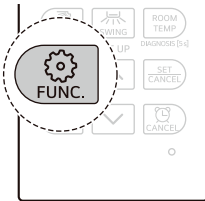

- 3 Press the **SET/CANCEL** button to finish.

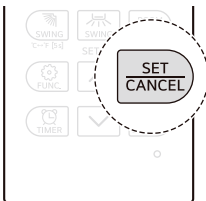

Cancelling the Special Functions

- 1 Press the **FUNC. (Function)** button repeatedly to select the desired function.

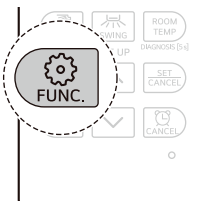

- 2 Press the **SET/CANCEL** button to cancel the function.

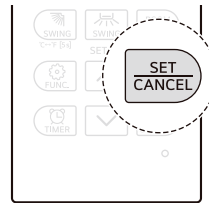

Auto Clean Function (On Some Models)

In the **Cooling** and **Dehumidification** modes, moisture is generated inside the indoor unit. You can reduce that moisture.

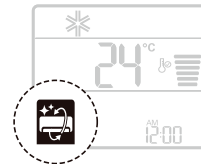

NOTE

- Some functions cannot be used while the **Auto Clean** function is in operation.
- If you turn off the appliance, the fan continues to run for 30 minutes to clean the inside of the indoor unit.
-  is displayed on some indoor units, depending on the model.

MAINTENANCE

Cleaning

Cleaning Interval

⚠ WARNING

- Before cleaning or performing maintenance, disconnect the power supply and wait until the fan stops.

Cleaning the Appliance

If the appliance will not be used for an extended period of time, dry the appliance to maintain it in the best condition. Clean the appliance regularly to maintain optimal performance and to prevent possible breakdown.

- Dry the appliance in **Fan** mode for 3 to 4 hours and disconnect the power. There may be internal damage if moisture is left in the appliance's components.
- Before using the appliance again, dry the inner components of the appliance in **Fan** mode for 3 to 4 hours. This will help to reduce the odor generated from moisture.

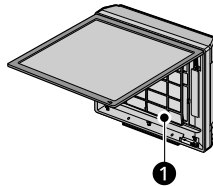

① Air Filter

NOTE

- The feature may vary depending on the model type.

Type	Description	Interval
Indoor unit	Clean the surface of the indoor unit using a soft, dry cloth.	Regularly
	Have a professional clean the condensate drain pan.	Once a year
	Have a professional clean the condensate drain pipe.	Every 4 months
	Replace the wireless remote control batteries.	Once a year

32 MAINTENANCE

Type	Description	Interval
Outdoor unit	Have a professional clean the heat exchanger coils and the panel vents. (Consult with technician.)	Once a year
	Have a professional clean the fan.	Once a year
	Have a professional clean the condensate drain pan.	Once a year
	Have a professional verify that all the fan assembly is firmly tightened.	Once a year
	Clean the electrical components with compressed air.	Once a year

Cleaning the Filter

Type	Description	Interval
Air filter	Clean with a vacuum or hand wash.	2 weeks

NOTE

- Never use water that is hotter than 104 °F (40 °C) when you clean the filters. Doing so may cause deformation or discoloration.
 - Never use volatile substances when you clean the filters. Doing so may damage the surface of the appliance.
-

Cleaning the Air Filter

NOTE

- Do not bend the air filter, as it may break.
- Assemble the air filter properly to prevent dust and other substances from entering the product.

1 Turn off the power to the appliance.

2 Pull out the upper section of the front panel and lift it up to release the tab.

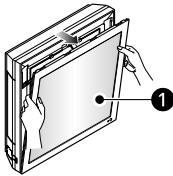

1 Front panel

3 Once the tab is released, lift the front panel up from the bottom and remove the filter.

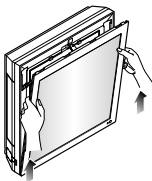

4 Clean the air filter with a vacuum cleaner or wash it with lukewarm water and a mild detergent.



5 Dry the filter in the shade.

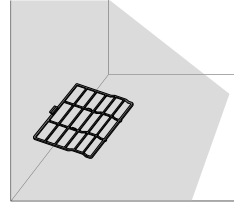

6 Reassemble the air filter **1**.

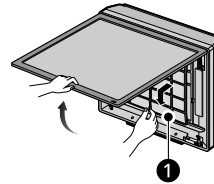

7 Close the front panel until the tab **3** locks into place.

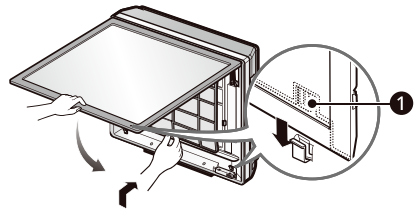

Replace Picture or Photograph

- 1 Turn off the power and pull the top part of the front panel forward.

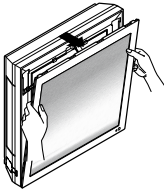

- 2 Pull out both links on the lower part of the front panel, as shown.

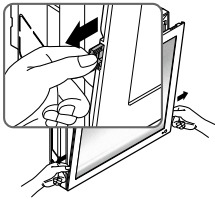

- 3 Push the top part of the panel closed and pull the bottom part of the panel forward until it is secured in place.

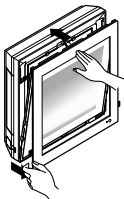

- 4 Remove the picture.

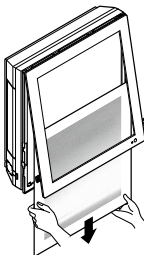

- 5 Turn the picture and mat face down and remove the protective tape on the mat.

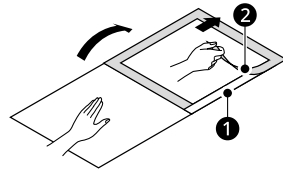

- 6 Center your picture or photo on the back of the removed photo. (Recommended picture/photo size: 450 mm x 450 mm)

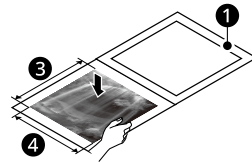

- 7 Flip the mat over, align it with the edges of the backing picture, and press down on the mat until it sticks to the backing picture.

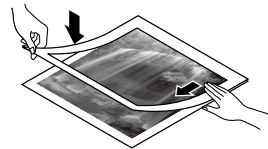

- 8 Slide the art under the tabs at the side of the front panel as shown until it is securely in place. Press lightly on the front panel to close it.

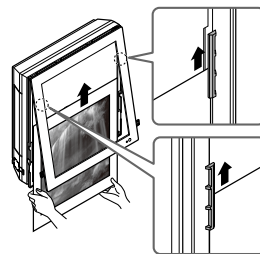

- 9 Reassemble the links on either side of the lower front panel to lock it in place. You can now turn on the product.

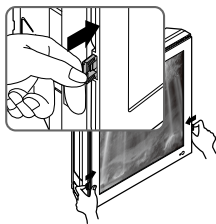

- 3 Check that the ground wire is connected correctly.
- The ground wire may be connected to the side of the indoor unit.

NOTE

- In case a mat is not used, recommended size of a photo/picture: 522 mm X 522 mm
- When powering on after replacing filter and picture, the front panel should not interfere.

Tips for Maintenance

Before Long Periods of Disuse

- 1 Operate the air conditioner in the **Fan mode** for 2 to 3 hours.
 - This will dry out the internal mechanisms.
- 2 Turn off the appliance.
- 3 Turn off the breaker.

After Long Periods of Disuse

- 1 Clean the air filter and install it in the indoor unit.
- 2 Check that the air inlet and outlet of the indoor/outdoor unit are not blocked.

TROUBLESHOOTING

Before Calling for Service

Please check the following before you contact the service center. If the problem persists, contact your local service center.

NOTE

- Some functions may not be supported, depending on the model.

Self-Diagnosis Function

This appliance has a built-in **Self-Diagnosis** function. If an error occurs, the LED of the indoor unit will flash in 2-second intervals. If this occurs, contact your local dealer or service centre.

Operation

Symptoms	Possible Cause & Solution
The appliance does not work normally.	Burning smell and strange sounds are coming from the appliance. <ul style="list-style-type: none"> • Turn off the appliance, switch off or disconnect the power supply, and contact a service centre.
	Water leaks from the indoor unit even when the humidity level is low. <ul style="list-style-type: none"> • Turn off the appliance, switch off or disconnect the power supply, and contact a service centre.
	The power cable is damaged or it is generating excessive heat. <ul style="list-style-type: none"> • Turn off the appliance, switch off or disconnect the power supply, and contact a service centre.
	A switch, a circuit breaker (safety, ground) or a fuse is not operating properly. Has the fuse blown or has the circuit breaker been tripped? <ul style="list-style-type: none"> • Turn off the appliance, switch off or disconnect the power supply, and contact a service centre.
	The appliance generates an error code from its self-diagnosis. <ul style="list-style-type: none"> • Turn off the appliance, switch off or disconnect the power supply, and contact a service centre.
The fan speed cannot be adjusted.	The Jet mode or Auto Operation mode is selected. <ul style="list-style-type: none"> • In some operating modes, you cannot adjust the fan speed. Select an operating mode in which you can adjust the fan speed.

Symptoms	Possible Cause & Solution
The fan speed cannot be adjusted.	<p>The airflow generated by the air conditioner may be automatically adjusted during operation.</p> <ul style="list-style-type: none"> When the air conditioner reaches the set temperature, it reduces the airflow rate to avoid generating cool airflow when heating, or to minimize energy consumption and indoor humidity change when cooling.
The temperature cannot be adjusted.	<p>The Fan mode or Jet mode is selected.</p> <ul style="list-style-type: none"> In some operating modes, you cannot adjust the temperature. Select an operating mode in which you can adjust the temperature.
The appliance stops during operation.	<p>The appliance is suddenly turned off.</p> <ul style="list-style-type: none"> The Off Timer function may have timed out, which turns the appliance off. Check the timer settings.
	<p>Have you made a mistake in timer operation?</p> <ul style="list-style-type: none"> Set the timer correctly.
	<p>A power failure has occurred during operation.</p> <ul style="list-style-type: none"> Wait for the power to come back on. If you have the Auto Restart function enabled, your appliance will resume its last operation several minutes after power is restored.
The appliance does not work.	<p>A fuse blew or the power supply is blocked.</p> <ul style="list-style-type: none"> Replace the fuse or check if the circuit breaker has tripped.
	<p>The appliance is unplugged.</p> <ul style="list-style-type: none"> Check whether the power cord is plugged into the outlet or the power isolators are switched on.
	<p>A power failure has occurred.</p> <ul style="list-style-type: none"> Turn off the appliance when a power failure occurs. When the power is restored, wait 3 minutes, and then turn on the appliance.
	<p>The voltage is too high or too low.</p> <ul style="list-style-type: none"> Check if the circuit breaker has tripped.
	<p>The appliance was turned off automatically at a preset time.</p> <ul style="list-style-type: none"> Turn the appliance on.
	<p>The battery orientation in the wireless remote control is incorrect.</p> <ul style="list-style-type: none"> Make sure that the batteries are inserted correctly in your wireless remote control. If the batteries are placed correctly, but the appliance still does not operate, replace the batteries and try again.
	<p>Are the indoor unit's air inlet or outlet vents obstructed?</p> <ul style="list-style-type: none"> Remove the obstacles.

Symptoms	Possible Cause & Solution
<p>The appliance does not emit cool air.</p>	<p>Air is not circulating properly.</p> <ul style="list-style-type: none"> • Make sure that there are no curtains, blinds, or pieces of furniture blocking the front of the appliance.
	<p>The air filter is dirty.</p> <ul style="list-style-type: none"> • Clean the air filter once every 2 weeks. • See “Cleaning the Air Filter” for more information.
	<p>The room temperature is too high.</p> <ul style="list-style-type: none"> • In summer, cooling the indoor air fully may take some time. In this case, select the Jet mode to cool the indoor air quickly.
	<p>The room may have been very hot when the room air conditioner was first turned on.</p> <ul style="list-style-type: none"> • Allow time for it to cool down.
	<p>Cold air is escaping from the room.</p> <ul style="list-style-type: none"> • Make sure that no cold air is escaping through the ventilation points in the room.
	<p>The desired temperature is higher than the current temperature.</p> <ul style="list-style-type: none"> • Set the desired temperature to a level lower than the current temperature.
	<p>There is a heating source nearby.</p> <ul style="list-style-type: none"> • Avoid using heat generators like electric ovens or gas burners while the air conditioner is in operation.
	<p>Fan mode is selected.</p> <ul style="list-style-type: none"> • During Fan mode, air blows from the appliance without cooling or heating the indoor air. • Switch the operating mode to a cooling operation.
	<p>Outside temperature is too high.</p> <ul style="list-style-type: none"> • The cooling effect may not be sufficient.
<p>The appliance does not emit warm air.</p>	<p>When the Heating mode starts, the vane is almost closed, and no air comes out, even though the outdoor unit is operating.</p> <ul style="list-style-type: none"> • This is normal. Please wait until the appliance has generated enough warm air to blow through the indoor unit.
	<p>The outdoor unit is in Defrosting mode.</p> <ul style="list-style-type: none"> • In Heating mode, ice and frost is built up on the coils when the outside temperature falls. The Defrosting mode reduces a layer of frost on the coil, and it should finish in approximately 15 minutes.
	<p>Outside temperature is too low.</p> <ul style="list-style-type: none"> • The heating effect may not be sufficient.

Symptoms	Possible Cause & Solution
The air conditioner changes generated airflow during operation.	<p>When the appliance reaches the desired temperature, the airflow rate reduces in order to avoid generating cool airflow during heating, or to minimize energy consumption and indoor humidity change during cooling.</p> <ul style="list-style-type: none"> This symptom is normal.
It seems that condensation is leaking from the air conditioner.	<p>Condensation occurs when the airflow from the air conditioner cools the warm room air.</p> <ul style="list-style-type: none"> This symptom is normal.

Performance

Symptoms	Possible Cause & Solution
The indoor unit is still operating even when the appliance has been turned off.	<p>The Auto Clean function is being operated.</p> <ul style="list-style-type: none"> Allow the Auto Clean function to continue since it reduces any remaining moisture inside the indoor unit. If you do not want this function, you can turn the indoor unit off.
The air outlet on the indoor unit is discharging mist.	<p>The cooled air from the appliance makes mist.</p> <ul style="list-style-type: none"> When the room temperature decreases, this phenomenon will disappear.
Water leaks from the outdoor unit.	<p>In the heating operations, condensed water drops from the heat exchanger.</p> <ul style="list-style-type: none"> Install a drain hose under the base pan. Contact the installer.
There is noise or vibration.	<p>A clicking sound can be heard when the appliance starts or stops due to movement of the reversing valve.</p> <p>Creaking sound: The plastic parts of the indoor unit creak when they shrink or expand due to sudden temperature changes.</p> <ul style="list-style-type: none"> Noise is normal during or after operation. It is not a sign of malfunction.
	<p>Flowing sound: This is the flow of refrigerant through the appliance.</p> <p>Blowing sound: This sound generates when compressed air is released into the atmosphere.</p> <p>This is the sound of the dehumidifying water being processed inside the air conditioning unit.</p> <ul style="list-style-type: none"> These are normal symptoms. The noise will stop.
Crack sound is heard.	<p>This sound is generated by the expansion or constriction of the front panel, etc. due to changes of temperature.</p> <ul style="list-style-type: none"> These are normal symptoms. The noise will stop.

Symptoms	Possible Cause & Solution
The indoor unit gives off an odour.	Odours (such as cigarette smoke) may be absorbed into the indoor unit and discharged with airflow. <ul style="list-style-type: none"> If the smell does not disappear, you need to wash the filter. If this does not work, contact the service centre to clean your heat exchanger.
	Check that this is not a damp smell exuded by the walls, carpet, furniture or cloth items in the room. <ul style="list-style-type: none"> If the smell comes out from walls, carpet, furniture or cloth item, clean it.
Remote control display is faint, or no display at all.	Are the batteries depleted? <ul style="list-style-type: none"> Replace the batteries with a new one.
	Are the batteries inserted in the opposite + and - directions? <ul style="list-style-type: none"> Make sure that the + and - terminals of the batteries are oriented correctly.

Calling for Service

Situations in which Calling for Service is Necessary

If the appliance is in one of the following situations, please call the service.

- Anything abnormal, such as a burning smell, loud noises, etc., occur;
 - Turn off the appliance and circuit breaker.
 - Never try to repair or restart the appliance yourself.
- Main power cord is too hot or damaged.
- Error code is generated by self diagnosis.
- Water leaks from the appliance even if the humidity is low.
- Any switch, circuit breaker(safety, earth) or fuse fails to work properly.

NOTE

- The user is responsible for routine checks and cleaning to avoid poor appliance performance.
 - In cases involving unusual or special situations and circumstances servicing must be carried out only by trained service personnel.
-



Manufacturer :

LG Electronics Inc.

84, Wanam-ro, Seongsan-gu, Changwon-si, Gyeongsangnam-do, KOREA

UK Importer: LG Electronics U.K. Ltd

Velocity 2, Brooklands Drive, Weybridge, KT13 0SL

Eco design requirement

• The information for Eco design is available on the following free access website.

<https://www.lg.com/global/support/cedoc/cedoc>