

UP81\*

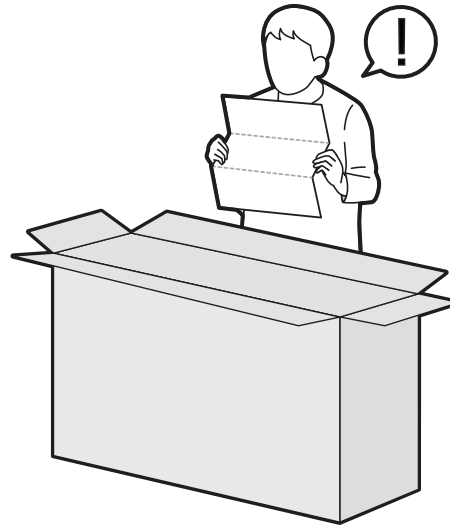

**1**  
55UP81\*

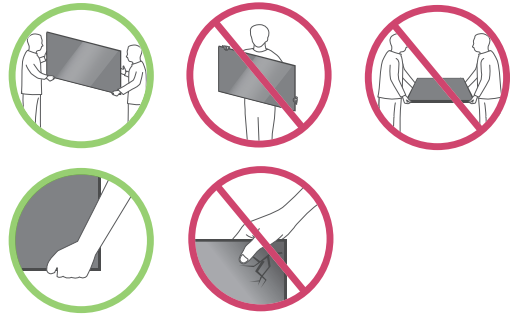
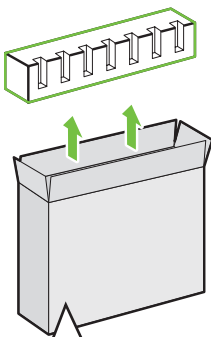

**2**

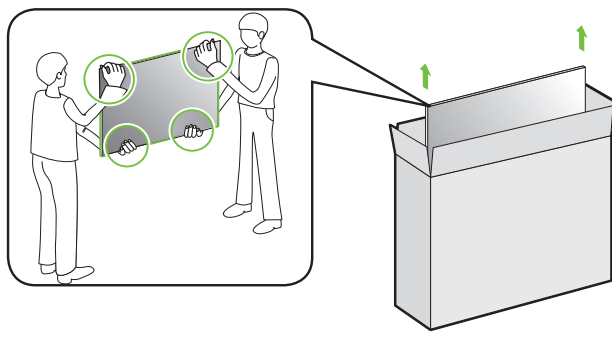

**3**

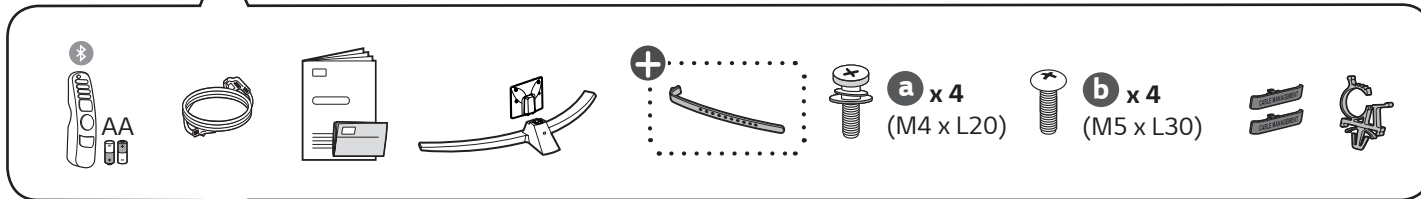
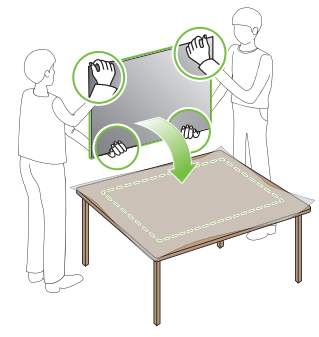

**1**  
65UP81\*

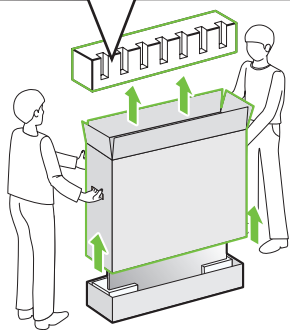

**2**

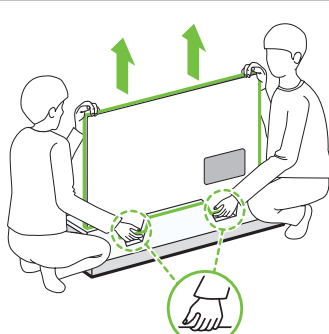

**3**

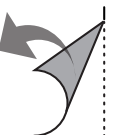
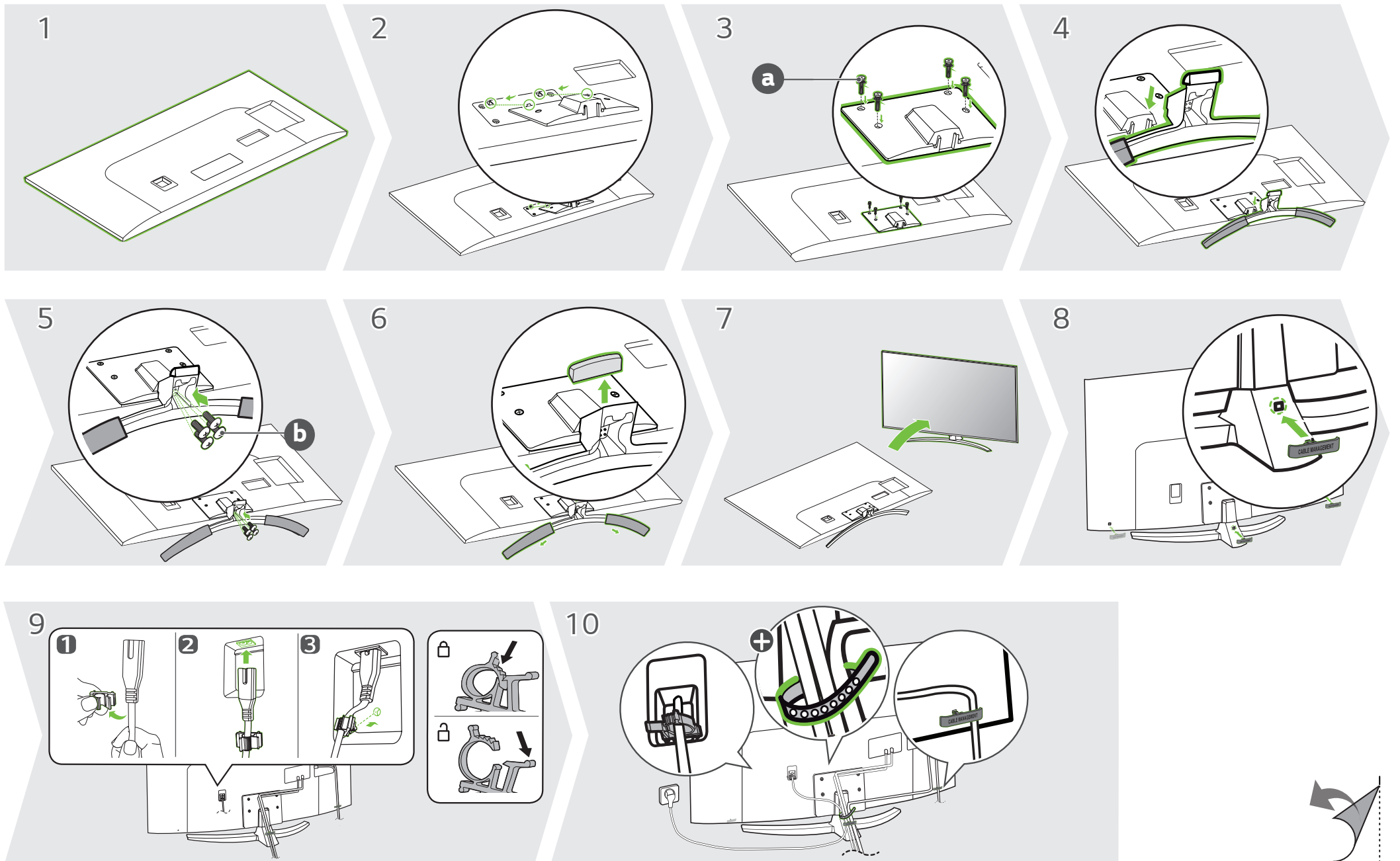
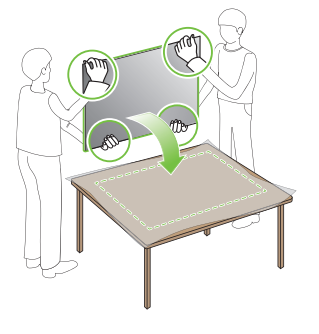

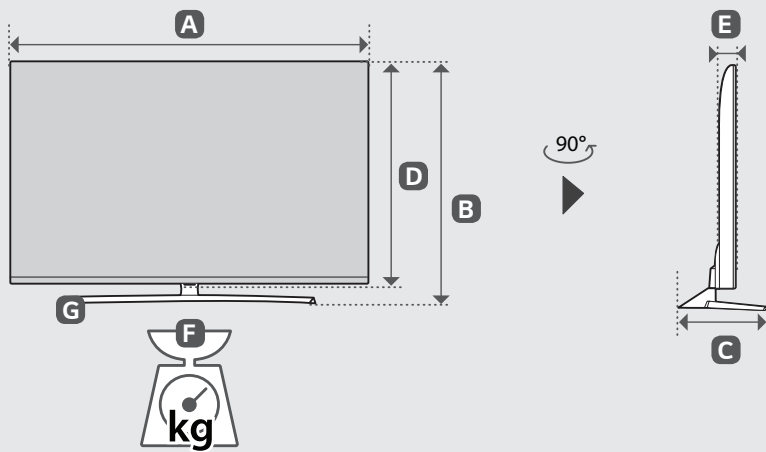
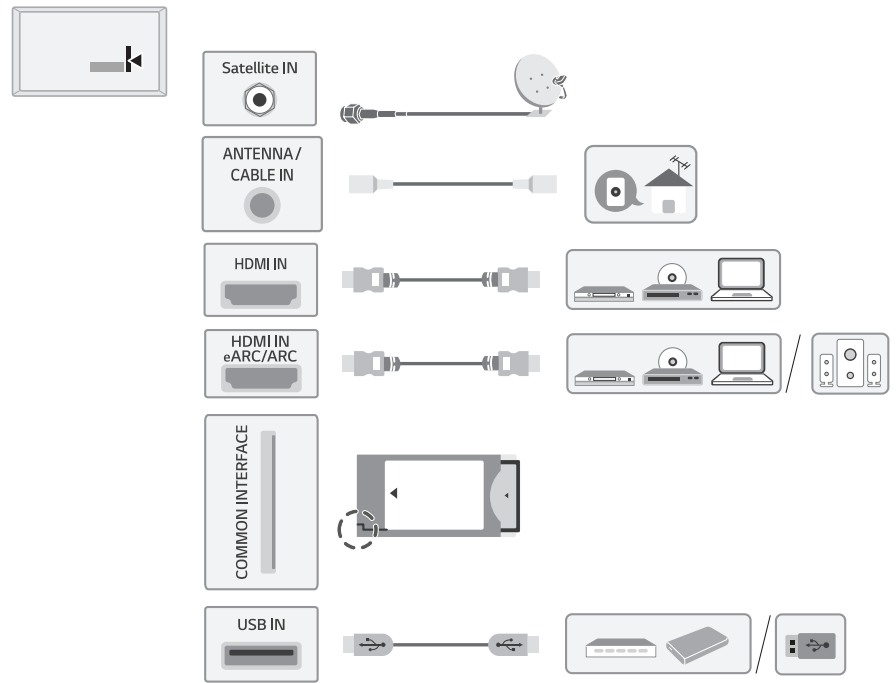
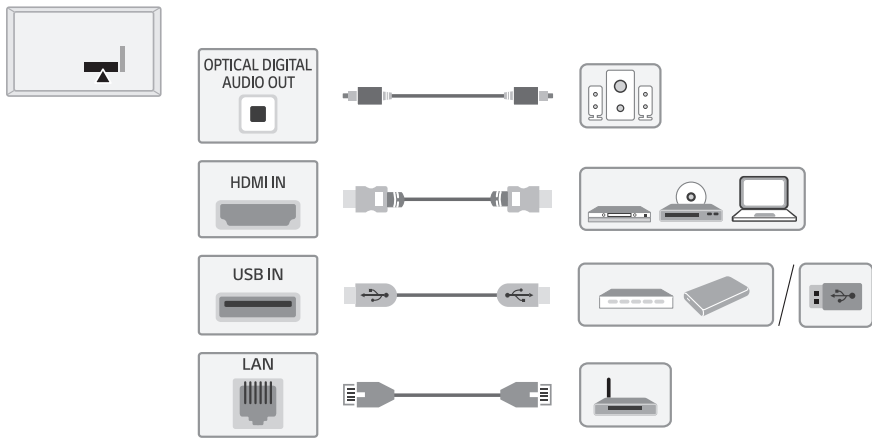

|                   | A    | B   | C   | D                         | E    | F    | F-G  |
|-------------------|------|-----|-----|---------------------------|------|------|------|
|                   | (mm) |     |     | (kg)                      |      |      |      |
| 55UP81003LA       | 1235 | 787 | 260 | 715                       | 57.5 | 15.4 | 14.0 |
| 55UP81006LA       |      |     |     |                           |      |      |      |
| 55UP81009LA       |      |     |     |                           |      |      |      |
| 55UP81003LR       |      |     |     |                           |      |      |      |
| 55UP81006LR       |      |     |     |                           |      |      |      |
| 55UP81009LR       |      |     |     |                           |      |      |      |
| 65UP81003LA       | 1454 | 909 | 340 | 838                       | 57.7 | 22.9 | 21.5 |
| 65UP81006LA       |      |     |     |                           |      |      |      |
| 65UP81009LA       |      |     |     |                           |      |      |      |
| 65UP81003LR       |      |     |     |                           |      |      |      |
| 65UP81006LR       |      |     |     |                           |      |      |      |
| 65UP81009LR       |      |     |     |                           |      |      |      |
| Power requirement |      |     |     | AC 100-240 V - 50 / 60 Hz |      |      |      |



- English** • Read **Safety and Reference**.
- Русский** • Прочтите **Руководство по технике безопасности**.
- Українська** • Прочитайте **"Правила безпеки та довідкова інформація"**.
- Қазақша** • **Қауіпсіздік нұсқаулығын** оқыңыз.
- O'zbekcha** • **Xavfsizlik bo'yicha ko'rsatmalar va havolalar**ni o'qib chiqing.
- Монгол** • **Аюулгүй ажиллагааны зааварчилгааг** уншина уу.

⊕ : Depending on model / В зависимости от модели / Залежно від моделі / Үлгіге байланысты / Rusumiga qarab / Загвараас хамаарна