

OLED55CX*
OLED65CX*
OLED77CX*

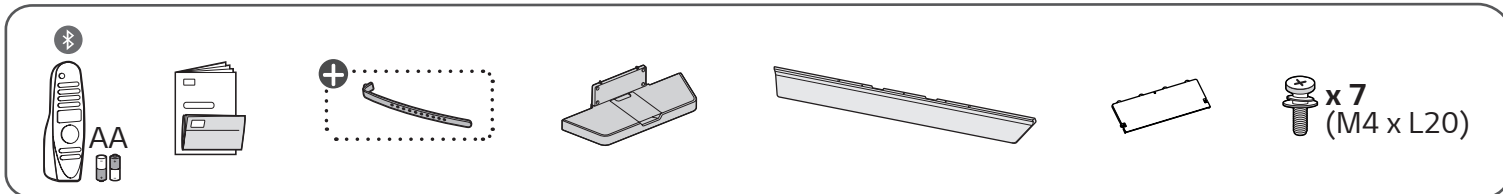

1-A OLED55/65CX*

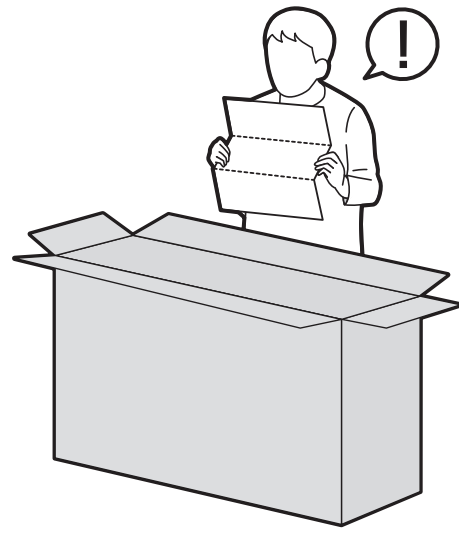
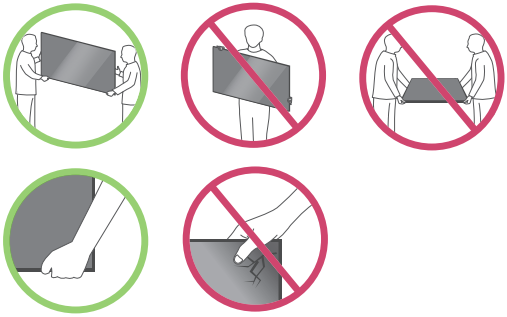
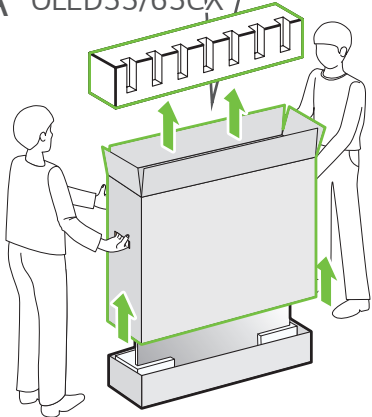

1-B OLED77CX*

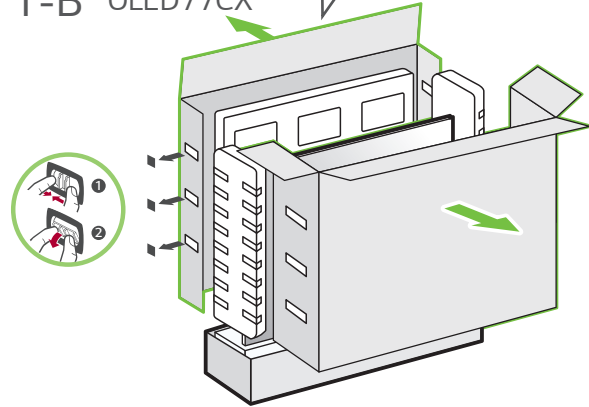

2

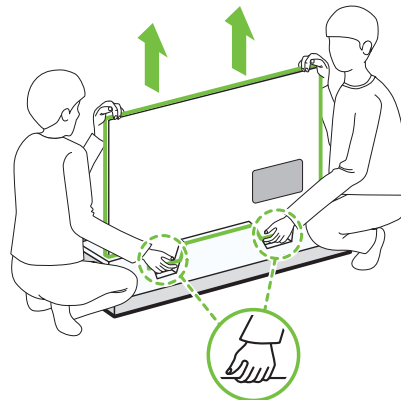

3

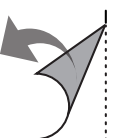
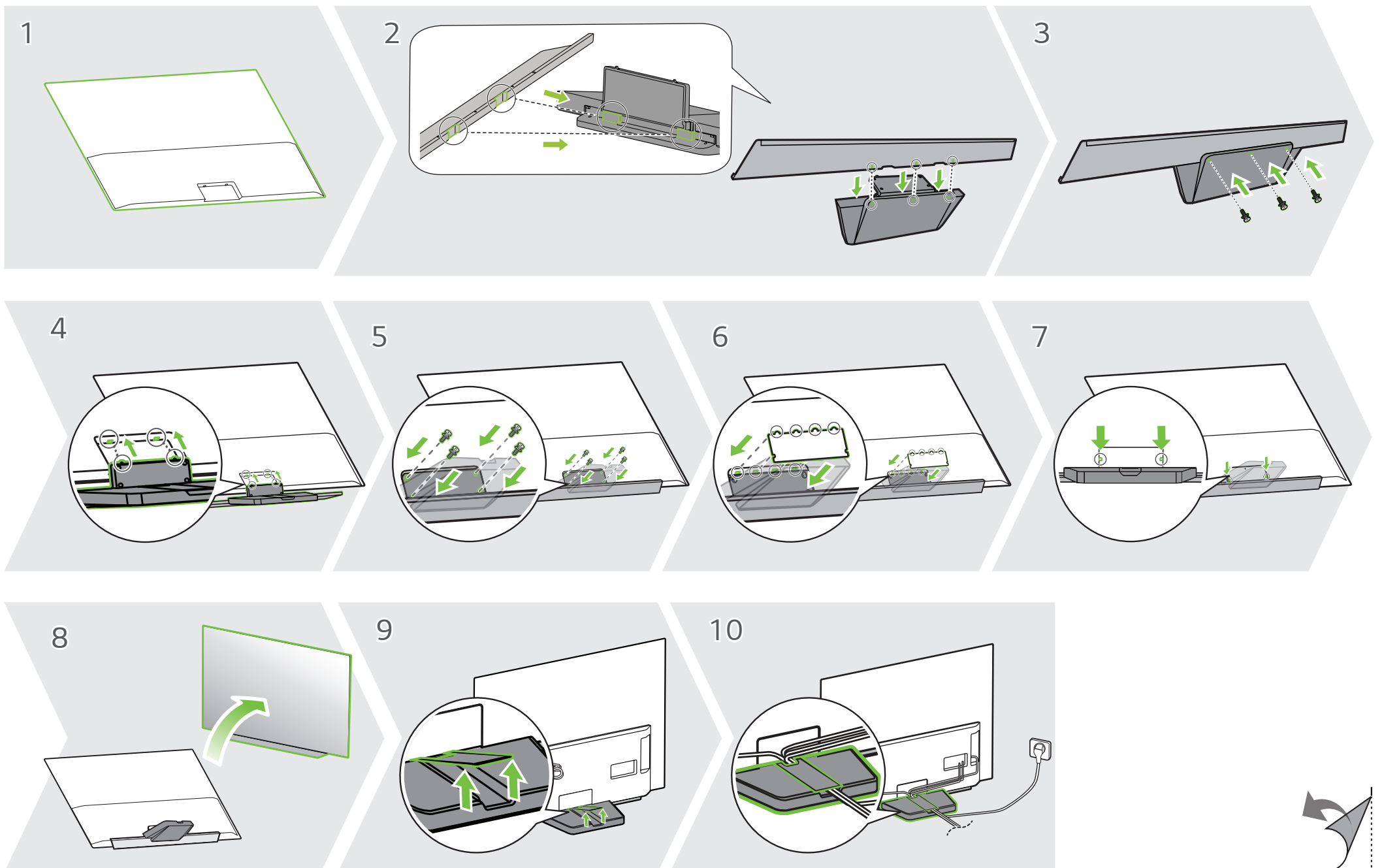
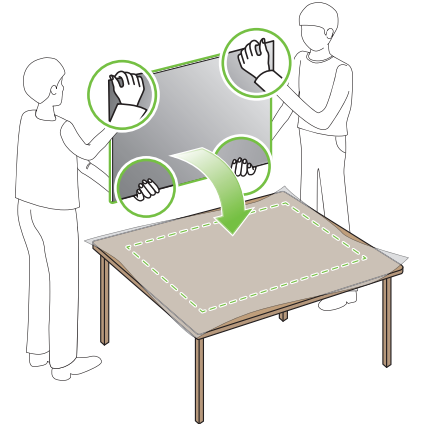

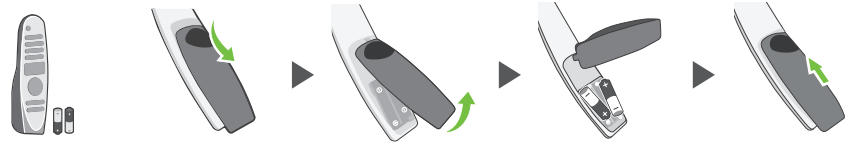
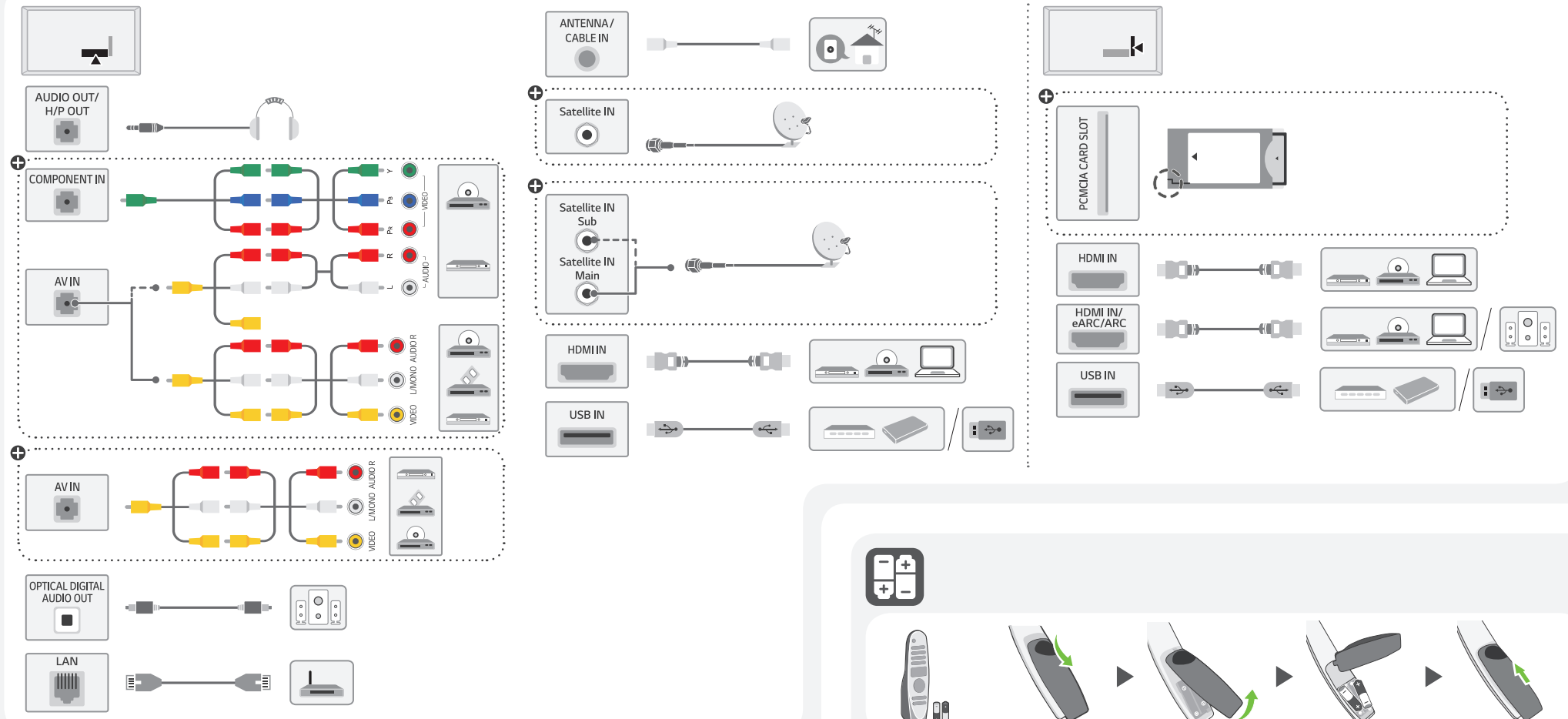

OLED55/65CX*



OLED77CX*

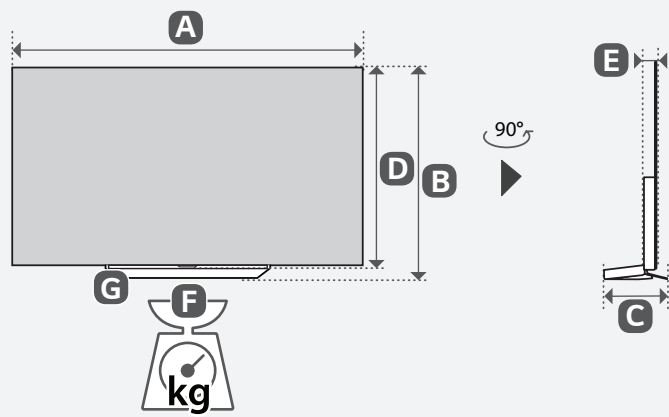
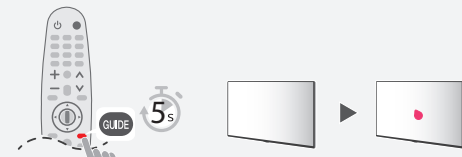

	A	B	C	D	E	F	F-G
	(mm)					(kg)	
OLED55CX3LA							
OLED55CX6LA							
OLED55CX9LA	1228	738	251	706	46.9	23.0	18.9
OLED55CXRLA							
OLED55CX5LB							
OLED55CX8LB							
OLED65CX3LA							
OLED65CX6LA							
OLED65CX9LA	1449	862	251	830	46.9	32.6	24.0
OLED65CXRLA							
OLED65CX5LB							
OLED65CX8LB							
OLED77CX3LA							
OLED77CX6LA							
OLED77CX9LA	1723	1023	269	993	55.3	35.9	26.7
OLED77CXRLA							
Power requirement / Güç gereksinimi / Alimentation / متطلبات الطاقة	AC 100-240 V ~ 50 / 60 Hz						



- English** • Read **Safety and Reference**.
- Türkçe** • **Güvenlik ve Referans** bölümünü okuyun.
- Français** • Lire le document **Sécurité et référence**.

العربية • قراءة الأمان والمرجع.

⊕ : Depending on model / Modele bağlı olarak değişiklik gösterebilir / Selon le modèle / حسب الطراز