

LG **xboom** Grab

Portable Bluetooth Speaker

Owner's Manual

Please read this manual carefully before operating your set and retain it for future reference.

GRAB



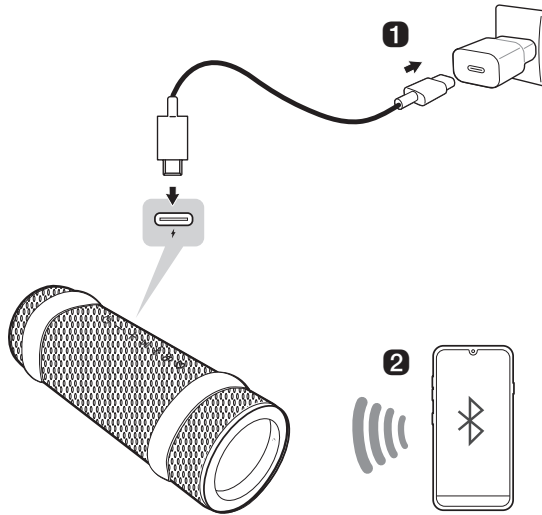

Portable Bluetooth Speaker Quick Guide

Connecting and Using the Speaker



1 Charge the speaker before using it and connect the speaker to an AC adapter (not supplied).

2 Connect the speaker to a smartphone via Bluetooth (→ See “Connecting Smartphone to the Speaker via Bluetooth” on page 14.)

- 1 Press the **Power**  button on the speaker to turn it on. The lighting Indicator blinks.
- 2 Press the **Settings**  button on the smartphone and select **Bluetooth**. Turn on the **Bluetooth** function. (**Off**  > **On** )
- 3 Find “xboom Grab” on the device list on the smartphone and connect to it. Once the smartphone is connected via **Bluetooth**, the lighting Indicator will turn on.
- 4 On the smartphone, play a music of your choice.

3 Connecting the LG ThinQ app (→ See “Installing app” on page 21.)

- 1 Find the **LG ThinQ app** on the Google Play or App Store and install it on your smartphone.
- 2 Run the **LG ThinQ app** and use more features. (EQ, Party Link, Lighting, Sleep Timer, Setting etc.)

Table of Contents

Portable Bluetooth Speaker Quick Guide

- 2 Connecting and Using the Speaker

Exploring the Product

- 5 Top
- 7 Back
- 8 Carrying the unit

Charge

- 9 Charging the Battery
- 11 Checking Battery Status

Connecting to Bluetooth

- 14 Connecting Smartphone to the Speaker via Bluetooth
- 18 Connecting Two Bluetooth Devices to the Speaker
- 19 Talking on the Phone Hands-free
- 20 Using Voice command

Connecting to the LG ThinQ app

- 21 Installing app
- 22 Using MY function
- 23 Using the Party Link
- 27 Listening Auracast™ broadcast

Additional Functions

- 28 Force the Speaker power off
- 28 Initializing the speaker
- 29 Using Auto Power Management
- 30 Using Power On via Bluetooth
- 30 Voice feedback function

Safety Precautions

- 31 Safety and Regulatory
- 34 Prevention of product misuse

Before Reporting Product Malfunction

- 38 Troubleshooting

Appendix

- 39 Specifications
- 40 Registered Trademarks and Licenses
- 40 Open Source Software Notice Information
- 41 Handling the Product

Exploring the Product

Top

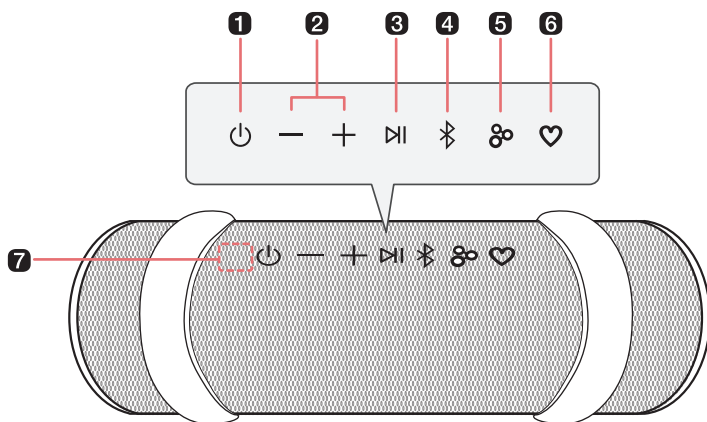

1 Power

Turns the speaker on or off.

2 Volume

This adjusts the speaker volume.

3 Play/Pause

While **Bluetooth** is connected, press the button to operate the **Bluetooth** device.

- Play/Pause: Press the button.
- Moving to the next music: Press the button twice quickly.
- Moving to the previous music: Press the button three times quickly.
- Using the Hands-Free function: Press the button in **Bluetooth** function when you receive a call from a device connected via **Bluetooth**. (→ See “Talking on the Phone Hands-free” on page 19.)
- Using the Voice command: Press and hold the button for 2 seconds. (→ See “Using Voice command” on page 20.)

4 Bluetooth

You can change the **Bluetooth** settings.

- Connecting an additional smartphone: Press the button. (→ See “Connecting Two Bluetooth Devices to the Speaker” on page 18.)
-

5 Party Link

- Stereo mode: Press the button twice quickly. (→ See “Stereo mode” on page 23.)
 - Only the same models can be connected.
 - Multi mode: Press the button. (→ See “Multi mode” on page 24.)
 - **Party Link** is only available among Auracast™-supported models from LG.
-

6 MY

- Press the button to use the **MY** functions. (→ See “Using MY function” on page 22.) Before using **MY** functions, set up in the **LG ThinQ app**.
 - Press the button twice to use Space Calibration. It selects the optimal sound settings to suit your content.
 - If the **MY** button setting in the **LG ThinQ app** is set to FYI.AI, it works as follows:
 - Press the button to launch the FYI.AI app.
 - Press and hold the button to input voice. Voice input is completed when the button is released.
-

7 Microphone

You can use the voice command and Hands-Free function while the speaker is connected to **Bluetooth**.

- Do not cover the microphone part with the strap when the device is in operation.
-

CAUTION

Please note that when using the Space Calibration feature, the sound may suddenly become louder during the stage of optimizing sound quality.

Note

Press and hold the **Party Link**  button on one of the connected speakers for 2 seconds to cancel Stereo mode or Multi mode.

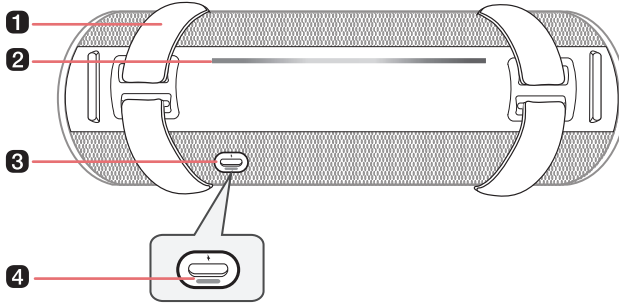



1 Strap

You can use it when carrying the product. (→ See "Carrying the unit" on page 8.)

2 Lighting Indicator

You can check the status of this speaker (battery charging level and battery status, **Bluetooth** connection status, speaker volume, Multi mode, Stereo mode and selected EQ etc.)

- To turn off the speaker's lighting, open the **LG ThinQ App** and navigate to the lighting bar to control the lighting settings.
- Manual Control: Press the "**Volume**  button and the "**MY** 

3 DC IN

Plug in a USB (C-Type) cable to charge the speaker battery.

4 Dot LED

You can check the status of this speaker. (battery charging level and battery status, Multi mode, Stereo mode) (→ See "Checking Battery Status" on page 11.)

- Press and hold the **Power**  button for 2 seconds to check the battery level while the power or the speaker is on.

⚠ CAUTION

Be careful not to drop the speaker. Mechanical shock may cause deterioration of water-resistant and dust-resistant performance.

Carrying the unit

To use for handheld

1 Please lift the strap on the both sides of the unit up.



2 Pull the outer strap all the way up. Then you can easily carry it by hand and use it.

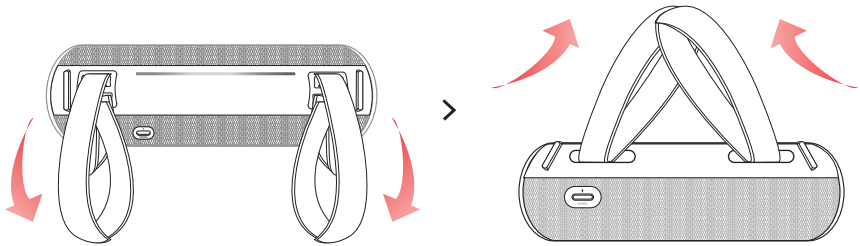

Charge

| Charging the Battery

The speaker has a built-in battery. Make sure to charge the battery sufficiently before use.

- 1 Connect the USB cable to **DC IN** port of the speaker.
- 2 Connect the supplied USB cable to the AC adapter (not supplied).
- 3 Plug the AC adapter into an AC outlet.

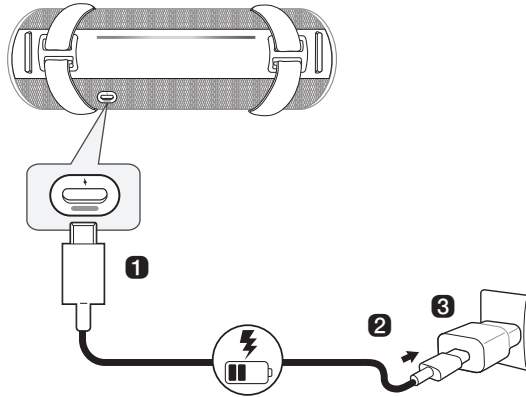

✔ Note

- It takes about 3 hours to fully charge the speaker. The charging time may differ depending on the battery status or the speaker operation status.
 - Once the battery is fully charged, you can use the speaker for up to 20 hours.
 - Operation time may vary depending on the battery or operation status.
-



⚠ CAUTION

- AC adapter is not supplied. It is recommended that you use the 5 V AC adapter (more than 2 A) with this speaker. If you do not use the recommended adapter, charging time may differ.
 - Do not expose the speaker to liquids while charging or without disconnecting the cables. If exposed to liquid, do not charge the speaker until it is completely dry and clean.
 - Charging while wet may damage the speaker.
 - If exposed to chemicals and salt from a pool or ocean, dry and clean thoroughly.
 - Otherwise, it may cause a malfunction.
-

Checking Battery Status

Charging Status

Once the battery charging starts, the Dot LED indicates the charging status.

Dot LED	LED Status / Battery Status
	Turns on green for 15 seconds. / Charging is complete.
	Turns on in green. / The battery level is above 70 %. / Charging is in progress.
	Turns on in amber. / The battery level is between 20-70 %. / Charging is in progress.
	Turns on in red. / The battery level is below 20 %. / Charging is in progress.

✔ Note

- Playing tracks while charging may lengthen the charging time.
- When the speaker's battery is fully charged with the power off, the Dot LED lights up green for 15 seconds and then off.
- When connecting to Party Link, the Party Link connection status indicator takes precedence over the battery indicator.
- If you charge the speaker while it is powered off, the Dot LED may light up late depending on the adapter.

⚠ CAUTION





- Charge the battery at an ambient temperature of 5 °C to 35 °C. When the battery is out of the chargeable temperature range, the Dot LED alternates between red and amber, and charging stops.
- If you charge while using the speaker, the battery temperature may become high and charging may stop. In this case, turn off the power and charge the speaker.

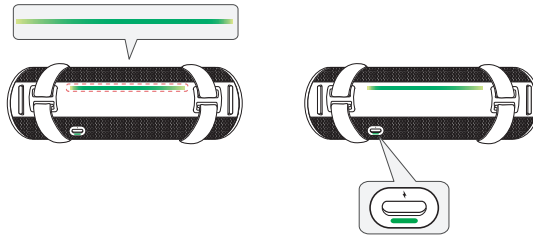



Use Status

When you turn on the speaker or press and hold the **Power**  button for 2 seconds, the Dot LED and the lighting Indicator are turned on for 3 seconds according to the battery status.



When the power cable is not connected (Battery mode)





Lighting Indicator	Indicator Status / Battery Status
	Turns on green for 3 seconds. / The battery level is above 70 %.
	Turns on amber for 3 seconds. / The battery level is between 20-70 %.
	Turns on red for 3 seconds. You can hear a notification sound once. / The battery level is below 20 %.
	Turns on in light red for 3 seconds. You can hear a notification sound once. / The battery level is below 10 %, and the battery needs to be charged.





Dot LED	LED Status / Battery Status
	Turns on green for 3 seconds. / The battery level is above 70 %.
	Turns on amber for 3 seconds. / The battery level is between 20-70 %.
	It blinks red continuously. You can hear a notification sound once. / The battery level is below 20 %.
	It blinks red continuously. You can hear a notification sound once. / The battery level is below 10 %, and the battery needs to be charged.

✔ Note

When the amount of battery decreases, the length of the lighting Indicator is also shortened.

When the power cable is connected

Lighting Indicator	Indicator Status / Battery Status
	It blinks green for 3 seconds. / The battery level is above 70 %.
	It blinks amber for 3 seconds. / The battery level is between 20-70 %.
	It blinks red for 3 seconds. / The battery level is below 20 %.
	It blinks alternately light red and red for 3 seconds. / The battery level is below 10 %, and the battery needs to be charged.

Dot LED	LED Status / Battery Status
	Turns on in white. / Charging is complete. (When you press and hold the Power (⏻) button for 2 seconds, turns on green for 3 seconds.)
	Turns on in green. / The battery level is above 70 %.
	Turns on in amber. / The battery level is between 20-70 %.
	Turns on in red. / The battery level is below 20 %.

✔ Note

When the amount of battery decreases, the length of the lighting Indicator is also shortended.

Connecting to Bluetooth

Connecting Smartphone to the Speaker via Bluetooth

You can play tracks or run a music app on a **Bluetooth** device and enjoy the sounds through the speaker.

Please check the following first.

- **Bluetooth** specifications of the product.
 - Codec: SBC, AAC, LC3
- This product supports **Bluetooth** devices such as smartphones and laptops. How to connect the devices to the speaker may differ depending on device types and models. For information on how to connect the device, refer to the user manual of the external device to be connected.

Select the [**Bluetooth**] menu on the smartphone's **Settings** screen. The menu access method may differ depending on the smartphone manufacturer and model.

1 Press the **Power**  button on the speaker to turn it on. The lighting Indicator blinks.

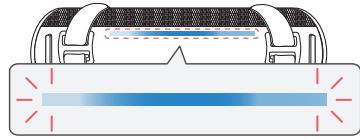

2 Tap the **Setting** (⚙️ / ⚙️) button on your smartphone and select **Bluetooth**.

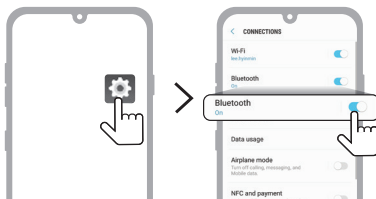

(Android Phone)

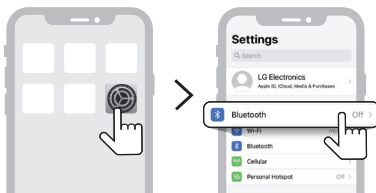

(iPhone)

3 Turn on the **Bluetooth** function. (Off > On)

4 When the Fast Pair connection pop-up appears on your smartphone screen, touch the pop-up to connect.

- Only Android™ 11 or higher is supported. **Bluetooth** and location information settings of the mobile device are required.

5 If the connection pop-up does not show up, select and connect the “xboom Grab” from the list of connectable devices on the smartphone.



- 6 Once the speaker and the smartphone are connected via **Bluetooth**, the lighting indicator will turn on with the sound.



- 7 If “xboom Grab” does not appear on the list, tap on the **Refresh**  icon on an Android phone or restart **Bluetooth** on an iPhone.

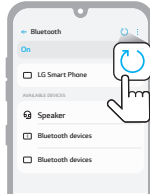

(Android Phone)

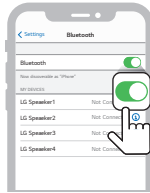

(iPhone)

- 8 Select and play a track on the smartphone.

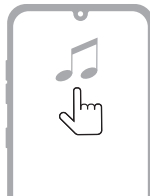

✔ **Note**

- The closer the **Bluetooth** device is to the speaker, the better connection you will get.
 - If no **Bluetooth** device is connected to the speaker, the lighting Indicator blinks. Connect the device again.
 - Adjust the volume of the **Bluetooth** device to an appropriate level when using it.
 - If you try to connect to the product via the **Bluetooth** device with a connection history, the product will automatically turn on and connect to the **Bluetooth** device. You can control this function in the **LG ThinQ app**. (→ See “Using Power On via Bluetooth” on page 30.)
-

Connecting Two Bluetooth Devices to the Speaker

Multi phone pairing

- 1 Connect one **Bluetooth** device to the speaker first. (→ See "Connecting Smartphone to the Speaker via Bluetooth" on page 14.)
- 2 When the **Bluetooth** device and speaker are connected, press the **Bluetooth**  button. Then the lighting Indicator blinks with the sound. The speaker is changed to multi phone pairing mode.



- 3 Connect a different **Bluetooth** device to the speaker within 1 minute. (→ See "Connecting Smartphone to the Speaker via Bluetooth" on page 14.)

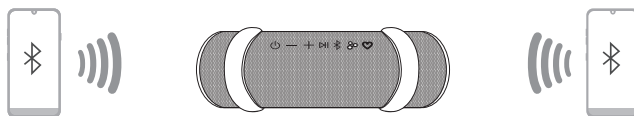

- 4 Once both the **Bluetooth** devices are connected to the speaker, the lighting Indicator turns on.







✓ Note

- Up to two **Bluetooth** devices can be connected to the speaker at the same time.
- If you turn the speaker off and back on while two **Bluetooth** devices are connected, only the device connected later is automatically connected.

Talking on the Phone Hands-free

- 1 Connect a smart device to the speaker. (→ See “Connecting Smartphone to the Speaker via Bluetooth” on page 14.)
- 2 You can use the Hands-Free function by operating as in the table below.



Function	How to Use
Receiving phone call	Press the Play/Pause  button.
Ending phone call	Press and hold the Play/Pause  button for 2 seconds.
Declining incoming call	Press and hold the Play/Pause  button for 2 seconds.
Muting voice while taking on the phone	Press the Play/Pause  button. The lighting Indicator turns on in white.

✔ Note

- While this function is being used, the voice command function is disabled.
- If both of the smartphones connected via Multi phone pairing are simultaneously used for phone call, the hands-free function may not work properly.
- Press the **Play/Pause**  button to cancel muting.

Using Voice command

You can turn on the Google Assistant or Siri function on your smartphone and use voice command through the speaker's microphone.

Please check the following first.

- Use a smart device that provides a voice command function.
- This function may not work depending on the **Bluetooth** device.

- 1 Connect the smartphone to the speaker via **Bluetooth**. (→ See "Connecting Smartphone to the Speaker via Bluetooth" on page 14.)
- 2 Press and hold the **Play/Pause**  button for 2 seconds.



- 3 Say a desired voice command for Google Assistant or Siri close to the speaker's microphone.

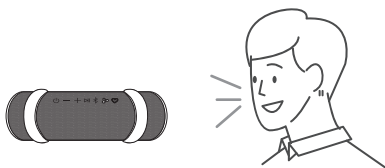

✔ Note

- While the hands-free function is being used, this function is disabled.
- If the voice command time limit is exceeded on the smartphone, the function is disabled automatically.
- Android devices may not support this function in some countries according to Google policies.
- If voice command does not work, check the smartphone.

Connecting to the LG ThinQ app

Installing app

Use the various functions of the speaker on the **LG ThinQ app**.

To install the **LG ThinQ app**, scan the QR code with an app or install **LG ThinQ** on the Google Play or App Store.

Please check the following first.

- The **LG ThinQ app** is available in the versions listed below.
 - Android™ OS: Version 9.0 or higher
 - iOS OS: Version 15.0 or higher
 - Minimum supported versions for each OS may change later.

Downloading with a QR code

- 1 Scan the QR code with a QR code scan app.
- 2 You will be directed to the page where you can download the **LG ThinQ app**. Tap the app to install it.



(Android Phone OS)



(iPhone OS)

Downloading in Google Play or App Store

- 1 Go to the Google Play or the App Store on your smartphone and search for the **LG ThinQ app** to install it.
- 2 Run the **LG ThinQ app** and log in to the app with your account. If you don't have an account, you can also create a new one.
- 3 Press the **add (+)** button and follow the instructions on the **LG ThinQ app** to register your product.

✔ Note

- The menu access method may differ depending on the smartphone manufacturer and OS.
 - Google, Android and Google Play are trademarks of Google LLC.
-

| Using MY function

The **MY** function allows you to play your music quickly and easily.

- 1 Set your **MY** function in the **LG ThinQ app**. Follow the instructions to set a playlist, volume level.
- 2 Press the **MY**  button.

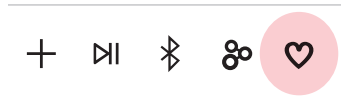

✔ Note

- To use the **MY** function, allow the media access permission.
 - The lighting indicator blinks white in the following cases:
 - If the **MY**  button in the **LG ThinQ app** is not set.
 - If your phone is an iPhone:
 - For some music source, an Apple Music subscription account and network connection are required.
 - If you don't subscribe to Apple Music, you will need music source files in the Apple Music library.
 - If your phone has Android OS installed:
 - Set the battery optimisation of the **LG ThinQ app** to "Unrestricted" in your smartphone settings.
 - **LG ThinQ app** notification permission is required for smooth play in the **MY** function.
 - You will need music source files on your phone.
-

Using the Party Link

You can connect multiple speakers. There are two ways for using the **Party Link** : Stereo mode and Multi mode. **Party Link** is only available among Auracast™-supported models from LG.

Stereo mode

Party Link Stereo mode lets you enjoy stereo sound with two same model speakers.

Please check the following first.

- The two speakers of the same model are needed.

- 1 Connect the speaker and a smartphone first. (→ See “Connecting Smartphone to the Speaker via Bluetooth” on page 14.)
- 2 Press the **Play/Pause** (⏮) button to play the music, then press the **Party Link** (🔗) button twice quickly.
- 3 Press the **Party Link** (🔗) button on the another speaker twice quickly.
- 4 You can see the lighting Indicator on the speakers.
 - Main speaker: The lighting Indicator and Dot LED turns on and output Left channel sound.
 - Other speaker: The lighting Indicator and Dot LED turns on and output Right channel sound.

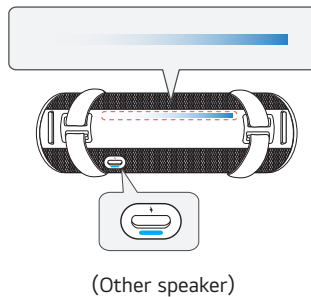
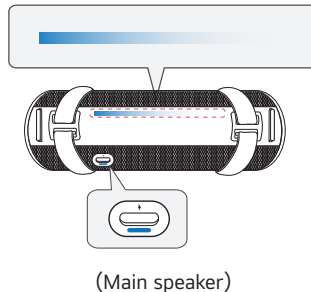

Multi mode

Party Link Multi mode lets you enjoy more powerful sound with multiple speakers.

Please check the following first.

- You can connect multiple LG **Bluetooth** speakers.

- 1 Connect the speaker and a smartphone first. (→ See “Connecting Smartphone to the Speaker via Bluetooth” on page 14.)
- 2 Press the **Play/Pause** (⏮) button to play the music, then press the **Party Link** (🔗) button.
- 3 Press the **Party Link** (🔗) button on the another speaker.
- 4 You can see the Dot LED on the speakers.
 - Main speaker: The Dot LED turns on and the speaker outputs sound.
 - Other speakers: The Dot LED turns on and speakers output sound in sync with the main speaker.

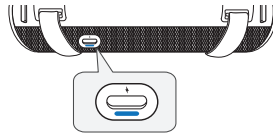

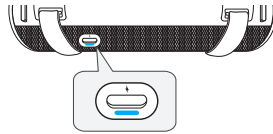

(Main speaker)



(Other speaker)

Note

- The Main speaker connects only one **Bluetooth** device.
 - When using Stereo/Multi mode to connect multiple speakers, the multi phone pairing connection is not supported.
 - In Multi mode, when you turn the speakers off and on again, the speakers do not automatically reconnect.
 - You can only use the Main speaker for calls.
 - To change the connected **Bluetooth** device in Stereo/Multi mode, press the **Bluetooth**  button. When you hear a beep sound and the lighting Indicator blinks, connect to the desired **Bluetooth** device.
 - Keep the distance between the speakers as close as possible each other.
 - Depending on the network environment, this function may not work well.
 - The screen of a device such as a TV and the sound from the speaker may not match.
 - When multiple speakers are connected in Multi mode, EQ linkage between the Main speaker and Other speakers is not available.
 - Press and hold the **Party Link**  button on one of the connected speakers for 2 seconds to cancel Stereo mode or Multi mode.
 - When you stop playing music in Multi mode, the speaker will change to Multi mode searching mode.
 - When using the speakers in Stereo mode, turning off the power of one speaker will also turn off both speakers. Afterward, when you turn the speakers back on, both speakers will automatically reconnect in Stereo mode. (If one speaker is powered on while the other speaker is set to "**Using Power On via Bluetooth**" (→ See "Using Power On via Bluetooth" on page 30.), the second speaker may also turn on automatically.)
 - When you don't want volume syncing between speakers in Multi mode connection, turn off the Multi mode volume control in the **LG ThinQ app**.
-

Interworking multiple speakers

This speaker interworks with other LG **Bluetooth** speakers. **Party Link** is only available among Auracast™-supported models from LG.

Stereo mode	Same model Main/Other
Volume	0
EQ	0
Lighting	0
Auto Power Management	0
Sleep Timer	0
Power Off	0

Multi mode	Same series Main/Other
Volume	0
Auto Power Management	0
Sleep Timer	0
Lighting	0

Multi mode	Other series Main/Other
Volume	0
Auto Power Management	0
Sleep Timer	0
Lighting	0

Listening Auracast™ broadcast

You can listen to broadcasts that are in progress around you in the Auracast™ broadcast listening in the **LG ThinQ app**.

- 1 Run the **LG ThinQ app** and select the Auracast™.
- 2 Select the Auracast™ broadcast you want to listen to from the searched list.
- 3 Once the Auracast™ broadcast is connected, you can listen to the broadcast through the speaker.

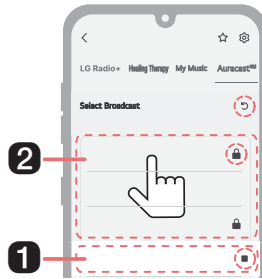

- 1 This is the broadcast you are currently listening to.
 - 2 In addition to the broadcast you are currently listening to, broadcasts that can be heard around you will appear in the list.
- ■ Stop Listening: Select to stop listening to the broadcast.
 - 🔍 Search: Press the button to search for broadcasts that can be heard around you.
 - 🔒 Lock symbol: Appears when a password is required.

✔ Note

- If a password is required, the Input password window will appear.
- If you play music or perform additional operations on a connected device while listening to Auracast™ broadcast, the Auracast™ connection may be disconnected.
- Depending on the device (smartphone, TV, etc.) that supports Auracast™ broadcasting, the sound may be out of sync.
- The degree of out of sync may vary depending on the device that supports Auracast™ broadcasting.
- For detailed instructions, please refer to the user manual of the device (smartphone, TV, etc.) that supports Auracast™ broadcasting.

Additional Functions

| Force the Speaker power off

You can force the speaker to power off when it operates improperly.

- 1 Press and hold the **Power** (⏻) button on the speaker for 10 seconds will turn off the speaker.

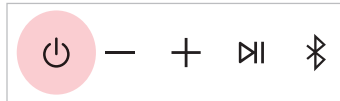

- 2 Turn on by pressing the **Power** (⏻) button.

| Initializing the speaker

You can initialize the speaker when it operates improperly.

Press and hold the **Bluetooth** (Ⓕ) button on the speaker for 7 seconds. The Dot LED will blink four times.



Using Auto Power Management

If there is no input signal or button operation, the speaker turns off automatically after 15 minutes.

✔ Note

- You can enable or disable this function on the **LG ThinQ app**.
 - If this function is disabled, the speaker turns off only when the **Power**  button is pressed or the battery is discharged.
 - Not using this feature may increase the energy consumption.
-

| Using Power On via Bluetooth

You can easily use the speaker with your **Bluetooth** device.

Please check the following first.

- The speaker has a history of **Bluetooth** connection with the **Bluetooth** device.
- The speaker is charging and the power is off.

- 1 Tap the **Setting** button on your **Bluetooth** device and select **Bluetooth**.
- 2 Turn on the **Bluetooth** function. (Off > On)
- 3 You will see a list of connectable devices on the **Bluetooth** device screen. Find and tap "xboom Grab".
- 4 The speaker power is turned on automatically. Then the **Bluetooth** device and the speaker are connected automatically.

✔ Note

- You can turn this function on and off with the **LG ThinQ app** only.
- If you set to [Always On] of this function on the **LG ThinQ app**, the product can be powered on via **Bluetooth** connection.
 - However if the battery level is below 20 %, this function does not work to prevent discharge. Charge the product if the battery LED blinks red.

How to deactivate the wireless network connection(s).

Set up the Auto power function to off by the app and turn off the product.

| Voice feedback function

When you select a function or sound, the current status of the product is guided by voice. (English voice only.)

You can turn this function on and off with the **LG ThinQ app** only.

Safety Precautions

| Safety and Regulatory



CAUTION: TO REDUCE THE RISK OF ELECTRIC SHOCK DO NOT REMOVE COVER (OR BACK) NO USER-SERVICEABLE PARTS INSIDE. REFER SERVICING TO QUALIFIED SERVICE PERSONNEL.



This lightning flash with arrowhead symbol within an equilateral triangle is intended to alert the user to the presence of uninsulated dangerous voltage within the product's enclosure that may be of sufficient magnitude to constitute a risk of electric shock to persons.



The exclamation point within an equilateral triangle is intended to alert the user to the presence of important operating and maintenance (servicing) instructions in the literature accompanying the product.

WARNING:

- TO PREVENT FIRE OR ELECTRIC SHOCK HAZARD, DO NOT EXPOSE THIS PRODUCT TO RAIN OR MOISTURE.
- Do not install this equipment in a confined space such as a book case or similar unit.

CAUTION:

- Do not use high voltage products around this product. (ex. Electrical swatter) This product may malfunction due to electrical shock.
- No naked flame sources, such as lighted candles, should be placed on the apparatus.
- Do not block any ventilation openings. Install in accordance with the manufacturer's instructions. Slots and openings in the cabinet are provided for ventilation and to ensure reliable operation of the product and to protect it from over heating. The openings should never be blocked by placing the product on a bed, sofa, rug or other similar surface. This product shall not be placed in a built-in installation such as a bookcase or rack unless proper ventilation is provided or the manufacturer's instruction has been adhered to.
- The apparatus should not be exposed to water (dripping or splashing) and no objects filled with liquids, such as vases, should be placed on the apparatus.
- For safety marking information including product identification and supply ratings, please refer to the main label on the bottom or the other surface of the product.

CAUTION concerning the Power Cord

The Power Plug is the disconnecting device. In case of an emergency, the Power Plug must remain readily accessible.

Check the specification page of this owner's manual to be certain of the current requirements.

Do not overload wall outlets. Overloaded wall outlets, loose or damaged wall outlets, extension cords, frayed power cords, or damaged or cracked wire insulation are dangerous. Any of these conditions could result in electric shock or fire. Periodically examine the cord of your device, and if its appearance indicates damage or deterioration, unplug it, discontinue use of the device, and have the cord replaced with an exact replacement part by an authorised service centre.

Protect the power cord from physical or mechanical abuse, such as being twisted, kinked, pinched, closed in a door, or walked upon. Pay particular attention to plugs, wall outlets, and the point where the cord exits the device.

CAUTION when using this product in environments of low humidity

- It may cause static electricity in environments of low humidity.
- To prevent static electricity, it is recommended to touch metal objects before using this product.

For models using a battery

This device is equipped with a portable battery or accumulator.

CAUTION: Risk of fire or explosion if the battery is replaced by an incorrect type.

NOTICE: For the safe use of the product, the product may adjust or block charging if excessive battery capacity reduction is detected. As the battery is a consumable, replace it if the usage time has significantly decreased.

For models using a built-in battery

Do not store or transport at pressures lower than 11.6 kPa and at above 15,000 m altitude.

- Replacement of a battery with an incorrect type that can defeat a safeguard (for example, in the case of some lithium battery types), must be replaced with the same type battery by expert;
- Disposal of a battery into fire or a hot oven, or mechanically crushing or cutting of a battery, that can result in an explosion;
- Leaving a battery in an extremely high temperature surrounding environment that can result in an explosion or the leakage of flammable liquid or gas;
- A battery subjected to extremely low air pressure that may result in an explosion or the leakage of flammable liquid or gas.

Symbols

 : Alternating current (AC).

 : Direct current (DC).

 : This is a class II equipment.

 : Standby power state.

 : The power is turned on.

 : Danger voltage.

Prevention of product misuse

To prevent misuse of the product, please be sure to check the contents below.

Precautions for installing the product

- Do not install the product in an unstable or vibrating place, such as on a shaking shelf or inclined surface. Install the product on a firm and level surface.
 - Otherwise, the product may fall or tip over and cause injury.
 - If you install the product on an unstable surface, the product may not work properly.
- If you install the product on a piece of furniture or shelf, make sure that the bottom front of the product does not protrude. Always use a piece of furniture or shelf that fits the product size.
 - Otherwise, the product may lose its balance and fall, causing injury or product damage.
- Install the product in a safe place. Otherwise, a child may bump into an edge of the product and get injured.
- Install the product in a place free from electromagnetic interference for proper operation.
- If you install the product in a place that does not meet the general use conditions, an unexpected quality problem may arise. So, make sure that you contact the service centre first before installing the product in such a place.
- Do not keep the product in a place where the temperature is too high above 35 °C or too low below 5 °C or a place with too much humidity.
- Avoid places exposed to direct sunlight or heat, e.g., near a heater. Do not use or keep flammable sprays or substances near the product.
 - Otherwise, there is a risk of explosion or fire.
- Do not install the product in a place with too much moisture, dust or soot.
 - Otherwise, it may cause a fire or electric shock.
- Do not install the product in a narrow space, such as inside a bookshelf, that does not ventilate well. Do not cover the product with a table cover or curtain.
 - Otherwise, it may increase the product temperature, causing a breakdown or fire.
- Connect the power plug of the product to a power outlet that is easily accessible.
 - When a fire or other problem occurs in the product, you must be able to remove the power plug quickly.
- Do not connect multiple products to one power outlet at the same time.
 - Otherwise, it may cause overheating, resulting in a fire.

Precautions for using the product

- Do not lift or move the product while it is operating.
 - Otherwise, it may cause a breakdown.
- When moving the product, pull out the power cord and all cables connected to the product.
 - Otherwise, it may cause a fire or electric shock.
- Stop using the product immediately if you notice smoke or a strange odor. In this case, turn off the power immediately, disconnect the power plug, and contact the service centre.
 - Using the product in this state may result in a fire or electric shock.
- Do not insert metal objects such as coins and hairpins or flammable objects such as paper and matchsticks into the product. Make sure that you tell any children not to do so.
 - Otherwise, it may cause a breakdown.
- If a foreign substance is inserted into the product, disconnect the power plug and contact the service centre.
- Do not put a heavy object on top of the product.
 - Otherwise, it may tip over or fall, causing injury.
- Make sure that a child does not hang on the product or get on it.
 - Otherwise, the product may tip over or fall, causing injury. Make sure that you tell any children not to do so.
- Remove the power plug during thunderstorms.
 - Otherwise, it may cause a fire.
- Do not place vessels with liquid, such as a vase, pot, cosmetics, or medicine, on top of the product.
 - Otherwise, it may result in a fire, electric shock, or injury due to its fall, etc.
- Make sure that you connect the power plug firmly. Do not use voltage other than the rated voltage indicated on the product.
 - An insecure connection may result in a fire.
- Do not insert a conductor, such as chopsticks, into the groove on the other side of the product while the power plug is connected to an outlet. Do not touch the power plug immediately after unplugging it from the outlet.
 - Otherwise, it may cause electric shock.
- Hold the power plug with dry hands.
 - Otherwise, it may cause electric shock.
- Do not move or push the product while holding a product cable such as a power cord.
 - The cable may get damaged and cause a breakdown or result in a fire or electric shock.
- When removing a cable plugged into the product, make sure that you hold the connector at the end of the cable. Do not hold the cable line.
 - Otherwise, it may result in an injury or the product may fall and cause a breakdown.
- Do not keep the product in a place exposed to heat, e.g., near a heater.
 - Otherwise, it may cause a fire or malfunction.
- Do not disassemble, repair, or modify the product.
 - Otherwise, it may cause a breakdown, resulting in a fire, electric shock, or injury.
- Keep plastic wraps out of reach of toddlers.
 - Otherwise, toddlers may choke on the plastic wraps.
- Do not drop an object on the product or make an impact on it. Keep the product away from places with severe vibrations or magnets.

- Do not damage, modify, bend, twist, or heat a power cord.
 - Otherwise, it can damage the power cord, resulting in a fire or electric shock.
- When you are not using the product for a prolonged period, such as when you are away from home, unplug the power cord from the power outlet.
 - If dust accumulates, it can cause heat, resulting in electric shock or fire due to a short circuit.
- Do not dispose of waste batteries together with regular waste. Dispose of them separately.
 - Otherwise, there is a risk of explosion or fire.
- Do not use high voltage products around this product. (ex. Electrical swatter)
 - This product may malfunction due to electrical shock.
- Do not touch the power plug immediately after unplugging it from the outlet.
 - Otherwise, it may cause electric shock.
- Connect the power plug to a grounded outlet or extension cord. (This does not apply to products without a ground.)
 - Otherwise, it may cause a breakdown or electric shock due to a short circuit.
- In the case of a product with a vent, keeping the product turned on for a prolonged period can result in the vent getting hot. Do not touch the vent when it is hot. The heat is not a fault of the product and does not cause any malfunction. So, you may use the product without worry.
- Do not damage the power cable, AC adapter, or power plug. Do not place a heavy object on top of the power cable or AC adapter.
 - Otherwise, it may cause a fire or electric shock.
- If dust, dirt, etc. is found on the power plug pins, an AC adapter, or a power outlet, wipe it completely.
 - Otherwise, it may cause a fire.
- In the case of a product with a power cord or AC adapter, use only genuine power cords and AC adapters provided by LG Electronics.
 - Otherwise, it may cause a fire or electric shock.
- If you are using headphones or earphones, do not turn on the volume too loudly or use them for a prolonged period. [This only applies to models that support headphones or earphones]
 - Otherwise, it may negatively affect your hearing ability.
- The software of this product can be updated with the **LG ThinQ app**. Do not turn off the power of the product while updating the software. Once the update is complete, the product power turns off automatically.
 - If you turn off the power of the product while the software is being updated, it may cause a product malfunction.

The following only applies to models with a remote control

- Do not let children use the remote control. Keep the remote control out of reach of toddlers.
- Do not let children put the remote control in their mouth. Make sure that children don't swallow the remote control cover or a battery. If a child swallowed one, consult a physician immediately.
- Beware that children may step on the remote control cover and get injured.
- Remove obstacles between the product and the remote control for the smooth operation of the remote control.

The following only applies to models that use optical discs

- Do not insert your hand into a disc drive or pull it out forcefully.
- Make sure that children do not insert their hands into the disc drive.

The following only applies to models that able to watch video

- Refrain from watching a 3D video if you didn't have enough sleep or after drinking alcohol.
 - Some 3D videos may surprise or excite people.
- If any of the following symptoms occur while watching a video, stop watching it immediately and take a rest.
 - If any of the symptoms continue, consult a physician. Vertigo, burning sensation of eyes or face, unconscious motion, spasm, clouded consciousness, confusion, disorientation, nausea.
- You may suffer a symptom such as a seizure when you watch a certain image in a video or game or a video with a certain pattern or flashing lights. If you or any of your relatives have a history of epilepsy or seizures, consult a physician before watching.
- When you watch a 3D video, remove objects that are fragile or can cause injury from your surroundings.
 - If you mistake a 3D video as real or move your body with surprise, you or your nearby relatives may get injured or objects near you may get damaged.

Precautions for cleaning the product

- Do not spray water directly onto the product when cleaning it.
 - Otherwise, it may cause a fire or electric shock.
- When cleaning the product, make sure that you pull out the power cord first and wipe the surface of the product lightly with a dry cloth. Do not use chemicals or detergents when cleaning the product. They may deteriorate the product surface or peel off the paint from the product (benzene, alcohol, etc.).

Before Reporting Product Malfunction

Troubleshooting

If you experience the following issues while using the product, please perform several checks, as they may not be malfunctions.

Symptom	Cause and Solution
Power is not supplied.	<ul style="list-style-type: none">• The battery is discharged. Recharge the battery.• Connect the speaker to the charging adapter.
There is no sound or the sound is distorted.	<ul style="list-style-type: none">• The volume of the speaker or the smart device may be set to the minimum. Adjust the volume on the speaker or the smart device appropriately.• Turning on the volume to the maximum on the external device may result in distorted sounds. Lower the volume on the external device.
Bluetooth connection failed.	<ul style="list-style-type: none">• Turn off the Bluetooth setting and on again on the Bluetooth device.• Check if the Bluetooth setting is enabled.• Make sure that there is no obstacle between the speaker and the Bluetooth device.• Bluetooth pairing may fail depending on the Bluetooth device type and the surrounding environment.
The device does not operate normally.	<ul style="list-style-type: none">• Battery discharge may cause the Bluetooth information to be deleted. If the speaker's power supply is blocked, previous settings may not be saved.• Use this product in a place where the temperature and humidity are not too high or low. If the problem continues, contact LG Electronics' Customer Service Centre.• The Dot LED blinks when the speaker malfunction occurs and the speaker does not operate normally. Turn the power off and then on again.• If a problem occurs while charging the battery of the product, the Dot LED alternates between red and amber and charging stops. Unplug the adapter from the outlet.
The above solutions do not work.	<ul style="list-style-type: none">• Press and hold the Power (⏻) button on the speaker for 10 seconds. (→ See "Force the Speaker power off" on page 28.)• Press and hold the Bluetooth (📶) button on the speaker for 7 seconds. (→ See "Initializing the speaker" on page 28.)

Appendix

Specifications

General	
Power Supply	5 V  2.5 A (AC adapter) Built-in rechargeable battery
Power consumption	Refer to the main label.
Dimensions (W x H x D)	Approx. 211.0 mm x 71.6 mm x 70.0 mm
Temperature	5 °C - 35 °C
Humidity	5 % - 80 % RH
Ingress Protection	IP67 - Speaker tested under controlled laboratory conditions with an IP67 rating. - Solid: The unit is dust-tight. - Liquid: Water resistant up to 1 meter for up to 30 minutes. Tested in fresh water. Dry before using. Do not charge while wet.

Battery	
Battery capacity	4,700 mAh
Operating time	Up to 20 hours Based on 50% volume, no lighting and Voice Enhance EQ. (Internal test result.) Actual usage time may vary.
Charging time	3 hours Charging time may vary depending on the battery or operation status.

- Design and specifications are subject to change without notice.

| Registered Trademarks and Licenses

All trademarks and trade names are the property of their respective owners.

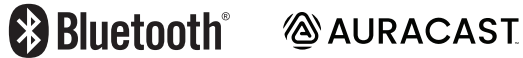

The **Bluetooth**® word mark and logos are registered trademarks owned by the **Bluetooth** SIG, Inc. The **Auracast**™ word mark and logos are trademarks owned by the **Bluetooth** SIG. Any use of such marks by LG Electronics is under license.

Other trademarks and trade names are those of their respective owners.

Android, Google Play, the Google Play logo, and other related marks and logos are trademarks of Google LLC.



Use of the Made for Apple badge means that an accessory has been designed to connect specifically to the Apple product(s) identified in the badge and has been certified by the developer to meet Apple performance standards. Apple is not responsible for the operation of this device or its compliance with safety and regulatory standards. Apple, Apple TV, Apple Watch, iPad, iPad Air, iPad Pro, iPhone, Lightning, and tvOS are trademarks of Apple Inc., registered in the U.S. and other countries and regions.

| Open Source Software Notice Information

To obtain the source code that is contained in this product, under GPL, LGPL, MPL, and other open source licenses that have the obligation to disclose source code, and to access all referred license terms, copyright notices and other relevant documents, please visit <https://opensource.lge.com>.

LG Electronics will also provide open source code to you on CD-ROM for a charge covering the cost of performing such distribution (such as the cost of media, shipping, and handling) upon email request to opensource@lge.com.

This offer is valid to anyone in receipt of this information for a period of three years after our last shipment of this product.

| Handling the Product

When shipping the Product

Please save the original shipping carton and packing materials. If you need to ship the product, for maximum protection, re-pack the product as it was originally packed at the factory.

Keeping the exterior surfaces clean

- Do not use volatile liquids such as insecticide spray near the product.
- Wiping with strong pressure may damage the surface.
- Do not leave rubber or plastic products in contact with the product for a long period of time.

Cleaning the product

To clean the product, use a soft, dry cloth. If the surfaces are extremely dirty, use a soft cloth lightly moistened with a mild detergent solution. Do not use strong solvents such as alcohol, benzene, or thinner, as these might damage the surface of the product.

