



# OWNER'S MANUAL

## LED LCD TV / LCD TV

Please read this manual carefully before operating your set and retain it for future reference.

### LED LCD TV MODELS

19LE5300	32LE5300	42LE7300
22LE5300	37LE5300	47LE7300
26LE5300	42LE5300	55LE7300
22LE5500	47LE5300	42LE530C
26LE5500	55LE5300	47LE530C
		55LE530C

### LCD TV MODELS

32LD420	32LD520	37LD450C	32LD452C
42LD420	42LD520	42LD450C	37LD452C
47LD420	47LD520	47LD450C	42LD452C
32LD450	55LD520	55LD520C	47LD452C
37LD450	42LD630	42LD451C	32LD452B
42LD450	47LD630	47LD451C	42LD452B
47LD450	55LD630	26LD352C	47LD452B

# WARNING / CAUTION



**WARNING / CAUTION**  
RISK OF ELECTRIC SHOCK  
DO NOT OPEN



TO REDUCE THE RISK OF ELECTRIC SHOCK DO NOT REMOVE COVER (OR BACK). NO USER SERVICEABLE PARTS INSIDE. REFER TO QUALIFIED SERVICE PERSONNEL.



The lightning flash with arrowhead symbol, within an equilateral triangle, is intended to alert the user to the presence of uninsulated "dangerous voltage" within the product's enclosure that may be of sufficient magnitude to constitute a risk of electric shock to persons.



The exclamation point within an equilateral triangle is intended to alert the user to the presence of important operating and maintenance (servicing) instructions in the literature accompanying the appliance.

## WARNING/CAUTION

TO REDUCE THE RISK OF FIRE AND ELECTRIC SHOCK, DO NOT EXPOSE THIS PRODUCT TO RAIN OR MOISTURE.

## NOTE TO CABLE/TV INSTALLER

This reminder is provided to call the CATV system installer's attention to Article 820-40 of the National Electric Code (U.S.A.). The code provides guidelines for proper grounding and, in particular, specifies that the cable ground shall be connected to the grounding system of the building, as close to the point of the cable entry as practical.

# WARNING / CAUTION

To prevent fire or shock hazards, do not expose this product to rain or moisture.

## FCC Notice

### Class B digital device

This equipment has been tested and found to comply with the limits for a Class B digital device, pursuant to Part 15 of the FCC Rules. These limits are designed to provide reasonable protection against harmful interference in a residential installation. This equipment generates, uses and can radiate radio frequency energy and, if not installed and used in accordance with the instructions, may cause harmful interference to radio communications. However, there is no guarantee that interference will not occur in a particular installation. If this equipment does cause harmful interference to radio or television reception, which can be determined by turning the equipment off and on, the user is encouraged to try to correct the interference by one or more of the following measures:

- Reorient or relocate the receiving antenna.
- Increase the separation between the equipment and receiver.
- Connect the equipment to an outlet on a circuit different from that to which the receiver is connected.
- Consult the dealer or an experienced radio/TV technician for help.

This device complies with part 15 of the FCC Rules.

Operation is subject to the following two conditions: (1) This device may not cause (harmful) interference, and (2) this device must accept any interference received, including interference that may cause undesired operation (of the device).

Any changes or modifications in construction of this device which are not expressly approved by the party responsible for compliance could void the user's authority to operate the equipment.

## CAUTION

Do not attempt to modify this product in any way without written authorization from LG Electronics.

Unauthorized modification could void the user's authority to operate this product.

# SAFETY INSTRUCTIONS

## IMPORTANT SAFETY INSTRUCTIONS

Read these instructions.

Keep these instructions.

Heed all warnings.

Follow all instructions.



- 1** Do not use this apparatus near water.



- 2** Clean only with dry cloth.



- 3** Do not block any ventilation openings. Install in accordance with the manufacturer's instructions.

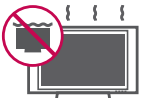

- 4** Do not install near any heat sources such as radiators, heat registers, stoves, or other apparatus (including amplifiers) that produce heat.



- 5** Do not defeat the safety purpose of the polarized or grounding-type plug. A polarized plug has two blades with one wider than the other. A grounding type plug has two blades and a third grounding prong. The wide blade or the third prong are provided for your safety. If the provided plug does not fit into your outlet, consult an electrician for replacement of the obsolete outlet.



- 6** Protect the power cord from being walked on or pinched particularly at plugs, convenience receptacles, and the point where they exit from the apparatus.



- 7** Only use attachments/accessories specified by the manufacturer.



- 8** Use only with the cart, stand, tripod, bracket, or table specified by the manufacturer, or sold with the apparatus. When a cart is used, use caution when moving the cart/apparatus combination to avoid injury from tip-over.



S3125A

- 9** Unplug this apparatus during lightning storms or when unused for long periods of time.

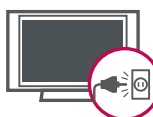

- 10** Refer all servicing to qualified service personnel. Servicing is required when the apparatus has been damaged in any way, such as power-supply cord or plug is damaged, liquid has been spilled or objects have fallen into the apparatus, the apparatus has been exposed to rain or moisture, does not operate normally, or has been dropped.



- 11** Never touch this apparatus or antenna during a thunder or lightning storm.

- 12** When mounting a TV on the wall, make sure not to install the TV by the hanging power and signal cables on the back of the TV.

- 13** Do not allow an impact shock or any objects to fall into the product, and do not drop onto the screen with something.

- 14** CAUTION concerning the Power Cord: It is recommend that appliances be placed upon a dedicated circuit; that is, a single outlet circuit which powers only that appliance and has no additional outlets or branch circuits. Check the specification page of this owner's manual to be certain. Do not connect too many appliances to the same AC power outlet as this could result in fire or electric shock.

Do not overload wall outlets. Overloaded wall outlets, loose or damaged wall outlets, extension cords, frayed power cords, or damaged or cracked wire insulation are dangerous. Any of these conditions could result in electric shock or fire. Periodically examine the cord of your appliance, and if its appearance indicates damage or deterioration, unplug it, discontinue use of the appliance, and have the cord replaced with an exact replacement part by an authorized servicer. Protect the power cord from physical or mechanical abuse, such as being twisted, kinked, pinched, closed in a door, or walked upon. Pay particular attention to plugs, wall outlets, and the point where the cord exits the appliance.

Do not make the TV with the power cord plugged in. Do not use a damaged or loose power cord. Be sure do grasp the plug when unplugging the power cord. Do not pull on the power cord to unplug the TV.



# SAFETY INSTRUCTIONS

**15** **WARNING** - To reduce the risk of fire or electrical shock, do not expose this product to rain, moisture or other liquids. Do not touch the TV with wet hands. Do not install this product near flammable objects such as gasoline or candles or expose the TV to direct air conditioning.



**16** Do not expose to dripping or splashing and do not place objects filled with liquids, such as vases, cups, etc. on or over the apparatus (e.g. on shelves above the unit).



## **17** GROUNDING

Ensure that you connect the earth ground wire to prevent possible electric shock (i.e. a TV with a three-prong grounded AC plug must be connected to a three-prong grounded AC outlet). If grounding methods are not possible, have a qualified electrician install a separate circuit breaker.

Do not try to ground the unit by connecting it to telephone wires, lightning rods, or gas pipes.

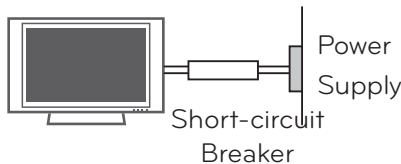

## **18** DISCONNECTING DEVICE FROM MAINS

Mains plug is the disconnecting device. The plug must remain readily operable.

**19** As long as this unit is connected to the AC wall outlet, it is not disconnected from the AC power source even if you turn off this unit by SWITCH.

## **20** Cleaning

When cleaning, unplug the power cord and scrub gently with a soft cloth to prevent scratching. Do not spray water or other liquids directly on the TV as electric shock may occur. Do not clean with chemicals such as alcohol, thinners or benzene.

## **21** Moving

Make sure the product is turned off, unplugged and all cables have been removed. It may take 2 or more people to carry larger TVs. Do not press against or put stress on the front panel of the TV.

## **22** ANTENNAS

### **Outdoor antenna grounding**

If an outdoor antenna is installed, follow the precautions below. An outdoor antenna system should not be located in the vicinity of overhead power lines or other electric light or power circuits, or where it can come in contact with such power lines or circuits as death or serious injury can occur.

Be sure the antenna system is grounded so as to provide some protection against voltage surges and built-up static charges.

Section 810 of the National Electrical Code (NEC) in the U.S.A. provides information with respect to proper grounding of the mast and supporting structure, grounding of the lead-in wire to an antenna discharge unit, size of grounding conductors, location of antenna discharge unit, connection to grounding electrodes and requirements for the grounding electrode.

### **Antenna grounding according to the National Electrical Code, ANSI/NFPA 70**

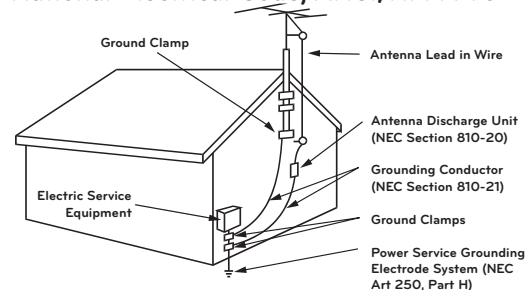

NEC: National Electrical Code

## **23** Ventilation

Install your TV where there is proper ventilation. Do not install in a confined space such as a bookcase. Do not cover the product with cloth or other materials (e.g.) plastic while plugged in. Do not install in excessively dusty places.

**24** Take care not to touch the ventilation openings. When watching the TV for a long period, the ventilation openings may become hot.

**25** If you smell smoke or other odors coming from the TV, unplug the power cord contact and authorized service center.

**26** Do not press strongly upon the panel with hand or sharp object such as nail, pencil or pen, or make a scratch on it.



**27** Keep the product away from direct sunlight.

### **28** Dot Defect

The Plasma or LCD panel is a high technology product with resolution of two million to six million pixels. In a very few cases, you could see fine dots on the screen while you're viewing the TV. Those dots are deactivated pixels and do not affect the performance and reliability of the TV.

---

### **29** Generated Sound

"Cracking" noise: A cracking noise that occurs when watching or turning off the TV is generated by plastic thermal contraction due to temperature and humidity. This noise is common for products where thermal deformation is required.

Electrical circuit humming/panel buzzing: A low level noise is generated from a high-speed switching circuit, which supplies a large amount of current to operate a product. It varies depending on the product.

This generated sound does not affect the performance and reliability of the product.

---

### **30** For LED LCD TV/LCD TV

If the TV feels cold to the touch, there may be a small "flicker" when it is turned on. This is normal, there is nothing wrong with TV.

Some minute dot defects may be visible on the screen, appearing as tiny red, green, or blue spots. However, they have no adverse effect on the monitor's performance.

Avoid touching the LCD screen or holding your finger(s) against it for long periods of time. Doing so may produce some temporary distortion effects on the screen.

### **ON DISPOSAL**

#### **(Only Hg lamp used LCD TV)**

The fluorescent lamp used in this product contains a small amount of mercury. Do not dispose of this product with general household waste. Disposal of this product must be carried out in accordance to the regulations of your local authority.

# CONTENTS

<b>WARNING / CAUTION</b> .....	2
<b>SAFETY INSTRUCTIONS</b>	
Important Safety Instructions .....	3
<b>FEATURE OF THIS TV</b> .....	8

## PREPARATION

Accessories .....	9
Front Panel Information .....	11
Back Panel Information .....	16
Stand Instructions .....	20
VESA wall mounting .....	28
Cable Management .....	30
Desktop Pedestal Installation .....	32
Swivel Stand .....	32
Kensington Security System .....	32
Attaching the TV to a Desk .....	33
Securing the TV to the Wall to Prevent Falling when the TV is used on a stand .....	34
Antenna or Cable Connection .....	35

## EXTERNAL EQUIPMENT SETUP

HD Receiver setup .....	36
DVD setup .....	39
VCR SETUP .....	41
Other A/V Source Setup .....	42
USB Connection .....	43
Headphone Setup .....	43
Audio out Connection .....	44
PC Setup .....	45

## WATCHING TV / CHANNEL CONTROL

Remote Control Functions .....	52
Turning on the TV .....	54
Channel Selection .....	54
Volume Adjustment .....	54
Initial Setting .....	55
On-Screen Menus Selection .....	57
Quick menu .....	59
Customer Support	

- Picture Test / Sound Test .....	60
- Product/Service Info .....	61
Simple Manual .....	62
Channel Setup	
- Auto Scan (Auto Tuning) .....	63
- Add/Delete Channel (Manual Tuning) .....	64
- Channel Editing .....	65
Favorite Channel Setup .....	66
Favorite Channel List .....	66
Channel List .....	67
Channel Information .....	68
Channel Brief Information .....	69
Input List .....	70
Input Label .....	71
Reset to factory default (Initial Setting) .....	72
Mode Setting .....	73
Demo Mode .....	74
AV Mode .....	75
SIMPLINK .....	76

## MY MEDIA

Connection Method .....	78
Entry Mode .....	79
Movie List .....	80
Photo List .....	87
Music List .....	93
Extra Contents .....	97
EzSign TV .....	98
DivX Registration Code /Deactivation .....	99

## PICTURE CONTROL

Picture Size (Aspect Ratio) Control .....	100
Picture Wizard .....	102
 Energy Saving .....	104
Preset Picture Settings (Picture mode) .....	105
Manual Picture Adjustment - User Mode .....	106
Picture Improvement Technology (Advanced Control) .....	107
Expert Picture Control .....	108
Picture Reset .....	111
Power Indicator .....	111
TruMotion .....	112

## SOUND & LANGUAGE CONTROL

Auto Volume.....	113
Clear Voice II .....	114
Balance .....	115
Preset Sound Settings (Sound Mode) .....	116
Sound Setting Adjustment - User Mode...	117
Audio Reset.....	118
TV Speakers On/Off Setup .....	119
External Speakers On/Off Setup .....	119
Stereo/SAP Broadcast Setup .....	120
Audio Language .....	121
On-screen Menus Language Selection ....	122
Caption Mode	
- Analog Broadcasting System Captions.	123
- Digital Broadcasting System Captions...	124
- Caption Option.....	125

## TIME SETTING

Clock Setting	
- Auto Clock Setup.....	126
- Manual Clock Setup .....	127
Auto On/Off Time Setting.....	128
Sleep Timer Setting .....	129
Auto Shut-Off Setting.....	129

## PARENTAL CONTROL / RATINGS

Set Password & Lock System	
- Setting up Your Password.....	130
- Set Password .....	131
- Lock System.....	132
Channel Blocking.....	133
Movie & TV Rating .....	134
Downloadable Rating.....	139
External Input Blocking .....	140
Key Lock.....	141

## APPENDIX

Troubleshooting .....	142
Maintenance.....	145
Product Specifications .....	146
IR Code.....	151
External Control through RS-232C .....	152
Open Source License.....	158

# FEATURE OF THIS TV

- Some of these features are not available on all models.



High-definition television. High-resolution digital television broadcast and playback system composed of roughly a million or more pixels, 16:9 aspect-ratio screens, and AC3 digital audio. A subset of digital television, HDTV formats include 1080i and 720p resolutions.



AV Mode is three preset picture and audio settings. It allows the viewer to quickly switch between common settings. It includes Cinema, Sports, and Game Modes.



A unique invisible speaker system tuned by renowned audio expert, Mr. Mark Levinson. Speakers are embedded in strategic spots behind the front cabinet and use minute vibrations to turn the entire front bezel into the speaker system. The result is a clean, polished look, and enhanced audio by increasing the "sweet spot", giving a wider and richer sound field.



Automatically enhances and amplifies the sound of human voice frequency range to help keep dialogue audible when background noise swells.



Unlike other sensors which can only sense brightness of ambient light, LG's "Intelligent Sensor" uses 4,096 sensing steps to evaluate its surroundings. Using a sophisticated algorithm, the LG processes picture quality elements including brightness, contrast, color, sharpness and white balance. The result is a picture optimized for its surroundings, more pleasing to watch and which can also save up to 50% in power consumption.



Manufactured under license from Dolby Laboratories. "Dolby" and the double-D symbol are trademarks of Dolby Laboratories.



HDMI, the HDMI logo and High-Definition Multimedia Interface are trademarks or registered trademarks of HDMI Licensing LLC."



Displays HDTV programs in full 1920 x 1080p resolution for a more detailed picture.



View videos and photos and listen to music on your TV through USB 2.0 ('videos' dependent on model).



ABOUT DIVX VIDEO: DivX® is a digital video format created by DivX, Inc. This is an official DivX Certified device that plays DivX video. Visit [www.divx.com](http://www.divx.com) for more information and software tools to convert your files into DivX video.

ABOUT DIVX VIDEO-ON-DEMAND: This DivX Certified® device must be registered in order to play DivX Video-on-Demand (VOD) content. To generate the registration code, locate the DivX VOD section in the device setup menu. Go to [vod.divx.com](http://vod.divx.com) with this code to complete the registration process and learn more about DivX VOD.

"DivX Certified® to play DivX® video up to HD 1080p, including premium content"

"DivX®, DivX Certified® and associated logos are registered trademarks of DivX, Inc. and are used under license."

Pat. 7,295,673; 7,460,668; 7,515,710; 7,519,274



## IMPORTANT INFORMATION TO PREVENT "IMAGE BURN / BURN-IN" ON YOUR TV SCREEN

- When a fixed image (e.g. logos, screen menus, video game, and computer display) is displayed on the TV for an extended period, it can become permanently imprinted on the screen. This phenomenon is known as "image burn" or "burn-in." Image burn is not covered under the manufacturer's warranty.
- In order to prevent image burn, avoid displaying a fixed image on your TV screen for a prolonged period (2 or more hours for LCD, 1 or more hours for Plasma).
- Image burn can also occur on the letterboxed areas of your TV if you use the 4:3 aspect ratio setting for an extended period.

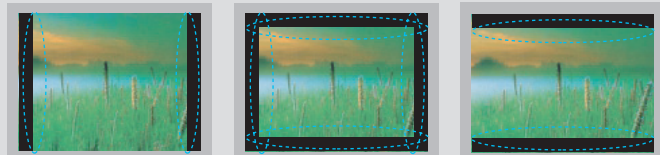

# PREPARATION

## ACCESSORIES

Ensure that the following accessories are included with your TV. If an accessory is missing, please contact the dealer where you purchased the TV.

The accessories included may differ from the images below.

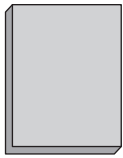

Owner's Manual



CD Manual

(For 32/42/47LD452B)

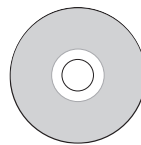

EzSign TV Editor  
S/W & Manual

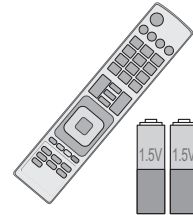

Remote Control,  
Batteries (AAA)

### Not included with all models

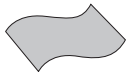

Polishing Cloth

- \* Wipe spots on the exterior only with the polishing cloth.
- \* Do not wipe roughly when removing stains. Excessive pressure may cause scratches or discoloration.

### Option Extras

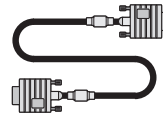

D-sub 15 pin Cable

When using the VGA (D-sub 15 pin cable) PC connection, the user must use shielded signal interface cables with ferrite cores to maintain standards compliance.

### 19/22/26LE5300, 22/26LE5500



(M4 x 14) x 4

Screws for stand assembly  
(Refer to P.20, 22)

(For 26LE5300,  
26LE5500)

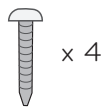

(M4 x 20) x 4



Cable Holder  
(Refer to p.31)

(For 26LE5300,  
26LE5500)



Ring spacers x 4

Ring spacers  
(Refer to p.29)



AC/DC Adapter



Power Cord

### 32/37/42/47LD450, 37/42/47LD450C, 42/47/55LD630, 42/47LD451C, 32/37/42/47LD452C, 32/42/47LD452B, 26LD352C



(M4 x 20) x 8

Screws for stand  
assembly  
(Refer to P.24)

(For 32/37/42LD450, 37/42/LD450C,  
42LD630, 42LD451C, 32/37/42LD452C,  
32/42LD452B, 26LD352C)

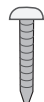

Screws for stand fixing  
(Refer to P.33)



Protection Cover  
(Refer to P.25)



Power Cord

(For 37/42/47LD450C,  
32/37/42/47LD452C,  
32/42/47LD452B,  
26LD352C)

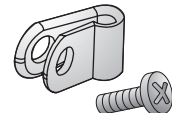





Protective Bracket  
and Screw for  
Power Cord  
(Refer to P.30)





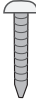

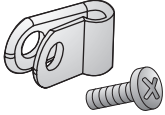



# PREPARATION

PREPARATION

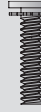
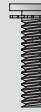
**32/42/47LD420, 32/42/47/55LD520, 55LD520C**

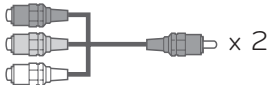
<p>(For 55LD520C, 55LD520)</p>  <p>x 4                      x 4</p> <p>(M4 x 24)              (M4 x 14)</p> <p>Screws for stand assembly (Refer to P.26)</p>	<p>(For 55LD520C)</p>  <p>x 2</p> <p>Torx plus Star head screw (Refer to P.26)</p>	<p>(Except 47LD420, 47/55LD520, 55LD520C)</p>  <p>Screw for stand fixing (Refer to P.33)</p>
 <p>Protection Cover (Refer to P.27)</p>	 <p>Power Cord</p>	<p>(For 55LD520C)</p>  <p>Protective Bracket and Screw for Power Cord (Refer to P.30)</p>

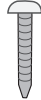
**32/37/42/47/55LE5300, 42/47/55LE7300, 42/47/55LE530C**

<p><b>(32/37/42/47/55LE5300, 42/47/55LE530C)</b></p>			
<p>(32LE5300)</p>  <p>x 4</p> <p>(M4 x 22)</p>	<p>(37/42LE5300, 42LE530C)</p>  <p>x 4</p> <p>(M4 x 24)</p>	<p>(47/55LE5300, 47/55LE530C)</p>  <p>x 4</p> <p>(M4 x 26)</p>	 <p>x 4</p> <p>(M4 x 16)</p>
<p>Screws for stand assembly (Refer to P.22)</p>			
<p>(42/47LE7300)</p>  <p>x 3</p> <p>(M4 x 20)</p>		 <p>x 4</p> <p>(M4 x 12)</p>	<p>(55LE7300)</p>  <p>x 3</p> <p>(M4 x 26)</p>
<p>Screws for stand assembly (Refer to P.21)</p>			
 <p>Cable Holder (Refer to p.31)</p>	 <p>x 2</p> <p>Component gender cable, AV gender cable</p>	<p>(For 42/47/55LE7300)</p>  <p>Cable Management Clip (Refer to p.31)</p>	<p>(For 32LE5300)</p>  <p>Screw for stand fixing (Refer to P.33)</p>
		<p>(For 42/47/55LE530C)</p>  <p>x 2</p> <p>Torx plus Star head screw (Refer to P.22)</p>	

# FRONT PANEL INFORMATION

■ Image shown may differ from your TV.

## NOTE

▶ In case of some model, the thin film on screen is a part of TV, So don't take it off.

19/22/26/32/37/42/47/55LE5300,  
22/26LE5500, 42/47/55LE530C

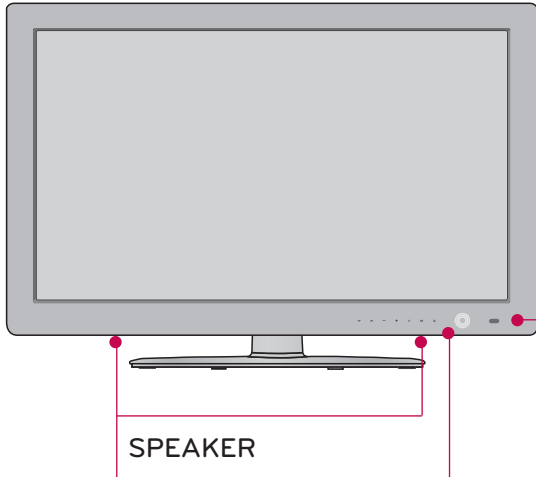

19/22/26LE5300, 22/26LE5500

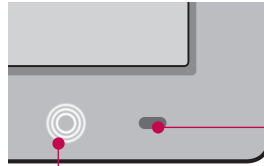

Remote Control Sensor

Power/Standby Indicator

(Can be adjusted using the **Power Indicator** in the OPTION menu.▶p.111)

32/37/42/47/55LE5300, 42/47/55LE530C

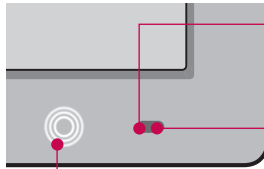

Remote Control Sensor

Intelligent Sensor

Adjusts picture according to the surrounding conditions

Power/Standby Indicator

(Can be adjusted using the **Power Indicator** in the OPTION menu.▶p.111)

19/22/26LE5300, 22/26LE5500



CHANNEL  
( $\downarrow$ ,  $\uparrow$ )  
Buttons

VOLUME  
(-, +)  
Buttons

ENTER  
Button

MENU  
Button

INPUT  
Button

POWER  
Button

32/37/42/47/55LE5300, 42/47/55LE530C



CHANNEL  
( $\downarrow$ ,  $\uparrow$ )  
Buttons

VOLUME  
(-, +)  
Buttons

ENTER  
Button

MENU  
Button

INPUT  
Button

POWER  
Button

# PREPARATION

PREPARATION

■ Image shown may differ from your TV.

32/37/42/47LD450, 37/42/47LD450C, 42/47LD451C, 32/37/42/47LD452C, 32/42/47LD452B

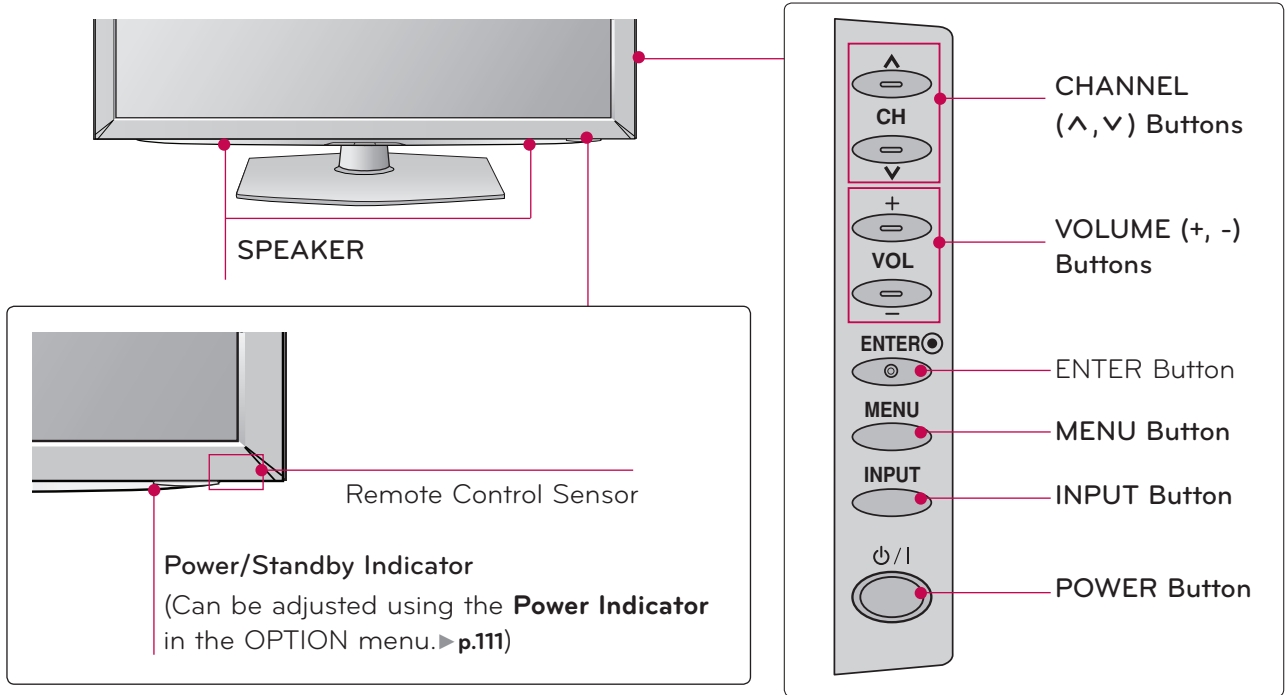

26LD352C

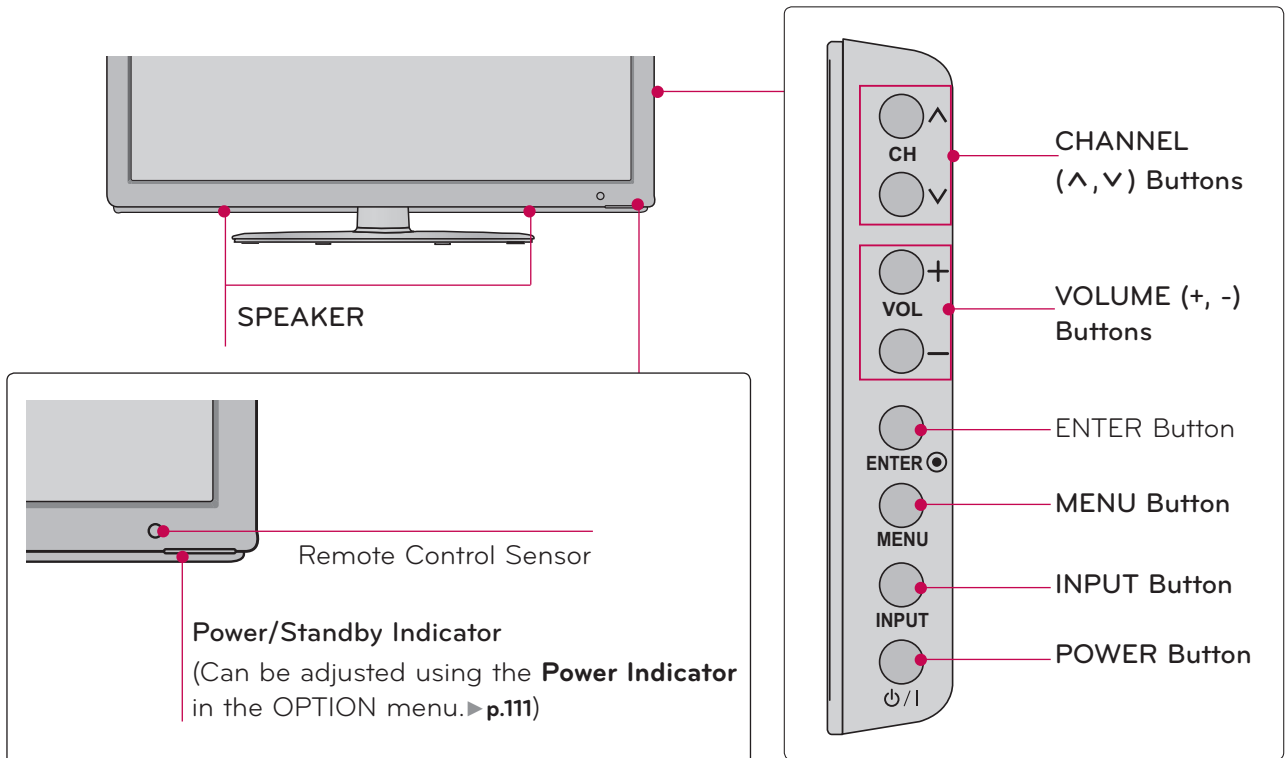

42/47/55LD630

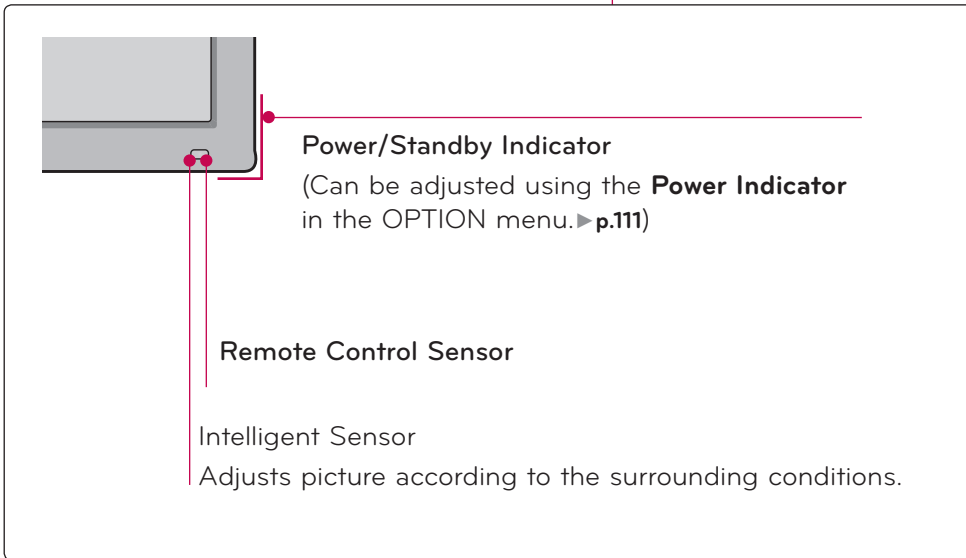
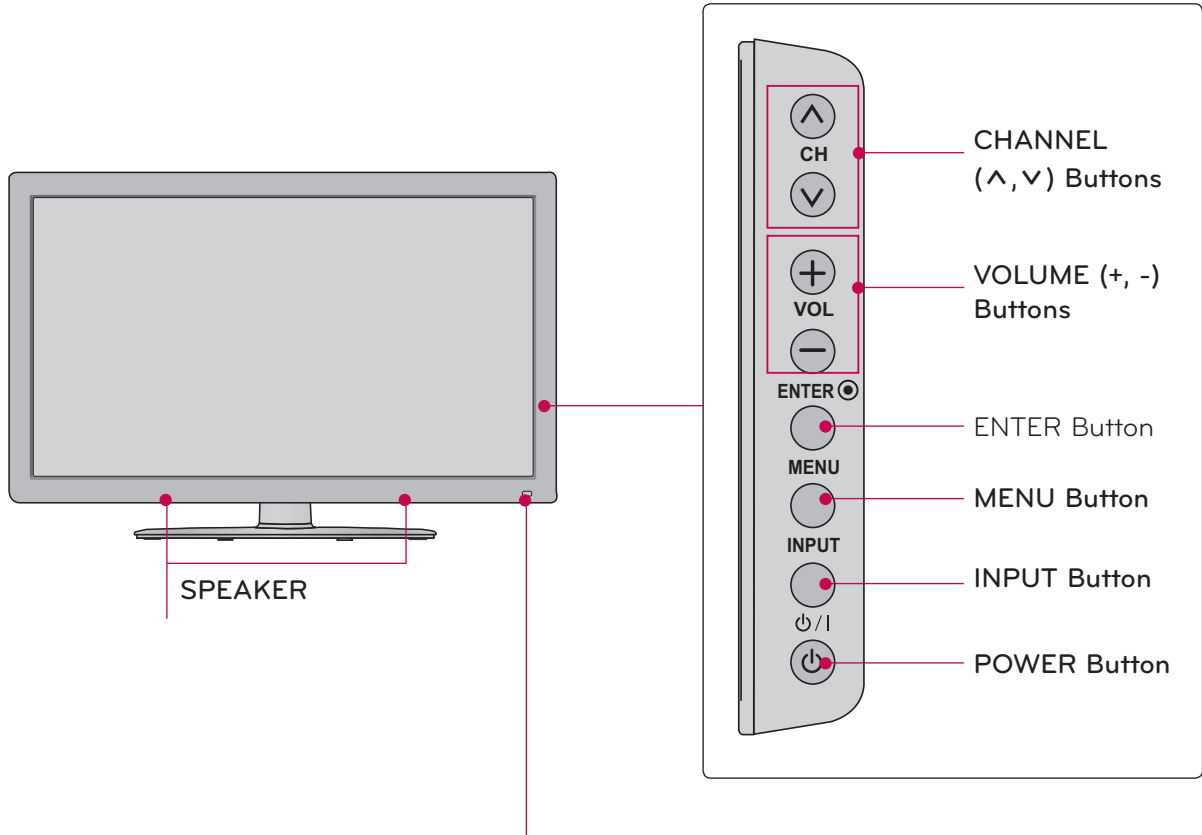

# PREPARATION

■ Image shown may differ from your TV.

## 32/42/47LD420

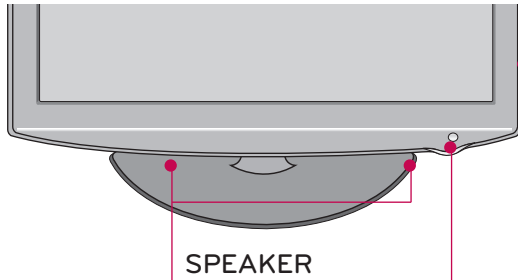

Remote Control Sensor  
 Power/Standby Indicator  
 (Can be adjusted using the **Power Indicator** in the OPTION menu. ▶ p.111)

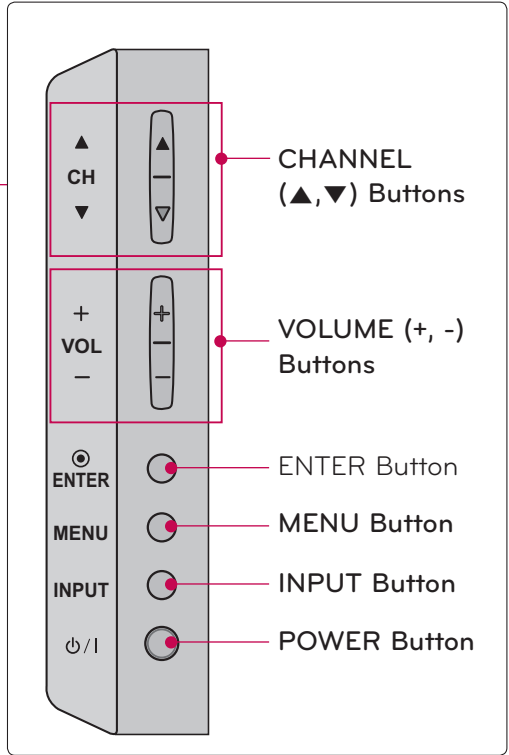

## 32/42/47/55LD520, 55LD520C

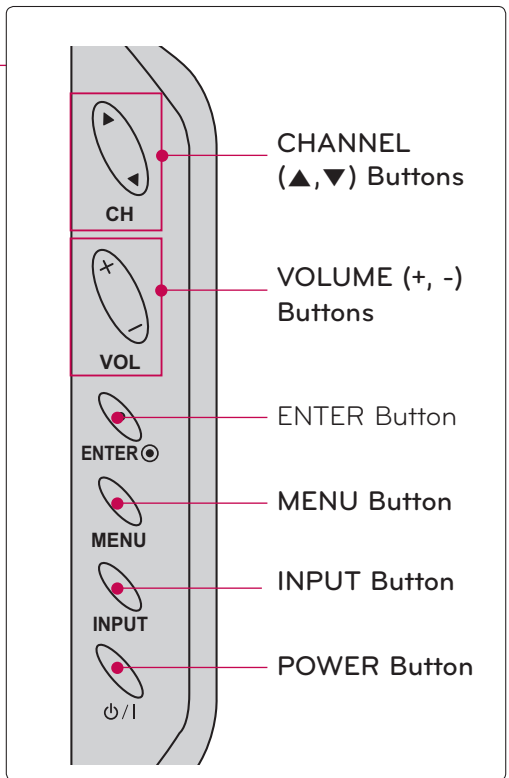
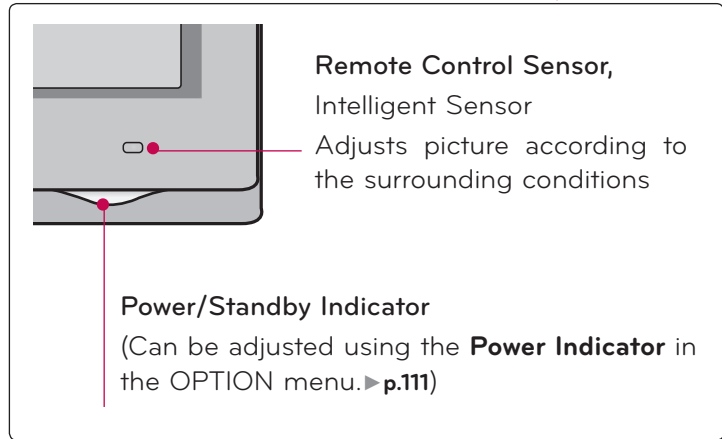
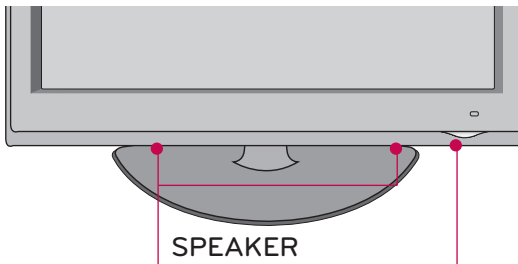

42/47/55LE7300

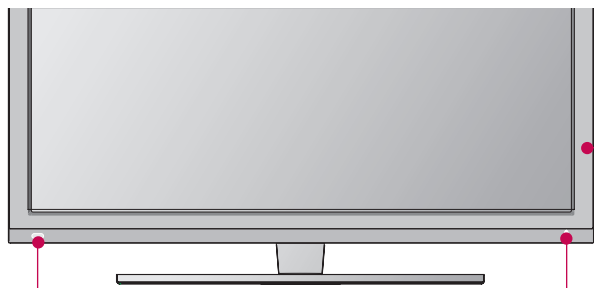

**Power/Standby Indicator**  
 (Can be adjusted using the **Power Indicator** in the **OPTION** menu. ▶ p.111)

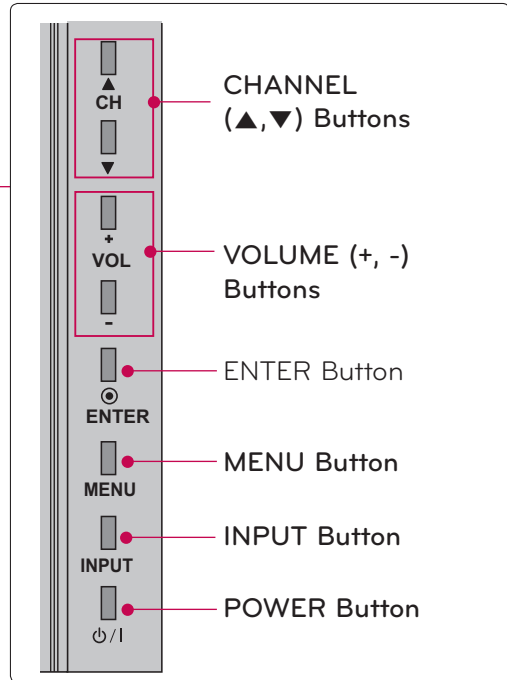

**Remote Control Sensor**



**Intelligent Sensor**  
 Adjusts picture according to the surrounding conditions.

**NOTE**

- ▶ Do not step on the glass stand or subject it to any impact. It may break, causing possible injury from fragments of glass, or the TV may fall.
- ▶ Do not drag the TV. The floor or the product may be damaged.

# PREPARATION

## BACK PANEL INFORMATION

■ Image shown may differ from your TV.

19/22/26LE5300, 22/26LE5500,

PREPARATION

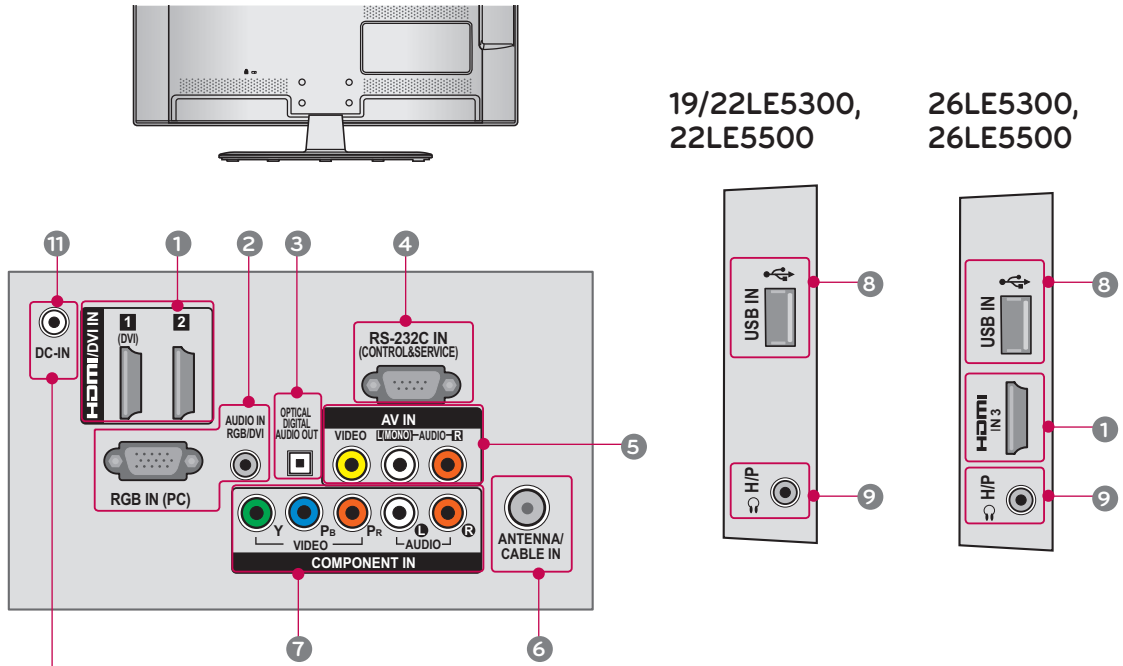

### Power Connection

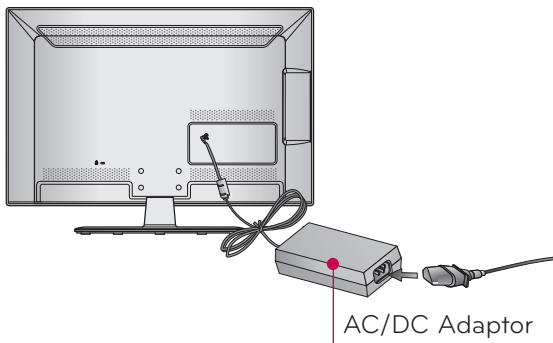

- 1 Connect the AC/DC adapter plug to the power input jack on the TV.
- 2 Connect the power cord to the AC/DC adapter first, then plug the power cord into the wall power outlet.

### ⚠ CAUTION

- ▶ Please be sure to connect the TV to the AC/DC power adapter before connecting the TV's power plug to a wall power outlet.

32/37/42/47/55LE5300, 42/47/55LE530C

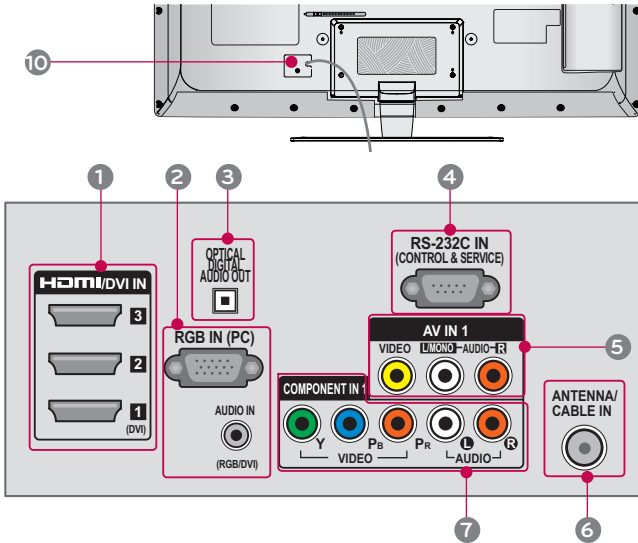

42/47/55LE7300

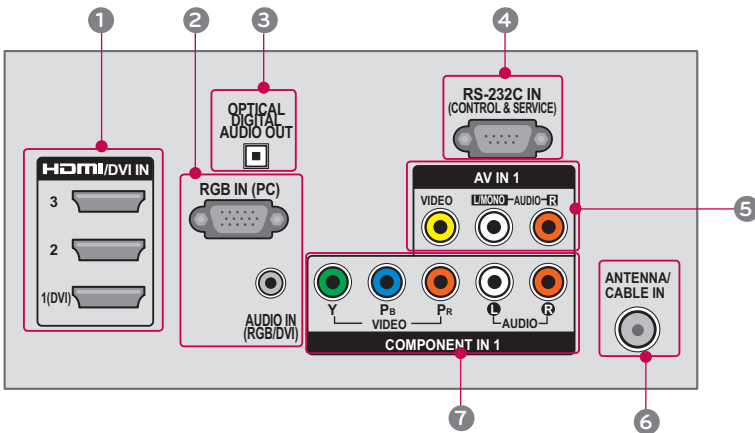

**! CAUTION**

**For HDMI IN 4 and USB IN**

- ▶ For an optimal connection, HDMI cables and USB devices should have bezels less than 10 mm (0.39 inches) thick.

\*A ≤ 10 mm (0.39 inches)

# PREPARATION

PREPARATION

32/42/47LD420, 32/37/42/47LD450, 42/47LD451C

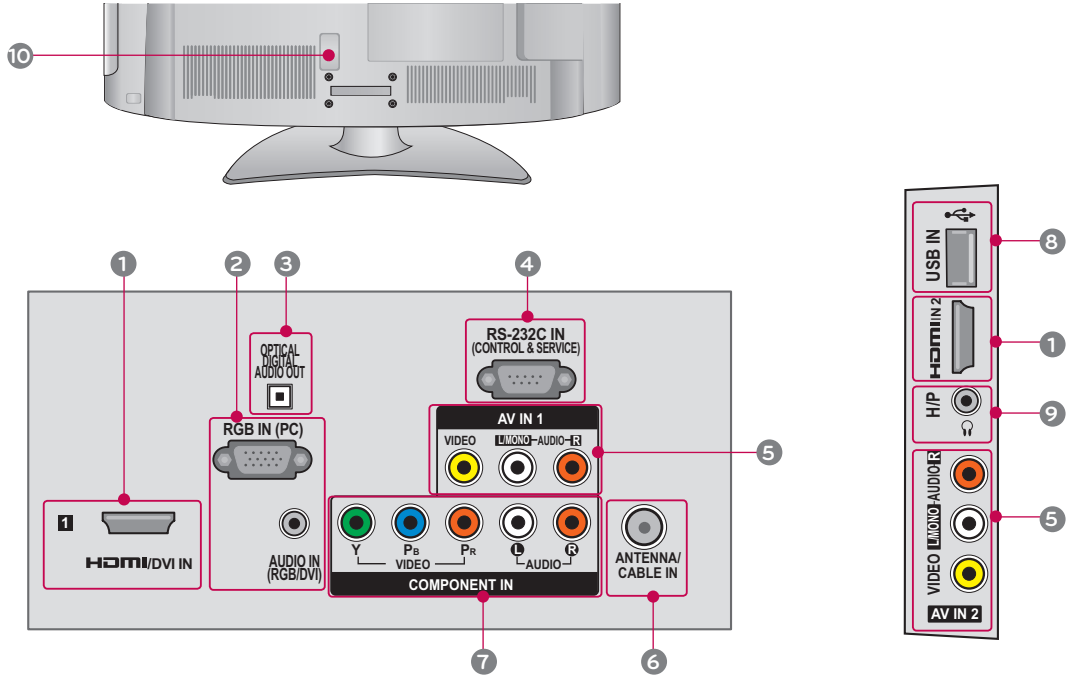

32/42/47/55LD520, 55LD520C, 42/47/55LD630

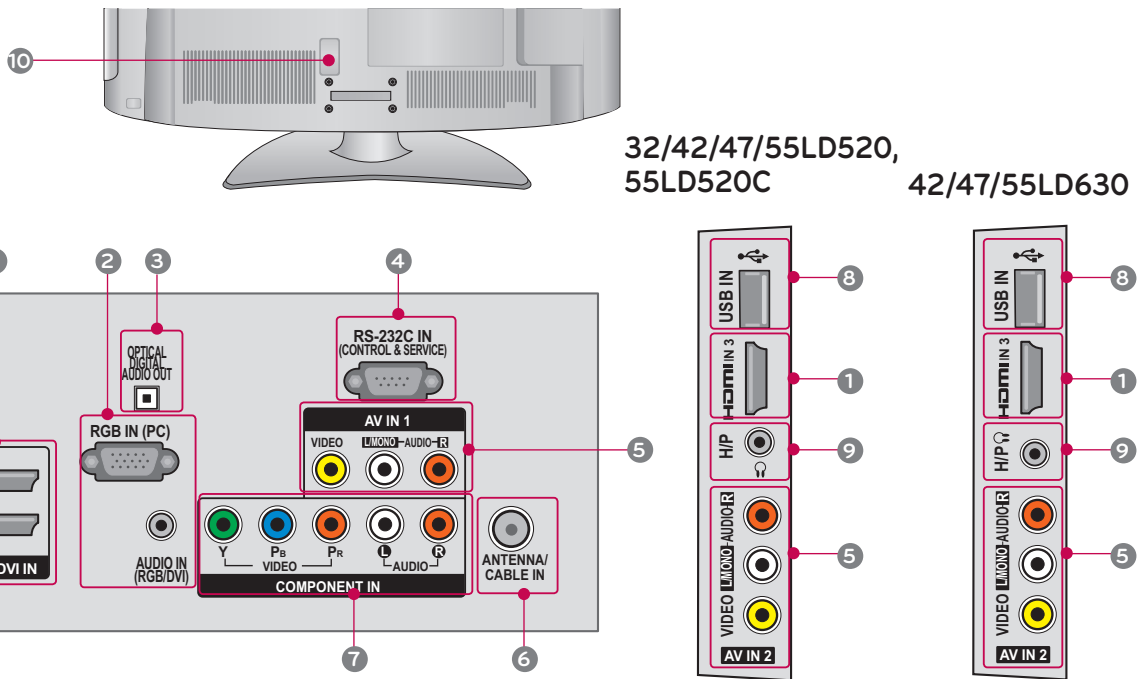

37/42/47LD450C, 32/37/42/47LD452C, 32/42/47LD452B, 26LD352C

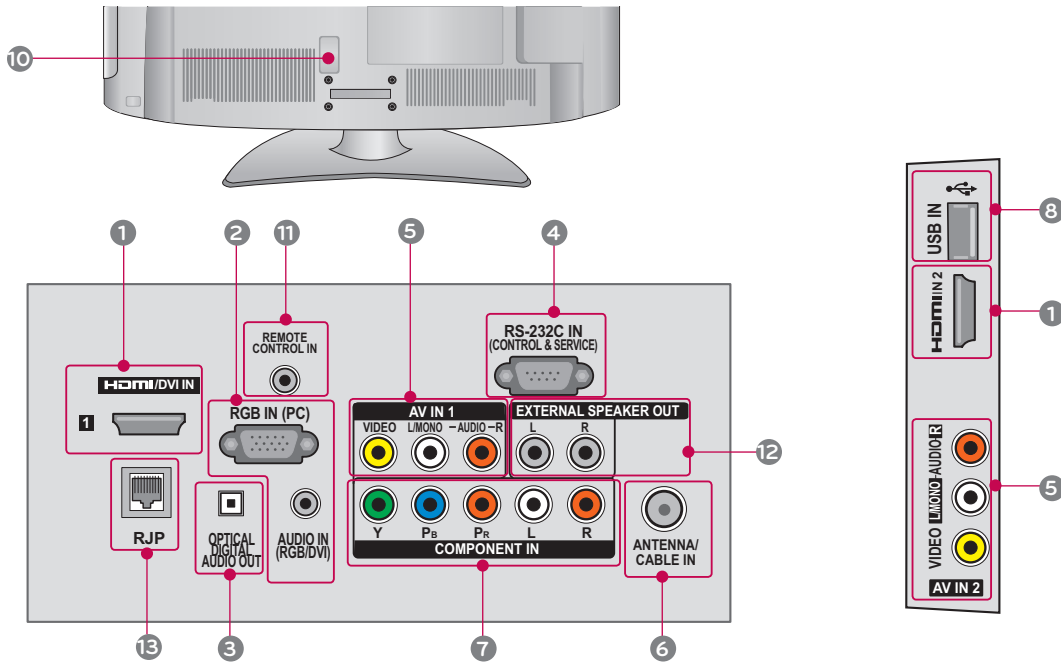

**1 HDMI/DVI IN, HDMI IN**

Digital Connection.

Supports HD video and Digital audio. Doesn't support 480i.

Accepts DVI video using an adapter or HDMI to DVI cable (not included).

**2 RGB IN (PC)**

Analog PC Connection. Uses a D-sub 15 pin cable (VGA cable).

**AUDIO IN (RGB/DVI)**

0.32 cm (1/8 inch) headphone jack for analog PC audio input.

**3 OPTICAL DIGITAL AUDIO OUT**

Digital optical audio output for use with amps and home theater systems.

Note: In standby mode, this port doesn't work.

**4 RS-232C IN (CONTROL & SERVICE)**

Used by third party devices.

This port is used for service or Hotel mode.

**5 AV (Audio/Video) IN**

Analog composite connection. Supports standard definition video only (480i).

**6 ANTENNA/CABLE IN**

Connect over-the-air or cable signals to this jack.

**7 COMPONENT IN**

Analog Connection.

Supports HD.

Uses a red, green, and blue cable for video & red and white for audio.

**8 USB INPUT**

Used for viewing videos, photos and listening to MP3s.

**9 HEADPHONE**

0.32 cm (1/8 inch) headphone jack

Impedance 16 Ω , Maximum audio out 15 mW

**10 Power Cord Socket**

For operation with AC power.

Caution: Never attempt to operate the TV on DC pwer.

**11 REMOTE CONTROL IN**

For a wired remote control.

**12 EXTERNARL SPEAKER OUT**

For use with external speakers.

**13 RJP**

Connect this to an LG remote jack pack system.

# PREPARATION

## STAND INSTRUCTIONS (For 19/22LE5300, 22LE5500)

■ Image shown may differ from your TV.

PREPARATION

### INSTALLATION

- 1 Carefully place the TV screen side down on a cushioned surface to protect the screen from damage.

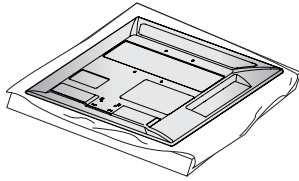

- 2 Assemble the parts of the **STAND BODY** with the **STAND BASE** of the TV.

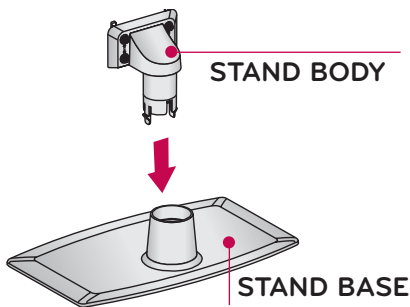

- 3 Assemble the TV as shown.

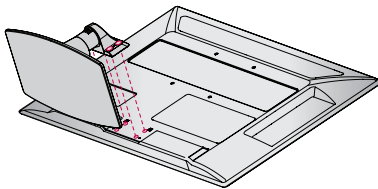

- 4 Install the 4 screws into the holes shown.

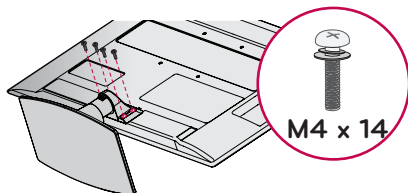

### NOTE

- ▶ When assembling the desk type stand, make sure the screws are fully tightened. (If not tightened fully, the TV can tilt forward after the product installation). Do not over tighten.

### DETACHMENT

- 1 Carefully place the TV screen side down on a cushioned surface to protect the screen from damage.

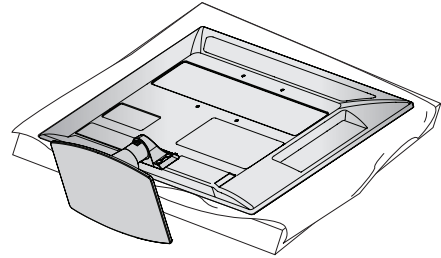

- 2 Remove the screws from the TV.

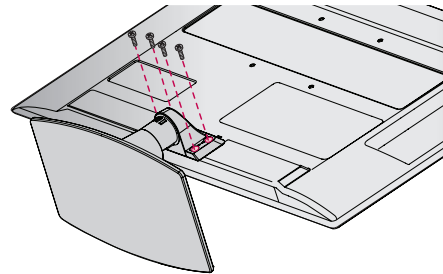

- 3 Detach the stand from TV.

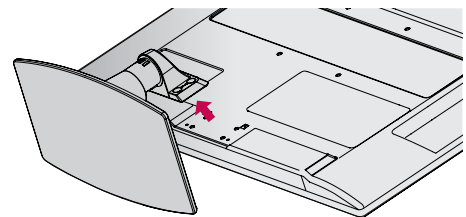

# STAND INSTRUCTIONS (For 42/47/55LE7300)

■ Image shown may differ from your TV.

## INSTALLATION

- 1 Carefully place the TV screen side down on a cushioned surface to protect the screen from damage.

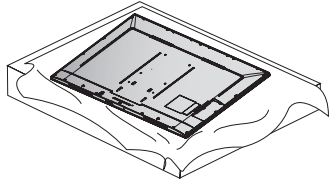

- 2 Assemble the parts of the **STAND BODY** with the **STAND BASE** of the TV.

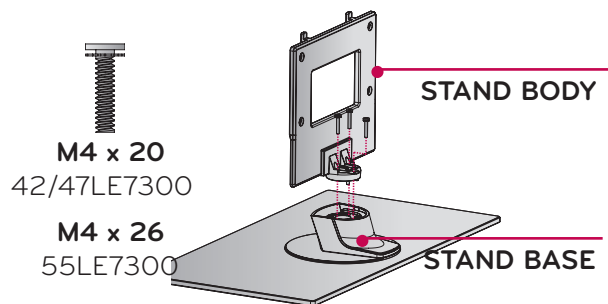

- 3 Assemble the TV as shown.

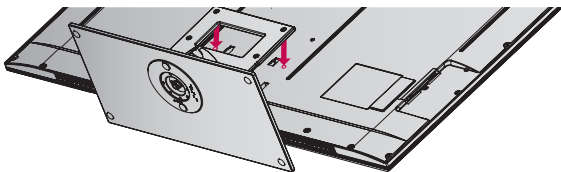

- 4 Install the 4 screws into the holes shown.

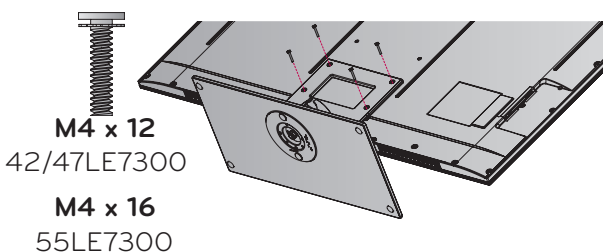

### NOTE

- ▶ When assembling the desk type stand, make sure the screws are fully tightened (If not tightened fully, the TV can tilt forward after the product installation). Do not over tighten.

## DETACHMENT

- 1 Carefully place the TV screen side down on a cushioned surface to protect the screen from damage.

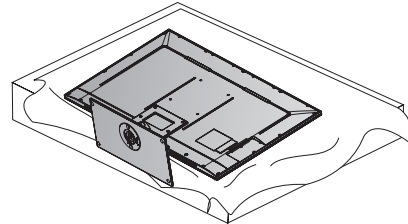

- 2 Remove the screws from the TV.

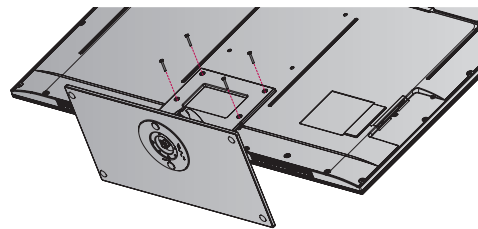

- 3 Detach the stand from TV.

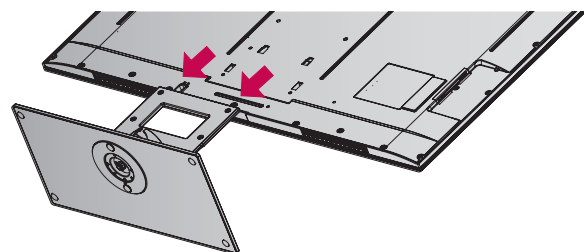

# PREPARATION

## STAND INSTRUCTIONS

(For 26/32/37/42/47/55LE5300, 26LE5500, 42/47/55LE530C)

■ Image shown may differ from your TV.

PREPARATION

### INSTALLATION

**1** Carefully place the TV screen side down on a cushioned surface to protect the screen from damage.

**2** Assemble the parts of the **STAND BODY** with the **STAND BASE** of the TV.



26LE5300,  
26LE5500



32LE5300



37/42LE5300,  
42LE530C



47/55LE5300,  
47/55LE530C

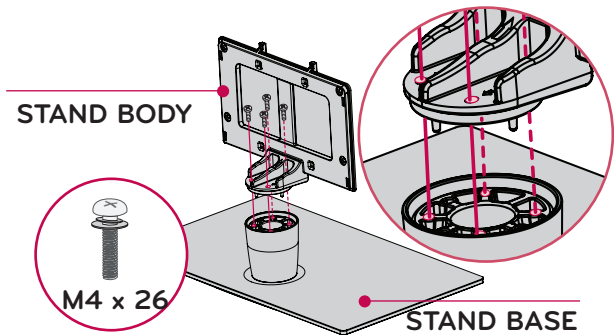

**3** Assemble the TV as shown.

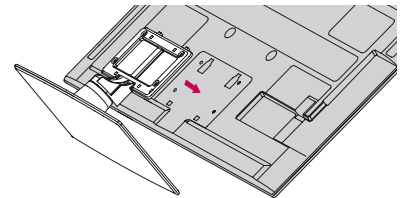

**4** Assemble the part of the **STAND REAR COVER** with the TV.

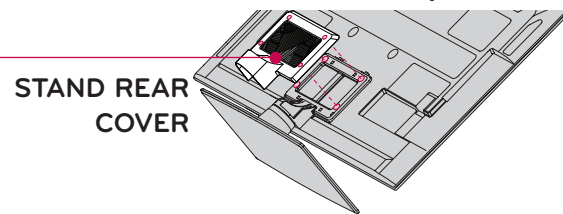

**5** Install the 4 screws into the holes shown.  
or

(For 42/47/55LE530C)

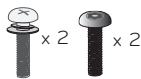

Tighten the two of these four screws and the two Torx plus star head screws (provided as parts of the TV) to secure the TV. Tighten the two Torx plus star head screws with a star head driver bit (not provided as parts of the TV).



26LE5300,  
26LE5500

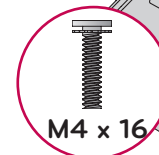

Other models

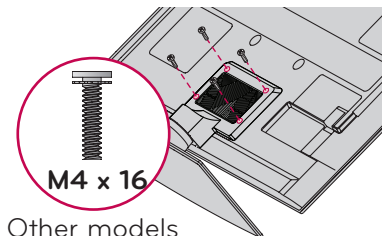

### NOTE

- ▶ When assembling the desk type stand, make sure the screws are fully tightened (If not tightened fully, the TV can tilt forward after the product installation). Do not over tighten.

## DETACHMENT

- 1 Carefully place the TV screen side down on a cushioned surface to protect the screen from damage.

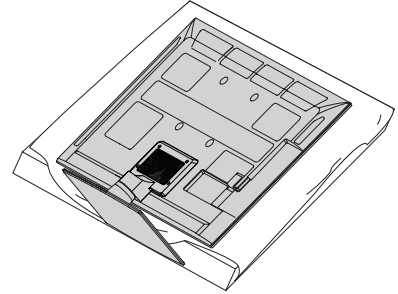

- 2 Remove the screws from the TV.

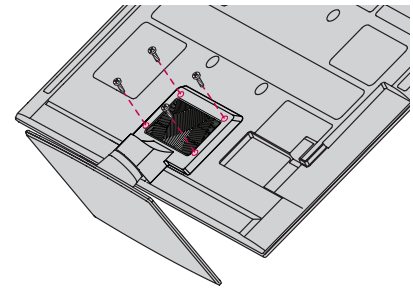

- 3 Detach the **STAND REAR COVER** from TV.

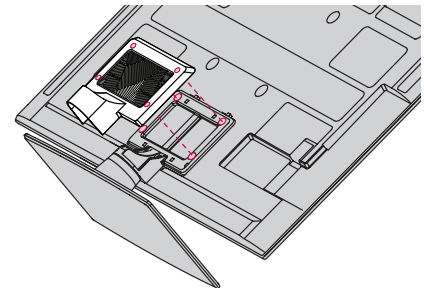

- 4 Detach the stand from TV.

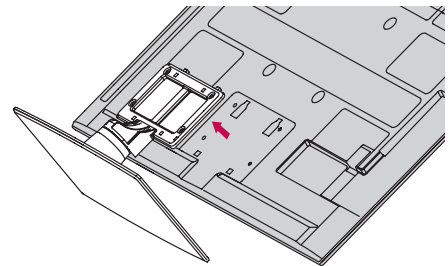

# PREPARATION

## STAND INSTRUCTIONS

(For 32/37/42/47LD450, 37/42/47LD450C, 42/47/55LD630, 42/47LD451C, 32/37/42/47LD452C, 32/42/47LD452B, 26LD352C)

■ Image shown may differ from your TV.

PREPARATION

### INSTALLATION

- 1 Carefully place the TV screen side down on a cushioned surface to protect the screen from damage.

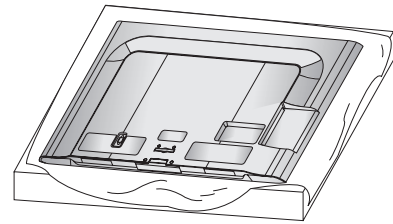

- 2 Assemble the parts of the **STAND BODY** with the **STAND BASE** of the TV.

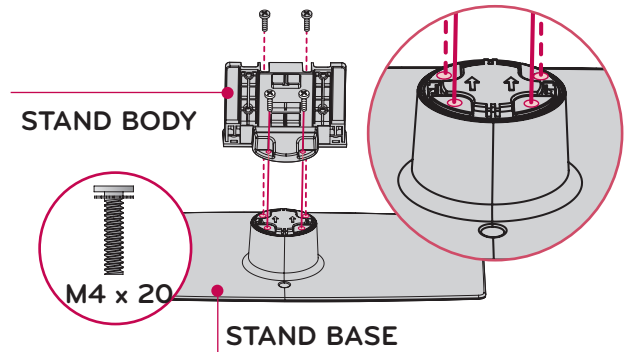

- 3 Assemble the TV as shown.

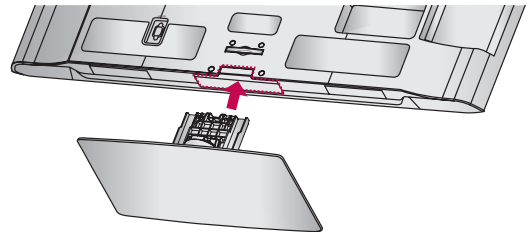

- 4 Install the 4 screws into the holes shown.

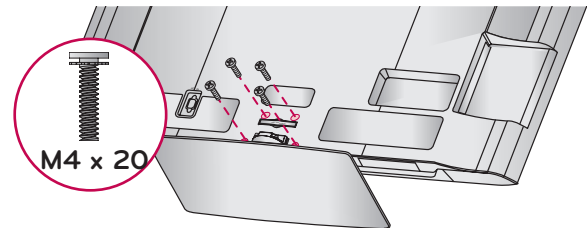

#### NOTE

- ▶ When assembling the desk type stand, make sure the screws are fully tightened (If not tightened fully, the TV can tilt forward after the product installation). Do not over tighten.

## DETACHMENT

- 1 Carefully place the TV screen side down on a cushioned surface to protect the screen from damage.

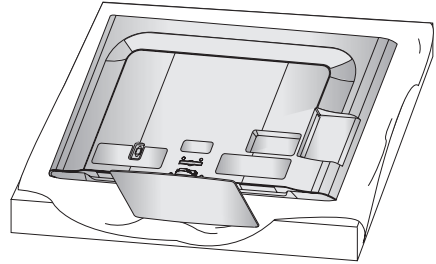

- 2 Remove the screws from the TV.

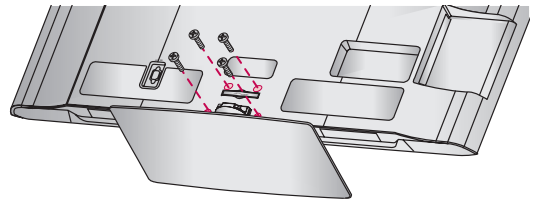

- 3 Detach the stand from TV.

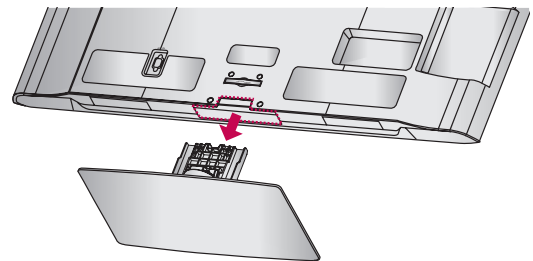

## PROTECTION COVER

After removing the stand, install the included **PROTECTION COVER** over the hole for the stand.

Press the **PROTECTION COVER** into the TV until you hear it click.

When installing the wall mounting bracket, use the **PROTECTION COVER**.

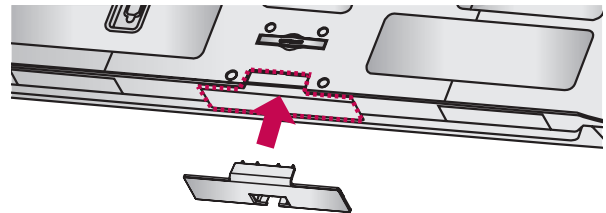

# PREPARATION

## STAND INSTRUCTIONS

(For 32/42/47LD420, 32/42/47/55LD520, 55LD520C)

■ Image shown may differ from your TV.

PREPARATION

### INSTALLATION

- 1 Carefully place the TV screen side down on a cushioned surface to protect the screen from damage.
- 2 (For 55LD520C, 55LD520)  
Assemble the parts of the **STAND BODY** with the **STAND BASE** of the TV.
- 3 Assemble the TV as shown.
- 4 Install the 4 screws into the holes shown.

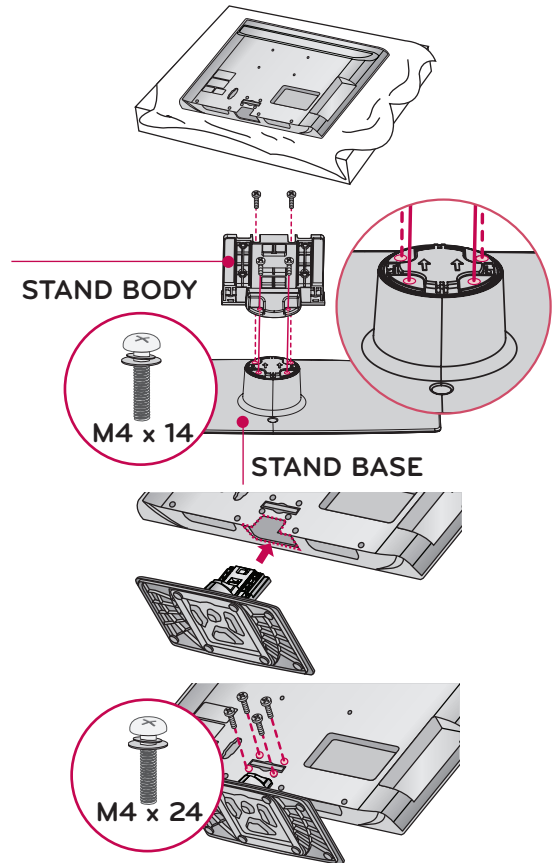

For 55LD520C

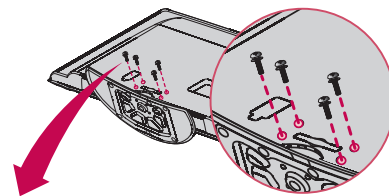

Tighten the stand with the four screws (provided as parts of the TV).

or

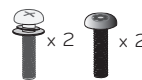

Tighten the two of these four screws and the two Torx plus star head screws (provided as parts of the TV) to secure the TV. Tighten the two Torx plus star head screws with a star head driver bit (not provided as parts of the TV).

### NOTE

- ▶ When assembling the desk type stand, make sure the screws are fully tightened (If not tightened fully, the TV can tilt forward after the product installation). Do not over tighten.

■ Image shown may differ from your TV.

## DETACHMENT

- 1 Carefully place the TV screen side down on a cushioned surface to protect the screen from damage.

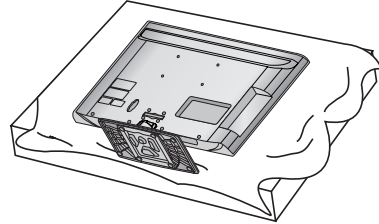

- 2 Remove the screws from the TV.

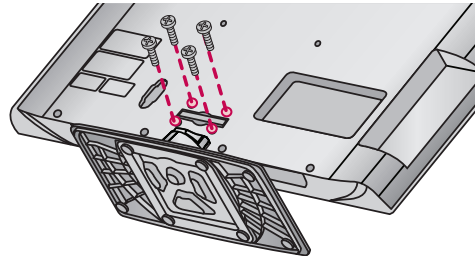

- 3 Detach the stand from TV.

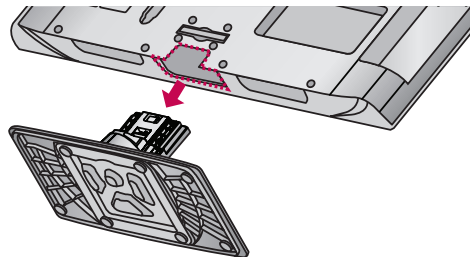

## PROTECTION COVER

After removing the stand, install the included **PROTECTION COVER** over the hole for the stand.

Press the **PROTECTION COVER** into the TV until you hear it click.

When installing the wall mounting bracket, use the **PROTECTION COVER**.

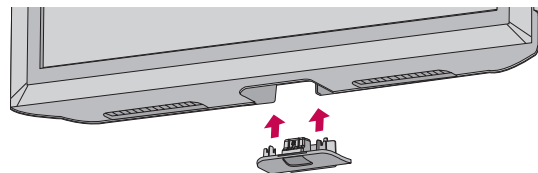

# PREPARATION

## VESA WALL MOUNTING

Install your wall mount on a solid wall perpendicular to the floor. When attaching to other building materials, please contact your nearest installer.

If installed on a ceiling or slanted wall, it may fall and result in severe personal injury.

We recommend that you use an LG brand wall mount when mounting the TV to a wall.

LG recommends that wall mounting be performed by a qualified professional installer.

PREPARATION

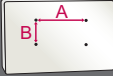
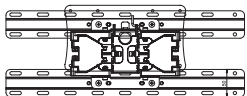
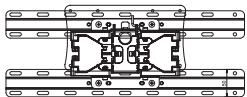
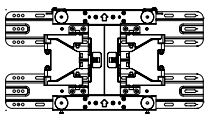
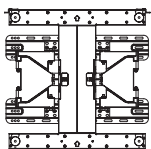
Model	VESA (A * B) 	Standard Screw	Quantity	Wall Mounting Bracket (sold separately)
19LE5300, 22LE5300, 22LE5500, 26LE5300, 26LE5500	100 * 100	M4	4	LSW100B, LSW100BG 
32LE5300, 32LD420, 32LD450, 32LD520, 32LD452C, 32LD452B, 26LD352C	200 * 100	M4	4	LSW100B, LSW100BG 
37LE5300, 37LD450, 37LD450C, 37LD452C, 42LE5300, 42LE530C, 42LE7300, 42LD450, 42LD450C, 42LD420, 42LD520, 42LD630, 42LD451C, 42LD452C, 42LD452B, 47LE5300, 47LE530C, 47LE7300, 47LD450, 47LD450C, 47LD420, 47LD520, 47LD630, 47LD451C, 47LD452C, 47LD452B	200 * 200	M6	4	LSW200B, LSW200BG 
55LE5300, 55LE530C, 55LE7300, 55LD520, 55LD520C, 55LD630	400 * 400	M6	4	LSW400B, LSW400BG, DSW400BG 

**NOTE**

- ▶ Screw length needed depends on the wall mount used. For further information, refer to the instructions included with the mount.
- ▶ Standard dimensions for wall mount kits are shown in the table.
- ▶ When purchasing our wall mount kit, a detailed installation manual and all parts necessary for assembly are provided.
- ▶ Do not use screws longer than the standard dimension, as they may cause damage to the inside to the TV.
- ▶ For wall mounts that do not comply with the VESA standard screw specifications, the length of the screws may differ depending on their specifications.
- ▶ Do not use screws that do not comply with the VESA standard screw specifications.
- ▶ Do not use fasten the screws too strongly, this may damage the TV or cause the TV to a fall, leading to personal injury. LG is not liable for these kinds of accidents.
- ▶ LG is not liable for TV damage or personal injury when a non-VESA or non specified wall mount is used or the consumer fails to follow the TV installation instructions.

**CAUTION**

- ▶ Do not install your wall mount kit while your TV is turned on. It may result in personal injury due to electric shock.

**For 26LE5300, 26LE5500**

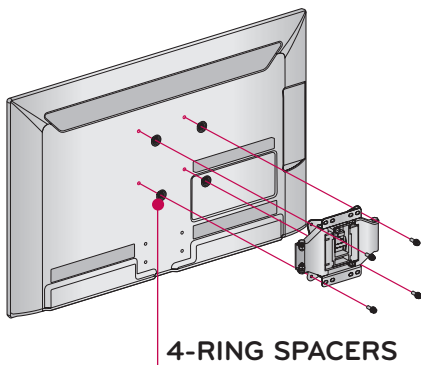

Place the ring spacers on the set before installing the wall mounting bracket so that the inclination of the backside of the set can be adjusted perpendicularly.

# PREPARATION

## CABLE MANAGEMENT

■ Image shown may differ from your TV.

32/37/42/47LD450, 37/42/47LD450C, 32/42/47LD420, 32/42/47/55LD520, 55LD520C, 42/47/55LD630, 42/47LD451C, 32/37/42/47LD452C, 32/42/47LD452B, 26LD352C

PREPARATION

**1** Connect the cables as necessary.

To connect additional equipment, see the **EXTERNAL EQUIPMENT SETUP** section.

For 37/42/47LD450C, 55LD520C, 32/37/42/47LD452C, 32/42/47LD452B, 26LD352C:

Secure the power cord with the **PROTECTIVE BRACKET/SCREW** on the TV back cover. It will help prevent the power cable from being removed by accident.

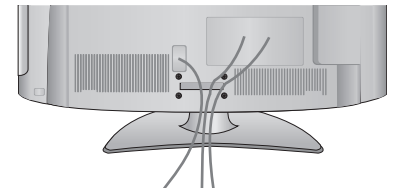
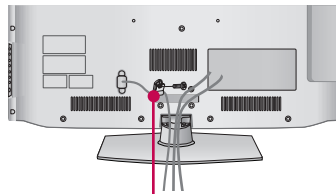
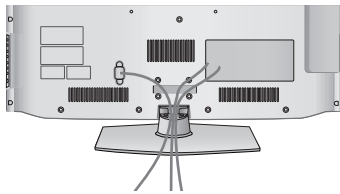

PROTECTIVE BRACKET/SCREW

**2** Open the **CABLE MANAGEMENT CLIP** as shown.

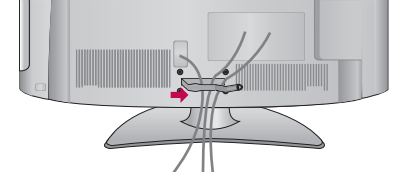
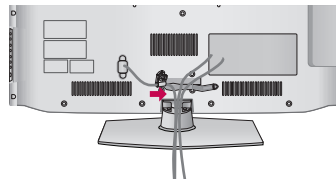
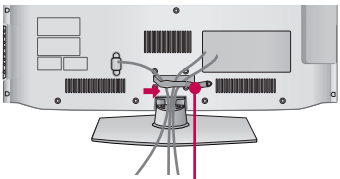

CABLE MANAGEMENT CLIP

**3** Put the cables inside the **CABLE MANAGEMENT CLIP** and snap it closed.

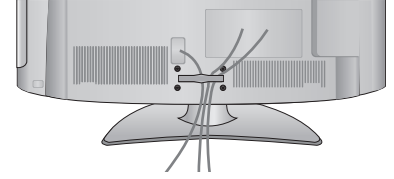
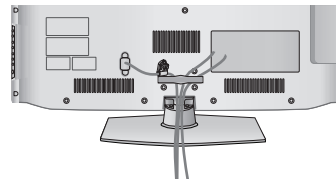
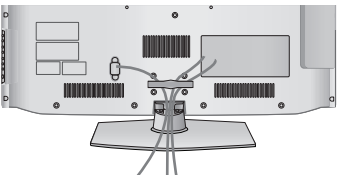

19/22/26LE5300, 22/26LE5500

- 1 After connecting the cables as necessary, install the **CABLE HOLDER** as shown and bundle the cables.

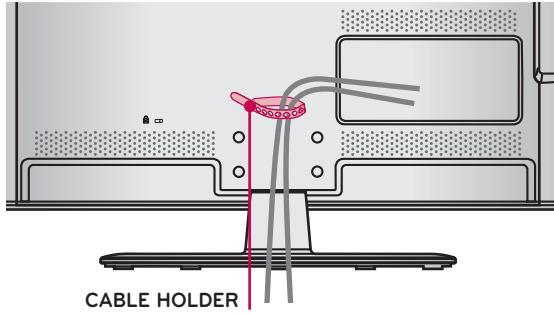

32/37/42/47/55LE5300, 42/47/55LE530C

- 1 Secure the power cord with the **CABLE HOLDER** on the TV back cover. It will help prevent the power cable from being removed by accident.

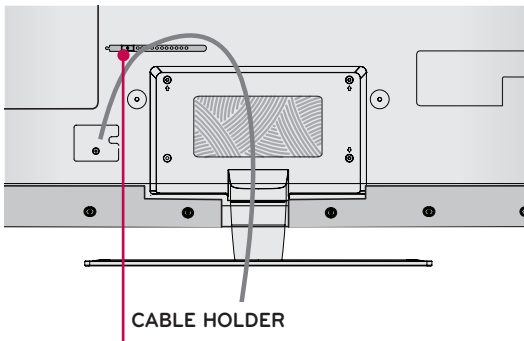

- 2 After connecting the cables as necessary, install the **CABLE HOLDER** as shown and bundle the cables.

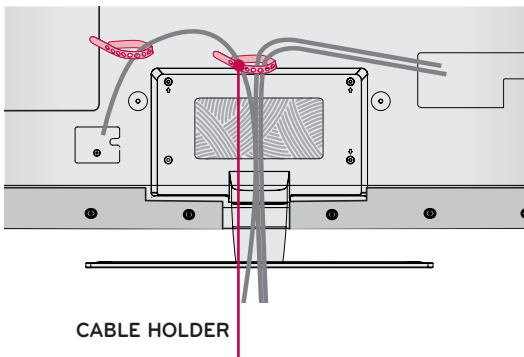

42/47/55LE7300

FOR DESK-TYPE STAND

- 1 Install the **CABLE MANAGEMENT CLIP** as shown.

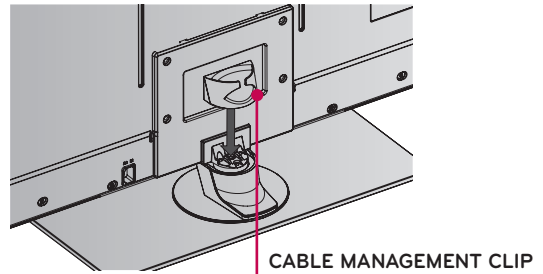

- 2 Connect the cables as necessary. To connect additional equipment, see the **EXTERNAL EQUIPMENT SETUP** section.

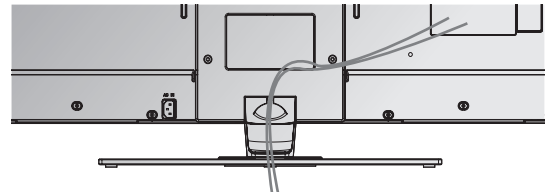

FOR WALL MOUNT

- 1 Connect the cables as necessary. To connect additional equipment, see the **EXTERNAL EQUIPMENT SETUP** section. Install **CABLE HOLDER** as shown and bundle the cables.

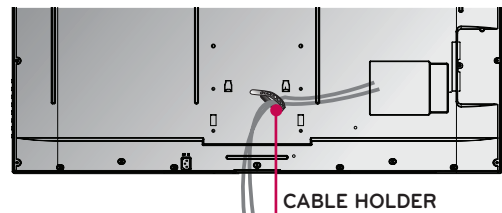

# PREPARATION

## DESKTOP PEDESTAL INSTALLATION

- Image shown may differ from your TV.

For proper ventilation, allow a clearance of 10.1 cm (4 inch) on all four sides from the wall.

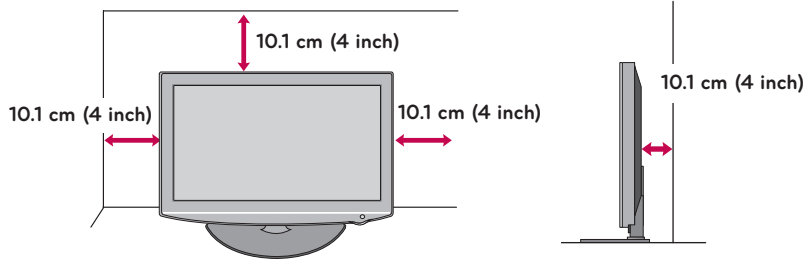

### ⚠ CAUTION

- ▶ Ensure adequate ventilation by following the clearance recommendations.
- ▶ Do not mount near or above any type of heat source.

## SWIVEL STAND (Except 19/22LE5300, 22LE5500)

After installing the TV, you can adjust the TV set manually to the left or right direction by 20 ° to suit your viewing position.

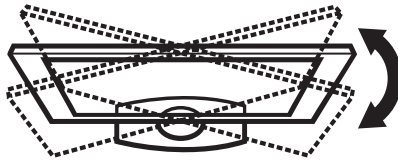

## KENSINGTON SECURITY SYSTEM

- This feature is not available for all models.

- The TV is equipped with a Kensington Security System connector on the back panel. Connect the Kensington Security System cable as shown below.
- For the detailed installation and use of the Kensington Security System, refer to the user's guide provided with the Kensington Security System.

For further information, contact <http://www.kensington.com>, the internet homepage of the Kensington company. Kensington sells security systems for expensive electronic equipment such as notebook PCs and LCD projectors.

NOTE: The Kensington Security System is an optional accessory.

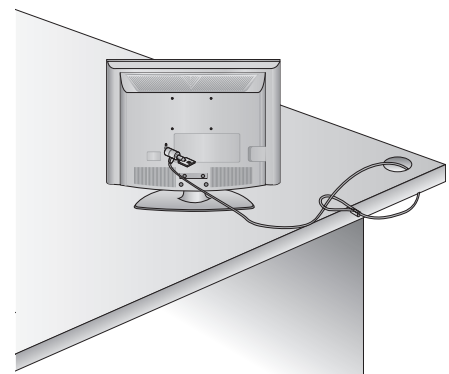

# ATTACHING THE TV TO A DESK

(For 32/42LD420, 32/37/42LD450, 37/42LD450C, 32/42LD520, 42LD630, 32LE5300, 42LD451C, 32/37/42LD452C, 32/42LD452B, 26LD352C)

■ Image shown may differ from your TV.

The TV must be attached to a desk so it cannot be pulled in a forward/backward direction, potentially causing injury or damaging the product.

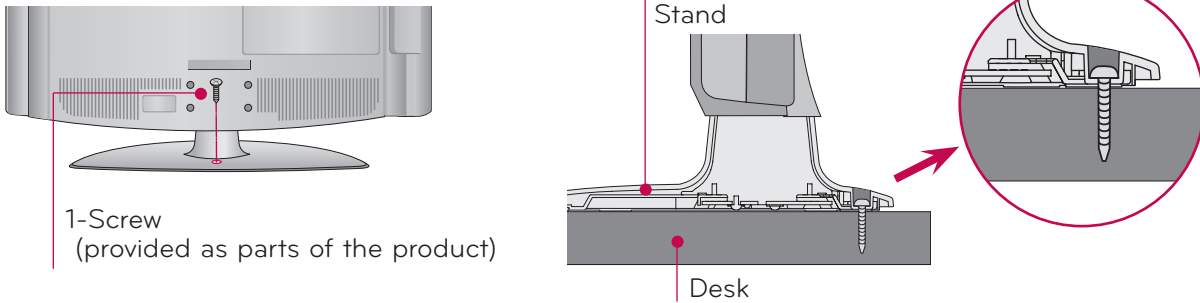

For 37/42/47LD450C, 32/37/42/47LD452C, 32/42/47LD452B, 26LD352C

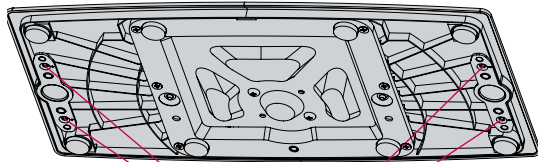

4-Screws  
(not provided as parts of the product)

For 55LD520C

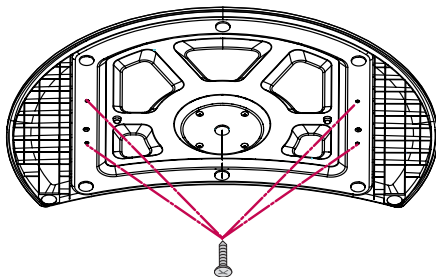

4-Screws  
(not provided as parts of the product)

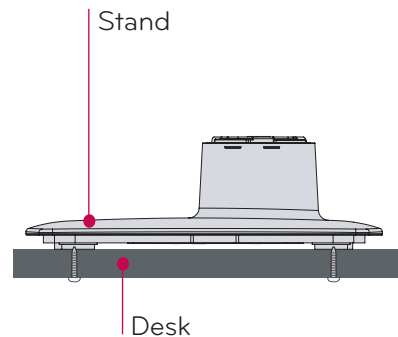

- ▶ Recommended screw size: M5 x L (\*L: Table depth + 8~10 mm)
- ex) Table depth: 15mm, Screw: M5 x 25

## ⚠ WARNING

- ▶ To prevent TV from falling over, the TV should be securely attached to the floor/wall per installation instructions. Tipping, shaking, or rocking the machine may cause injury.

# PREPARATION

## SECURING THE TV TO THE WALL TO PREVENT FALLING WHEN THE TV IS USED ON A STAND

PREPARATION

- You should purchase necessary components to prevent the TV from tipping over (when not using a wall mount).
- Image shown may differ from your TV.

We recommend that you set up the TV close to a wall so it cannot fall over if pushed backwards. Additionally, we recommend that the TV be attached to a wall so it cannot be pulled in a forward direction, potentially causing injury or damaging the product.

Caution: Please make sure that children don't climb on or hang from the TV.

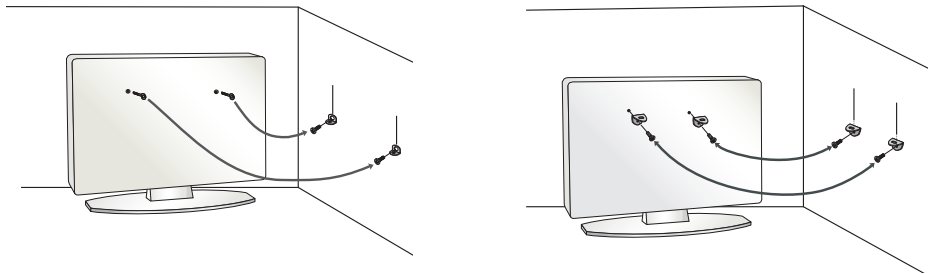

- Insert the eye-bolts (or TV brackets and bolts) to tighten the product to the wall as shown in the picture.
    - \* If your product has the bolts in the eye-bolts position before inserting the eye-bolts, loosen the bolts.
    - \* Insert the eye-bolts or TV brackets/bolts and tighten them securely in the upper holes.
- Secure the wall brackets with the bolts (sold separately) to the wall. Match the height of the bracket that is mounted on the wall to the holes in the product.
- Ensure the eye-bolts or brackets are tightened securely.

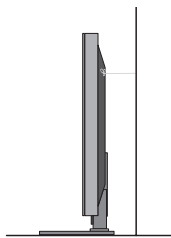

- Use a sturdy rope (sold separately) to tie the product. It is safer to tie the rope so it becomes horizontal between the wall and the product.

### NOTE

- ▶ Use a platform or cabinet strong enough and large enough to support the size and weight of the TV.
- ▶ To use the TV safely make sure that the height of the bracket on the wall and the one on the TV are the same.

- To prevent damage do not connect to the power outlet until all connections are made between the devices.
- Image shown may differ from your TV.

## ANTENNA OR CABLE CONNECTION

### 1. Antenna (Analog or Digital)

Wall Antenna Socket or Outdoor Antenna without a Cable Box Connections.

For optimum picture quality, adjust antenna direction if needed.

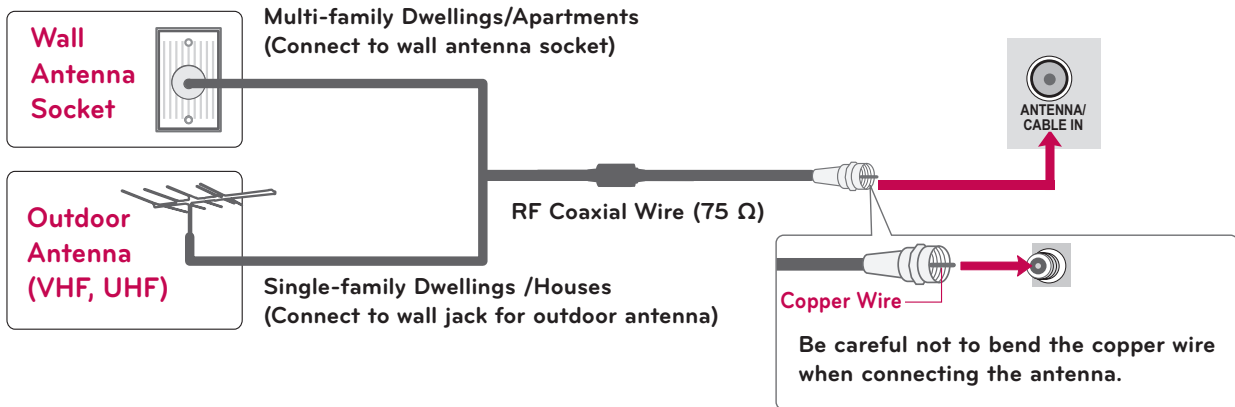

### 2. Cable

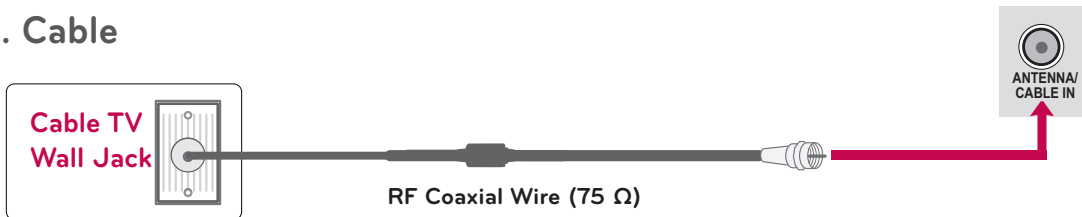

- If the antenna needs to be split for two TV's, install a 2-Way Signal Splitter.
- For much more information about antennas visit our Knowledgebase at <http://lgknowledgebase.com>. Search for antenna.

# EXTERNAL EQUIPMENT SETUP

- To prevent the equipment damage, never plug in any power cords until you have finished connecting all equipment.
- This part of EXTERNAL EQUIPMENT SETUP mainly use picture of for 26LE5300/26LE5500.

## HD RECEIVER SETUP

This TV can receive digital over-the-air/digital cable signals without an external digital set-top box. However, if you do receive digital signals from a digital set-top box or other digital external device.

## Component Connection

### 1. How to connect

- 1 Connect the video outputs (Y, PB, PR) of the digital set-top box to the **COMPONENT IN VIDEO** or **1/2\*** jacks on the TV. Match the jack colors (Y = green, PB = blue, and PR = red).
- 2 Connect the audio output of the digital set-top box to the **COMPONENT IN AUDIO** or **1/2\*** jacks on the TV.

### 2. How to use

- Turn on the digital set-top box.  
(Refer to the owner's manual for the digital set-top box operation.)
- Select the **Component** or **Component1/2\*** input source on the TV using the **INPUT** button on the remote control.

\* Component2: For 32/37/42/47/55LE5300, 42/47/55LE7300, 42/47/55LE530C

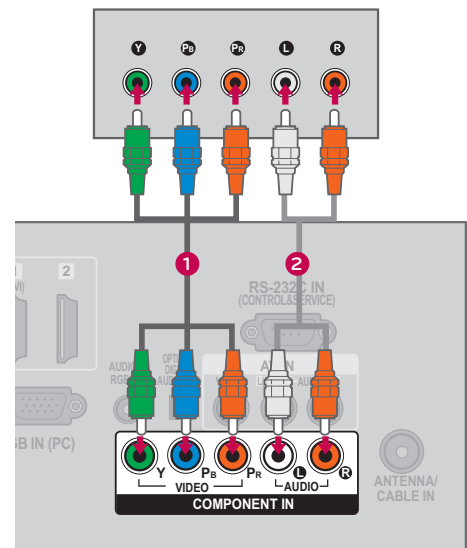

Y, CB/PB, CR/PR

Resolution	Horizontal Frequency(kHz)	Vertical Frequency(Hz)
720x480i	15.73	59.94
	15.73	60.00
720x480p	31.47	59.94
	31.50	60.00
1280x720p	44.96	59.94
	45.00	60.00
1920x1080i	33.72	59.94
	33.75	60.00
1920x1080p	26.97	23.976
	27.00	24.00
	33.71	29.97
	33.75	30.00
	67.432	59.94
	67.50	60.00

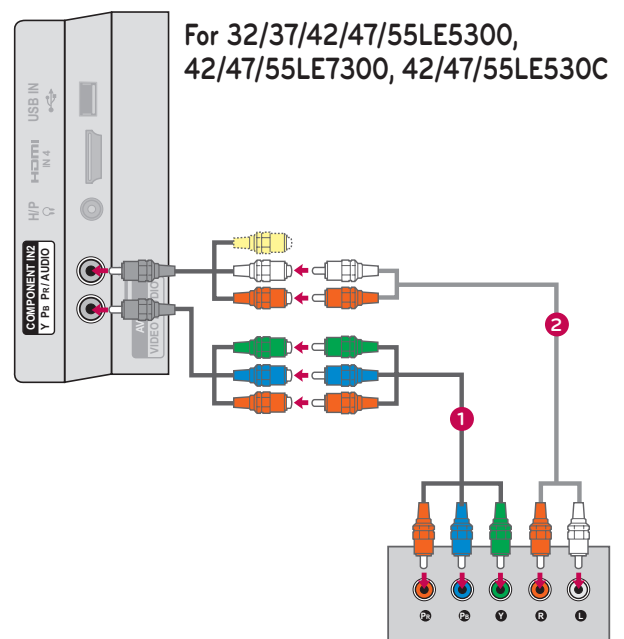

# HDMI Connection

## 1. How to connect

- 1 Connect the digital set-top box to **HDMI/DVI IN 1, 2, 3\***, or **4\*\*** jack on the TV.
- 2 No separate audio connection is necessary. HDMI supports both audio and video.

## 2. How to use

- Turn on the digital set-top box.  
(Refer to the owner's manual for the digital set-top box.)
- Select the **HDMI1, HDMI2, HDMI3\***, or **HDMI4\*\*** input source on the TV using the **INPUT** button on the remote control.

\* HDMI3: For 26LE5300, 26LE5500, 32/42/47/55LD520, 55LD520C, 42/47/55LD630

\*\* HDMI4: For 32/37/42/47/55LE5300, 42/47/55LE7300, 42/47/55LE530C

### NOTE

- ▶ If an HDMI cable doesn't support High Speed HDMI, it can cause flickers or no screen display. In this case use the latest cables that support High Speed HDMI.
- ▶ HDMI Audio Supported Format: Dolby Digital (32 kHz, 44.1 kHz, 48 kHz), Linear PCM (32 kHz, 44.1 kHz, 48 kHz)

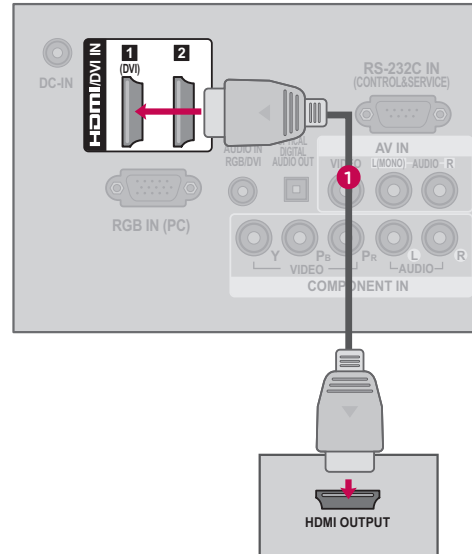

## HDMI-DTV

Resolution	Horizontal Frequency(kHz)	Vertical Frequency(Hz)
720x480p	31.47	59.94
	31.50	60.00
1280x720p	44.96	59.94
	45.00	60.00
1920x1080i	33.72	59.94
	33.75	60.00
1920x1080p	26.97	23.976
	27.00	24.00
	33.71	29.97
	33.75	30.00
	67.432	59.94
	67.50	60.00



# DVD SETUP

## Component Connection

### 1. How to connect

- 1 Connect the video outputs (Y, PB, PR) of the DVD to the **COMPONENT IN VIDEO** or 1/2\* jacks on the TV. Match the jack colors (Y = green, PB = blue, and PR = red).
- 2 Connect the audio outputs of the DVD to the **COMPONENT IN AUDIO** or 1/2\* jacks on the TV.

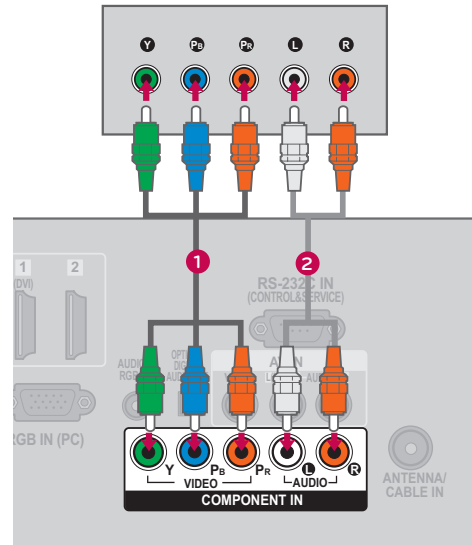

### 2. How to use

- Turn on the DVD player, insert a DVD.
- Select the **Component** or **Component1/2\*** input source on the TV using the **INPUT** button on the remote control.
- Refer to the DVD player's manual for operating instructions.

\* Component2: For 32/37/42/47/55LE5300, 42/47/55LE7300, 42/47/55LE530C

### Component Input ports

To get better picture quality, connect a DVD player to the component input ports as shown below.

Component ports on the TV	Y	P <sub>B</sub>	P <sub>R</sub>
Video output ports on DVD player	Y	P <sub>B</sub>	P <sub>R</sub>
	Y	B-Y	R-Y
	Y	P <sub>b</sub>	P <sub>r</sub>

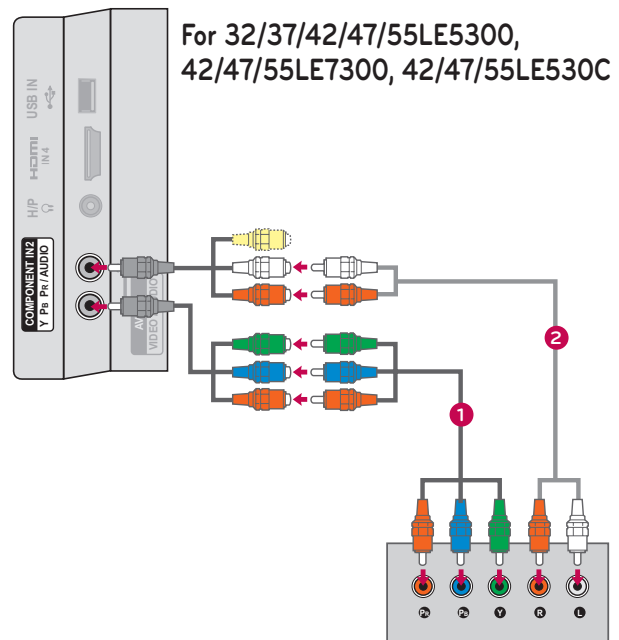

# EXTERNAL EQUIPMENT SETUP

## Composite (RCA) Connection

### 1. How to connect

- 1 Connect the **AUDIO/VIDEO** jacks between TV and DVD. Match the jack colors (Video = yellow, Audio Left = white, and Audio Right = red)

### 2. How to use

- Turn on the DVD player, insert a DVD.
- Select the **AV** or **AV1/2\*** input source on the TV using the **INPUT** button on the remote control.
- Refer to the DVD player's manual for operating instructions.

\* AV2: Except 19/22/26LE5300, 22/26LE5500

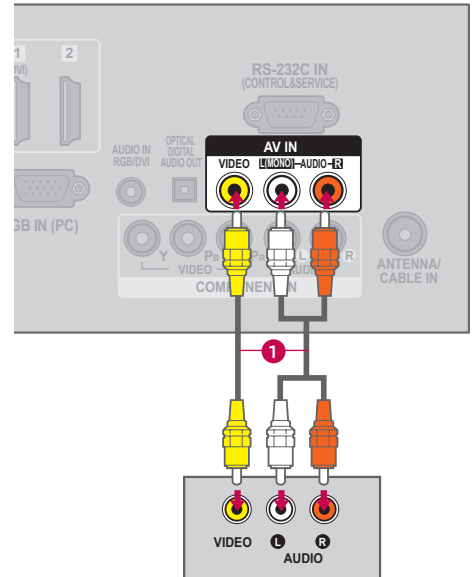

## HDMI Connection

### 1. How to connect

- 1 Connect the HDMI output of the DVD to the **HDMI/DVI IN 1, 2, 3\***, or **4\*\*** jack on the TV.
- 2 No separate audio connection is necessary. HDMI supports both audio and video.

### 2. How to use

- Select the **HDMI1, HDMI2, HDMI3\***, or **HDMI4\*\*** input source on the TV using the **INPUT** button on the remote control.
- Refer to the DVD player's manual for operating instructions.

\* HDMI3: For 26LE5300, 26LE5500, 32/42/47/55LD520, 55LD520C, 42/47/55LD630

\*\* HDMI4: For 32/37/42/47/55LE5300, 42/47/55LE7300, 42/47/55LE530C

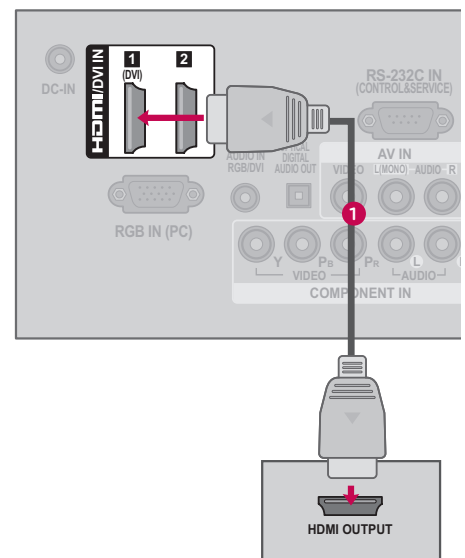

### NOTE

- ▶ If an HDMI cable doesn't support High Speed HDMI, it can cause flickers or no screen display. In this case use the latest cables that support High Speed HDMI.
- ▶ HDMI Audio Supported Format: Dolby Digital (32 kHz, 44.1 kHz, 48 kHz), Linear PCM (32 kHz, 44.1 kHz, 48 kHz)

# VCR SETUP

## Antenna Connection

### 1. How to connect

- 1 Connect the RF antenna out socket of the VCR to the **ANTENNA/CABLE IN** socket on the TV.
- 2 Connect the antenna cable to the RF antenna in socket of the VCR.

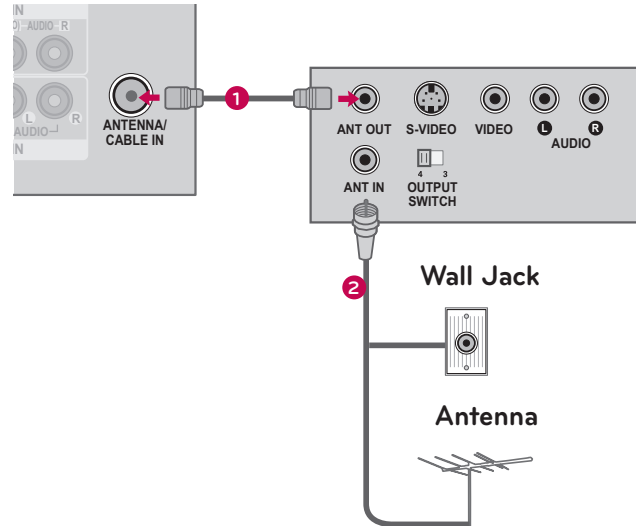

### 2. How to use

- Set VCR output switch to 3 or 4 and then tune TV to the same channel number.
- Insert a video tape into the VCR and press PLAY on the VCR (Refer to the VCR owner's manual).

## Composite (RCA) Connection

### 1. How to connect

- 1 Connect the **AUDIO/VIDEO** jacks between TV and VCR. Match the jack colors (Video = yellow, Audio Left = white, and Audio Right = red)

### 2. How to use

- Insert a video tape into the VCR and press PLAY on the VCR. (Refer to the VCR owner's manual.)
- Select the **AV** or **AV1/2\*** input source on the TV using the **INPUT** button on the remote control.

\* AV2: Except 19/22/26LE5300, 22/26LE5500

#### NOTE

- ▶ If you have a mono VCR, connect the audio cable from the VCR to the **AUDIO L(MONO)** jack of the TV.

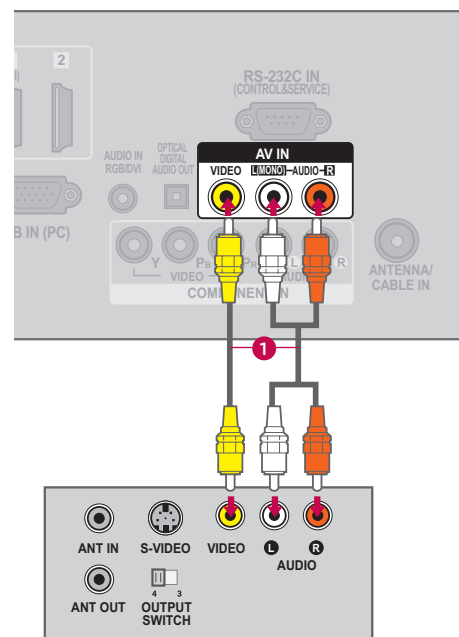

# EXTERNAL EQUIPMENT SETUP

## OTHER A/V SOURCE SETUP

### 1. How to connect

- 1 Connect the **AUDIO/VIDEO** jacks between TV and external equipment. Match the jack colors.  
(Video = yellow, Audio Left = white, and Audio Right = red)

### 2. How to use

- Select the **AV** or **AV1/2\*** input source on the TV using the **INPUT** button on the remote control.
- Operate the corresponding external equipment.

\* AV2: Except 19/22/26LE5300, 22/26LE5500

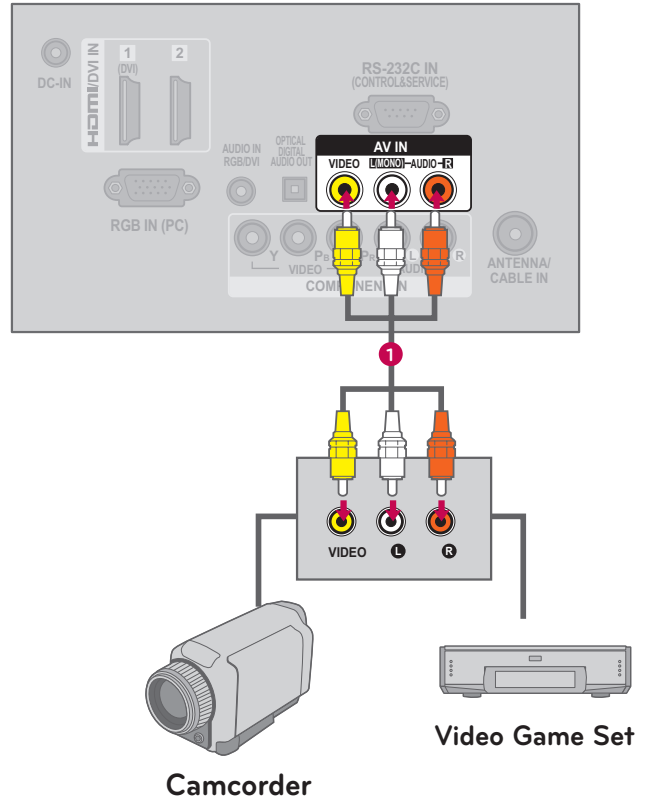

# USB CONNECTION

## 1. How to connect

- 1 Connect the USB device to the **USB IN** jack on the side of TV.

## 2. How to use

- After connecting the **USB IN** jack, you use the USB function. (▶ p.78)

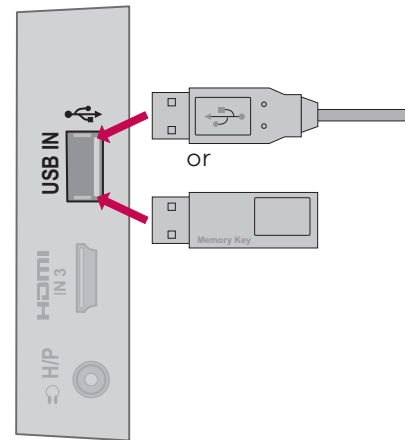

# HEADPHONE SETUP

(Except 37/42/47LD450C, 32/37/42/47LD452C, 32/42/47LD452B, 26LD352C)

You can listen to the sound through the headphone.

## 1. How to connect

- 1 Plug the headphone into the headphone socket.
- 2 To adjust the headphone volume, press the **VOL +/-** button. If you press the **MUTE** button, the sound from the headphone is switched off.

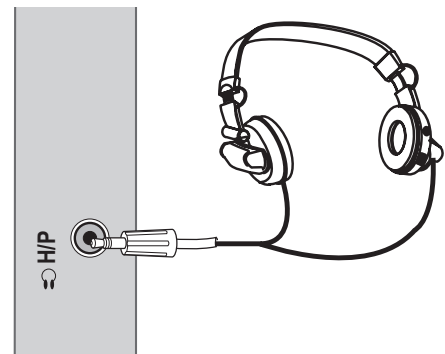

### NOTE

- ▶ AUDIO menu options are disabled when connecting a headphone.
- ▶ When changing AV MODE with a headphone connected, the change is applied to video but not to audio.
- ▶ Optical Digital Audio Out is not available when connecting a headphone.

# EXTERNAL EQUIPMENT SETUP

## AUDIO OUT CONNECTION

Send the TV's audio to external audio equipment via the Audio Output port.

If you want to enjoy digital broadcasting through 5.1-channel speakers, connect the OPTICAL DIGITAL AUDIO OUT terminal on the back of TV to a Home Theater (or amp).

### 1. How to connect

- 1 Connect one end of the optical cable to the TV port of **OPTICAL DIGITAL AUDIO OUT**.
- 2 Connect the other end of the optical cable to the digital audio input on the audio equipment.
- 3 Set the "TV Speaker option - Off" in the AUDIO menu. (▶ p.119). See the external audio equipment instruction manual for operation.

#### NOTE

- ▶ When connecting with external audio equipment, such as amplifiers or speakers, you can turn the TV speakers off in the menu. (▶ p.119)

#### CAUTION

- ▶ Do not look into the optical output port. Looking at the laser beam may damage your vision.
- ▶ Audio with ACP (Audio Copy Protection) function may block digital audio output.

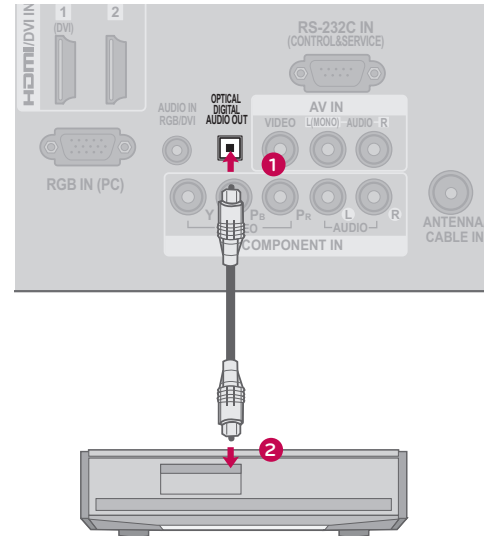

# PC SETUP

This TV provides Plug and Play capability, meaning that a PC adjusts automatically to the TV's settings.

## VGA (D-Sub 15 Pin) Connection

### 1. How to connect

- 1 Connect the VGA output of the PC to the **RGB IN (PC)** jack on the TV.
- 2 Connect PC audio output to the **AUDIO IN (RGB/DVI)** jack on the TV.

### 2. How to use

- Turn on the PC and the TV.
- Select the **RGB-PC** input source on the TV using the **INPUT** button on the remote control.

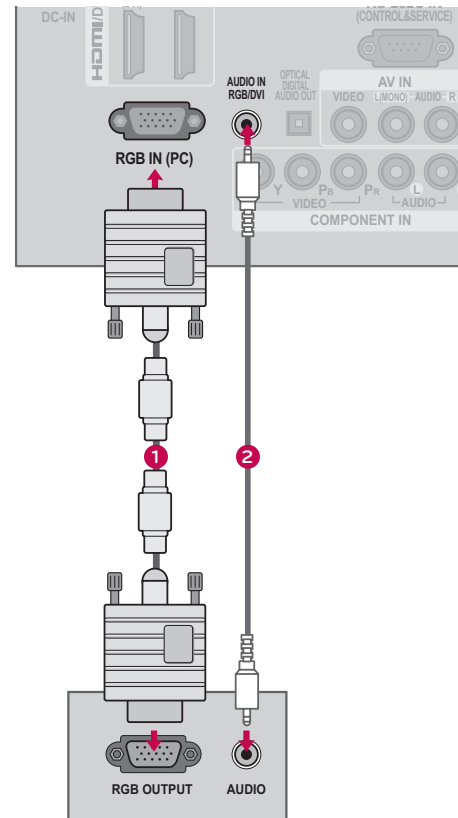

# EXTERNAL EQUIPMENT SETUP

## DVI to HDMI Connection

### 1. How to connect

- 1 Connect the DVI output of the PC to the **HDMI/DVI IN 1** or **2\*** jack on the TV.
- 2 Connect the PC audio output to the **AUDIO IN (RGB/DVI)** jack on the TV.

### 2. How to use

- Turn on the PC and the TV.
- Select the **HDMI1** or **HDMI2\*** input source on the TV using the **INPUT** button on the remote control.

\* HDMI2: For 32/42/47/55LD520, 55LD520C, 42/47/55LD630

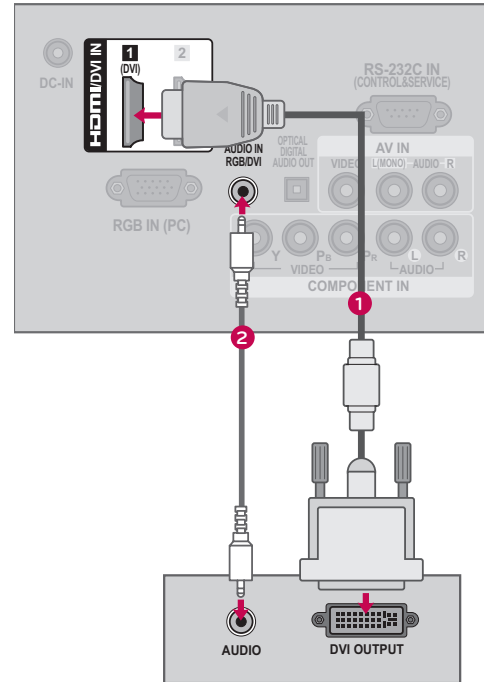

**NOTE**

- ▶ To get the the best picture quality, adjust the PC graphics card to **1360 x 768** (19/22/26LE5300, 22/26LE5500, 32LD452C, 32LD452B, 26LD352C) or **1920 x 1080** (Other models).
- ▶ Depending on the graphics card, DOS mode may not work if a HDMI to DVI Cable is in use.
- ▶ In PC mode, there may be noise associated with the resolution, vertical pattern, contrast or brightness. If noise is present, change the PC output to another resolution, change the refresh rate to another rate or adjust the brightness and contrast on the PICTURE menu until the picture is clear.
- ▶ Avoid keeping a fixed image on the screen for a long period of time. The fixed image may become permanently imprinted on the screen.
- ▶ The synchronization input form for Horizontal and Vertical frequencies is separate.
- ▶ Depending on the graphics card, some resolution settings may not allow the image to be positioned on the screen properly.
- ▶ When selecting HDMI-PC, set the "Input Label - PC" in the OPTION menu.

**Supported Display Specifications (RGB-PC, HDMI-PC)**

Resolution	Horizontal Frequency(kHz)	Vertical Frequency(Hz)
640x350	31.468	70.09
720x400	31.469	70.08
640x480	31.469	59.94
800x600	37.879	60.31
1024x768	48.363	60.00
1280x768	47.776	59.87
1360x768	47.712	60.015
1280x1024	63.981	60.02
1600x1200	75.00	60.00
1920x1080 RGB-PC	66.587	59.934
1920x1080 HDMI-PC	67.50	60.00

Except 19/22/26LE5300,  
22/26LE5500, 32LD452C,  
32LD452B, 26LD352C

Except 32/37/42/47/55LE5300,  
42/47/55LE7300, 42/47/55LE530C

# EXTERNAL EQUIPMENT SETUP

## Screen Setup for PC mode







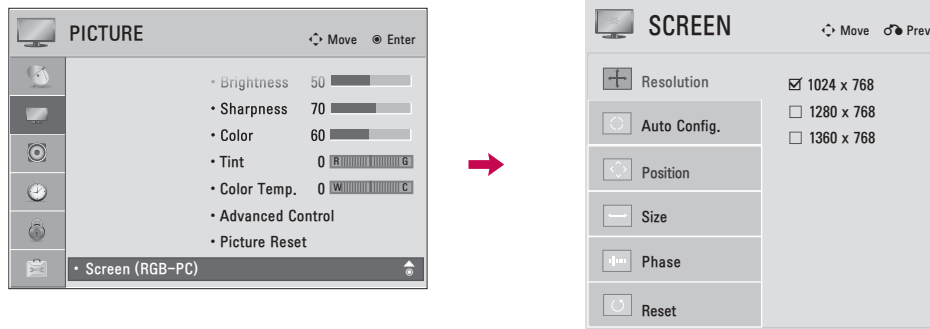

### Selecting Resolution

You can choose the resolution in RGB-PC mode.

The Position, Phase, and Size can also be adjusted.

You can choose this option only when the PC resolution is set to 1024X768, 1280X768 or 1360X768.











- 1   Select **PICTURE**.
- 2   Select **Screen (RGB-PC)**.
- 3   Select **Resolution**.
- 4   Select the desired resolution.
- 5 

## Auto Configure

Automatically adjusts picture position and minimizes image instability. After adjustment, if the image is still not correct, try using the manual settings or a different resolution or refresh rate on the PC.



- 1   Select **PICTURE**.
- 2   Select **Screen (RGB-PC)**.
- 3   Select **Auto Config..**
- 4   Select **Yes**.
- 5  Start Auto Configuration.







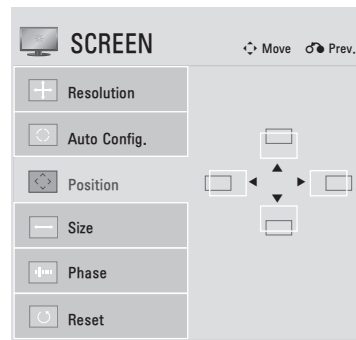
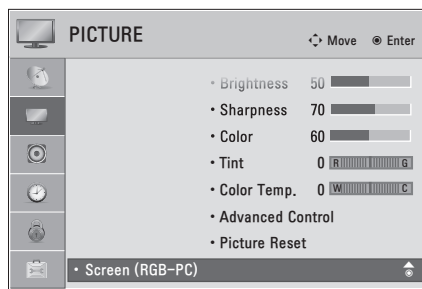

- If the position of the image is still not correct, try Auto adjustment again.
- If picture needs to be adjusted again after Auto adjustment in RGB-PC, you can adjust the **Position**, **Size** or **Phase**.

# EXTERNAL EQUIPMENT SETUP

## Adjustment for screen Position, Size, and Phase

If the picture is not clear after auto adjustment or if text is shaking, adjust the picture phase manually. This feature operates only in RGB-PC mode.











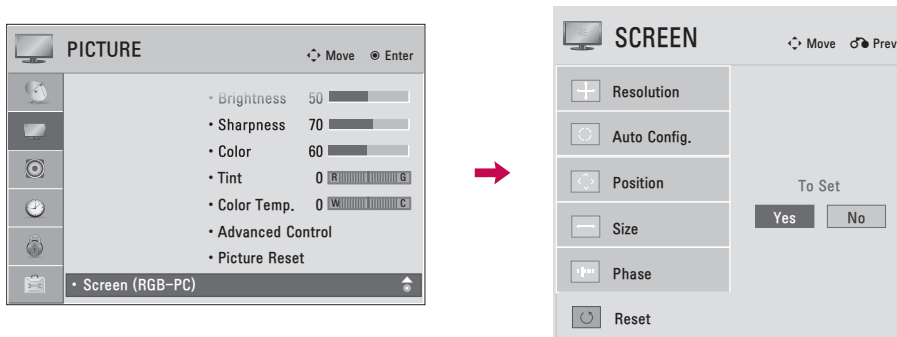

- 1   Select **PICTURE**.
- 2   Select **Screen (RGB-PC)**.
- 3   Select **Position, Size, or Phase**.
- 4   Make appropriate adjustments.
- 5 

- **Position:** This function is to adjust picture to left/right and up/down as you prefer.
- **Size:** This function is to minimize any vertical bars or stripes visible on the screen background. And the horizontal screen size will also change.
- **Phase:** This function allows you to remove any horizontal noise and clear or sharpen the image of characters.

## Screen Reset (Reset to original initial values)

Returns **Position**, **Size**, and **Phase** to the default initial settings.  
This feature operates only in RGB-PC mode.



- 1   Select **PICTURE**.
- 2   Select **Screen (RGB-PC)**.
- 3   Select **Reset**.
- 4   Select **Yes**.
- 5  Start **Reset**.

# WATCHING TV / CHANNEL CONTROL

## REMOTE CONTROL FUNCTIONS

When using the remote control, aim it at the remote control sensor on the TV. The remote control may differ from the images below.



**POWER** Turns the TV on from standby or off to standby.

**ENERGY SAVING** Adjusts the Energy Saving setting. ▶ p.104

**AV MODE** Toggles through preset Video and Audio modes. ▶ p.75

**INPUT** Rotates through inputs. Also switches the TV on from standby. ▶ p.70

**TV** Returns to the last TV channel.

**NUMBER button**

**- (DASH)** Used to enter a program number for multiple program channels such as 5-1, 5-2, etc.

**LIST** Displays the channel table. ▶ p.67

**FLASHBK** Tunes to the last channel viewed.

**VOLUME UP/DOWN** Adjusts the volume.

**FAV** Set up desired favorite channels list ▶ p.66

**MARK** Select the input to apply the Picture Wizard settings. ▶ p.103  
Use to mark or unmark a photo/music/movie. ▶ p.83, 88, 94

**RATIO** Changes the aspect ratio. ▶ p.100

**PORTAL** Displays and removes hotel interactive menu. (Other models)  
Displays the interactive menu, make click on EXIT key if you want to remove the menu window. (For 32/42/47LD452B)

**MUTE** Switches the sound on or off. ▶ p.54

**CHANNEL UP/DOWN** Changes the channel.

**PAGE UP/DOWN** Moves from one full set of screen information to the next one.

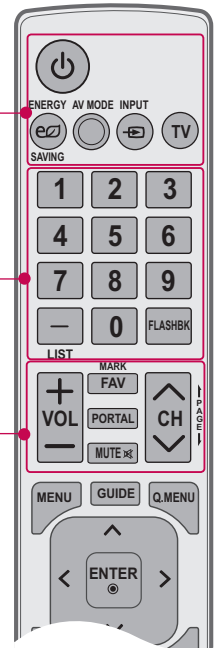

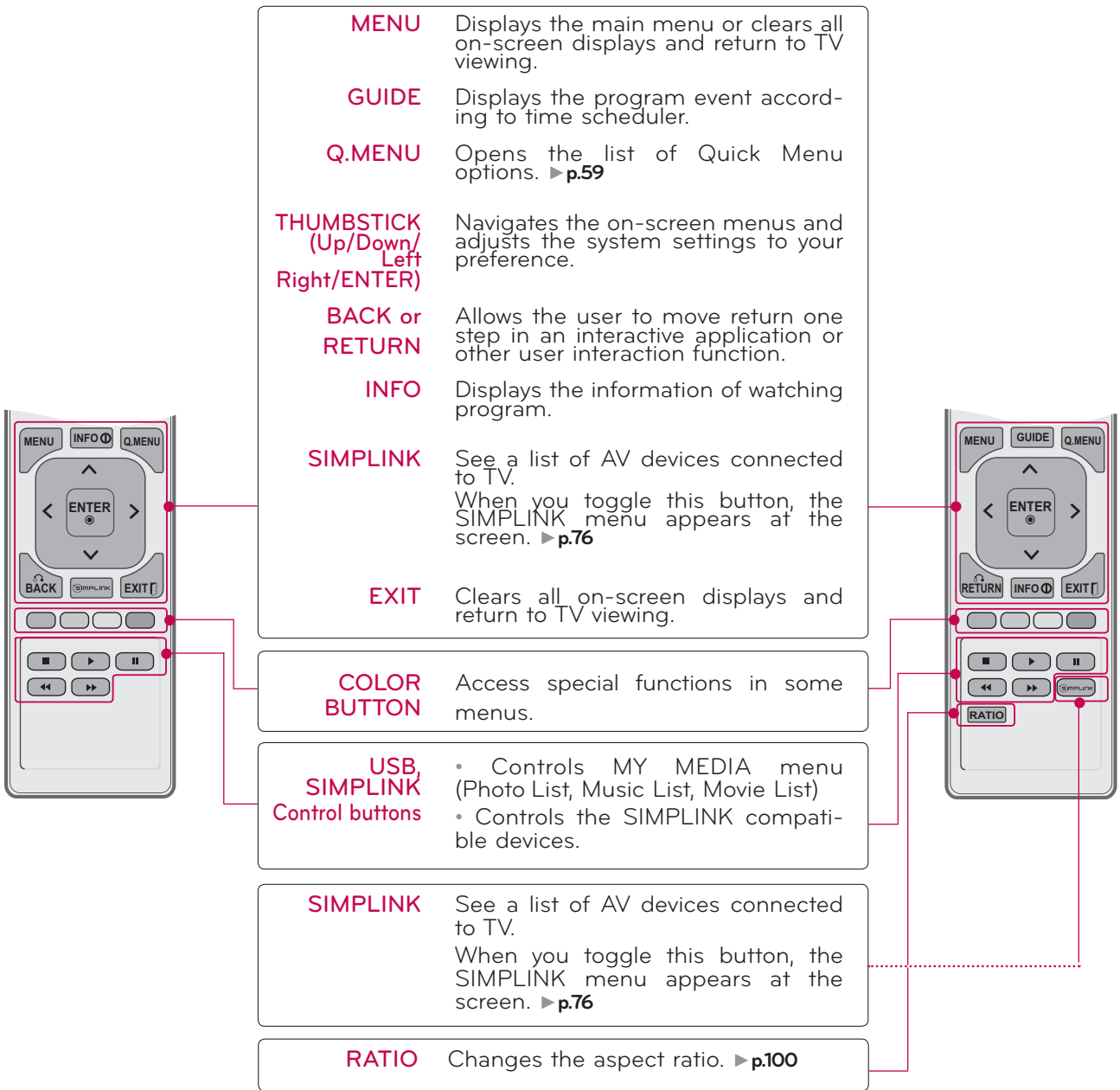

### Installing Batteries

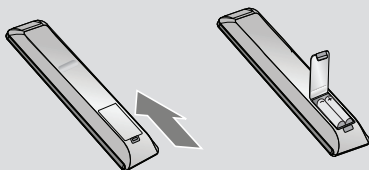

- Open the battery compartment cover on the back side and install the batteries matching correct polarity.
- Install two 1.5V AAA batteries. Don't mix old or used batteries with new ones.
- Close cover.

# WATCHING TV / CHANNEL CONTROL

## TURNING ON THE TV

- 1 First, connect power cord correctly.  
At this moment, the TV switches to standby mode.
  - In standby mode to turn TV on, press the **⏻ / I**, **INPUT, CH (▲ or ▼)** button on the TV or press the **⏻**, **INPUT, CH (▲ or ▼)**, **Number (0-9)** button on the remote control.
- 2 Select the viewing source by using the **INPUT** button on the remote control.
- 3 When finished using the TV, press the **POWER** button on the remote control. The TV reverts to standby mode.

### NOTE

- ▶ If you intend to be away on vacation, disconnect the power plug from the wall power outlet.
- ▶ If you do not complete the **Initial setting**, it will appear whenever the TV is switched on until the **Initial setting** procedure is completed.

## CHANNEL SELECTION

- 1 Press the **CH (▲ or ▼)** or **NUMBER** buttons to select a channel number.

## VOLUME ADJUSTMENT

Adjust the volume to suit your personal preference.

- 1 Press the **VOL (+ or -)** button to adjust the volume.
- 2 If you want to switch the sound off, press the **MUTE** button.
- 3 You can cancel the Mute function by pressing the **MUTE** or **VOL (+ or -)** button.

# INITIAL SETTING

This Function guides the user to easily set the essential items for viewing the TV for the first time when purchasing the TV. It will be displayed on the screen when turning the TV on for the first time. It can also be activated from the user menus.

- Default selection is **"Home Use"**. We recommend setting the TV to **"Home Use"** mode for the best picture in your home environment.
- **"Store Demo"** Mode is only intended for use in retail environments. Customers can adjust the **"Picture menu - Picture mode"** manually while inspecting the TV, but the TV will automatically return to preset in-store mode after 5 minutes.
- **"Store Demo"** Mode is an optimal setting for displaying at stores. **"Store Demo"** mode initializes the TV to set the image quality:

## Step 1. Selecting Language

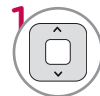
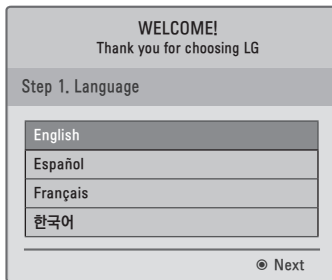

Select Menu Language.



## Step 2. Mode setting

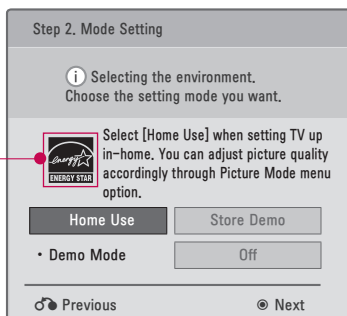

Select **Home Use**.





For 19/22/26/32/37/42/47/55LE5300,  
22/26LE5500, 42/47/55LE7300,  
37/42/47LD450C, 55LD520C,  
32/42/47/55LD520, 42/47/55LD630,  
42/47/55LE530C, 32/37/42/47LD452C,  
32/42/47LD452B, 26LD352C

# WATCHING TV / CHANNEL CONTROL

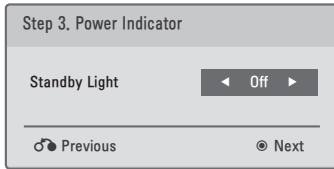
## Step 3. Power Indicator (For LED LCD TV)





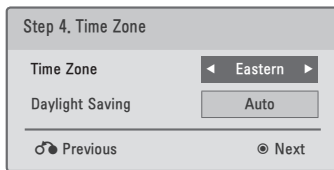

- 1  Select **On** or **Off**.
- 2 

■ This function is disabled in "Step2. Mode Setting - Store Demo".

## Step 4. Time Zone



- 1  Select **Time Zone** option.
- 2   Select **Daylight Saving** option.
- 3 

## Step 5. Auto Tuning

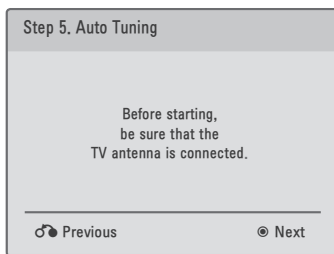

- 1  Check your antenna connection and start **Auto Tuning**.

# ON-SCREEN MENUS SELECTION

Your TV's OSD (On Screen Display) may differ slightly from that shown in this manual.

**1**   Display each menu.

**2**   Select a menu item.

**3**  Accept the current selection.

**4**  Return to TV viewing.

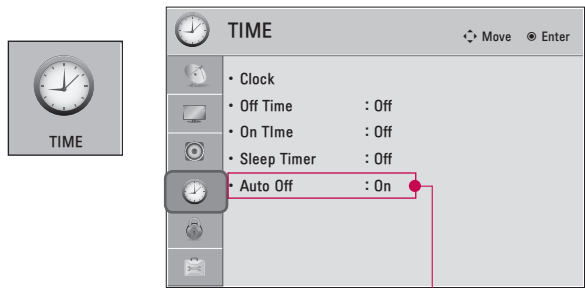
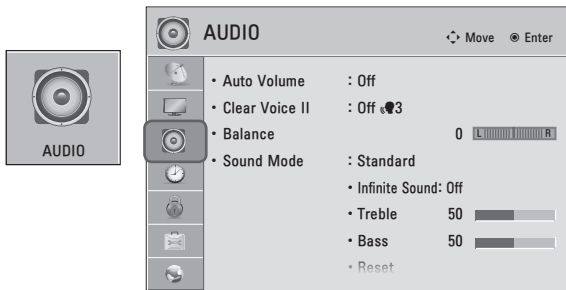
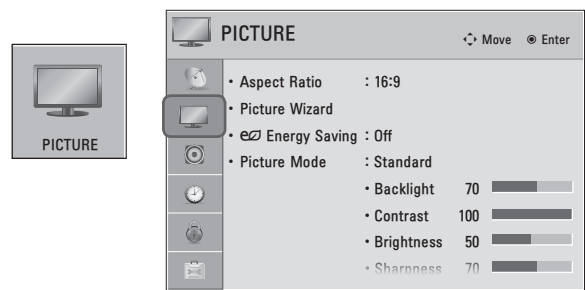

For 37/42/47LD450C, 55LD520C,  
42/4755LE530C,  
32/37/42/47LD452C,  
32/42/47LD452B, 26LD352C

## For USA

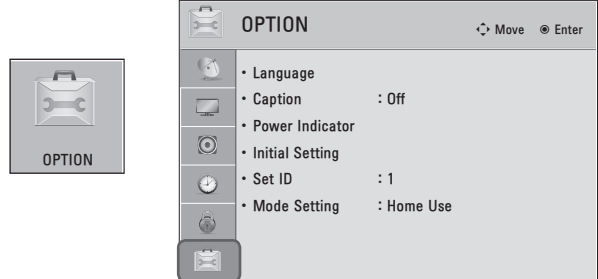
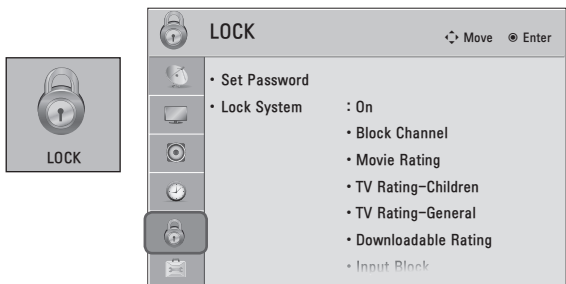

## For Canada

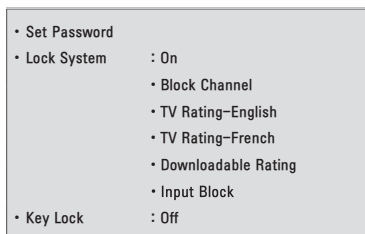

# WATCHING TV / CHANNEL CONTROL

i.e)

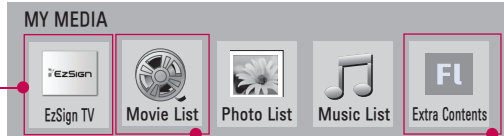
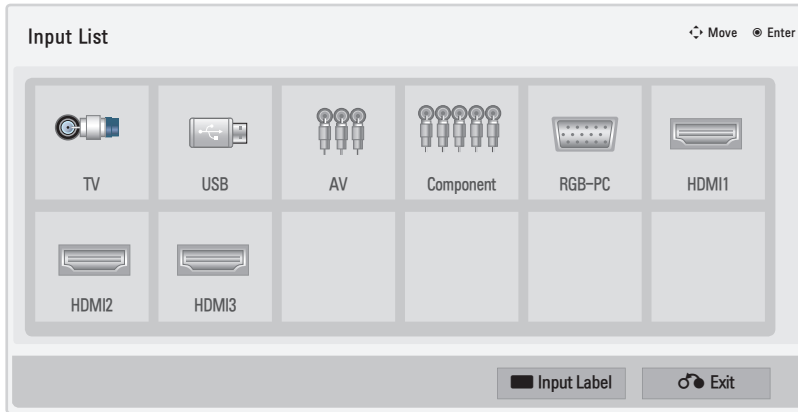
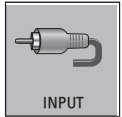

For 32/42/47LD452B

Except 32/42/47LD420,  
32/37/42/47LD450,  
37/42/47LD450C,  
32/42/47/55LD520,  
55LD520C,  
42/47/55LE530C,  
42/47LD451C,  
32/37/42/47LD452C,  
32/42/47LD452B,  
26LD352C







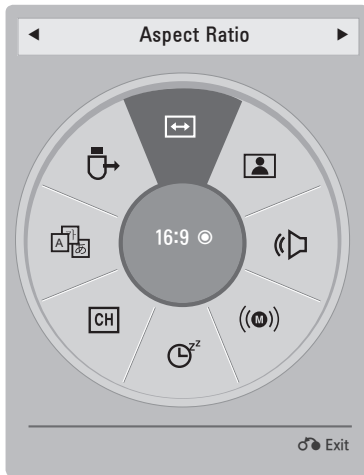

For 32/37/42/47LD452C

## QUICK MENU



Your TV's OSD (On Screen Display) may differ slightly from what is shown in this manual.

Q.Menu (Quick Menu) is a menu of features which users might use frequently.



-  **Aspect Ratio:** Selects your desired picture format.
-  **Picture Mode:** Selects the desired preset picture setting.
-  **Sound Mode:** Selects the desired preset sound setting.
-  **Multi Audio:** Changes the audio language (Digital signal).
-  **SAP:** Selects MTS sound (Analog signal).
-  **Sleep Timer:** Select the amount of time before your TV turns off automatically.
-  **CH Del/Add:** Select channel you want to add or delete.
-  **Caption:** Select on or off.
-  **USB Device:** Select "Eject" in order to eject a USB device.

**1**   Display each menu.

**2**   Make appropriate adjustments.

**3**  Return to TV viewing.







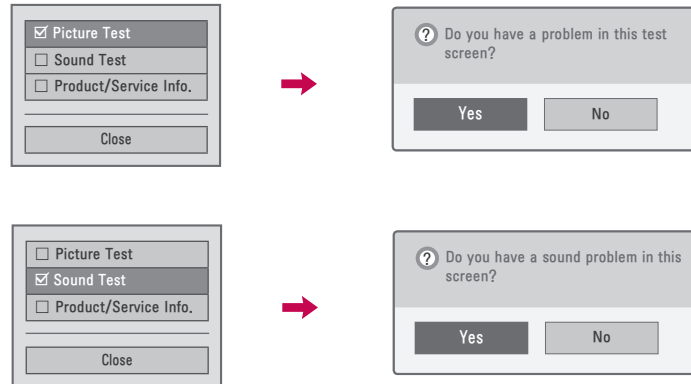

# WATCHING TV / CHANNEL CONTROL

## CUSTOMER SUPPORT

### Picture Test / Sound Test

This function is a customer support function that can execute picture and sound tests.







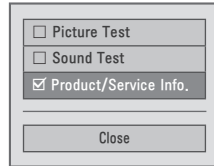

-   Select **Customer Support**.
-   Select **Picture Test** or **Sound Test**.
-   Select **Yes**.
-  or  Return to the previous menu.
-  Return to TV viewing.

## Product/Service Info.

This function shows support and product information.  
Customer Service Center can differ by country.







- 
-   Select **Customer Support**.
  -   Select **Product/Service Info.**  
You can check the various product/Service information based on your model.
  -  or  Return to the previous menu.
  -  Return to TV viewing.

# WATCHING TV / CHANNEL CONTROL

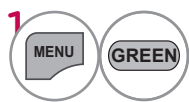
## SIMPLE MANUAL (Except 32/37/42/47LD452C, 32/42/47LD452B)

You can easily and effectively access the TV information by viewing a simple manual on the TV. During the Simple Manual operation, audio will be muted.

-  Select **Simple Manual**.
-  Select the part of the manual you would like to see.
-  Go to the **Index** page.
-  Play the **Simple Manual** automatically or manually.
-  Return to TV viewing.

# CHANNEL SETUP









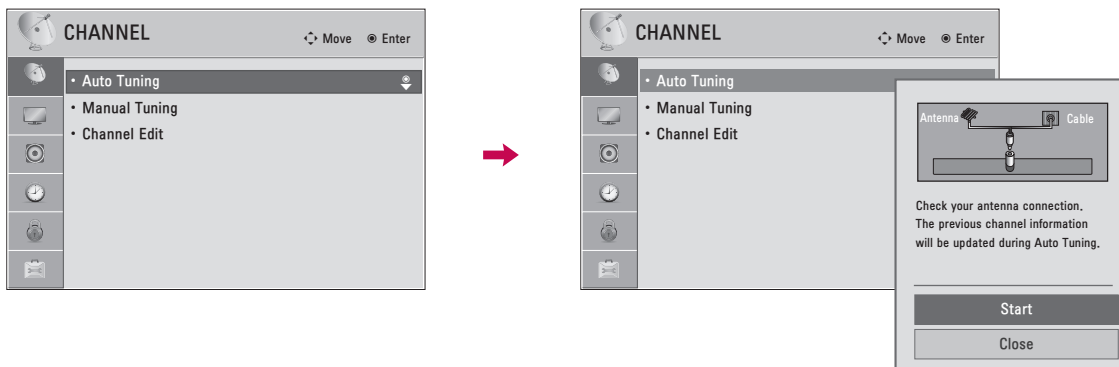

## Auto Scan (Auto Tuning)

Automatically finds all channels available through antenna or cable inputs, and stores them in memory on the channel list.

Run this function if you change your residence or move the TV.

Auto Tuning memorizes only the channels available at the time.



- 1   Select **CHANNEL**.
- 2   Select **Auto Tuning**.
- 3   Select **Start**.
- 4  Run **Auto tuning**.
- 5  or  Return to the previous menu.
-  Return to TV viewing.











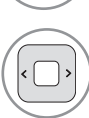

- The TV will ask for a password if parental control has been activated (LOCK Menu). Use the password you set up in the LOCK Menu to allow a channel search.
- The maximum number of channels the TV can store is 1000.
- Found channels are grouped in the order of DTV, TV, Cable DTV and Cable TV.

# WATCHING TV / CHANNEL CONTROL

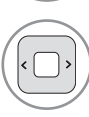
## Add/Delete Channel (Manual Tuning)

When selecting DTV or Cable DTV input signal in **Manual Tuning**, you can view the on-screen signal strength monitor to see the quality of the signal being received.



-   Select **CHANNEL**.
-   Select **Manual Tuning**.
-   Select **DTV, TV, Cable DTV,** or **Cable TV**.
-   Select channel you want to add or delete.
-   Select **Add** or **Delete**.
-  or  Return to the previous menu.
-  Return to TV viewing.

- The TV will ask for a password if parental control has been activated (LOCK Menu). Use the password you set up in the LOCK Menu to allow a channel search.
- The maximum number of channels the TV can store is 1000.

## Channel Editing

The channels in the Channel Edit List are displayed in black and the channels deleted from the Channel Edit List are displayed in blue.

When a channel number is deleted, it means that you will be unable to select it using CH $\wedge$ V button during TV viewing. If you wish to select the deleted channel, directly enter the channel number with the NUMBER buttons or select it in the Channel Edit menu.

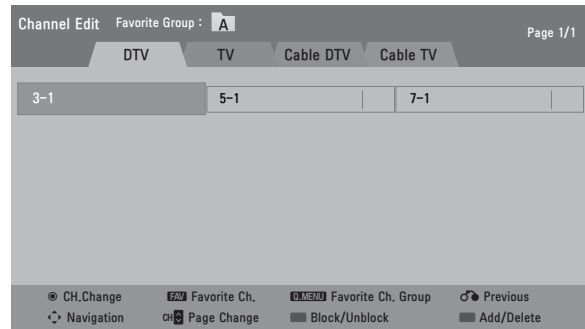
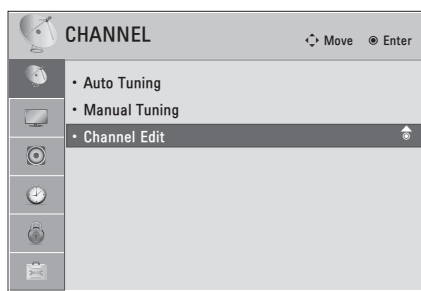

Block or unblock the channel.

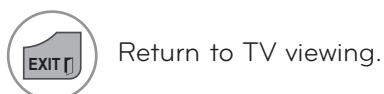
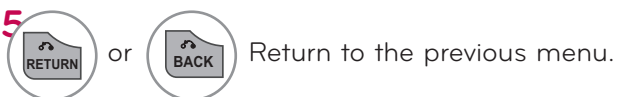
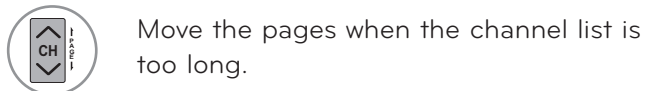
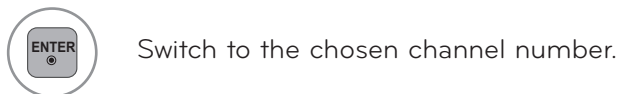
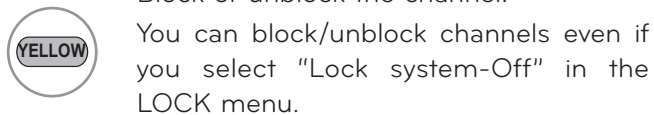





- Keep pressing the  $\wedge$  button and use the  $\leftarrow$  or  $\rightarrow$  buttons to move between DTV, TV, Cable DTV and Cable TV.

# WATCHING TV / CHANNEL CONTROL

## FAVORITE CHANNEL SETUP

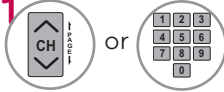
Favorite Channels are a convenient feature that lets you quickly select channels of your choice without waiting for the TV to select all the in-between channels.



-  Select your desired channel.
-  Select your desired favorite channel group from A to D.
-  Register or cancel the current channel in favorite channel list.
-  Go to the "CHANNEL menu - Channel Edit".
-  Return to TV viewing.

■ You can also setup **Favorite List** in the **CHANNEL** menu - **Channel Edit**.



## FAVORITE CHANNEL LIST





### Displaying the favorite channel list

-  Display the Favorite channel list.

### Selecting a channel in the favorite channel list

-  Select a channel.
-  Switch to the chosen channel number.

### Paging through a favorite channel list

-  Turn the pages.
-  Return to TV viewing.

# CHANNEL LIST

You can check which channels are stored in the memory by displaying the channel list.



This padlock is displayed when the channel is locked with parental control.

## Displaying Channel List



Display the **Channel List**.



Tune to the "CHANNEL menu - **Channel Edit**".

## Selecting a channel in the channel list



Select a channel.



Switch to the chosen channel number.

## Paging through a channel list



Turn the pages.





Return to TV viewing.

# WATCHING TV / CHANNEL CONTROL

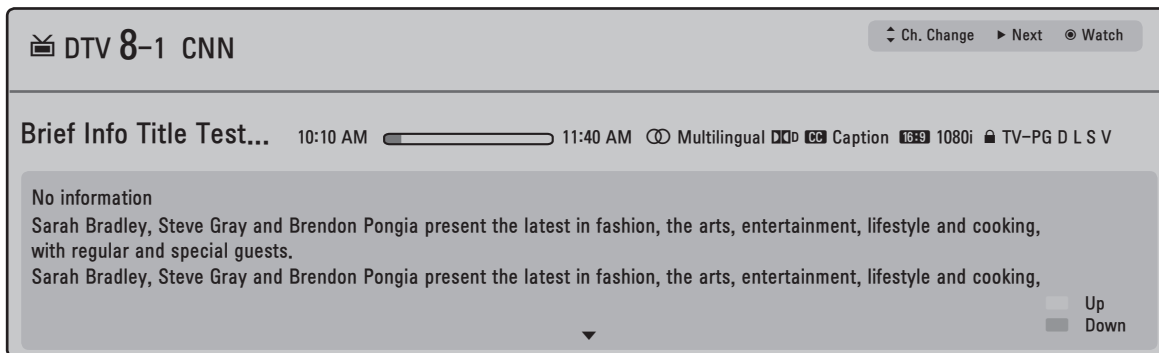
## CHANNEL INFORMATION





### Displaying Channel Information

-  Show the current channel program Information on the screen.
-  Show a previous or next channel's program information
-  Return to TV viewing.





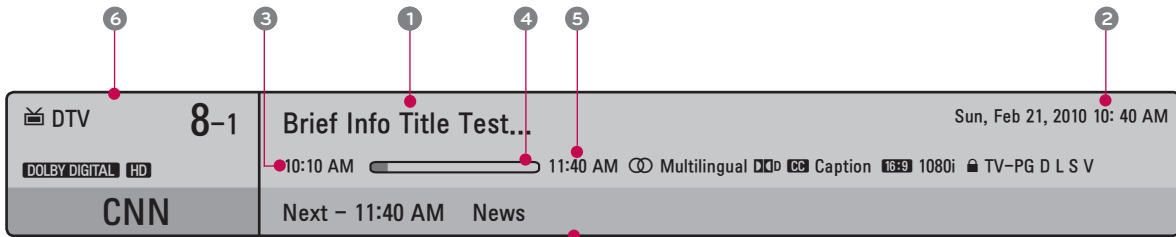

# CHANNEL BRIEF INFORMATION

Brief Info shows the present screen information.

**1**  Shows the current channel's brief info screen.

**2**  Return to TV viewing.



	<b>Multilingual</b> : The program contains two or more audio services. Use the <b>Q.MENU</b> menu to select wanted Audio.
	<b>Caption</b> : The program contains one or more caption services. Use the <b>Q.MENU</b> menu to select wanted Closed caption.
	<b>Dolby Digital</b> : The program contains a Dolby Digital audio signal in TV and HDMI input source.
	The original aspect ratio of the video is 4:3
	The original aspect ratio of the video is 16:9 (wide)
480i	The video resolution is 720x480i
480p	The video resolution is 720x480p
720p	The video resolution is 1280x720p
1080i	The video resolution is 1920x1080i
1080p	The video resolution is 1920x1080p
	<b>V-Chip</b> : The program contains V-Chip information. Refer to the LOCK menu: A (Age), D (Dialogue), L (Language), S (Sex), V (Violence), FV (Fantasy Violence)

- 1** Program title
- 2** Day, Month, Year, Present time
- 3** Program start time
- 4** Program progress bar
- 5** Program finish time
- 6** Banner information

# WATCHING TV / CHANNEL CONTROL

## INPUT LIST

Only these input signals which are connected to a TV can be activated and selected.

i.e)

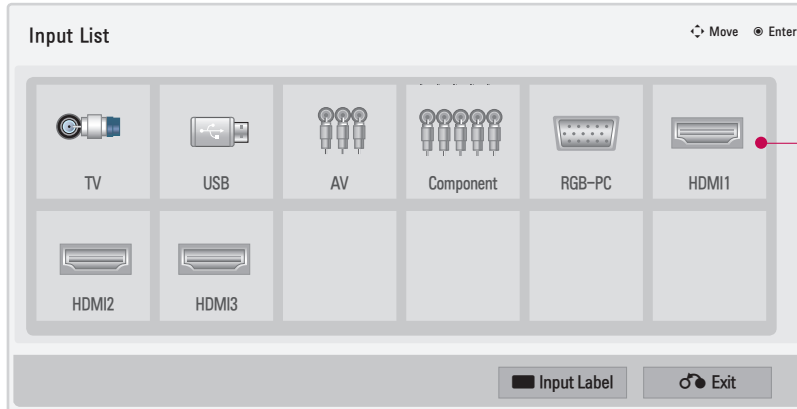

Disconnected inputs are inactive (grayed out)

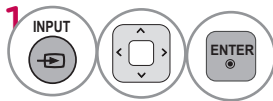

Select the desired input source.

- When new external device is connected, this popup menu is displayed automatically. If selecting **Yes**, you can select input source that you want to appreciate.
- But, when selecting "**SIMPLINK - On**", popup menu for HDMI input will not be displayed.

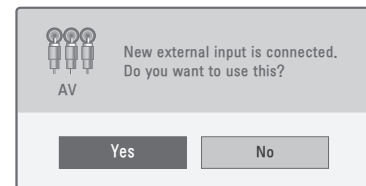





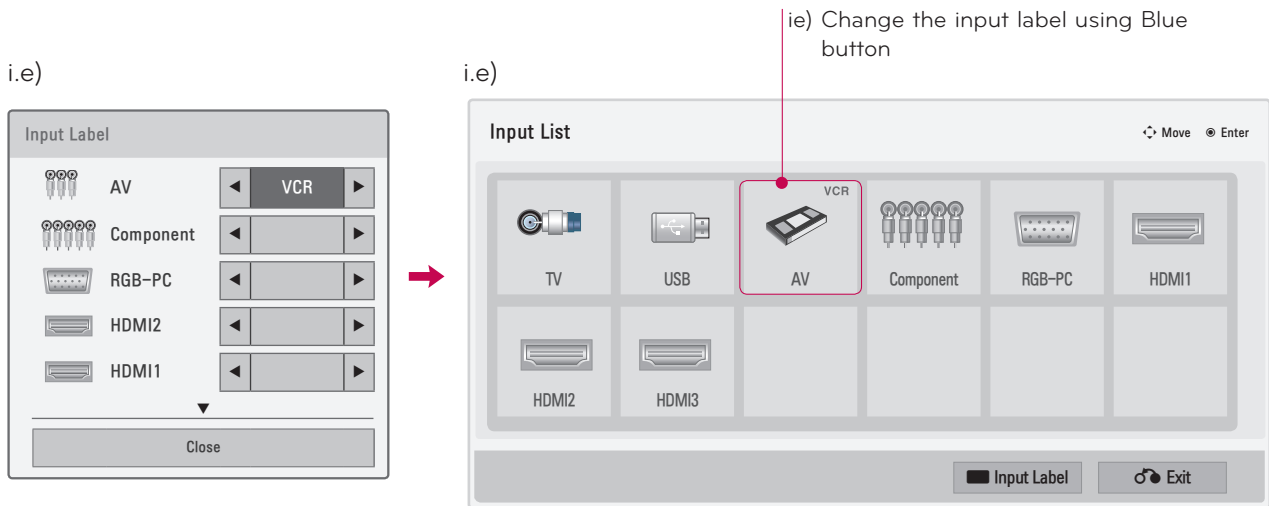

- **TV**: Select it to watch over-the-air, cable and digital cable broadcasts.
- **AV**: Select them to watch a VCR or other external equipment.
- **Component**: Select them to watch DVD or a Digital set-top box.
- **RGB-PC**: Select it to view PC input.
- **HDMI**: Select them to watch high definition devices.

# INPUT LABEL

This indicates which device is connected to which input port.









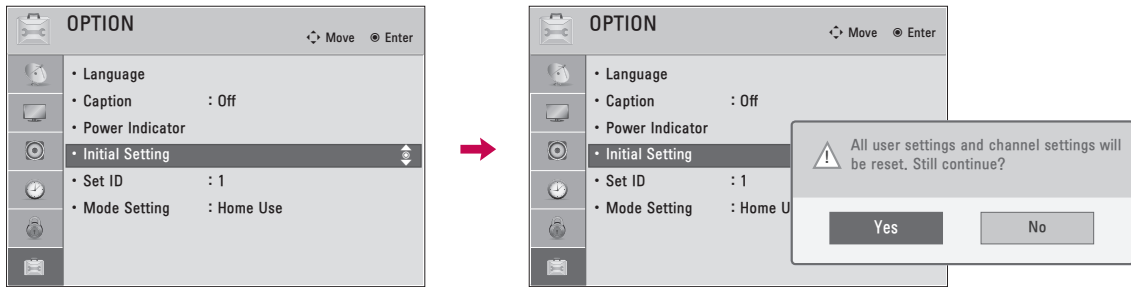

- 1   Select the desired input source.
- 2   Select the label.
- 3  or  Return to the previous menu.
-  Return to TV viewing.

# WATCHING TV / CHANNEL CONTROL

## RESET TO FACTORY DEFAULT (INITIAL SETTING)

This function resets the TV to factory default and erases all stored channels.



- 1   Select **OPTION**.
- 2   Select **Initial Setting**.
- 3   Select **Yes**.
- 4  TV turns off automatically and starts factory reset.







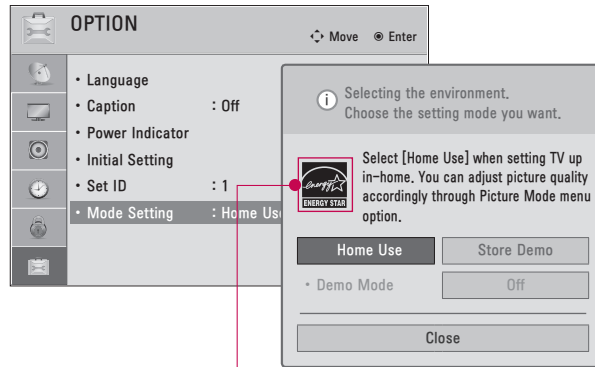
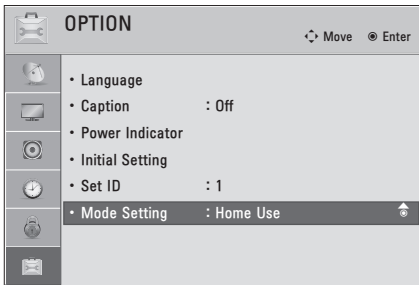

- When selecting "**Lock System - On**" in the LOCK menu, the message to enter the password appears.
- If you forget your password, press "0-3-2-5" on the remote control.

# MODE SETTING

Default selection is "Home Use". We recommend setting the TV to "Home Use" mode for the best picture in your home environment.



For 19/22/26/32/37/42/47/55LE5300, 22/26LE5500, 42/47/55LE7300, 37/42/47LD450C, 55LD520C, 32/42/47/55LD520, 42/47/55LD630, 42/47/55LE530C, 32/37/42/47LD452C, 32/42/47LD452B, 26LD352C

- 1   Select **OPTION**.
- 2   Select **Mode Setting**.
- 3   Select **Home Use**.
- 4  or  Return to the previous menu.
-  Return to TV viewing.









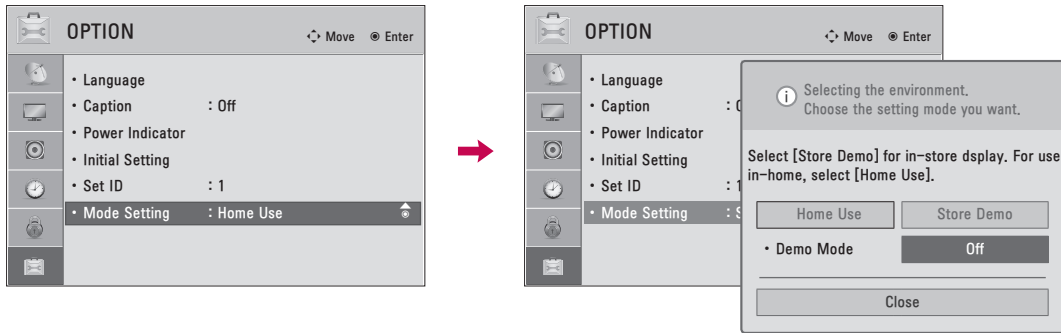

- "Store Demo" Mode is only intended for use in retail environments. Customers can adjust the "Picture menu - Picture mode" manually while inspecting the TV, but the TV will automatically return to preset in-store mode after 5 minutes.
- "Store Demo" Mode is an optimal setting for displaying at stores. "Store Demo" mode initializes the TV to set the image quality:

# WATCHING TV / CHANNEL CONTROL

## DEMO MODE

Displays a slide show to explain the various feature of this TV.



-   Select **OPTION**.
-   Select **Mode Setting**.
-   Select **Store Demo**.
-    Select **On**.
-  Return to TV viewing.  
After a while, **Demo Mode** starts.  
If you want to stop the demo, press any button (Except VOL +, - and MUTE button).

# AV MODE

AV Mode toggles through preset Video and Audio settings.

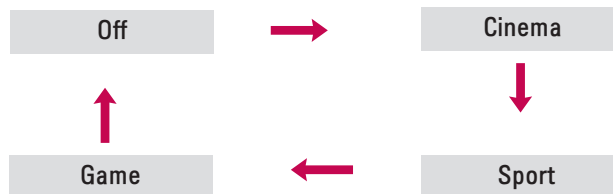

Press the **AV MODE** button repeatedly to select the desired source.



- If you select "**Cinema**" in AV mode, **Cinema** will be selected both for "PICTURE menu - Picture Mode" and "AUDIO menu - Sound Mode" respectively.
- If you select "**Off**" in AV mode, the "**Picture Mode**" and "**Sound Mode**" return to previous selected value.
- **Off**: Disables the AV MODE.
- **Cinema**: Optimizes video and audio for watching movies.
- **Sport**: Optimizes video and audio for watching sports events.
- **Game**: Optimizes video and audio for playing games.

When playing a video game using PlayStation or Xbox, it is recommended to use the **Game** mode.

When in **Game** mode, functions related to picture quality will be optimized for playing games.

# WATCHING TV / CHANNEL CONTROL

## SIMPLINK

SIMPLINK allows you to control and play other AV devices connected with HDMI cable without additional cables and settings. This TV may work with devices with HDMI-CEC support, but only devices with the SIMPLINK logo are fully supported.

SIMPLINK can be turned on and off in the user menus.



- 1 Display **SIMPLINK** menu.
- 2 Select **On**.
- 3 Select the desired device.
- 4 Control connected AV devices.

WATCHING TV / CHANNEL CONTROL

- 1 **TV viewing:** Switch to the previous TV channel regardless of the current mode.
- 2 **DISC playback:** Select and play discs. When multiple discs are available, the disc devices are conveniently displayed at the bottom of the screen.
- 3 **VCR playback:** Control the connected VCR.
- 4 **HDD Recordings playback:** Control recordings stored in HDD.
- 5 **Audio Out to Home Theater speaker/ Audio Out to TV:** Select Home Theater speaker or TV speaker for Audio Out.

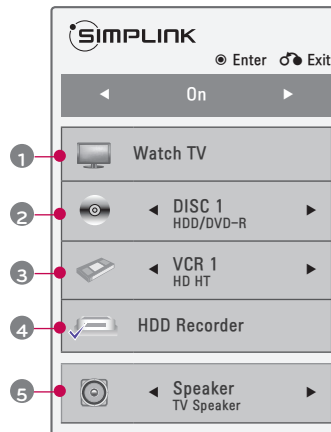

- ▶ When no device is connected (displayed in gray)
- ▶ Selected Device
- ▶ When a device is connected (displayed in bright color)

## SIMPLINK Functions

- **Direct Play:** After connecting AV devices to the TV, you can directly control the devices and play media without additional settings.
- **Select AV device:** Enables you to select one of the AV devices connected to the TV.
- **Disc playback:** Control connected AV devices by pressing the **^ v < >**, **ENTER**, **▶**, **■**, **||**, **◀** and **▶▶** buttons.
- **Power off all devices:** When you power off the TV, all connected devices are turned off.
- **Switch audio-out:** Offers an easy way to switch audio-out.
- **Sync Power on:** When the equipment with Simplink function connected HDMI terminal starts to play, The TV will automatically turn on.

Note: To operate SIMPLINK, an HDMI cable over Version 1.3 with \*CEC function should be used. (\*CEC: Consumer Electronics Control).

(A device, which is connected to the TV through a HDMI cable but does not support SIMPLINK, does not provide this function)

### NOTE

- ▶ Connect the HDMI/DVI IN or HDMI IN terminal of the TV to the rear terminal (HDMI terminal) of the SIMPLINK device with the HDMI cable
- ▶ When you switch the Input source with the INPUT button on the remote control, the SIMPLINK device will stop.
- ▶ When you select a device with home theater functionality, the sound output automatically switches to the home theater speakers and the TV speakers are turned off.
- ▶ If a connected SIMPLINK home theater system doesn't play the audio from the TV, connect the DIGITAL AUDIO OUT terminal on the back of the TV to the DIGITAL AUDIO IN terminal on the back of the SIMPLINK device with an OPTICAL cable.

# MY MEDIA

## CONNECTION METHOD

### USB Connection

- 1 Connect the USB device to the **USB IN** jack on the side of TV.

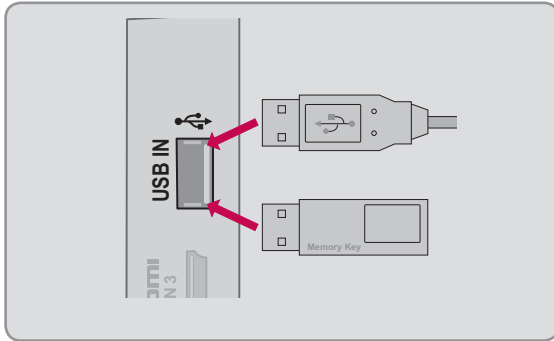

#### Precautions when using the USB device





- ▶ Only a USB storage device is recognizable.
- ▶ Connecting a USB storage device through a USB hub is not supported.
- ▶ A USB storage device which uses its own driver may not be recognized.
- ▶ The recognition speed of a USB storage device may depend on each device.
- ▶ Please do not turn off the TV or unplug the USB device when the connected USB storage device is working. When such device is suddenly separated or unplugged, the stored files or the USB storage device may be damaged.
- ▶ Only use a USB storage device which has normal music files, image files, or movie files.
- ▶ Please use only a USB storage device which was formatted as a FAT 32 or NTFS file system provided with the Windows operating system. Others may not be recognized.
- ▶ Some USB storage devices require a power adapter. The power adapter must be connected in order to be seen by the TV.
- ▶ If a device is not recognized by the TV, try a different cable. Excessively long cables are not supported.
- ▶ Some USB storage devices may not be supported or operate properly.
- ▶ Please backup important files because data on USB device could be damaged. Data management is consumer's responsibility and as a result, the manufacturer does not cover data damage.
- ▶ If your USB memory device has multiple partitions, or if you use a USB multi-card reader, you can use up to 4 partitions or USB memory devices.
- ▶ In case of USB storage devices formatted as NTFS, deletion is not supported.
- ▶ File alignment method of USB storage device is similar to Window XP and file names can be up to 100 English characters.
- ▶ The recommended capacity is 1TB or less for a USB external hard disk and 32 GB or less for USB memory.
- ▶ If a USB external hard disk with a "Energy Saving" function doesn't work, turn the hard disk off and on again to make it work properly. Refer to the user manual of the USB external hard disk.
- ▶ USB storage devices below USB 2.0 are supported as well. But they may not work properly in the movie list.

# ENTRY MODE

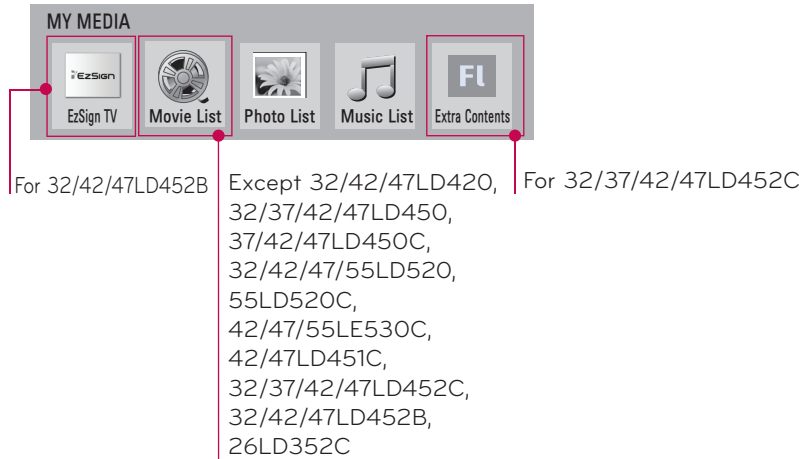
The My Media menu will open automatically when you insert a USB drive. My Media can also be accessed by choosing My Media in the user menu.

On USB device, you can not add a new folder or delete the existing folder.



- 1   Select **MY MEDIA**.
- 2   Select **EzSign TV, Movie List, Photo List or Music List or Extra Contents**.
- 3 

■ This TV can view JPG image files, HD DivX files or play MP3 audio files.

**When removing the USB device**

Select the **USB Device** menu before removing the USB device.

- 1   Select **USB Device**.
- 2  Select **Eject**.

## MOVIE LIST

(Except 32/42/47LD420, 32/37/42/47LD450, 37/42/47LD450C, 32/42/47/55LD520, 55LD520C, 42/47/55LE530C, 42/47LD451C, 32/37/42/47LD452C, 32/42/47LD452B, 26LD352C)

The movie list is activated once a USB drive is detected. It is used when playing movie files on the TV. It displays all of the video files it recognizes.

The On-Screen Display on your model may be slightly different.

### Supported movie file

- Resolution: under 1920 pixel (width) x 1080 pixel (height)
- Frame Rate: under 30 frame/sec (1920x1080), under 60 frame/sec (1280x720)
- Max bitrate of playable video file: 20 Mbps (Mega bit per second)
- Bit rate : within 32 kbps to 320 kbps (MP3)
- Supported external subtitle format: \*.smi/\*.srt/\*.sub (MicroDVD,Subviewer1.0/2.0)/\*.ass/\*.ssa/\*.txt (TMPlayer)/\*.psb (PowerDivX)
- Supported Internal subtitle format: only, XSUB (It is the subtitle format used in DivX6 files)

### Precautions when playing the video files

- ▶ Some user-created subtitles may not work properly.
- ▶ Some special characters are not supported in subtitles.
- ▶ HTML tags are not supported in subtitles.
- ▶ Time information in an external subtitle file should be arranged in ascending order to be played.
- ▶ The screen may suffer temporary interruptions (image stoppage, faster playback, etc.) when the audio language is changed.
- ▶ A damaged video file may not be played correctly, or some functions may not be usable.
- ▶ Video files produced with some encoders may not be played correctly.
- ▶ If the video and audio structure of recorded file is not interleaved, the file not playback properly.
- ▶ Video with resolution higher than maximum resolution supported for each frame, cannot be guaranteed for smooth playback.
- ▶ Video files other than the specified types and formats may not work properly.
- ▶ The movie file encoded by the GMC (Global Motion Compensation) is not supported.
- ▶ Only 250 Korean characters, 500 letters and 500 numbers are supported for each line of the subtitle.
- ▶ Only 10000 sync blocks are supported within the subtitle file.
- ▶ We do not guarantee smooth playback of profiles encoded level 4.1 or higher in H.264/AVC.
- ▶ DTS Audio codec is not supported.
- ▶ A video file more than 30GB in file size is not supported for playback.
- ▶ Playing a video via a USB connection that doesn't support high speed may not work properly.
- ▶ USB storage devices below USB 2.0 are supported as well. But they may not work properly in the movie list.
- ▶ The video file and its subtitle file must be located in the same folder.  
At this time, a video file name and its subtitle file name must be identical for it to be displayed.
- ▶ When you are watching a movie via the Movie List function, you can adjust the picture with the ENERGY SAVING and AV MODE button on the remote control. User setup for each picture mode is not supported.

## Supported Video Formats

File Extension name	Video Decoder	Audio Codec	Max Resolution
mpg, mpeg	MPEG1, MPEG2	MP2, MP3, Dolby Digital, LPCM	1920 x 1080 @ 30p (Only Motion JPEG 640x480@30p)
dat	MPEG1	MP2	
ts, trp, tp	MPEG2, H.264, AVS, VC1	MP2, MP3, Dolby Digital	
vob	MPEG1, 2	MP2, MP3, Dolby Digital, LPCM	
mp4, mov	MPEG4, DivX 3.11, DivX 4.12, DivX 5.x, DivX 6, Xvid 1.00, Xvid 1.01, Xvid 1.02, Xvid 1.03, Xvid 1.10-beta1/2H.264	MP3	
mkv	H.264, MPEG-1,2,4	MP2, MP3, Dolby Digital, LPCM	
divx, avi	MPEG2, MPEG4, DivX 3.11, DivX 4, DivX 5, DivX 6, Xvid 1.00, Xvid 1.01, Xvid 1.02, Xvid 1.03, Xvid 1.10-beta1/2H.264	MP2, MP3, Dolby Digital, LPCM, ADPCM	
Motion JPEG (avi, mp4, mkv)	JPEG	LPCM, ADPCM	
asf, wmv	VC1	WMA	
flv	Sorenson H.263, H264	MP3	

# MY MEDIA

## Screen Components





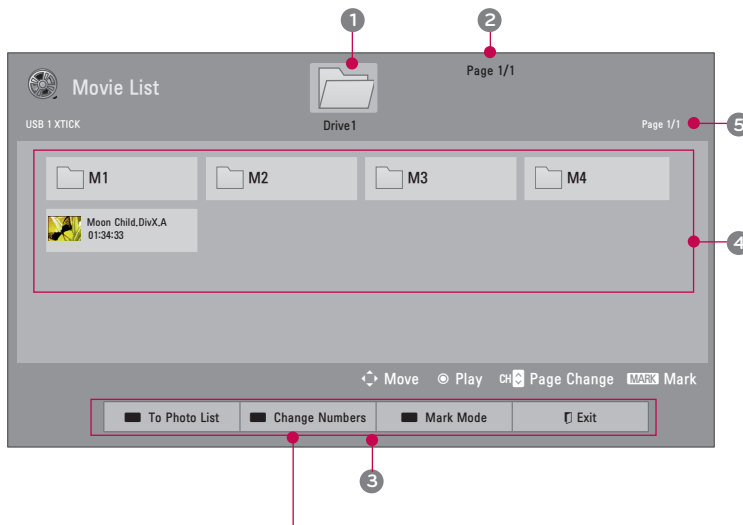

- 1 Moves to upper level folder
- 2 Current page/Total pages
- 3 Corresponding buttons on the remote control
- 4 Contents under the folder focused on 1
- 5 Current page/total pages of contents

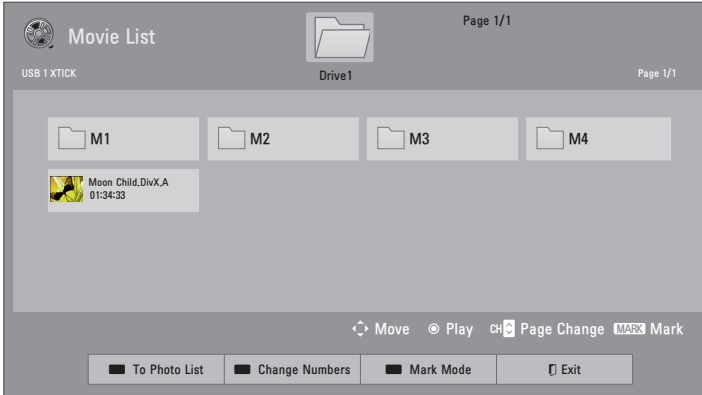

	Move to <b>Photo List</b> or <b>Music List</b> .
	<b>Change Numbers:</b> Changes the number or thumbnails displayed at a time.
	Allows you to mark certain files.
	Return to TV viewing.

## Movie Selection





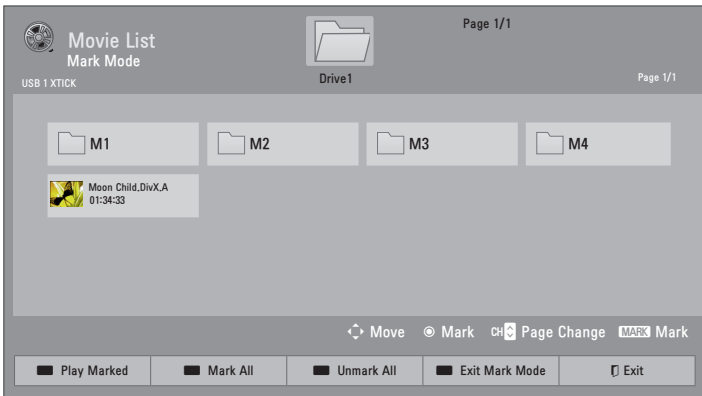

- 1  Select the target folder or drive.
- 2   Select the desired movie title.
- 3  Play the movie file.

■ Use the CH (^ v) button to navigate in the movie page.

## Mark Mode



- 1  Select the target folder or drive.
- 2   Select the desired movie title.
- 3  Mark your desired movie file.
- 4  Play the marked movie file. It displays the current movie status progress bar on the bottom of the screen.

**RED**

**Play Marked:** Play the first selected file. Once a movie finishes playing, the next selected one will be played automatically.

**GREEN**

**Mark All:** Mark all files in the folder.

**YELLOW**

**Unmark All:** Deselect all marked files.

**BLUE**



Exit the Mark Mode.

■ When one or more movie files are marked, the marked movies will be played in sequence.

# MY MEDIA

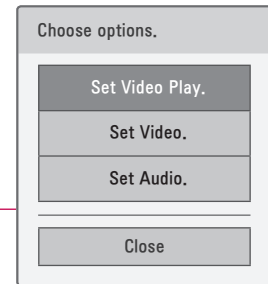
## Using the Movie List Function











- 1  Show the **Option** menu.
- 2   Select **Set Video Play.**, **Set Video.**, or **Set Audio.**

### NOTE

- ▶ Option values changed in the Movie List does not affect Photo List and Music List.
- ▶ Option values changed in Photo List and Music List are changed likewise in Photo List and Music List, but not in the Movie List.
- ▶ When replaying a video file after stopping, you can play from where it stopped automatically.
- ▶ If you select "Yes" when playing the same file after the video file has been stopped, it will restart where it stopped previously.
- ▶ If continuous series files exist within the folder, the next file will automatically be played. But, this excludes cases when the Repeat function of Movie List Option is turned "On" (Refer to page 85) or when set as **Marked Play**.

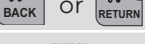
## Using the remote control

	Return to TV viewing.
	Select the required speed: x2, x4, x8, x16, x32 (backward/forward).
	Pauses the media player. If no buttons are pressed on the remote control for 10 minutes after pausing, the TV returns to the playback state.
	Displays a slow motion.
	Move to a specific frame forward or backward while playing a video. A cursor indicating the position can be viewed on the screen. It may not work properly for some movie files.
	Return to normal playback.
	Hide the menu on screen. To see the menu again, press <b>ENTER</b> button to display.
	Press the <b>ENERGY SAVING</b> button repeatedly to increase the brightness of your screen (Refer to p. 104).
	Press the <b>AV MODE</b> button repeatedly to select the desired source (Refer to p. 75).

## Set Video Play Menu Options

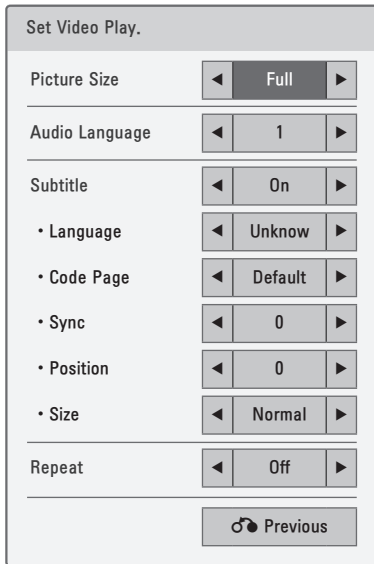

1 Select **Picture Size**, **Audio Language**, **Subtitle**, or **Repeat**.



2 Make appropriate adjustments.

### Code Page

Subtitle Language Group	Supported Language
Latin1	English, Spanish, French
Korean	English, Korean

- **Picture Size:** Selects your desired picture format for videos.
- **Audio Language:** Changes the Language Group of the audio for video files.
- **Subtitle Language:** The subtitles can be turned on or off. If there are two or more subtitles, you can select one of them.
- **Language:** Activated for SMI subtitles and can select the language within the subtitle.
- **Code Page:** Subtitle font selection. When set to default, same font as general menu will be used.
- **Sync:** When the video is not synchronized with the captions, it can be adjusted by 0.5 second.
- **Position:** Move the location of the subtitles.
- **Size:** Changes the subtitle font size.
- **Repeat:** Turn on/off repeat function of movie playback. When turned on, the file within the folder will be played back repeatedly.

# MY MEDIA

\* Image shown may differ from your TV.

## Set Video Menu Options

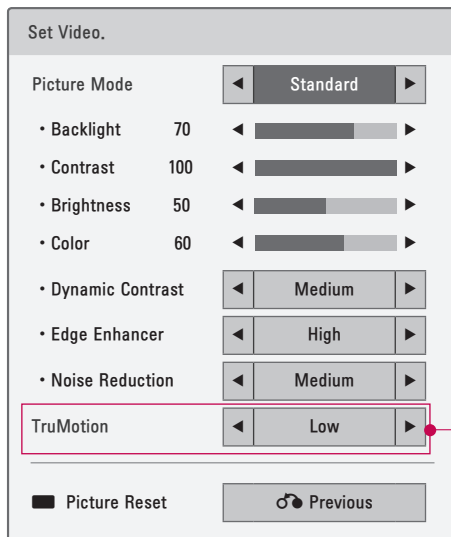

('TruMotion' dependent on model)

MY MEDIA

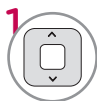

Select **Picture Mode** or **TruMotion**.



Make appropriate adjustments.



Reset picture settings to default.

## Set Audio Menu Options

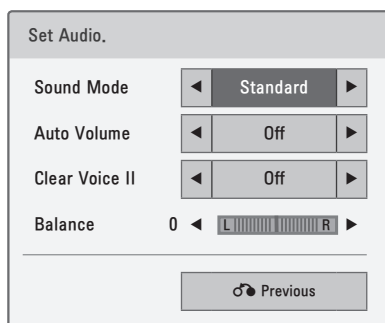

Select **Sound Mode**, **Auto Volume**, **Clear Voice II** or **Balance**.



Make appropriate adjustments.

# PHOTO LIST

The On-Screen Display on your model may be slightly different.

## Supported photo file: \*.JPG

- Baseline: 64 pixel (width) x 64 pixel (height) to 15360 pixel (width) x 8640 pixel (height)
- Progressive: 64 pixel (width) x 64 pixel (height) to 1920 pixel (width) x 1440 pixel (height)
- You can play JPEG files only.
- Non-supported files are displayed in the form of predefined icon.

## Screen Components



- 1 Moves to upper level folder
- 2 Current page/total pages
- 3 Corresponding buttons on the remote control
- 4 Contents under the folder focused on 1
- 5 Current page/total pages of contents

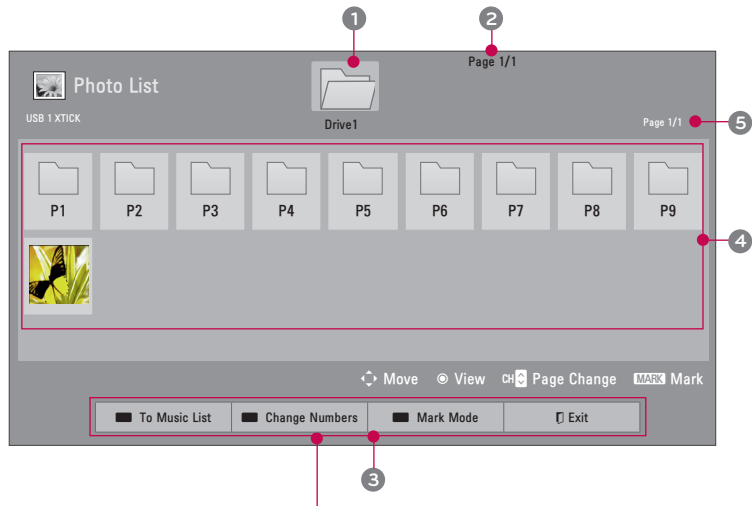



<b>GREEN</b>	Move to <b>Music List</b> or <b>Movie List</b> .
<b>YELLOW</b>	<b>Change Numbers:</b> Changes the number or thumbnails displayed at a time.
<b>BLUE</b>	Allows you to mark certain files.
<b>EXIT</b>	Return to TV viewing.

# MY MEDIA

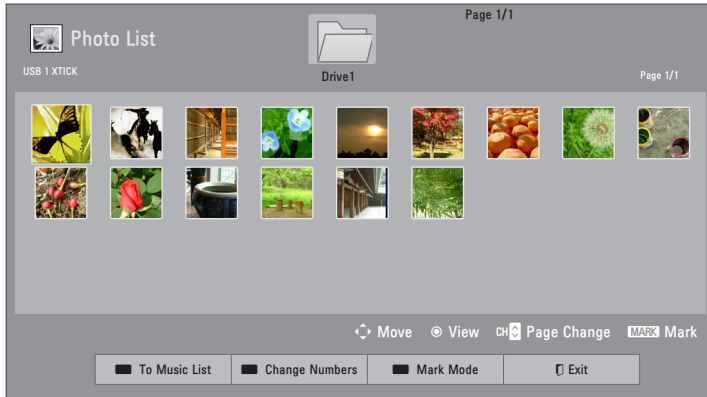
## Photo Selection









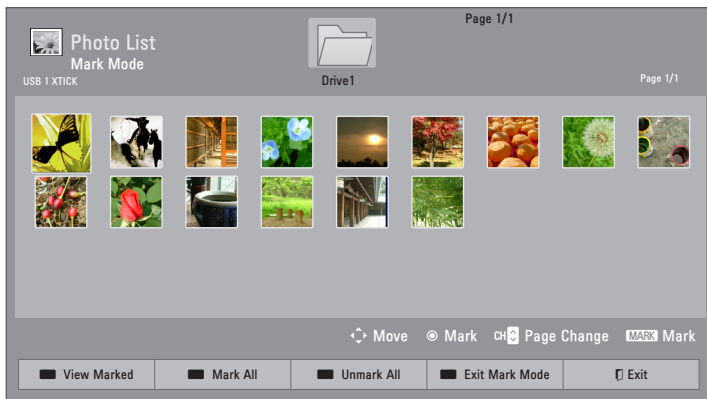

- 1  Select the target folder or drive.
- 2   Select the desired photos.
- 3  Photo file is displayed.

■ Use the CH (^ v) button to navigate in the photo page.

## Mark Mode



- 1  Select the target folder or drive.
- 2   Select the desired photo files.
- 3  Mark your desired photo files.
- 4  View the marked photo files.

- |   |   |
|---|---|
|  | <b>View Marked:</b> Display the selected photo. |
|  | <b>Mark All:</b> Mark all photos on the screen. |
|  | <b>Unmark All:</b> Deselect all marked photos.  |
|  | Exit the Mark Mode.                             |



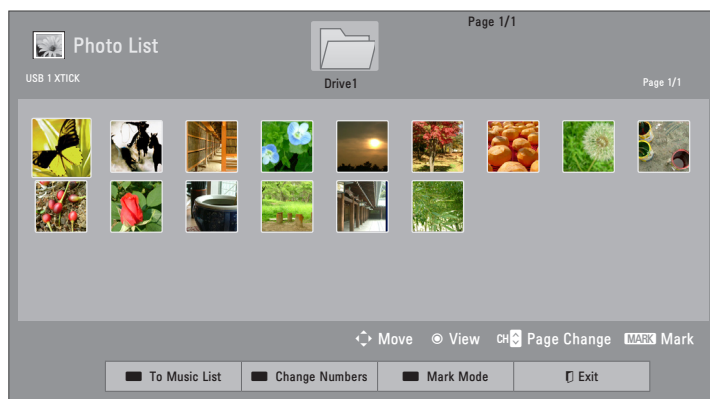

■ When one or more photos are marked, you can view individual photos or a slide show of the marked photos. If no photos are marked, you can view all photos individually or all photos in the folder in a slide show.

## Full Screen Menu

More operations are available in full screen mode.



The aspect ratio of a photo may change the size of the photo displayed on the screen in full size.

-  Select the target folder or drive.
-   Select the desired photos.
-  The selected photo is displayed in full size.

■ Use the CH (^ v) button to navigate in the photo page.

# MY MEDIA

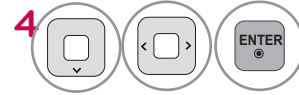
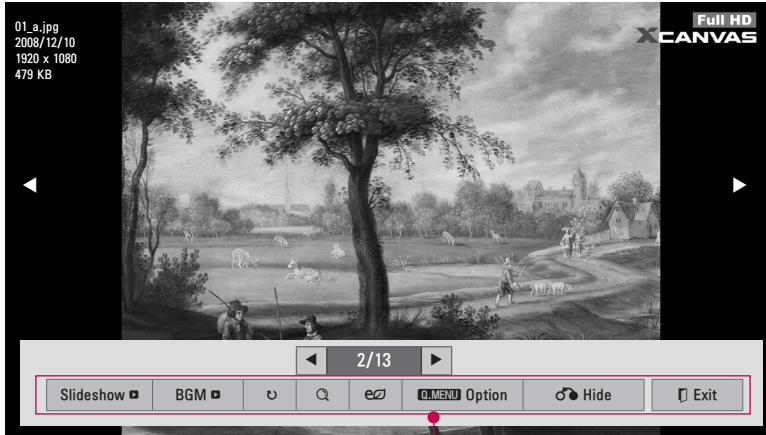



4 Select the **Slideshow**, **BGM**, **⤵ (Rotate)**, **🔍 (Zoom In)**, **⚡ (Energy Saving)**, **Option**, or **Hide**.

- Use **< >** button to select the previous or next photo.

- ▶ **Slideshow**: Selected photos are displayed during the slide show. If no photo is selected, all photos in the current folder are displayed during slide show.
  - Set the time interval of the slide show in **Option-Set Photo View** menu (Refer to p. 91).
  - You can adjust **Option** by using the **Q.MENU** button on the remote control.
- ▶ **BGM (Background Music)**: Listen to music while viewing photos in full size.
  - Set the BGM device and album in **Option-Set Photo View** menu (Refer to p. 91).
  - You can adjust **Option** by using the **Q.MENU** button on the remote control.
- ▶ **⤵ (Rotate)**: Rotate photos.
  - Rotates the photo 90 °, 180 °, 270 °, 360 ° clockwise.
  - Photos cannot be rotated if its width is greater than the available supported resolution height.
- ▶ **🔍 (Zoom In)**: View the photo by zoom in 2, 4 times by using Blue button.
- ▶ **⚡ (Energy Saving)**: Increase the brightness of your screen by using ENERGY SAVING button.
- ▶ **Option**: Set values for **Slide Speed** and **Music Album** (Refer to p. 91).
  - You cannot change **Music Album** while BGM is playing.
  - You can only select the MP3 folder saved on the device that currently displays the photo.
- ▶ **Hide**: Hide the menu on the full-sized screen.
  - To see the menu again on the full-sized screen, press **ENTER** button to display.
- ▶ **Exit**: Move to the previous menu screen.

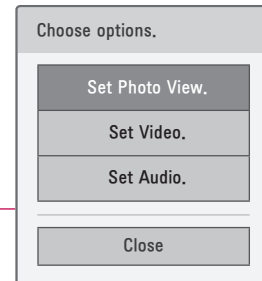
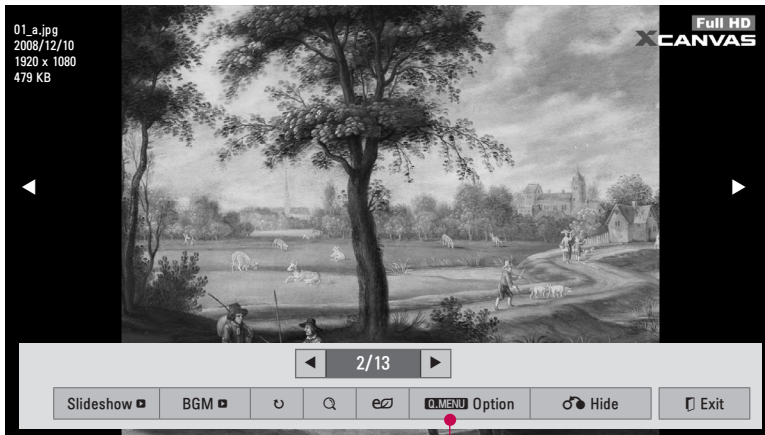
## Using the Photo List Function





- 1  Show the **Option** menu.
- 2  Select **Set Photo View.**, **Set Video.**, or **Set Audio.**

### NOTE

- ▶ Option values changed in Photo List do not affect Movie List and Music List.
- ▶ Option values changed in Photo List or Music List are changed likewise in Photo List and Music List, but not Movie List.

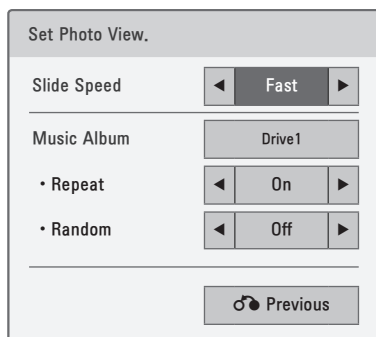
## Set Photo View Menu Options







- 1  Select **Slide Speed** or **Music Album**.
- 2  Make appropriate adjustments.

# MY MEDIA

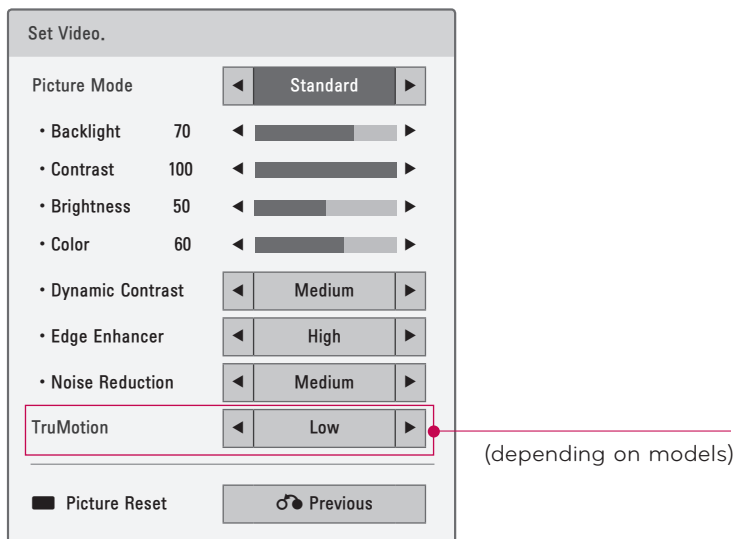
\* Image shown may differ from your TV.



## Set Video Menu Options

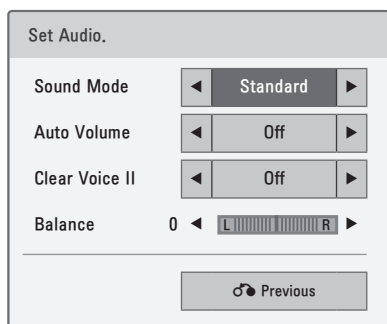

- 1  Select **Picture Mode** or **TruMotion**.
- 2  Make appropriate adjustments.
-  Initialize the adjusted picture value.

## Set Audio Menu Options



- 1  Select **Sound Mode**, **Auto Volume**, **Clear Voice II** or **Balance**.
- 2  Make appropriate adjustments.

# MUSIC LIST

This TV cannot play back copy-protected files.  
The On-Screen Display on your model may be slightly different.

- MUSIC (\*.MP3) supporting file
- Bit rate 32 Kbps - 320 Kbps
- Sampling rate MPEG1 Layer3: 32 kHz, 44.1 kHz, 48 kHz
  - Sampling rate MPEG2 Layer3: 16 kHz, 22.05 kHz, 24 kHz
  - Sampling rate MPEG2.5 Layer3: 8 kHz, 11.025 kHz, 12 kHz

## Screen Components

**1** Select **MY MEDIA**.

**2** Select **Music List**.

**1** Preview: If any album jacket for the file (Album Art Image) exists, this picture is displayed.

**2** Moves to upper level folder

**3** Current page/Total pages

**4** Corresponding buttons on the remote control

**5** Contents under the folder focused on **1**





**6** Current page/total pages of contents

<b>GREEN</b>	Move to <b>Movie List</b> or <b>Photo List</b> .
<b>YELLOW</b>	<b>Change Numbers:</b> Changes the number or thumbnails displayed at a time.
<b>BLUE</b>	Allows you to mark certain files.
	Return to TV viewing.
	Press the <b>ENERGY SAVING</b> button repeatedly to increase the brightness of your screen (Refer to p. 104). (It's available "ENERGY SAVING - Off, Screen Off" only.)

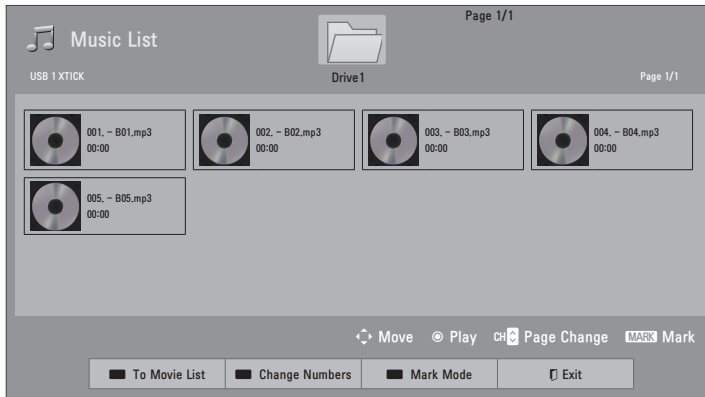
# MY MEDIA

## Music Selection









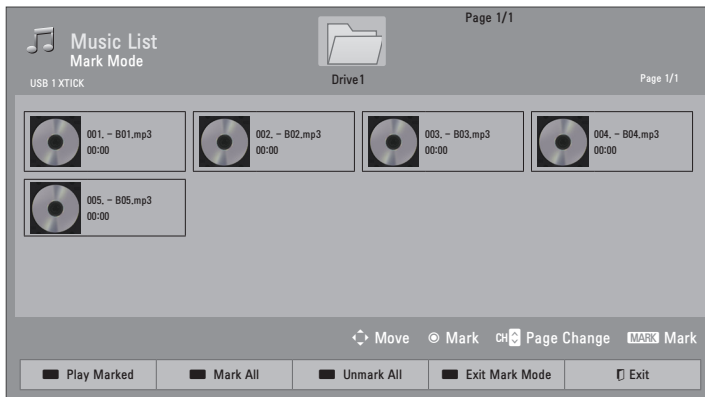

- 1  Select the target folder or drive.
- 2   Select the desired music file.
- 3  Music files are played.

- Use the CH (^ v) button to navigate in the music page.

## Mark Mode



- 1  Select the target folder or drive.
- 2   Select the desired music file.
- 3  Mark your desired music file.
- 4  Play the marked music file.

	<b>Play Marked:</b> Play the selected songs. Once a song finishes playing, the next selected one will be played automatically.
	<b>Mark All:</b> Mark all songs in the folder.
	<b>Unmark All:</b> Deselect all marked song.
	Exit the Mark Mode.

- When one or more music files are marked, the marked music files will be played in sequence.

## Using the Music List Function

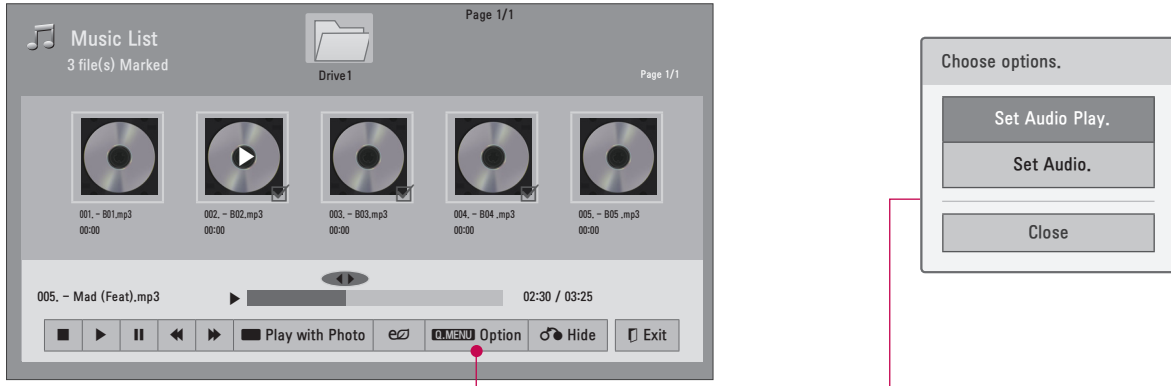

1 Show the **Option** menu.

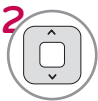

2 Select **Set Audio Play.** or **Set Audio..**

### NOTE

- ▶ Option values changed in Movie List does not affect Photo List and Music List.
- ▶ Option value changed in Photo List and Music List are changed likewise in Photo List and Music List excluding Movie List.
- ▶ You can listen to the music only within the device currently played.

## Using the remote control

	Stop playback.
	Return to normal playback.
	Paused playback.
	Select the previous or next song.
	<b>Play with Photo:</b> Start playing the selected songs and then move to the Photo List.
	Press the <b>ENERGY SAVING</b> button repeatedly to increase the brightness of your screen (Refer to p. 104). (It's available "ENERGY SAVING - Off, Screen Off" only.)
	A cursor indicating the position can be played on the screen.
	Move to the previous menu screen.

## Set Audio Play Menu Options

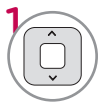

1 Select **Repeat** or **Random**.



2 Make appropriate adjustments.

## Set Audio Menu Options

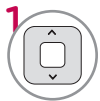
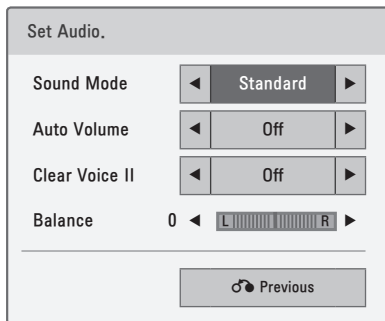

1 Select **Sound Mode**, **Auto Volume**, **Clear Voice II** or **Balance**.



2 Make appropriate adjustments.

- If you don't press any buttons for a while, the play information box will float across the screen. This prevents screen pixel damage due to a fixed image remaining on the screen for an extended period of time.

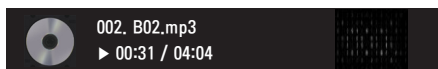

### NOTE

- ▶ Music files with copy-protection will not play.
- ▶ Press ENTER or  button to stop the screen saver.

## EXTRA CONTENTS

- For 32/37/42/47LD452C

You can play application files on USB device.

Application files your device can be played by this unit.

The On Screen Display may be different from your TV. Images are an example to assist with the TV operation.

FLASH (\*.SWF) / GEM supporting file

An SWF file complied with Flash Lite 3.0 or earlier (the 3.0 version is recommended)

- The Pro: Centric application is required, which starts automatically in the flash memory when the TV is turned on.
- The folder called /hcapfs/as/abs\_service/ must exist in USB drive root directory.
- The file called xait.xml must exist in the /hcapfs/as/abs\_service/ folder.
- If the above conditions are not met, the following error message is displayed when selecting the Extra Contents option: Failed to execute file in the USB. Please check the files in the USB.
- When the flash file does not run even if the above all conditions are met, refer to the Download Extra Contents of Installation Guide.
- GEM is composed of JAVA application.

### Playing the application files

1   Select **MY MEDIA**.

2   Select **Extra Contents**.

3  Application files are played.

### To stop playing the Application file

Remove the USB from the **USB IN** jack of the TV set.

#### NOTE

- ▶ When playing the Application files(FLASH or GEM files), the buttons are controlled according to the settings of the Extra Contents option.

# MY MEDIA

## EZSIGN TV

- For 32/42/47LD452B

The EzSign TV function allows you to play and manage high-quality ad content that you create quickly and easily using the EzSign TV Editor.

- For more information of using, refer to the **EzSign TV Editor S/W & Manual**.

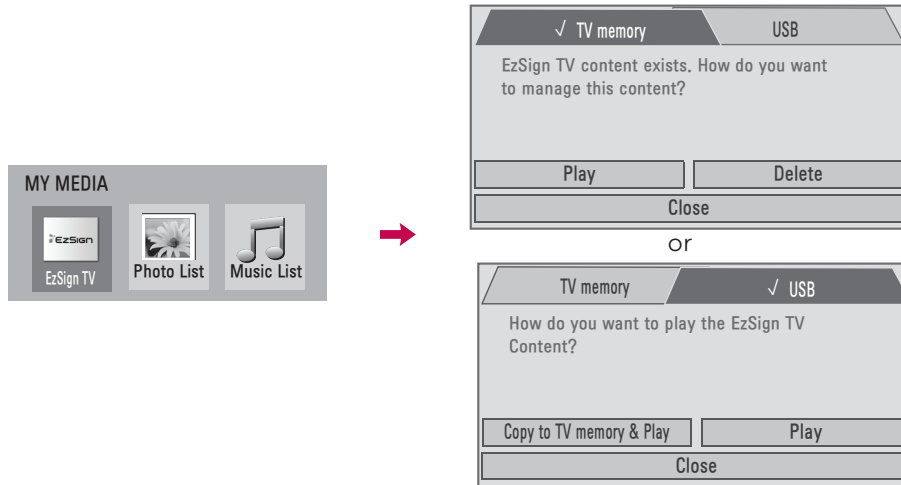

- Select **MY MEDIA**.
- Select **EzSign TV**.

- Select **TV memory** or **USB**.
- Select **Copy to TV memory & Play** or **Play**.

■ The highlighted tab with the "✓" symbol indicates the location of the file currently being played

### TV memory

Play	Plays EzSign TV content in the memory.
Delete	Deletes EzSign TV content from the memory. (Your TV restarts after the content is deleted.)
Close	Closes the EzSign TV menu window.

### USB

Copy to TV memory & Play	Copies a file from the USB memory to the EzSign TV memory and plays it. (Once the file has been copied, it can be played even when it is removed from the USB memory.)
Play	Plays a file directly from the USB memory without copying it to the EzSign TV memory.
Close	Closes the EzSign TV menu window.

### NOTE

- While loading EzSign TV content, your TV may function slower than normal.
- It is recommended that you copy files to the TV memory before playing them, as playing directly from the USB memory for an extended period of time may cause the device to over-heat.
- In EzSign TV, some remote control keys may not work.

# DIVX REGISTRATION CODE

Except 32/42/47LD420, 32/37/42/47LD450, 37/42/47LD450C, 32/42/47/55LD520, 55LD520C, 42/47/55LE530C, 42/47LD451C, 32/37/42/47LD452C, 32/42/47LD452B, 26LD352C

Using the registration number, movies can be rented or purchased at [www.divx.com/vod](http://www.divx.com/vod). Only DivX files matched with the registration code of the purchased TV are playable.

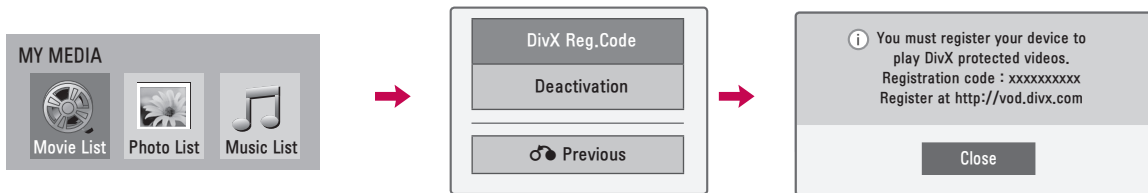

1 Select **MY MEDIA**.

2 Select DivX Option.

3 Select **DivX Reg. Code**.

4 Display DivX Reg. Code.

MY MEDIA

## NOTE

- ▶ When loading, some buttons may not work.
- ▶ If you use the DivX registration code of another device, the rented or purchased DivX file cannot be played. Therefore always use the DivX registration code assigned to this product.
- ▶ The video or audio of a file converted based on a standard other than the DivX codec standard may be corrupted or unable to be played.

# DEACTIVATION

Except 32/42/47LD420, 32/37/42/47LD450, 37/42/47LD450C, 32/42/47/55LD520, 55LD520C, 42/47/55LE530C, 42/47LD451C, 32/37/42/47LD452C, 32/42/47LD452B, 26LD352C

The purpose of deactivation is to allow deactivation of devices for users who have activated all the available devices through the web server and are blocked from activating more devices. DivX VOD allows the consumer to activate up to 6 devices under one account.

Delete the existing authentication information to receive a new DivX user authentication for TV. Once this function is executed, a DivX user authentication is required again to see DivX DRM files.

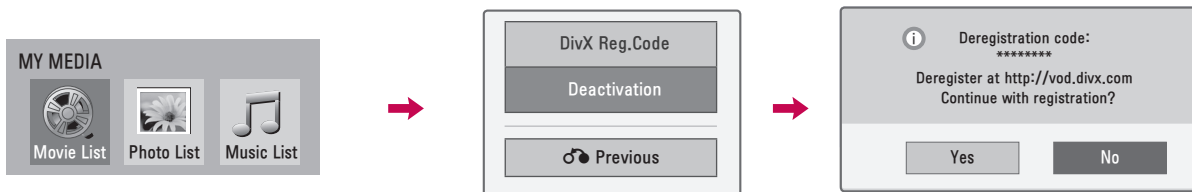

1 Select **MY MEDIA**.

2 Select DivX Option.

3 Select **Deactivation**.

4 Select **Yes**.

5 Display **Deactivation**.

# PICTURE CONTROL

## PICTURE SIZE (ASPECT RATIO) CONTROL

This feature lets you choose the way an analog picture with a 4:3 aspect ratio is displayed on your TV. You can select a different aspect ratio depending on input source (analog broadcasting, digital broadcasting, aux).

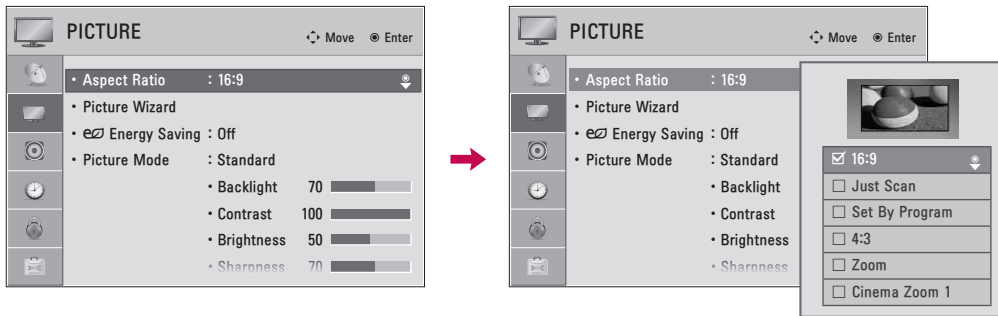

- 1 Select **PICTURE**.
- 2 Select **Aspect Ratio**.
- 3 Select the desired picture format.
- 4 or Return to the previous menu.
- Return to TV viewing.

- You can also adjust **Aspect Ratio** in the **Q.MENU**.
- Press the **RATIO** button repeatedly to select the desired picture format.

## When adjusting Zoom or Cinema Zoom in Q.MENU

- 1 Select **Aspect Ratio**.
- 2 Select **Zoom** or **Cinema Zoom**.
- 3 Adjust proportion of Zoom or Cinema Zoom. The Cinema Zoom adjustment range is 1-16.
- 4 Move the image on the screen.

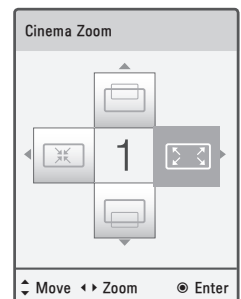
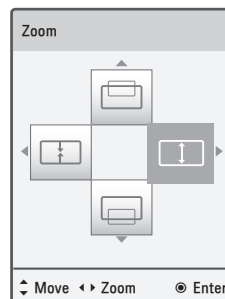

## 16:9

Adjust the picture horizontally, in a linear proportion to fill the entire screen.



## Just Scan

Normally the edges of video signals are cropped 1-2%. Just Scan turns off this cropping and shows the complete video.

Notes: If there is noise on the edges of the original signal, it will be visible when Just Scan is activated.

**Just Scan** operates only in DTV/Cable DTV/Component/HDMI-DTV/DVI-DTV (720p/1080i/1080p) input source.



## Set By Program

Selects the proper picture proportion to match the source's image.

(4:3 → 4:3)



(16:9 → 16:9)



## 4:3

Choose 4:3 when you want to view a picture with an original 4:3 aspect ratio.



## Zoom

Choose Zoom when you want to view the picture without any alteration. However, the top and bottom portions of the picture will be cropped.

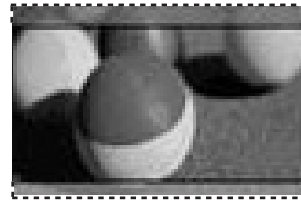

## Cinema Zoom

Choose Cinema Zoom when you want to enlarge the picture in correct proportion.

This enlarges an image with cinemascope aspect ratio (2.35:1) without distortion.

Note: When enlarging or reducing the picture, the image may become distorted.



# PICTURE CONTROL

## PICTURE WIZARD

This feature lets you adjust the picture quality of the original image. Use this to calibrate the screen quality by adjusting the Black and White Level etc. You can calibrate the screen quality by easily following each step. When you adjust the image to **Low**, **Recommended** or **High**, you can see the example of the changes you made.

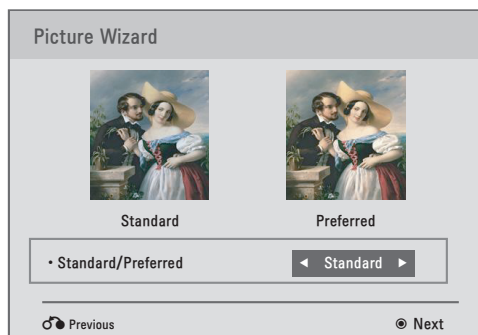
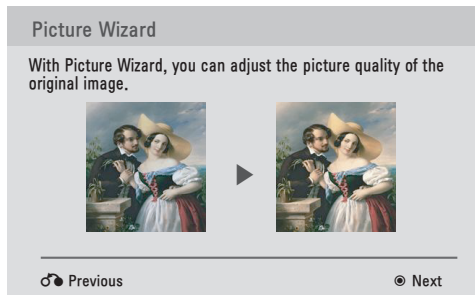
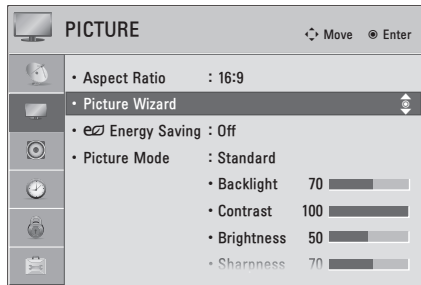

- If you select **Preferred**, OSD (On Screen Display) differ from that shown in this manual.

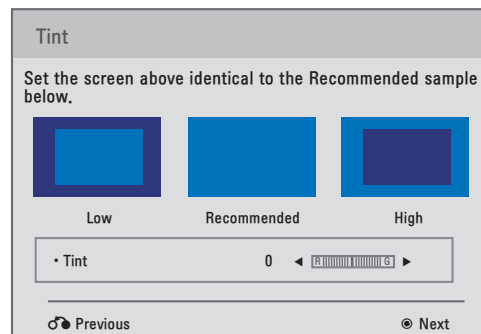
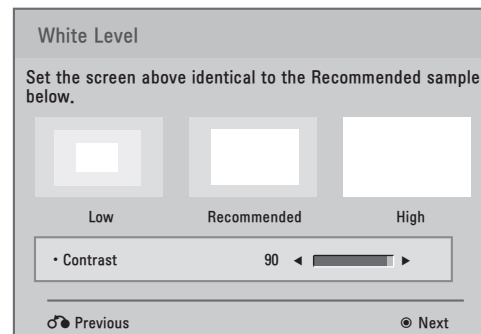
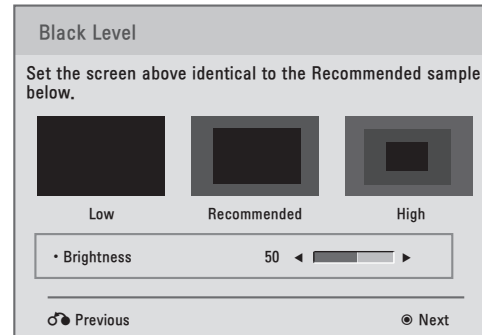

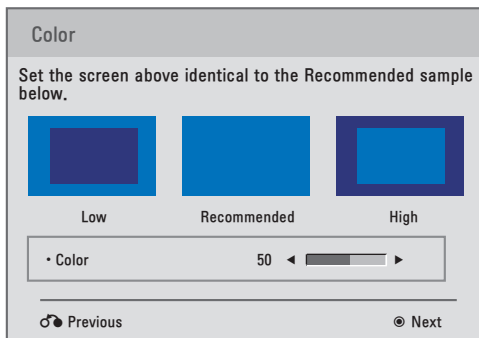

8   Adjust **Color**.

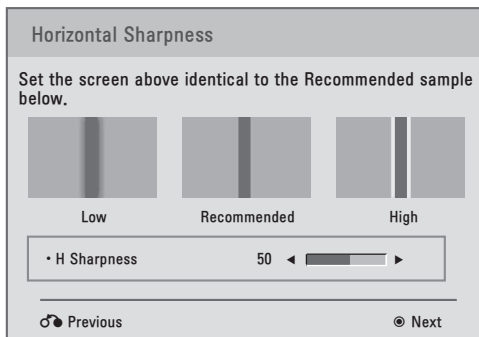

9   Adjust **Horizontal Sharpness**.

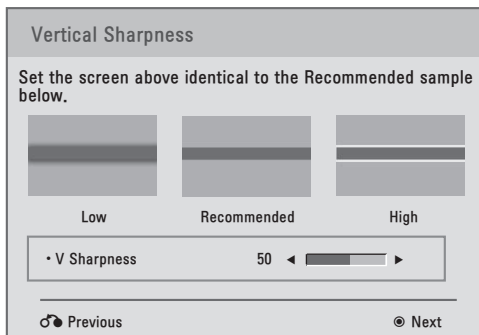

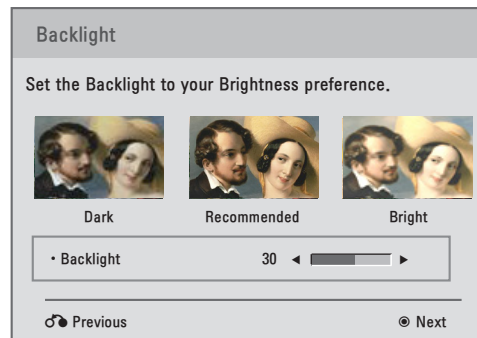

10   Adjust **Vertical Sharpness**.

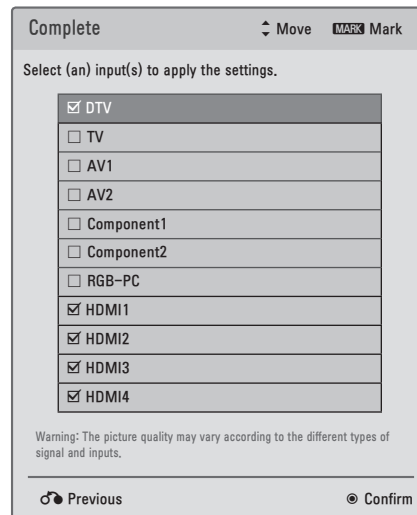

11   Adjust **Backlight**.

i.e)



12   Select input source to apply the settings.

13  Save.

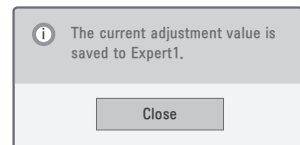

14  Finish the Picture Wizard.

- If you stop the Picture Wizard before the final step, the changes will not be saved to the TV.
- Once the **Picture Wizard** sets the picture quality, **Energy Saving** is changed to **Off** automatically.
- To reset changes made by **Picture Wizard**, operate **Picture Reset** when **Picture Mode** is on **Expert1**.







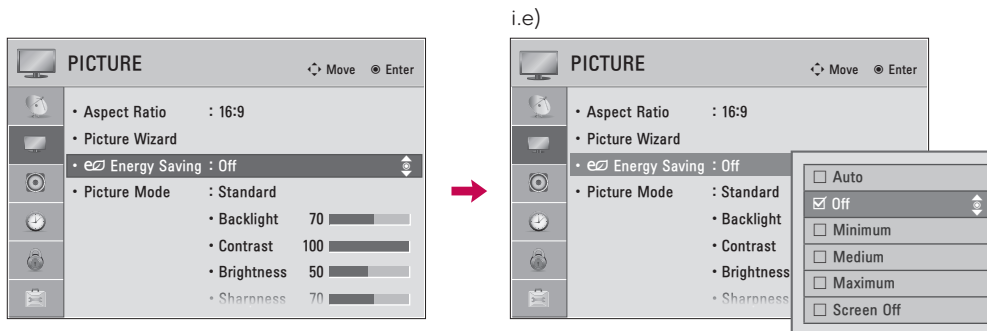

# PICTURE CONTROL

## e ENERGY SAVING

It reduces the TV's power consumption by lowering the backlight level.

You can increase the brightness of your screen by adjusting the **Energy Saving** level or by adjusting the **Picture Mode**.

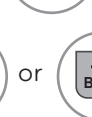





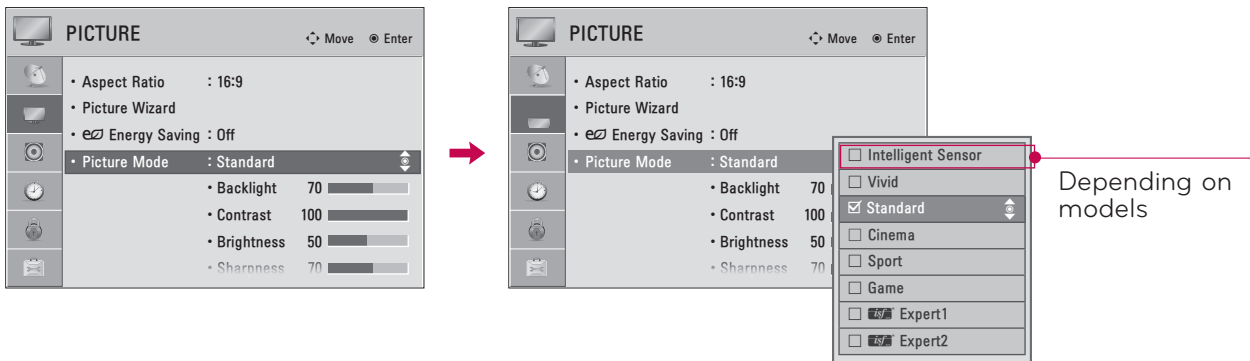

-   Select **PICTURE**.
-   Select **e Energy Saving**.
-   Select **Off, Minimum, Medium, Maximum, or Screen Off**.
-  or  Return to the previous menu.
-  Return to TV viewing.

- When selecting **Screen off**, the screen will turn off after 3 seconds.
- If you adjust "**Energy Saving-Maximum**", **Backlight** feature will not work.
- Press the **ENERGY SAVING** button repeatedly to select the appropriate Energy Saving setup.

# PRESET PICTURE SETTINGS (PICTURE MODE)

There are factory presets for picture settings available in the user menus. You can use a preset, change each setting manually.



- 1   Select **PICTURE**.
  - 2   Select **Picture Mode**.
  - 3   Select **Vivid, Standard, Cinema, Sport, or Game**.
  - 4  or  Return to the previous menu.
-  Return to TV viewing.

- **Vivid, Standard, Cinema, Sport, and Game** Settings are preset for the optimum picture quality at the factory.
- **Vivid:** This is the mode to maximize the effect of the video in the retail store. Strengthen the contrast, brightness, color and sharpness for vivid picture.
- **Standard:** This is the mode to realize optimum viewing condition for the general user.
- **Cinema:** This mode optimizes video for watching movies.
- **Sport:** This is the video mode to emphasize dynamic video and primary color (e.g, white, uniform, grass, sky blue etc.) by realizing the optimal screen for sports.
- **Game:** This is the mode to realize fast response speed in a fast gaming screen.
- **Expert:** This is the mode to adjust the video in detail for video quality expert and general user.
- You can also adjust **Picture Mode** in the **Q.MENU**.
- When selecting **Intelligent Sensor**, **Energy Saving** is changed to **Auto** automatically.
- When selecting **Intelligent Sensor**, it changes Backlight, contrast, brightness, sharpness, color and tint automatically.
- **Intelligent Sensor:** The most suitable picture is automatically adjusted according to the surrounding conditions.

# PICTURE CONTROL

## MANUAL PICTURE ADJUSTMENT - USER MODE

Adjust the picture appearance to suit your preference and viewing situations.

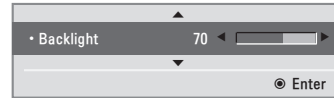
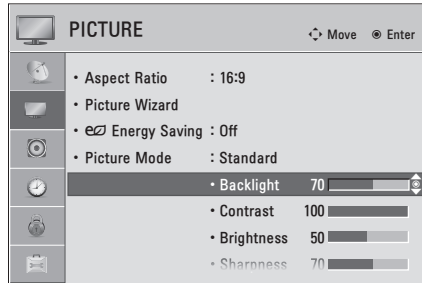









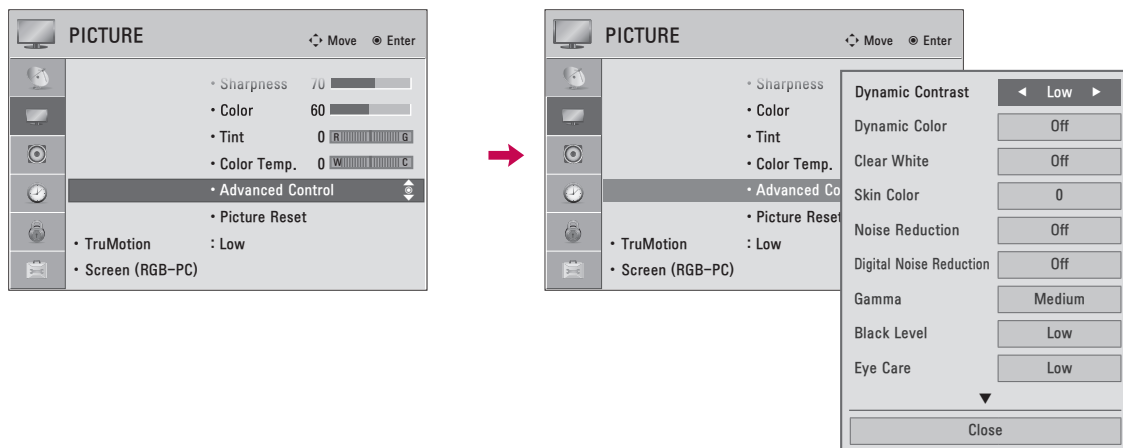

- 1   Select **PICTURE**.
- 2   Select **Picture Mode**.
- 3   Select **Vivid, Standard, Cinema, Sport, or Game**.
- 4   Select **Backlight, Contrast, Brightness, Sharpness, Color, Tint, Color Temp., or Advanced Control**.
- 5   Make appropriate adjustments.
- 6  or  Return to the previous menu.
-  Return to TV viewing.

- **Backlight:** This function adjusts the brightness of the backlight behind the LCD screen. Adjusting the backlight is recommended when setting the brightness of the TV. When decreasing the backlight, the brightness of the black becomes darker without any loss in video signal and the power consumption is reduced.
- **Contrast:** Increase or decrease the gradient of the video signal. You may use Contrast when the bright part of the picture is saturated.
- **Brightness:** Adjusts the base level of the signal in the picture. You may use Brightness when the dark part of the picture is saturated.
- **Sharpness:** Adjusts the level of crispness in the edges between the light and dark areas of the picture. The lower the level, the softer the image.
- **Color:** Adjusts intensity of all colors.
- **Tint:** Adjusts the balance between red and green levels.
- **Color Temp.:** Set to warm to enhance hotter colors such as red, or set to cool to enhance cooler colors such as blue.

# PICTURE IMPROVEMENT TECHNOLOGY (ADVANCED CONTROL)



Advanced Control allows you to adjust some of the advanced features of your LG display. To reset to the factory default after making adjustments to each input source, execute the **Picture Reset** function for each Picture Mode.



- 1   Select **PICTURE**.
- 2   Select **Advanced Control**.
- 3   Select your desired menu option.
- 4  Make appropriate adjustments.
- 5  or  Return to the previous menu.
-  Return to TV viewing.



# PICTURE CONTROL

## EXPERT PICTURE CONTROL

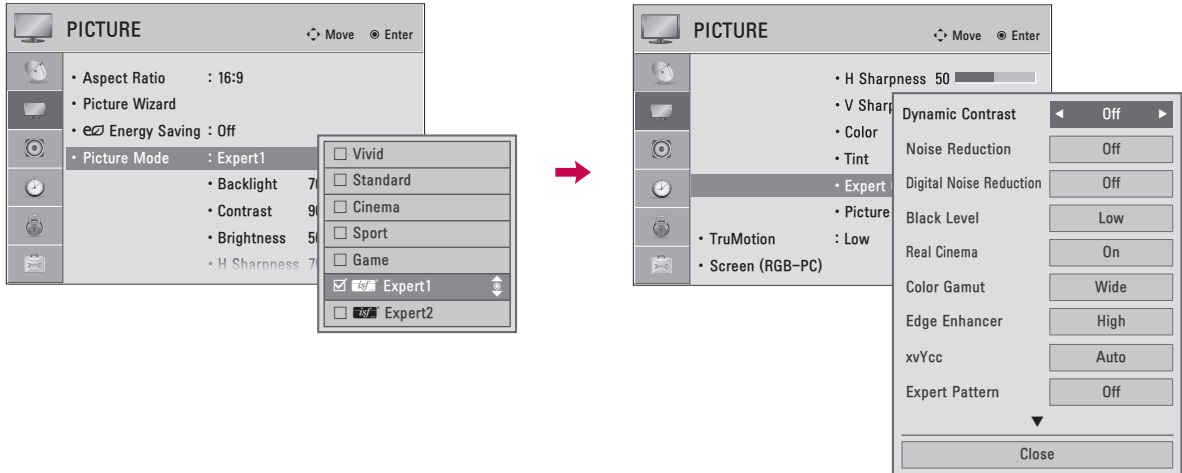
 **Expert1** and  **Expert2** provide even more advanced picture settings for users. Typical used by professionals for calibrating the TV.



PICTURE CONTROL

-   Select **PICTURE**.
-   Select **Picture Mode**.
-   Select  **Expert1** or  **Expert2**.
-   Select **Expert Control**.
-   Select your desired menu option.
-  Make appropriate adjustments.
-  or  Return to the previous menu.
-  Return to TV viewing.

\*This feature is not available for all models.

Dynamic Contrast	<ul style="list-style-type: none"> <li>Adjusts the contrast to keep it at the best level according to the brightness of the screen. The picture is improved by making bright parts brighter and dark parts darker.</li> </ul>
Dynamic Color	<ul style="list-style-type: none"> <li>Adjusts screen colors so that they look livelier, richer and clearer. This feature enhances hue, saturation and luminance so that red, blue and green white look more vivid.</li> </ul>
Skin Color	<ul style="list-style-type: none"> <li>It detects the skin area of video and adjusts it to express a natural skin color.</li> </ul>
Noise Reduction	<ul style="list-style-type: none"> <li>Reduces screen noise without compromising video quality.</li> </ul>
Digital Noise Reduction	<ul style="list-style-type: none"> <li>Removes noise caused by compressing video.</li> </ul>
Gamma	<ul style="list-style-type: none"> <li>You can adjust brightness of dark areas and middle gray level areas of the picture.</li> </ul> <p>Low : Make brighter and middle gray level areas of the picture brighter.          Medium : Express original picture levels.          High: Make dark and middle gray level areas of the picture darker.</p>
Black Level	<p>Low: The reflection of the screen gets darker.          High: The reflection of the screen gets brighter.</p> <ul style="list-style-type: none"> <li>Set black level of the screen to proper level.</li> <li>This function is available in the following modes: AV (NTSC-M), HDMI or Component.</li> </ul>
Clear White	<ul style="list-style-type: none"> <li>Make the white area of screen brighter and more white.</li> </ul>
Eye Care	<ul style="list-style-type: none"> <li>Adjust the brightness of the screen to prevent the screen from being too bright. Dims extremely bright pictures.</li> <li>This feature is enabled in "<b>Picture Mode-Standard, Sports, Game</b>".</li> </ul>
Real Cinema	<ul style="list-style-type: none"> <li>Makes video clips recorded in film look more natural by eliminating judder effect.</li> <li>DVD and Blu-ray movies are filmed at 24 frames per second (fps). With LG Real Cinema, every frame is consistently processed 5 times in 1/24 of a second producing 120 fps with TruMotion or 2 times in 1/24 of a second producing 48 fps without TruMotion, thus totally eliminating the judder effect.</li> <li>This function can also work when TruMotion is off.</li> </ul>
Color Gamut	<p><b>Advanced Control</b></p> <ul style="list-style-type: none"> <li>Maximize the utilization of colors to increase color quality.</li> </ul> <p>Standard: Displays standard set of colors.          Wide: Increase number of colors used.</p> <hr/> <p>LED LCD TV/LCD TV: <b>Expert Control</b></p> <ul style="list-style-type: none"> <li>Displays color domain of the signal.</li> </ul> <p>Standard: Displays standard set of colors.          Wide: Increase number of colors used.          EBU: Mode to display EBU standard color area.          SMPTE: Mode to display SMPTE standard color area.          BT709: Mode to display BT709 standard color area.</p>

# PICTURE CONTROL

Edge Enhancer	<ul style="list-style-type: none"> <li>■ Show clearer and distinctive yet natural edges in of the video.</li> <li>■ This function is enabled in "<b>Picture Mode - Expert</b>".</li> </ul>
xvYCC	<ul style="list-style-type: none"> <li>■ This produces richer colors.</li> <li>■ This feature represents rich color as much as conventional video signal.</li> <li>■ This function is enabled in "<b>Picture Mode - Cinema, Expert</b>" when a xvYCC signal is inputted through HDMI.</li> </ul>
Color Filter	<ul style="list-style-type: none"> <li>■ This function filters specific colors in the video. You can use the RGB filter to set color saturation and hue accurately.</li> </ul>
Expert Pattern	<ul style="list-style-type: none"> <li>■ This is a pattern used for expert adjustment.</li> <li>■ This function is enabled in "<b>Picture Mode - Expert</b>" when you watch DTV.</li> </ul>
Color Temperature	<ul style="list-style-type: none"> <li>■ Adjusts the overall color of the screen by changing the white baseline.             <ol style="list-style-type: none"> <li>a. Gamma : Select 1.9, 2.2, 2.4</li> <li>b. Method : 2 Points                 <ul style="list-style-type: none"> <li>- Pattern: Inner, Outer</li> <li>- Red/Green/Blue Contrast, Red/Green/Blue Brightness: The adjustment range is -50 - +50.</li> </ul> </li> <li>c. Method : 10 Point IRE                 <ul style="list-style-type: none"> <li>- Pattern: Inner, Outer</li> <li>- IRE (Institute of Radio Engineers) is the unit to display the size of the video signal and can be set among 10, 20, 30 - 100. You can adjust Red, Green or Blue according to each setting.</li> <li>- Luminance: This function displays calculated luminance value for 2.2 gamma. You can input luminance value you want at 100 IRE, then the target luminance value for 2.2 gamma is displayed at every 10 steps from 10 IRE to 90 IRE.</li> <li>- Red/Green/Blue: The adjustment range is -50 - +50.</li> </ul> </li> <li>d. Apply to all inputs</li> </ol> </li> </ul>
Color Management System	<ul style="list-style-type: none"> <li>■ A tool used by the experts to make adjustments by using the test patterns, this does not affect other colors but can be used to selectively adjust the 6 color areas (Red/Green/Blue/Cyan/Mgt/Yellow). Color difference may not be distinctive even when you make the adjustments for the general video.</li> </ul> <p>Adjusts Red/Green/Blue/Yellow/Cyan/Magenta.</p> <ul style="list-style-type: none"> <li>- Red/Green/Blue/Yellow/Cyan/Magenta Color: The adjustment range is -30 - +30.</li> <li>- Red/Green/Blue/Yellow/Cyan/Magenta Tint: The adjustment range is -30 - +30.</li> <li>- This feature is disabled in RGB-PC and HDMI-PC mode.</li> </ul>

## PICTURE RESET

Settings of the selected picture modes return to the default factory settings.

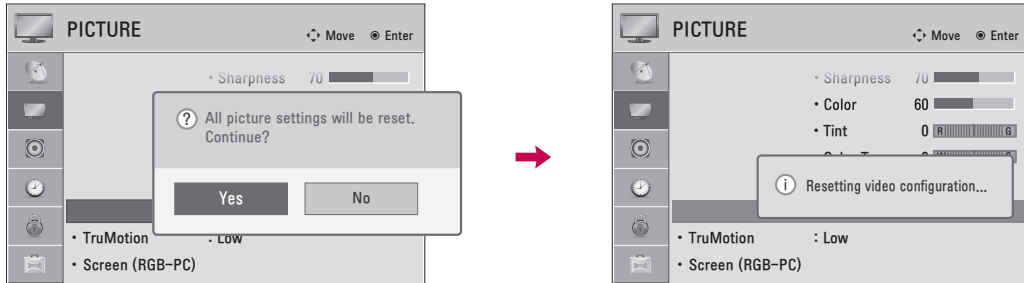

- 1 Select **PICTURE**.
- 2 Select **Picture Reset**.
- 3 Select **Yes**.
- 4 Initialize the adjusted value.
- Return to TV viewing.

## POWER INDICATOR

Adjust the power/standby indicator light on the front of the TV.

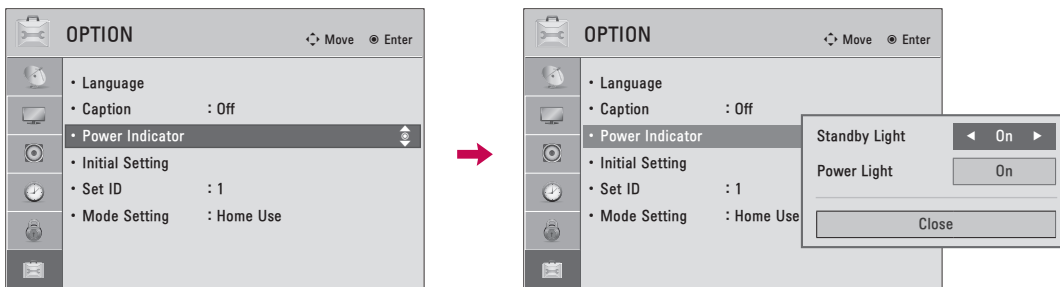

- 1 Select **OPTION**.
- 2 Select **Power Indicator**.
- 3 Select **Standby Light** or **Power Light**.
- 4 Select your desired options.
- 5 or Return to the previous menu.
- Return to TV viewing.

- **Standby Light:** Determines whether to set the indicator light on the front of the TV to **On** or **Off** in standby mode.
- **Power Light:** Determines whether to set the indicator light on the front of the TV to **On** or **Off** when the power turns on.

# PICTURE CONTROL

## TRUMOTION

- For 32/37/42/47/55LE5300, 42/47/55LE7300, 32/42/47/55LD520, 55LD520C, 42/47/55LD630, 42/47/55LE530C

Advance video technology that provides clearer, smoother images, even during fast action scenes creating a more stable structure for a crisper picture.

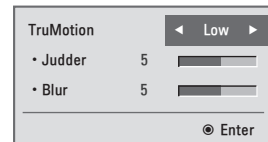
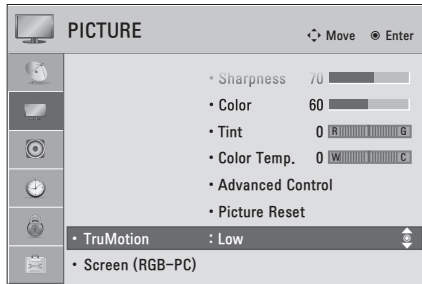

- 1 Select **PICTURE**.
- 2 Select **TruMotion**.
- 3 Select **Low, High, User, or Off**.

### Adjustment for TruMotion (Judder and Blur) with selecting User

- 4 Select **Judder** or **Blur**.
- 5 Make appropriate adjustments.
- 6 or Return to the previous menu.
- Return to TV viewing.

- **Off**: Turn off **TruMotion** operation.
- **Low**: Provides smooth picture movement. Use this setting for standard use.
- **High**: Provides smoother picture movement.
- **Judder**: Adjusts noise of the screen.
- **Blur**: Adjusts after-image of the screen.
- **TruMotion** works with all inputs except PC mode.
- If you enable "**TruMotion**", noise may appear on the screen. If this occurs, set "**TruMotion**" to "**Off**".
- If you select "**Picture Mode-Game**" set "**TruMotion**" to "**Off**".







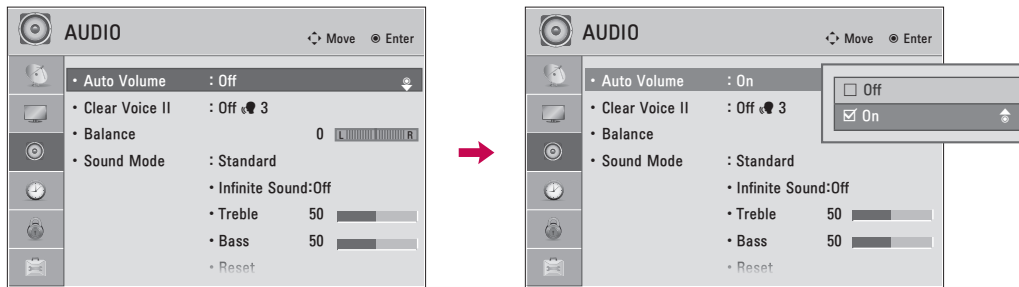

# SOUND & LANGUAGE CONTROL

## AUTO VOLUME

Auto Volume makes sure that the volume level remains consistent whether you are watching a commercial or a regular TV program.

Because each broadcasting station has its own signal conditions, volume adjustment may be needed every time the channel is changed. This feature allows users to enjoy stable volume levels by making automatic adjustments for each program.







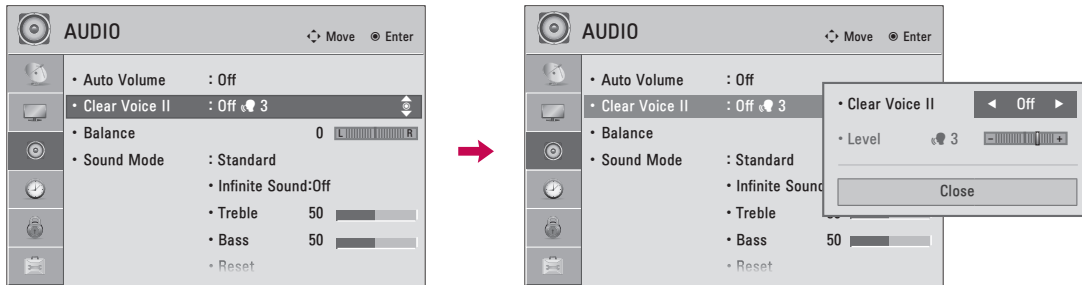

-   Select **AUDIO**.
-   Select **Auto Volume**.
-   Select **On** or **Off**.
-  or  Return to the previous menu.
-  Return to TV viewing.

# SOUND & LANGUAGE CONTROL





## CLEAR VOICE II

By differentiating the human sound range from others, it improves the sound quality of voices.



- 1   Select **AUDIO**.
- 2   Select **Clear Voice II**.
- 3   Select **On** or **Off**.







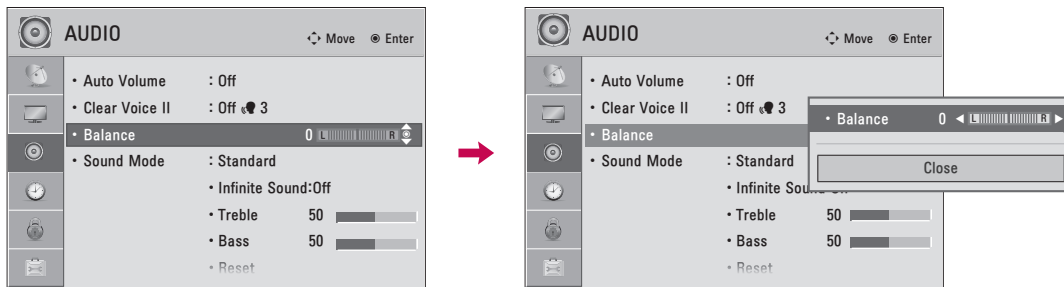

### Adjustment for Clear Voice Level with selecting On

- 4  Select **Level**.
- 5  Make appropriate adjustments.
- 6  or  Return to the previous menu.
-  Return to TV viewing.

# BALANCE

Adjust the left/right sound of speaker to suit your taste and room situations.



-   Select **AUDIO**.
-   Select **Balance**.
-   Make appropriate adjustments.
-  or  Return to the previous menu.
-  Return to TV viewing.

# SOUND & LANGUAGE CONTROL

## PRESET SOUND SETTINGS (SOUND MODE)

Sound Mode lets you enjoy the best sound without any special adjustment using factory presets.

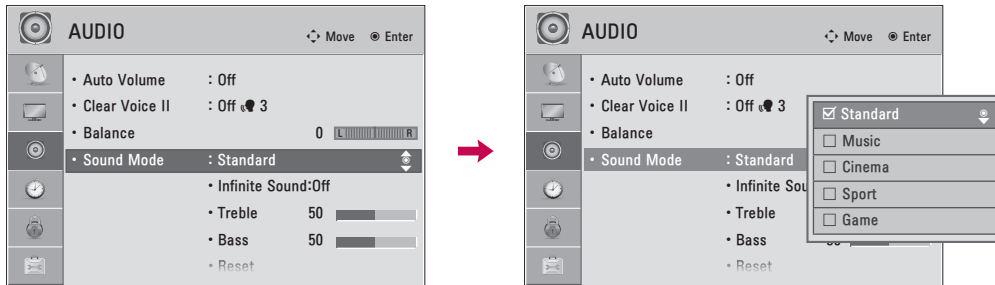

- 1 Select **AUDIO**.
- 2 Select **Sound Mode**.
- 3 Select **Standard, Music, Cinema, Sport, or Game**.
- 4 or Return to the previous menu.
- Return to TV viewing.

- **Standard, Music, Cinema, Sport, and Game** are preset for optimum sound quality at the factory.
- You can also adjust **Sound Mode** in the **Q.MENU**.
- **Standard**: Offers standard-quality sound.
- **Music**: Optimizes sound for listening to music.
- **Cinema**: Optimizes sound for watching movies.
- **Sport**: Optimizes sound for watching sports events.
- **Game**: Optimizes sound for playing games.

# SOUND SETTING ADJUSTMENT - USER MODE

Adjust the sound to suit your taste and room situations.

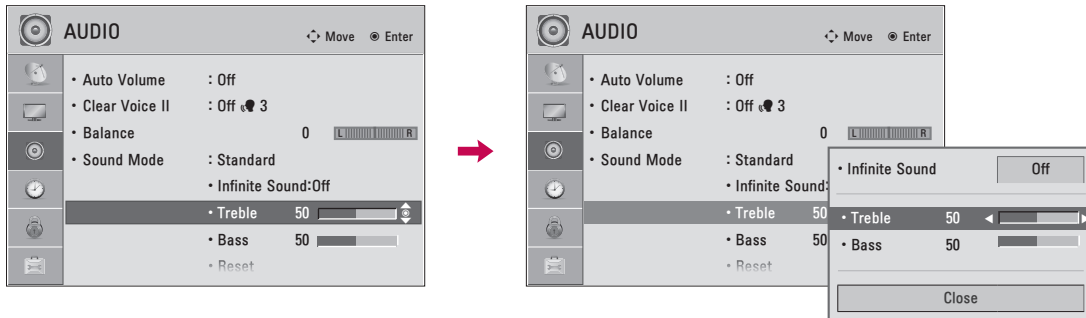

- 1 Select **AUDIO**.
- 2 Select **Sound Mode**.
- 3 Select **Standard, Music, Cinema, Sport, or Game**.
- 4 Select **Infinite Sound, Treble, or Bass**.
- 5 Make appropriate adjustments.
- 6 or Return to the previous menu.
- Return to TV viewing.









- If sound quality or volume is not at the level you want, it is recommended to use a separate home theater system or amp to cope with different user environments.
- If you select "Clear Voice II-On", the **Infinite Sound** feature will not operate.
- **Infinite Sound**: Infinite Sound is a patented LG proprietary sound processing technology that strives immersive 5.1 surround sound with just two front speakers.

# SOUND & LANGUAGE CONTROL

## AUDIO RESET

Settings of the selected Sound Mode return to the default factory settings.



-   Select **AUDIO**.
-   Select **Reset**.
-   Select **Yes**.
-  Initialize the adjusted value.
-  Return to TV viewing.

## TV SPEAKERS ON/OFF SETUP

If you wish to use an external Hi-Fi system, turn off the TV's internal speakers.

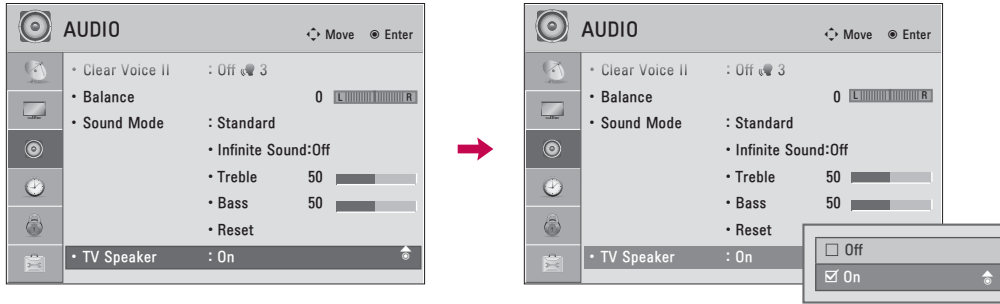

- 1 Select **AUDIO**.
- 2 Select **TV Speaker**.
- 3 Select **On** or **Off**.
- 4 or Return to the previous menu.
- Return to TV viewing.

## EXTERNAL SPEAKERS ON/OFF SETUP

(For 32/37/42/47LD450C, 32/37/47/47LD452C, 32/42/47LD452B, 26LD352C)

Turn the external speakers on if using external audio equipment.

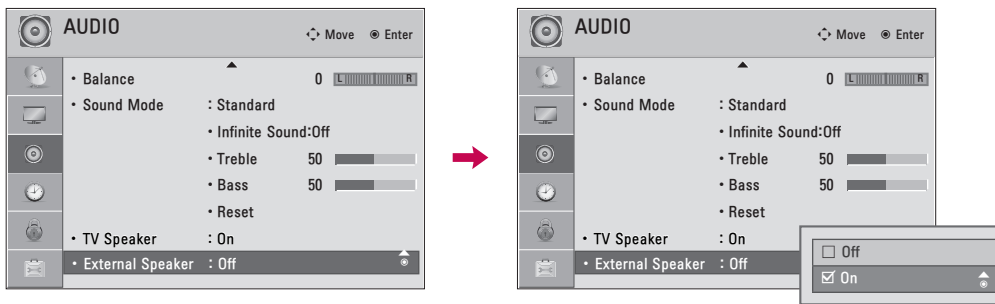

- 1 Select **AUDIO**.
- 2 Select **External Speaker**.
- 3 Select **On** or **Off**.
- 4 or Return to the previous menu.
- Return to TV viewing.





# SOUND & LANGUAGE CONTROL

## STEREO/SAP BROADCAST SETUP





On analog signals, this TV can receive MTS stereo programs and any SAP (Secondary Audio Program) that accompanies the stereo program if the station transmits an additional sound signal. Mono sound is automatically used if the broadcast is only in Mono.



### Analog TV

- 1   Select **SAP**.
- 2   Select **Mono, Stereo, or SAP**.
- 3  Return to TV viewing.









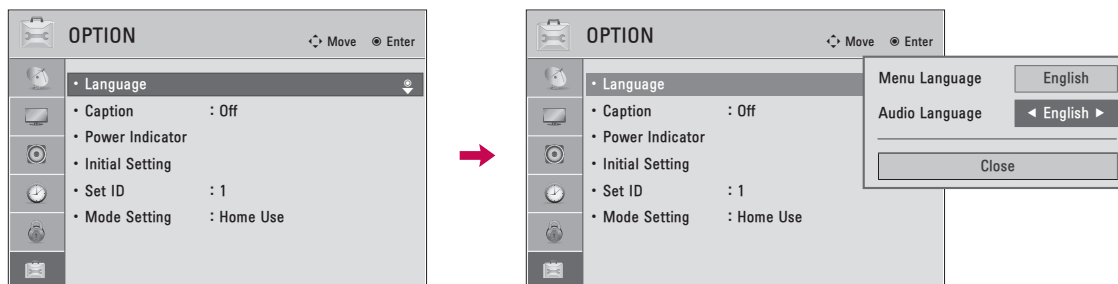

### Digital TV

- 1   Select **Multi Audio**.
- 2   Select other languages.
- 3  Return to TV viewing.

# AUDIO LANGUAGE

This feature operates only in DTV/Cable DTV mode.











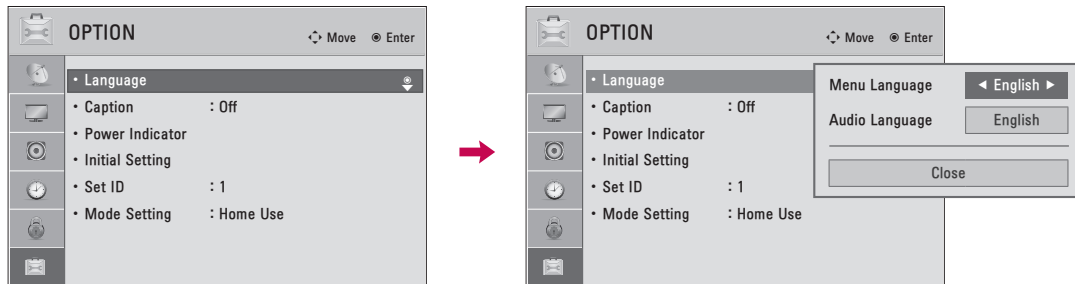

-   Select **OPTION**.
-   Select **Language**.
-   Select **Audio Language**.
-  Select your desired language.
-  or  Return to the previous menu.
-  Return to TV viewing.

# SOUND & LANGUAGE CONTROL

## ON-SCREEN MENUS LANGUAGE SELECTION

The menus can be shown on the screen in the selected language.











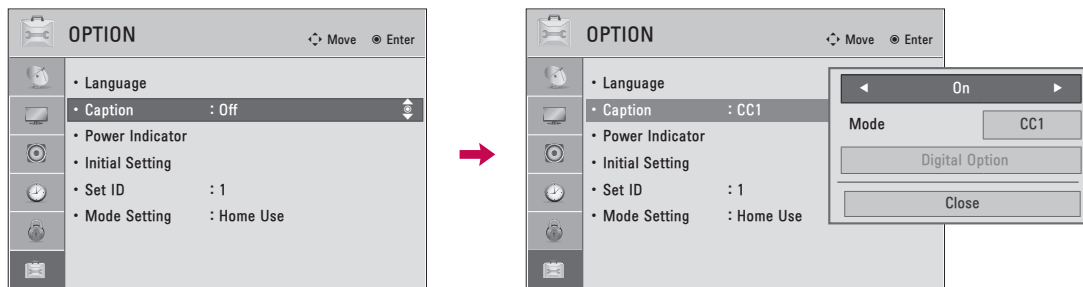



-   Select **OPTION**.
-   Select **Language**.
-   Select **Menu Language**.
-  Select your desired language.  
From this point on, the on-screen menus will be shown in the selected language.
-  or  Return to the previous menu.
-  Return to TV viewing.

# CAPTION MODE

## Analog Broadcasting System Captions

Captions are provided to help the hearing impaired watch TV. Select a caption mode for displaying captioning information if provided on a program. Analog caption displays information at any position on the screen and is usually the program's dialog. Caption/Text, if provided by the broadcaster, would be available for both digital and analog channels on the Antenna/Cable. This TV is programmed to memorize the caption/text mode which was last set when you turned the power off. This function is only available when **Caption Mode** is set **On**.



- 1   Select **OPTION**.
- 2   Select **Caption**.
- 3   Select **On**.
- 4   Select **CC1-4** or **Text1-4**.
- 5  or  Return to the previous menu.
-  Return to TV viewing.

- When selecting **Off**, Sub-menus for Analog, DTV, and Digital Option become disabled.

- **Caption**

The term for the words that scroll across the bottom of the TV screen; usually the audio portion of the program provided for the hearing impaired.

- **Text**









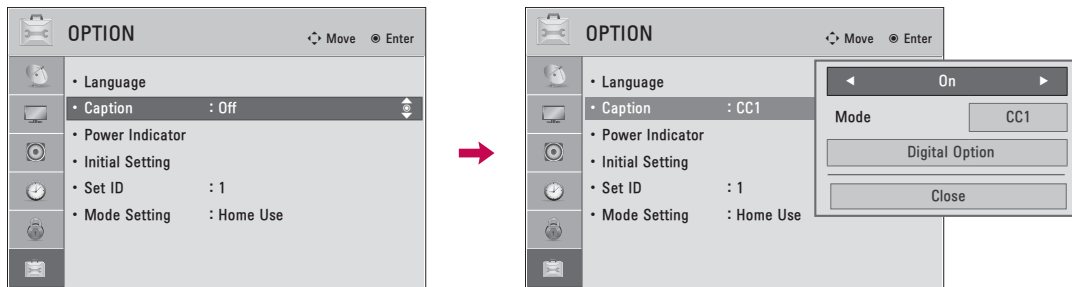

The term for the words that appear in a large black frame and almost cover the entire screen; usually messages provided by the broadcaster.

# SOUND & LANGUAGE CONTROL

## Digital Broadcasting System Captions

Choose the language you want the DTV/Cable DTV Captions to appear in.  
Other Languages can be chosen for digital sources only if they are included on the program.  
This function is only available when **Caption Mode** is set **On**.



- 1   Select **OPTION**.
- 2   Select **Caption**.
- 3   Select **On**.
- 4   Select **CC1-4, Text1-4, or Service1 - 6**.
- 5  or  Return to the previous menu.
-  Return to TV viewing.

## Caption Option

Customize the DTV/Cable DTV captions that appear on your screen.

This function is only available when **Caption Mode** is set **On**.

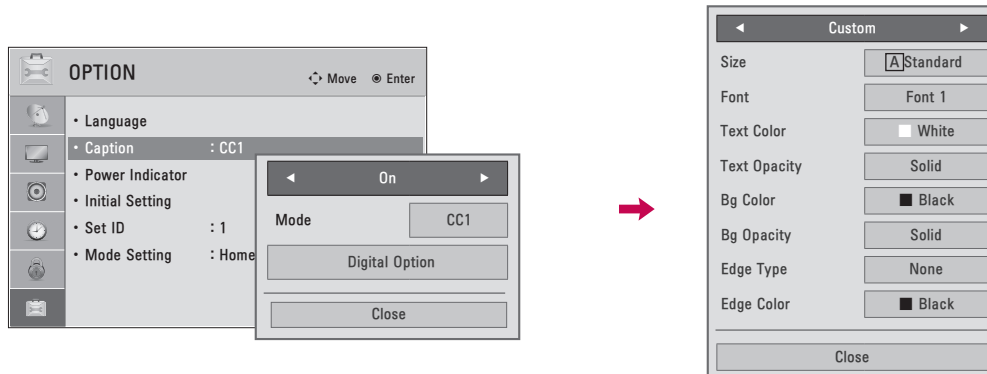

1 Select **OPTION**.

2 Select **Caption**.

3 Select **On**.

4 Select **Digital Option**.

5 Select **Custom**.

6 Customize the **Size**, **Font**, etc., to your preference. A preview icon is provided at the bottom of the screen, use it to see the caption language.

7 or Return to the previous menu.

Return to TV viewing.

- **Size:** Set the word size.
- **Font:** Select a typeface for the text.
- **Text Color:** Choose a color for the text.
- **Text Opacity:** Specify the opacity for the text color.
- **Bg (Background) Color:** Select a background color.
- **Bg (Background) Opacity:** Select the opacity for the background color.
- **Edge Type:** Select an edge type.
- **Edge Color:** Select a color for the edges.

# TIME SETTING

## CLOCK SETTING









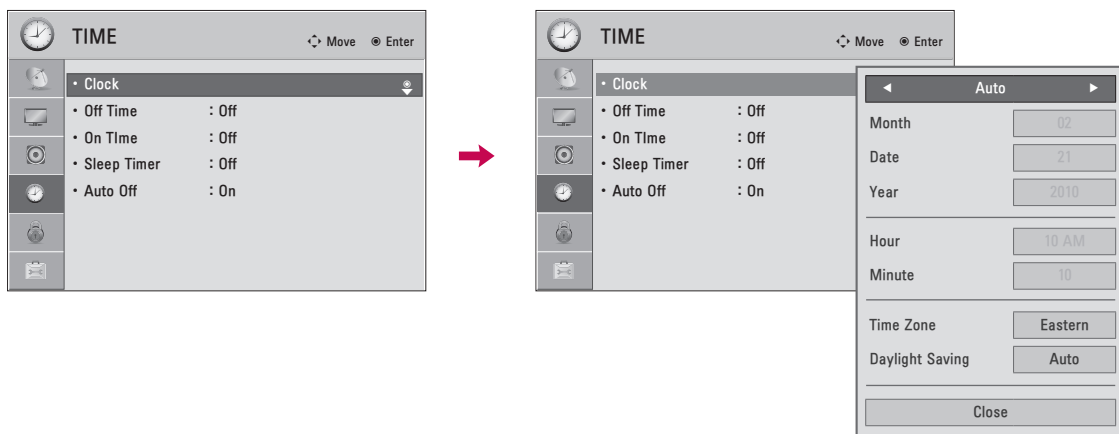



### Auto Clock Setup

The time is set automatically from a digital channel signal.

The digital channel signal includes information for the current time provided by the broadcasting station.

Set the clock manually if the current time is set incorrectly by the auto clock function.









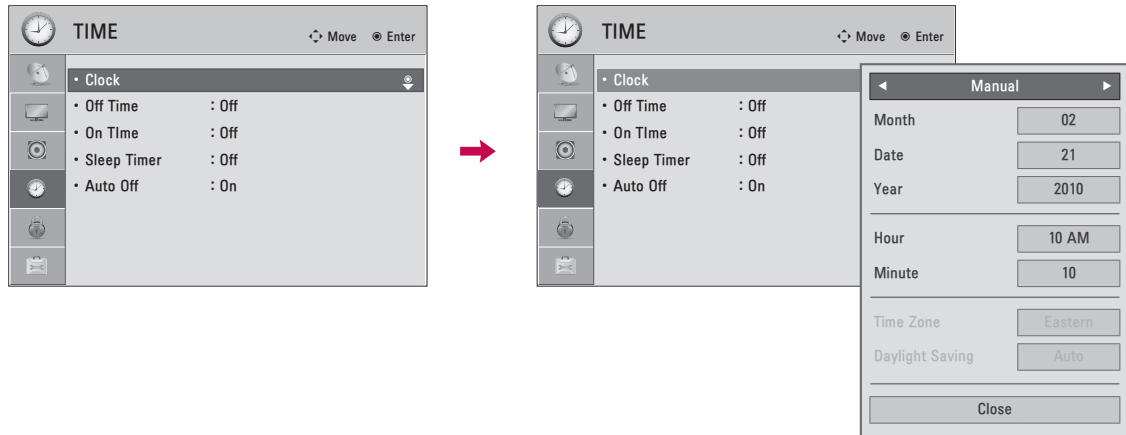



-   Select **TIME**.
-   Select **Clock**.
-   Select **Auto**.
-   Select your viewing area time zone.  
**USA: Eastern, Central, Mountain, Pacific, Alaska, or Hawaii.**  
**Canada: Eastern, Central, Mountain, Pacific, New Foundland, or Atlantic.**
-   Select **Auto, Off, or On** (depending on whether or not your viewing area observes Daylight Saving time).
-  or  Return to the previous menu.
-  Return to TV viewing.

## Manual Clock Setup

If the current time setting is wrong, reset the clock manually.



-   Select **TIME**.
-   Select **Clock**.
-   Select **Manual**.
-  Select the Year, Month, Date, Hour, or Minute option.
-  Set the Year, Month, Date, Hour, or Minute option.
-  or  Return to the previous menu.
-  Return to TV viewing.

# TIME SETTING

## AUTO ON/OFF TIME SETTING

This function operates only if the current time has been set.

The **Off Time** function overrides the **On Time** function if they are both set to the same time.

The TV must be in standby mode for the **On Time** to work.

If you do not press any button within 2 hours after the TV turns on with the **On Time** function, the TV will automatically revert to standby mode. (Except 42/47LD450C, 55LD520C, 42/47/55LE530C, 42/47LD452C, 42/47LD452B, 26LD352C)

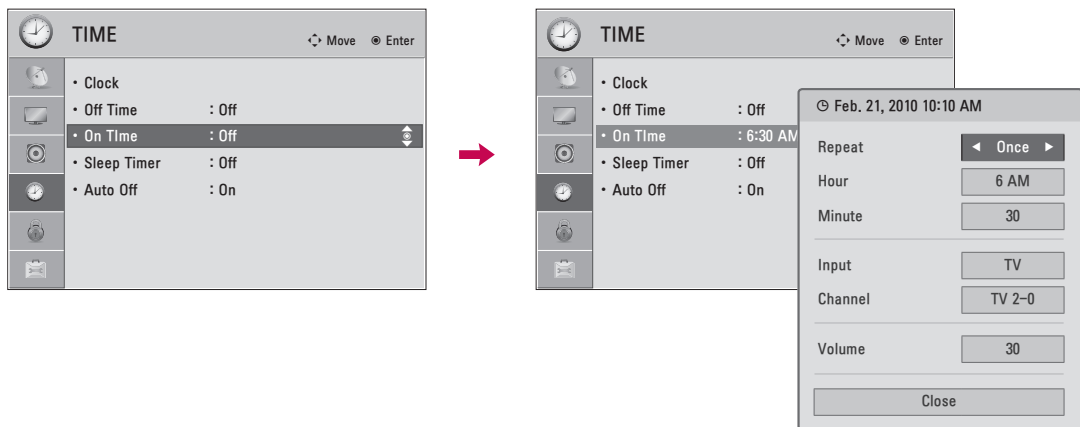

- 1 Select **TIME**.
- 2 Select **Off Time** or **On Time**.
- 3 Select **Repeat**.
- 4 Select **Off**, **Once**, **Daily**, **Mon.-Fri.**, **Mon.-Sat.**, **Sat.-Sun.**, or **Sun.**.
- 5 Select and set Hour or Minute.
- 6 or Return to the previous menu.
- Return to TV viewing.

- To cancel **On/Off Time** function, select **Off**.
  - Only for **On Time** function
- 1 Select **Input**.
  - 2 Select the desired input source.
  - 3 When Selecting **TV**: set the channel at turn-on.
  - 4 Adjust to sound level at turn-on.

## SLEEP TIMER SETTING

The Sleep Timer turns the TV off at the preset time.  
 Note that this setting is cleared when the TV is turned off.

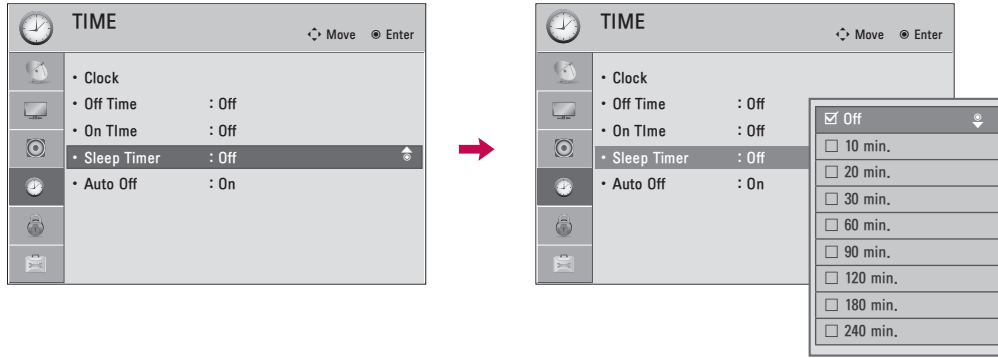

- 1 Select **TIME**.
- 2 Select **Sleep Timer**.
- 3 Make appropriate adjustments.

- 4 or Return to the previous menu.
- Return to TV viewing.

- To cancel the **Sleep Timer**, select **Off**.
- You can also adjust **Sleep Timer** in the **Q.MENU**.

## AUTO SHUT-OFF SETTING

For 37/42/47LD450C, 55LD520C, 42/47LD451C, 32/37/42/47LD452C, 32/42/47LD452B, 26LD352C  
 If set to on and there is no input signal, the TV turns off automatically after 15 minutes.

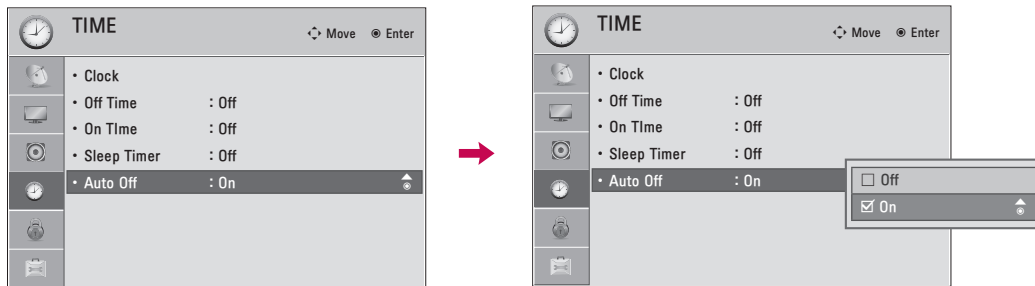

- 1 Select **TIME**.
- 2 Select **Auto Off**.
- 3 Select **On** or **Off**.

- 4 or Return to the previous menu.
- Return to TV viewing.

# PARENTAL CONTROL / RATINGS

Parental Control can be used to block specific channels, ratings and other viewing sources.

The Parental Control Function (V-Chip) is used to block program viewing based on the ratings sent by the broadcasting station. The default setting is to allow all programs to be viewed. Viewing can be blocked by choosing the type of the program and the categories. It is also possible to block all program viewing for a time period. To use this function, the following must be done :

1. Set ratings and categories to be blocked.
2. Specify a password
3. Enable the lock

## V-Chip rating and categories

Rating guidelines are provided by broadcasting stations. Most television programs and television movies can be blocked by TV Rating and/or Individual Categories. Movies that have been shown at the theaters or direct-to-video movies use the Movie Rating System (MPAA) only.

## Ratings for Television programs including made-for-TV movies:





- TV-G (General audience)
- TV-PG (Parental guidance suggested)
- TV-14 (Parents strongly cautioned)
- TV-MA (Mature audience only)
- TV-Y (All children)
- TV-Y7 (Children 7 years older)

## SET PASSWORD & LOCK SYSTEM

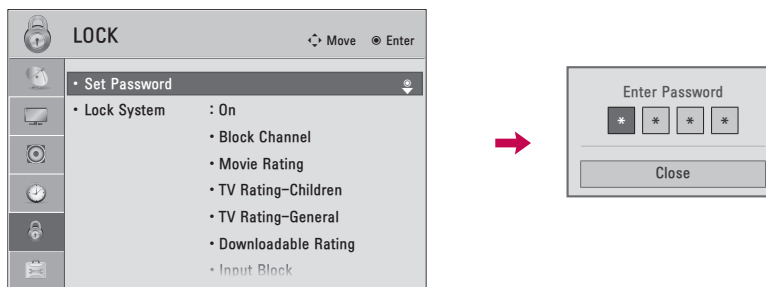
### Setting up Your Password

Set up blocking schemes to block specific channels, ratings, and external viewing sources. A password is required to gain access to this menu.





1.    Select **LOCK**.
2.  Input the password.

- Enter the password as requested.
- The TV is set up with the initial password "0-0-0-0".
- If you forget your password, press "0-3-2-5" on the remote control.

## Set Password

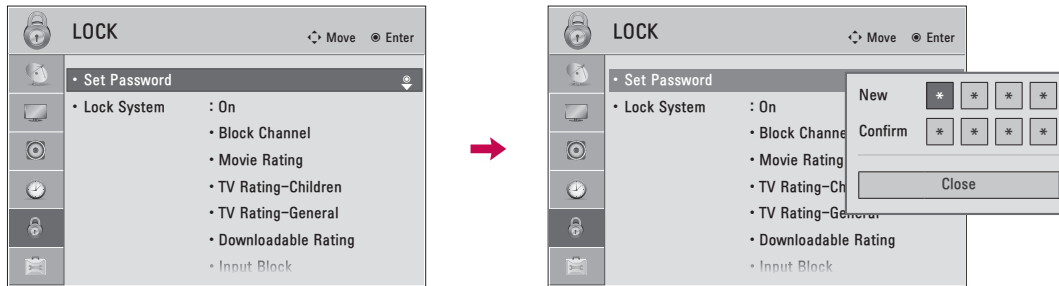

Change the password by inputting a new password twice.





1    Select **LOCK**.

2  Input the password.

3  Select **Set Password**.

4   Choose any 4 digits for your new password.  
As soon as the 4 digits are entered, re-enter the same 4 digits on the **Confirm**.

5  or  Return to the previous menu.









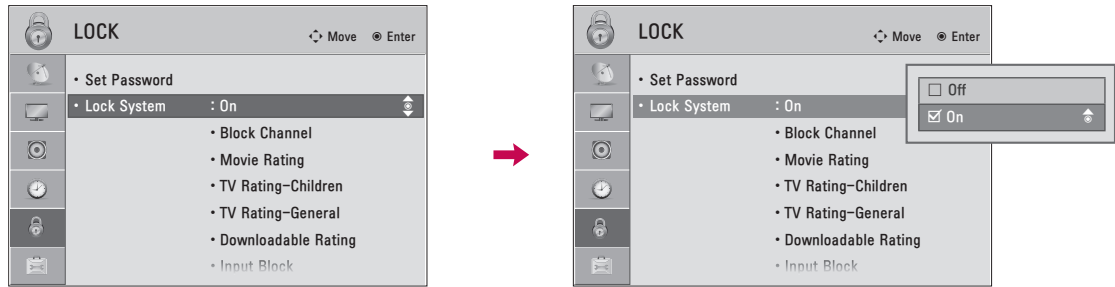

 Return to TV viewing.

# PARENTAL CONTROL / RATINGS

## Lock System

Enables or disables the blocking scheme you set up previously.







-    Select **LOCK**.
-  Input the password.
-  Select **Lock System**.
-   Select **On** or **Off**.
-  or  Return to the previous menu.
-  Return to TV viewing.

■ When you select **On**, the Lock System is enable.

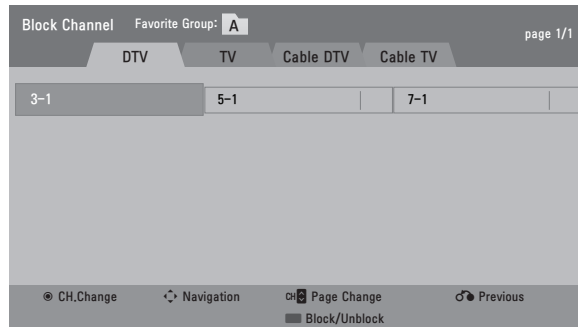
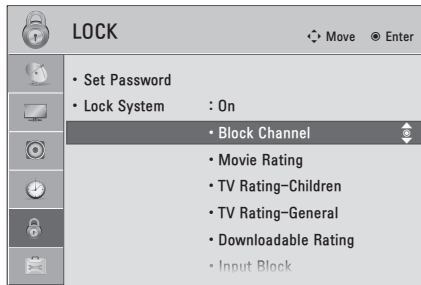
# CHANNEL BLOCKING



Blocks any channels that you do not want to watch or that you do not want your children to watch.





1    Select **LOCK**.

2  Input the password.

3  Select **Block Channel**.

4   Select a channel to block or unblock.

5  Block or unblock a channel.

6  or  Return to the previous menu.

 Return to TV viewing.

■ If a channel is locked, enter the password to unlock it temporarily.









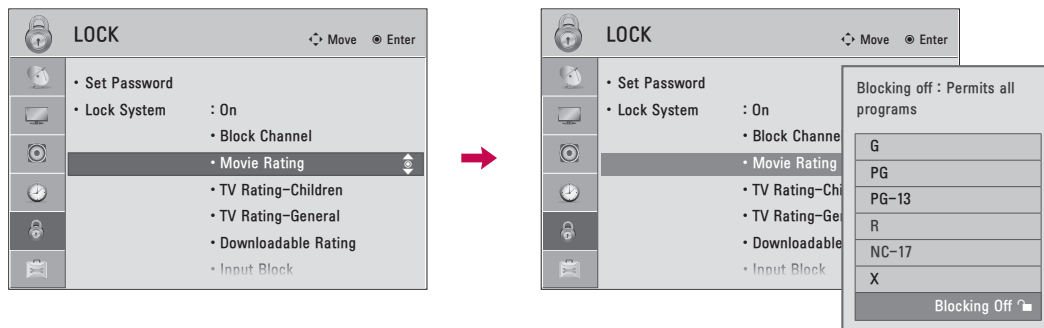

# PARENTAL CONTROL / RATINGS

## MOVIE & TV RATING

### Movie Rating (MPAA)- For USA

Blocks movies according to the movie ratings limits specified, so children cannot view certain movies. You can set the ratings limit by blocking out all the movies with the ratings above a specified level. Keep in mind that the movie ratings limit only applies to movies shown on TV, not TV programs, such as soap operas.











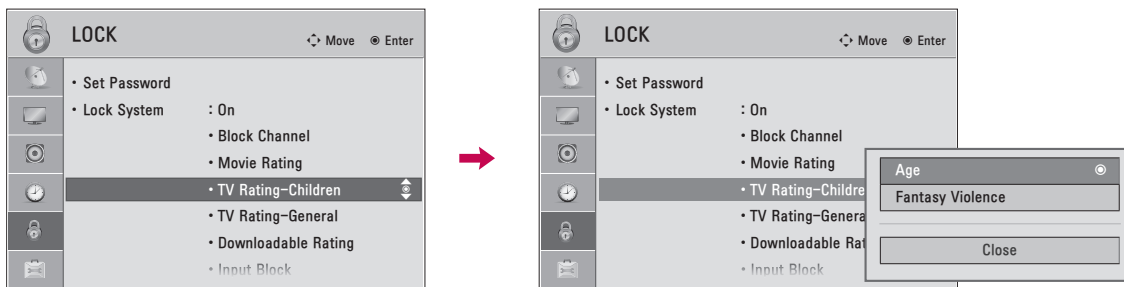



-    Select **LOCK**.
-  Input the password.
-  Select **Movie Rating**.
-   Select **G, PG, PG-13, R, NC-17, X, or Blocking Off**.
-  or  Return to the previous menu.
-  Return to TV viewing.

- If **Movie Rating, TV Rating-Children** or **TV Rating-General** is locked, enter the password to unlock it temporarily.
- **G** (General audience)
- **PG** (Parental guidance suggested)
- **PG-13** (Parents strongly cautioned)
- **R** (Restricted)
- **NC-17** (No one 17 and under admitted)
- **X** (Adult only)
- **Blocking Off** (Permits all programs)
- If you set **PG-13**: **G** and **PG** movies will be available, **PG-13, R, NC-17** and **X** will be blocked.

## TV Rating Children - For USA

Prevents children from watching certain children's TV programs, according to the ratings limit set. The children rating does not apply to other TV programs. Unless you block certain TV programs intended for mature audiences in the TV Rating - sub menu, your children can view those programs.



- 1    Select **LOCK**.
- 2  Input the password.
- 3  Select **TV Rating-Children**.
- 4   Select **Age** or **Fantasy Violence**.
- 5   Select block options.
- 6  or  Return to the previous menu.
-  Return to TV viewing.









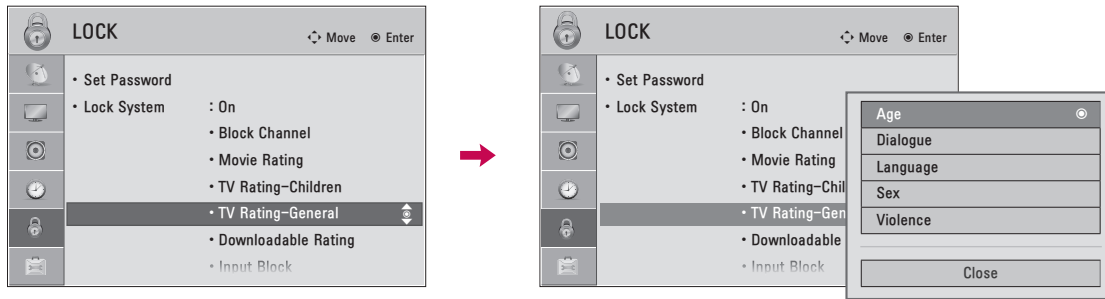



- **Age** (applies to TV-Y, TV-Y7)
- **Fantasy Violence** (applies to TV-Y7)

# PARENTAL CONTROL / RATINGS

## TV Rating General - For USA

Based on the ratings, blocks certain TV programs that you and your family do not want to view.



- 1    Select **LOCK**.
- 2  Input the password.
- 3  Select **TV Rating-General**.
- 4   Select **Age, Dialogue, Language, Sex** or **Violence**.
- 5   Select block options.
- 6  or  Return to the previous menu.
-  Return to TV viewing.

- **Age** (applies to TV-G,TV-PG,TV-14,TV-MA).
- **Dialogue**-sexual dialogue (applies to TV-PG,TV-14).
- **Language**-adult language (applies to TV-PG, TV-14, TV-MA).
- **Sex**-sexual situations (applies to TV-PG, TV-14, TV-MA).
- **Violence** (applies to TV-PG, TV-14, TV-MA).

## TV Rating English - For CANADA

Selecting Canadian English rating system.

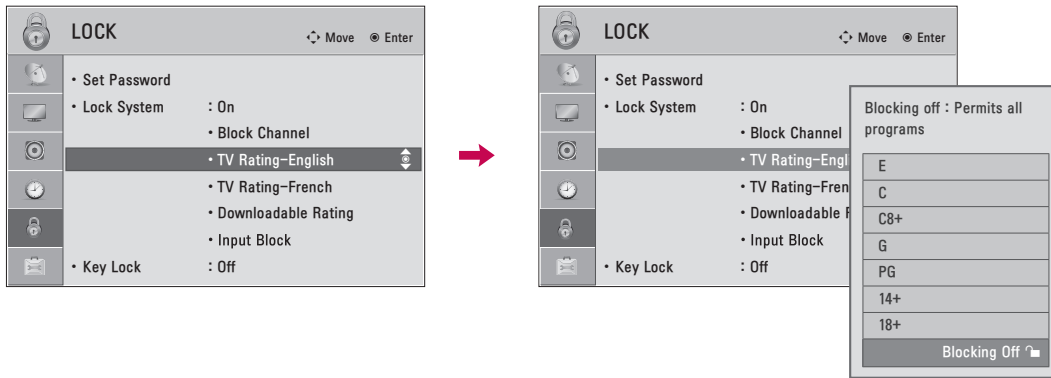

- 1 Select **LOCK**.
- 2 Input the password.
- 3 Select **TV Rating-English**.
- 4 Select **E, C, C8+, G, PG, 14+, 18+, or Blocking Off**.
- 5 or Return to the previous menu.
- Return to TV viewing.

- If TV Rating-English or TV Rating-French is locked, enter the password to unlocked it temporarily.
- **E** (Exempt)
- **C** (Children)
- **C8+** (Children eight years and older)
- **G** (General programming, suitable for all audiences)
- **PG** (Parental Guidance)
- **14+** (Viewers 14 years and older)
- **18+** (Adult programming)
- **Blocking Off** (Permits all programs)

# PARENTAL CONTROL / RATINGS

## TV Rating French - For CANADA

Selecting Canadian French rating system.

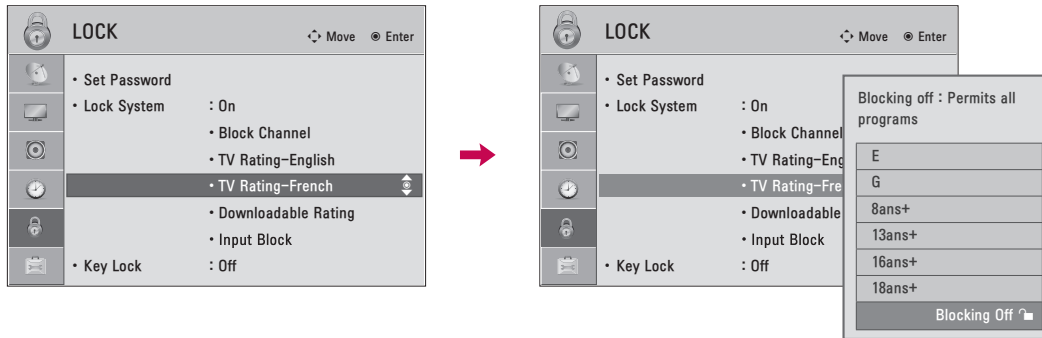

- 1 Select **LOCK**.
- 2 Input the password.
- 3 Select **TV Rating-French**.
- 4 Select **E**, **G**, **8ans+**, **13ans+**, **16ans+**, **18ans+**, or **Blocking Off**.
- 5 or Return to the previous menu.
- Return to TV viewing.

- **E** (Exempt)
- **G** (General)
- **8ans+** (General-Not convenient for little children)
- **13ans+** (Not convenient for children of 13 years and younger)
- **16ans+** (Not convenient for children of 16 years and younger)
- **18ans+** (This programs is only for adults)
- **Blocking Off** (Permits all programs)







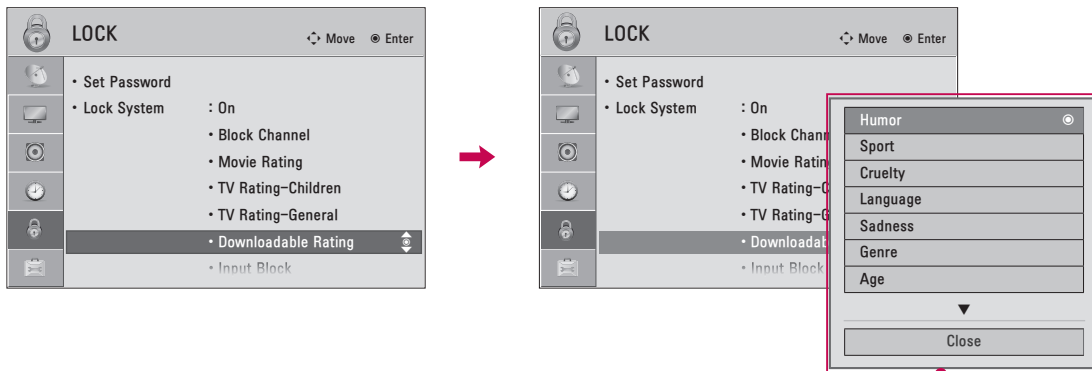





# DOWNLOADABLE RATING

This function is available only for digital channels.

This function operates only when TV has received Region5 Rating data.



■ Based on rating table, your TV's OSD (On Screen Display) may differ slightly from what is shown in this manual.

- 1    Select **LOCK**.
- 2  Input the password.
- 3  Select **Downloadable Rating**.
- 4   Select desired **Downloadable Rating** option.
- 5   Select desired option and block it.
- 6  or  Return to the previous menu.
-  Return to TV viewing.

■ If a Downloadable rating is locked, enter the password to unlock it temporarily.







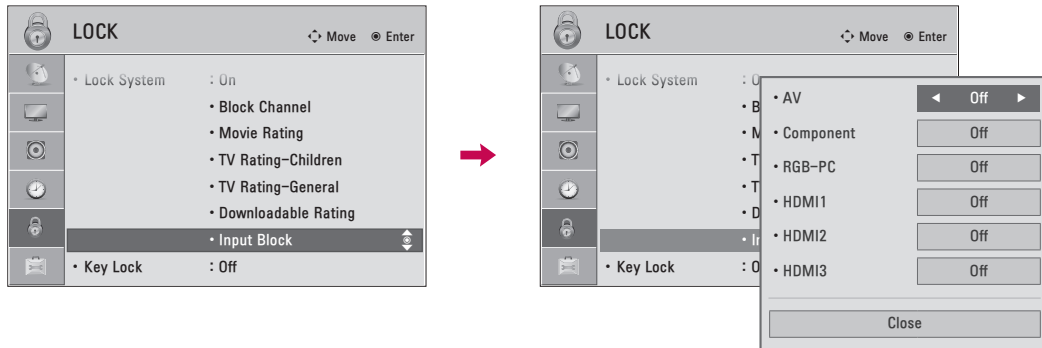

# PARENTAL CONTROL / RATINGS

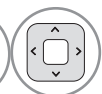
## EXTERNAL INPUT BLOCKING

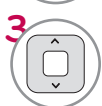
Enables you to block an input.

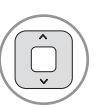

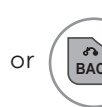
i.e)

-    Select **LOCK**.
-  Input the password.
-  Select **Input Block**.
-   Select input source.
-  Select **On** or **Off**.
-  or  Return to the previous menu.
-  Return to TV viewing.

# KEY LOCK

This feature can be used to prevent unauthorized viewing by locking out the front panel controls, so that it can only be used with the remote control.

This TV is programmed to remember which option it was last set to even if you turn the TV off.

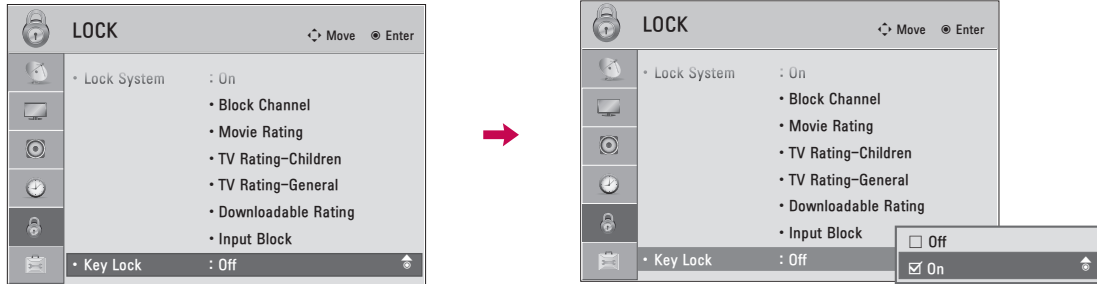

- 1 Select **LOCK**.
- 2 Input the password.
- 3 Select **LOCK**.
- 4 Select **On** or **Off**.
- 5 or Return to the previous menu.
- Return to TV viewing.

- In Key Lock '**On**', if the TV is turned off, press the / **I**, **INPUT**, **CH** ( or ) button on the TV or **POWER**, **INPUT**, **CH** ( ) or **NUMBER** buttons on the remote control.
- With the **Key Lock On**, the display ' **Key Lock**' appears on the screen if any button on the front panel is pressed while viewing the TV.

# APPENDIX

## TROUBLESHOOTING

Abnormal Operation	
The remote control doesn't work	<ul style="list-style-type: none"> <li>Check to see if there is any object between the product and the remote control causing obstruction. Ensure you are pointing the remote control directly at the TV.</li> <li>Ensure that the batteries are installed with correct polarity (+ to +, - to -).</li> <li>Ensure that the correct remote operating mode is set: TV, VCR etc.</li> <li>Install new batteries. <small>*This feature is not available for all models.</small></li> </ul>
TV turns off suddenly	<ul style="list-style-type: none"> <li>Is the sleep timer set?</li> <li>Check the power control settings. Power interrupted.</li> <li>If there is no signal, the TV turns off automatically in 15 minutes.</li> </ul>

Video Problems	
No picture & No sound	<ul style="list-style-type: none"> <li>Check whether the product is turned on.</li> <li>Try another channel. The problem may be with the broadcast.</li> <li>Is the power cord inserted into wall power outlet?</li> <li>Check your antenna direction and/or location.</li> <li>Test the wall power outlet, plug another product's power cord into the outlet where the product's power cord was plugged in.</li> </ul>
Picture appears slowly after switching on	<ul style="list-style-type: none"> <li>This is normal, the image is muted during the product startup process. Please contact your service center, if the picture has not appeared after five minutes.</li> </ul>
No or poor color or poor picture	<ul style="list-style-type: none"> <li>Adjust Color in menu option.</li> <li>Keep a sufficient distance between the product and the VCR.</li> <li>Try another channel. The problem may be with the broadcast.</li> <li>Are the video cables installed properly?</li> <li>Activate any function to restore the brightness of the picture.</li> </ul>
Horizontal/vertical bars or picture shaking	<ul style="list-style-type: none"> <li>Check for local interference such as an electrical appliance or power tool.</li> </ul>
Poor reception on some channels	<ul style="list-style-type: none"> <li>Station or cable product experiencing problems, tune to another station.</li> <li>Station signal is weak, reorient antenna to receive weaker station.</li> <li>Check for sources of possible interference.</li> </ul>
Lines or streaks in pictures	<ul style="list-style-type: none"> <li>Check antenna (Change the direction of the antenna).</li> </ul>
No picture when connecting HDMI	<ul style="list-style-type: none"> <li>If an HDMI cable doesn't support High Speed HDMI, it can cause flickers or no screen display. In this case use the latest cables that support High Speed HDMI.</li> </ul>

Audio Problems	
No output from one of the speakers	<ul style="list-style-type: none"> <li>Adjust Balance in menu option.</li> </ul>
Unusual sound from inside the product	<ul style="list-style-type: none"> <li>A change in ambient humidity or temperature may result in an unusual noise when the product is turned on or off and does not indicate a fault with the product.</li> </ul>
No sound when connecting HDMI/USB	<ul style="list-style-type: none"> <li>Check High Speed HDMI cable.</li> <li>Check USB cable over version 2.0.</li> <li>Use normal MP3 file. <small>*This feature is not available for all models.</small></li> </ul>

PC Mode Problems	
The signal is out of range	<ul style="list-style-type: none"> <li>Adjust resolution, horizontal frequency, or vertical frequency on the PC.</li> <li>Check the input source.</li> </ul>
Vertical bar or stripe on background & Horizontal Noise & Incorrect position	<ul style="list-style-type: none"> <li>Activate the Auto configure feature or adjust size, phase, or H/V position. (Option)</li> </ul>
Screen color is unstable or single color	<ul style="list-style-type: none"> <li>Check the signal cable.</li> <li>Reinstall the PC video card.</li> </ul>
When connecting the HDMI cable to the PC, there is no audio.	<ul style="list-style-type: none"> <li>Check the manual for the video card in the PC to see if it supports HDMI audio and how to set it up properly.</li> </ul>

# APPENDIX

Movie List Problems	
The file does not appear on the Movie List.	<ul style="list-style-type: none"><li>■ Check whether the file extension is supported.</li></ul>
Message is displayed saying "This file is invalid" or the audio is working normally but the video is not working normally.	<ul style="list-style-type: none"><li>■ Check whether the file is playing normally on a PC. (Check whether the file is damaged.)</li><li>■ Check whether the resolution is supported.</li><li>■ Check whether the video/audio codec is supported.</li><li>■ Check whether the frame rate is supported.</li></ul>
Message is displayed saying "Unsupported Audio" or the video is working normally but the audio is not working normally.	<ul style="list-style-type: none"><li>■ Check whether the file is playing normally on a PC. (Check whether the file is damaged.)</li><li>■ Check whether the audio codec is supported.</li><li>■ Check whether the bit rate is supported.</li><li>■ Check whether the sample rate is supported.</li></ul>
Subtitle is not working.	<ul style="list-style-type: none"><li>■ Check whether the file is playing normally on a PC. (Check whether the file is damaged.)</li><li>■ Check whether the video file and subtitle file name are the same.</li><li>■ Check whether the video file and subtitle file are located in the same folder.</li><li>■ Check whether the subtitle file is supported.</li><li>■ Check whether the language is supported. (When you open the subtitle file on a PC, you can check the language of the subtitle file.)</li></ul>

# MAINTENANCE

Early malfunctions can be prevented. Careful and regular cleaning can extend the amount of time you can enjoy your new TV.

Caution: Be sure to turn the power off and unplug the power cord before you begin any cleaning.

## Cleaning the Screen

- 1 Here's a great way to keep the dust off your screen for a while. Wet a soft cloth in a mixture of lukewarm water and a little fabric softener or dish washing detergent. Wring the cloth until it's almost dry, and then use it to wipe the screen.
- 2 Make sure the excess water is off the screen, and then let it air-dry before you turn on your TV.

## Cleaning the Cabinet

- To remove dirt or dust, wipe the cabinet with a soft, dry, lint-free cloth.
- Please be sure not to use a wet cloth.

## Extended Absence

### CAUTION

- ▶ If you expect to leave your TV dormant for a long time (such as a vacation), it's a good idea to unplug the power cord to protect against possible damage from lightning or power surges.

# APPENDIX

## PRODUCT SPECIFICATIONS

MODELS		19LE5300 (19LE5300-UE)	22LE5300 (22LE5300-UE) 22LE5500 (22LE5500-UA)
Dimensions (Width x Height x Depth)	With stand	471.2 mm x 365.9 mm x 155.4 mm (18.5 inch x 14.4 inch x 6.1 inch)	542.9 mm x 407.1 mm x 155.4 mm (21.3 inch x 16.0 inch x 6.1 inch)
	Without stand	471.2 mm x 315.5 mm x 34.4 mm (18.5 inch x 12.4 inch x 1.3 inch)	542.9 mm x 357.6 mm x 34.4 mm (21.3 inch x 14.0 inch x 1.3 inch)
Weight	With stand	3.4 kg (7.4 lbs)	4.2 kg (9.2 lbs)
	Without stand	3.2 kg (7.0 lbs)	3.9 kg (8.5 lbs)

MODELS		26LE5300 (26LE5300-UE) 26LE5500 (26LE5500-UA)
Dimensions (Width x Height x Depth)	With stand	652.0 mm x 480.8 mm x 191.4 mm (25.6 inch x 18.9 inch x 7.5 inch)
	Without stand	652.0 mm x 420.3 mm x 34.4 mm (25.6 inch x 16.5 inch x 1.3 inch)
Weight	With stand	6.1 kg (13.4 lbs)
	Without stand	5.1 kg (11.2 lbs)

Power Requirement	19LE5300: 24V <sup>===</sup> , 1.6A 22LE5300: 24V <sup>===</sup> , 1.7 A 22LE5500: 24V <sup>===</sup> , 1.7 A 26LE5300: 24V <sup>===</sup> , 1.8 A 26LE5500: 24V <sup>===</sup> , 1.8 A	
Adapter (DC Power)	In: AC100-240 V ~ 50/60 Hz Out: DC 24 V, 3.42 A	
Television System	NTSC-M, ATSC, 64 & 256 QAM	
Program Coverage	VHF 2-13, UHF 14-69, CATV 1-135, DTV 2-69, CADTV 1-135	
External Antenna Impedance	75 Ω	
Environment condition	Operating Temperature	0 °C to 40 °C (32 °F to 104 °F)
	Operating Humidity	Less than 80 %
	Storage Temperature	-20 °C to 60 °C (-4 °F to 140 °F)
	Storage Humidity	Less than 85 %

■ The specifications shown above may be changed without prior notice for quality improvement.

MODELS		32LE5300 (32LE5300-UC)	37LE5300 (37LE5300-UC)
Dimensions (Width x Height x Depth)	With stand	784.6 mm x 558.1 mm x 221.0 mm (30.8 inch x 21.9 inch x 8.7 inch)	905.0 mm x 630.0 mm x 270.0 mm (35.6 inch x 24.8 inch x 10.6 inch)
	Without stand	784.6 mm x 499.5 mm x 39.9 mm (30.8 inch x 19.6 inch x 1.5 inch)	905.0 mm x 568.0 mm x 39.9 mm (35.6 inch x 22.3 inch x 1.5 inch)
Weight	With stand	12.4 kg (27.3 lbs)	15.3 kg (33.7 lbs)
	Without stand	10.5 kg (23.1 lbs)	12.8 kg (28.2 lbs)
Current Value		1.3 A	1.4 A

MODELS		42LE5300 (42LE5300-UC) 42LE530C (42LE530C-UC)	47LE5300 (47LE5300-UC) 47LE530C (47LE530C-UC)
Dimensions (Width x Height x Depth)	With stand	1016.0 mm x 692.0 mm x 270.0 mm (40.0 inch x 27.2 inch x 10.6 inch)	1126.6 mm x 757.9 mm x 284.4 mm (44.3 inch x 29.8 inch x 11.1 inch)
	Without stand	1016.0 mm x 630.0 mm x 29.3 mm (40.0 inch x 24.8 inch x 1.1 inch)	1126.6 mm x 692.0 mm x 29.3 mm (44.3 inch x 27.2 inch x 1.1 inch)
Weight	With stand	19.2 kg (42.3 lbs)	22.6 kg (49.8 lbs)
	Without stand	16.7 kg (36.8 lbs)	19.6 kg (43.2 lbs)
Current Value		1.5 A	1.7 A

MODELS		55LE5300 (55LE5300-UC) 55LE530C (55LE530C-UC)
Dimensions (Width x Height x Depth)	With stand	1306.0 mm x 867.0 mm x 345.0 mm (51.4 inch x 34.1 inch x 13.5 inch)
	Without stand	1306.0 mm x 797.0 mm x 30.7 mm (51.4 inch x 31.3 inch x 1.2 inch)
Weight	With stand	34.05 kg (75.0 lbs)
	Without stand	28.8 kg (63.4 lbs)
Current Value		2.0 A

Power Requirement	AC 120 V ~ 50 / 60 Hz	
Television System	NTSC-M, ATSC, 64 & 256 QAM	
Program Coverage	VHF 2-13, UHF 14-69, CATV 1-135, DTV 2-69, CADTV 1-135	
External Antenna Impedance	75 Ω	
Environment condition	Operating Temperature	0 °C to 40 °C (32 °F to 104 °F)
	Operating Humidity	Less than 80 %
	Storage Temperature	-20 °C to 60 °C (-4 °F to 140 °F)
	Storage Humidity	Less than 85 %

■ The specifications shown above may be changed without prior notice for quality improvement.

# APPENDIX

MODELS		42LE7300 (42LE7300-UA)	47LE7300 (47LE7300-UA)
Dimensions (Width x Height x Depth)	With stand	1009.2 mm x 694.5 mm x 286.5 mm (39.7 inch x 27.3 inch x 11.2 inch)	1119.6 mm x 757.1 mm x 286.5 mm (44.0 inch x 29.8 inch x 11.2 inch)
	Without stand	1009.2 mm x 629.7 mm x 29.3 mm (39.7 inch x 24.7 inch x 1.1 inch)	1119.6 mm x 691.3 mm x 29.3 mm (44.0 inch x 27.2 inch x 1.1 inch)
Weight	With stand	25.5 kg (56.2 lbs)	29.7 kg (65.4 lbs)
	Without stand	21.0 kg (46.2 lbs)	25.2 kg (55.5 lbs)
Current Value		1.3 A	1.5 A
MODELS		55LE7300 (55LE7300-UA)	
Dimensions (Width x Height x Depth)	With stand	1305.2 mm x 874.9 mm x 320.2 mm (51.3 inch x 34.4 inch x 12.6 inch)	
	Without stand	1305.2 mm x 799.4 mm x 32.4 mm (51.3 inch x 31.4 inch x 1.2 inch)	
Weight	With stand	44.5 kg (98.1 lbs)	
	Without stand	37.1 kg (81.7 lbs)	
Current Value		1.8 A	
Power requirement		AC 120 V ~ 50 / 60 Hz	
Television System		NTSC-M, ATSC, 64 & 256 QAM	
Program Coverage		VHF 2-13, UHF 14-69, CATV 1-135, DTV 2-69, CADTV 1-135	
External Antenna Impedance		75 Ω	
Environment condition	Operating Temperature	0 °C to 40 °C (32 °F to 104 °F)	
	Operating Humidity	Less than 80 %	
	Storage Temperature	-20 °C to 60 °C (-4 °F to 140 °F)	
	Storage Humidity	Less than 85 %	

■ The specifications shown above may be changed without prior notice for quality improvement.

MODELS		26LD352C (26LD352C-UA)
Dimensions (Width x Height x Depth)	With stand	663.0 mm x 484.0 mm x 206.8 mm (26.1 inch x 19.0 inch x 8.1 inch)
	Without stand	663.0 mm x 423.0 mm x 79.9 mm (26.1 inch x 16.6 inch x 3.1 inch)
Weight	With stand	7.3 kg (16.0 lbs)
	Without stand	6.2 kg (13.6 lbs)
Current Value		1.0 A
Power requirement		AC 100-240 V ~ 50 / 60 Hz
Television System		NTSC-M, ATSC, 64 & 256 QAM
Program Coverage		VHF 2-13, UHF 14-69, CATV 1-135, DTV 2-69, CADTV 1-135
External Antenna Impedance		75 Ω
Environment condition	Operating Temperature	0 °C to 40 °C (32 °F to 104 °F)
	Operating Humidity	Less than 80 %
	Storage Temperature	-20 °C to 60 °C (-4 °F to 140 °F)
	Storage Humidity	Less than 85 %

■ The specifications shown above may be changed without prior notice for quality improvement.

MODEL		32LD420 (32LD420-UA)	
Dimensions (Width x Height x Depth)	With stand	805.0 mm x 583.0 mm x 224.0 mm (31.6 inch x 22.9 inch x 8.8 inch)	
	Without stand	805.0 mm x 531.0 mm x 79.9 mm (31.6 inch x 20.9 inch x 3.1 inch)	
Weight	With stand	10.8 kg (23.8 lbs)	
	Without stand	9.7 kg (21.3 lbs)	
Current Value		1.4 A	
MODELS		42LD420 (42LD420-UA)	47LD420 (47LD420-UA)
Dimensions (Width x Height x Depth)	With stand	1028.0 mm x 715.4 mm x 297.0 mm (40.4 inch x 28.1 inch x 11.6 inch)	1140.6 mm x 784.8 mm x 337.4 mm (44.9 inch x 30.8 inch x 13.2 inch)
	Without stand	1028.0 mm x 658.6 mm x 87.8 mm (40.4 inch x 25.9 inch x 3.4 inch)	1140.6 mm x 722.9 mm x 99.0 mm (44.9 inch x 28.4 inch x 3.8 inch)
Weight	With stand	16.6 kg (36.5 lbs)	21.6 kg (47.6 lbs)
	Without stand	14.8 kg (32.6 lbs)	19.0 kg (41.8 lbs)
Current Value		1.9 A	2.6 A
MODELS		32LD450 (32LD450-UA) 32LD452C (32LD452C-UA) 32LD452B (32LD452B-UA)	37LD450 (37LD450-UA) 37LD450C (37LD450C-UA) 37LD452C (37LD452C-UA)
Dimensions (Width x Height x Depth)	With stand	799.0 mm x 555.0 mm x 207.0 mm (31.4 inch x 21.8 inch x 8.1 inch)	916.0 mm x 625.0 mm x 261.0 mm (36.0 inch x 24.6 inch x 10.2 inch)
	Without stand	799.0 mm x 506.0 mm x 73.5 mm (31.4 inch x 19.9 inch x 2.8 inch)	916.0 mm x 575.0 mm x 77.4 mm (36.0 inch x 22.6 inch x 3.0 inch)
Weight	With stand	9.1 kg (20.0 lbs)	12.5 kg (27.5 lbs)
	Without stand	8.1 kg (17.8 lbs)	10.8 kg (23.8 lbs)
Current Value		1.2 A	1.6 A
MODELS		42LD450 (42LD450-UA) 42LD450C (42LD450C-UA) 42LD451C (42LD451C-UA) 42LD452C (42LD452C-UA) 42LD452B (42LD452B-UA)	47LD450 (47LD450-UA) 47LD450C (47LD450C-UA) 47LD451C (47LD451C-UA) 47LD452C (47LD452C-UA) 47LD452B (47LD452B-UA)
Dimensions (Width x Height x Depth)	With stand	1023.0 mm x 685.0 mm x 261.0 mm (40.2 inch x 26.9 inch x 10.2 inch)	1136.0 mm x 757.0 mm x 270.0 mm (44.7 inch x 29.8 inch x 10.6 inch)
	Without stand	1023.0 mm x 635.0 mm x 76.6 mm (40.2 inch x 25.0 inch x 3.0 inch)	1136.0 mm x 698.0 mm x 76.5 mm (44.7 inch x 27.4 inch x 3.0 inch)
Weight	With stand	15.1 kg (33.2 lbs)	19.5 kg (42.9 lbs)
	Without stand	13.5 kg (29.7 lbs)	17.5 kg (38.5 lbs)
Current Value		1.9 A	2.6 A
Power requirement		AC 100-240 V ~ 50 / 60 Hz	
Television System		NTSC-M, ATSC, 64 & 256 QAM	
Program Coverage		VHF 2-13, UHF 14-69, CATV 1-135, DTV 2-69, CADTV 1-135	
External Antenna Impedance		75 Ω	
Environment condition	Operating Temperature	0 °C to 40 °C (32 °F to 104 °F)	
	Operating Humidity	Less than 80 %	
	Storage Temperature	-20 °C to 60 °C (-4 °F to 140 °F)	
	Storage Humidity	Less than 85 %	

■ The specifications shown above may be changed without prior notice for quality improvement.

# APPENDIX

MODELS		32LD520 (32LD520-UA)	42LD520 (42LD520-UA)
Dimensions (Width x Height x Depth)	With stand	815.0 mm x 585.6 mm x 210.9 mm (32.0 inch x 23.0 inch x 8.3 inch)	1052.2 mm x 720.1 mm x 270.6 mm (41.4 inch x 28.3 inch x 10.6 inch)
	Without stand	815.0 mm x 529.6 mm x 82.0 mm (32.0 inch x 20.8 inch x 3.2 inch)	1052.2 mm x 657.3 mm x 90.8 mm (41.4 inch x 25.8 inch x 3.5 inch)
Weight	With stand	12.6 kg (27.7 lbs)	19.0 kg (41.8 lbs)
	Without stand	11.4 kg (25.1 lbs)	17.2 kg (37.9 lbs)
Current Value		1.5 A	1.9 A
MODELS		47LD520 (47LD520-UA)	55LD520 (55LD520-UA), 55LD520C (55LD520C-UA)
Dimensions (Width x Height x Depth)	With stand	1173.4 mm x 791.4 mm x 319.0 mm (46.1 inch x 31.1 inch x 12.5 inch)	1357.0 mm x 901.0 mm x 423.0 mm (53.4 inch x 35.4 inch x 16.6 inch)
	Without stand	1173.4 mm x 723.4 mm x 100.8 mm (46.1 inch x 28.4 inch x 3.9 inch)	1357.0 mm x 835.4 mm x 109.6 mm (53.4 inch x 32.8 inch x 4.3 inch)
Weight	With stand	23.6 kg (52.0 lbs)	36.4 kg (80.2 lbs)
	Without stand	20.8 kg (45.8 lbs)	32.9 kg (72.5 lbs)
Current Value		2.5 A	3.4 A
MODELS		42LD630 (42LD630-UC)	47LD630 (47LD630-UC)
Dimensions (Width x Height x Depth)	With stand	1024.0 mm x 685.0 mm x 261.0 mm (40.3 inch x 26.9 inch x 10.2 inch)	1137.0 mm x 758.0 mm x 270.0 mm (44.7 inch x 29.8 inch x 10.6 inch)
	Without stand	1024.0 mm x 621.0 mm x 76.8 mm (40.3 inch x 24.4 inch x 3.0 inch)	1137.0 mm x 685.0 mm x 76.8 mm (44.7 inch x 26.9 inch x 3.0 inch)
Weight	With stand	15.5 kg (34.1 lbs)	20.3 kg (44.7 lbs)
	Without stand	13.9 kg (30.6 lbs)	18.3 kg (40.3 lbs)
Current Value		2.1 A	2.5 A
MODELS		55LD630 (55LD630-UC)	
Dimensions (Width x Height x Depth)	With stand	1329.0 mm x 872.0 mm x 330.0 mm (52.3 inch x 34.3 inch x 12.9 inch)	
	Without stand	1329.0 mm x 796.0 mm x 96.5 mm (52.3 inch x 31.3 inch x 3.7 inch)	
Weight	With stand	33.0 kg (72.7 lbs)	
	Without stand	29.8 kg (65.6 lbs)	
Current Value		3.4 A	
Power requirement		AC 100-240 V ~ 50 / 60 Hz	
Television System		NTSC-M, ATSC, 64 & 256 QAM	
Program Coverage		VHF 2-13, UHF 14-69, CATV 1-135, DTV 2-69, CADTV 1-135	
External Antenna Impedance		75 Ω	
Environment condition	Operating Temperature	0 °C to 40 °C (32 °F to 104 °F)	
	Operating Humidity	Less than 80 %	
	Storage Temperature	-20 °C to 60 °C (-4 °F to 140 °F)	
	Storage Humidity	Less than 85 %	

■ The specifications shown above may be changed without prior notice for quality improvement.

# IR CODE

Code (Hexa)	Function	Note	Code (Hexa)	Function	Note
00	CH ^	Remote Control Button	0C	POTAL	Remote Control Button
01	CH v	Remote Control Button	AB	GUIDE	Remote Control Button
02	VOL +	Remote Control Button	B0	▶	Remote Control Button
03	VOL -	Remote Control Button	B1	■	Remote Control Button
06	›	Remote Control Button	BA		Remote Control Button
07	‹	Remote Control Button	D6	TV	Discrete IR Code (TV Input Selection)
08	⏻	Remote Control Button (Power On/Off)	C4	POWER ON	Discrete IR Code (Only Power On)
09	MUTE	Remote Control Button	C5	POWER OFF	Discrete IR Code (Only Power Off)
0B	INPUT	Remote Control Button	5A	AV or AV1	Discrete IR Code (AV1 Input Selection)
0F	TV	Remote Control Button	D0	AV2	Discrete IR Code (AV2 Input Selection)
10-19	Number 0-9	Remote Control Button	BF	COMPONENT	Discrete IR Code (Component Input Selection)
1A	FLASHBK	Remote Control Button	D5	RGB-PC	Discrete IR Code (RGB-PC Input Selection)
1E	FAV/MARK	Remote Control Button	CE	HDMI1	Discrete IR Code (HDMI1 Input Selection)
28	BACK or RETURN	Remote Control Button	CC	HDMI2	Discrete IR Code (HDMI2 Input Selection)
30	AV MODE	Remote Control Button	E9	HDMI3	Discrete IR Code (HDMI3 Input Selection)
40	^	Remote Control Button	DA	HDMI4	Discrete IR Code (HDMI4 Input Selection)
41	v	Remote Control Button	76	Ratio 4:3	Discrete IR Code (Only 4:3 Mode)
43	MENU	Remote Control Button	77	Ratio 16:9	Discrete IR Code (Only 16:9 Mode)
44	ENTER	Remote Control Button	AF	Ratio Zoom	Discrete IR Code (Only Zoom Mode)
45	Q.MENU	Remote Control Button			
4C	- (Dash)/LIST	Remote Control Button			
5B	EXIT	Remote Control Button			
79	RATIO	Remote Control Button			
7E	SIMPLINK	Remote Control Button			
8E	▶▶	Remote Control Button			
8F	◀◀	Remote Control Button			
95	ENERGY SAVING	Remote Control Button			
AA	INFO	Remote Control Button			
61	C3 BLUE	Remote Control Button			
63	C2 YELLOW	Remote Control Button			
71	C0 GREEN	Remote Control Button			
72	C1 RED	Remote Control Button			

For 32/37/42/47LD452C, 32/42/47LD452B

■ Use this feature depending on your models.

# APPENDIX

## EXTERNAL CONTROL THROUGH RS-232C

The RS-232C port allows you connect the RS-232C input jack to an external control device (such as a computer or an A/V control system) to control the TV's functions externally.

- Note: RS-232C on this unit is intended to be used with third party RS-232C control hardware and software.

The instructions below are provided to help with programming software or to test functionality using telenet software.

### RS-232C Setup

i.e)

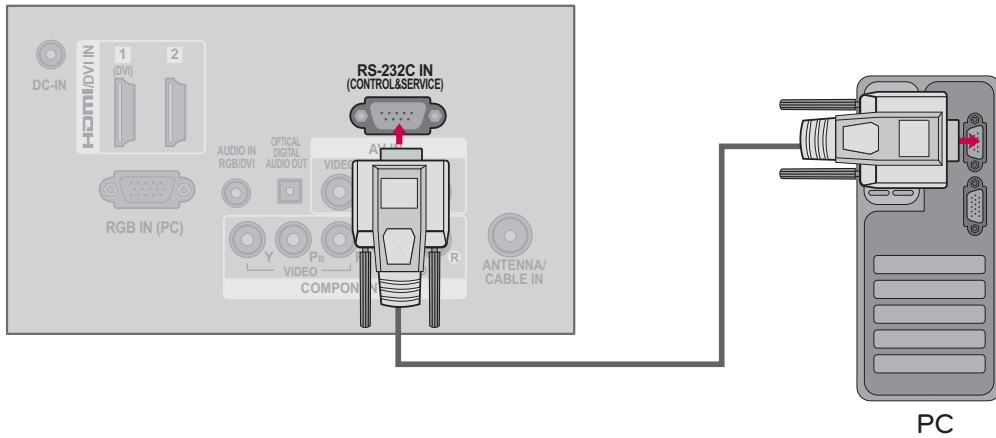

### Type of Connector; D-Sub 9-Pin Male

### Communication Parameters

No.	Pin Name
1	No connection
2	RXD (Receive data)
3	TXD (Transmit data)
4	DTR (DTE side ready)
5	GND
6	DSR (DCE side ready)
7	RTS (Ready to send)
8	CTS (Clear to send)
9	No Connection

- Baud rate : 9600 bps (UART)
- Data length : 8 bits
- Parity : None
- Stop bit : 1 bit
- Communication code : ASCII code
- Use a crossed (reverse) cable.

**NOTE**  
 ▶ This product has command echo back in the RS-232C Command.

# RS-232C Configurations

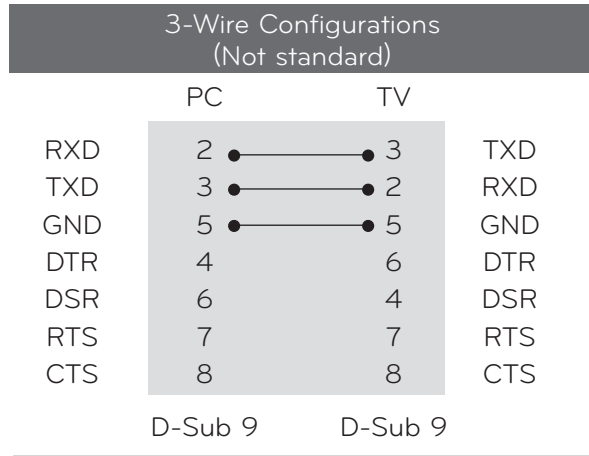
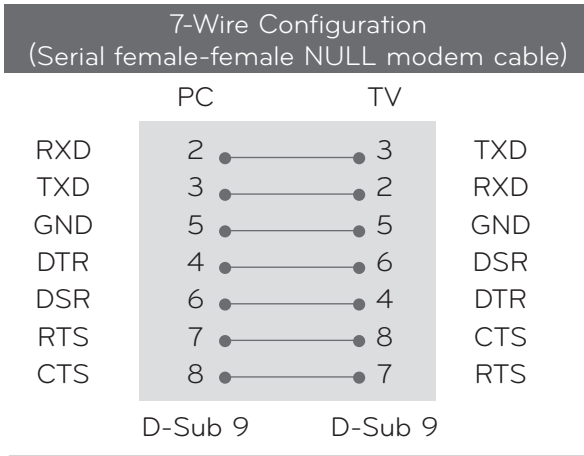

## Set ID

Use this function to specify a TV ID number.  
Refer to 'Real Data Mapping'.

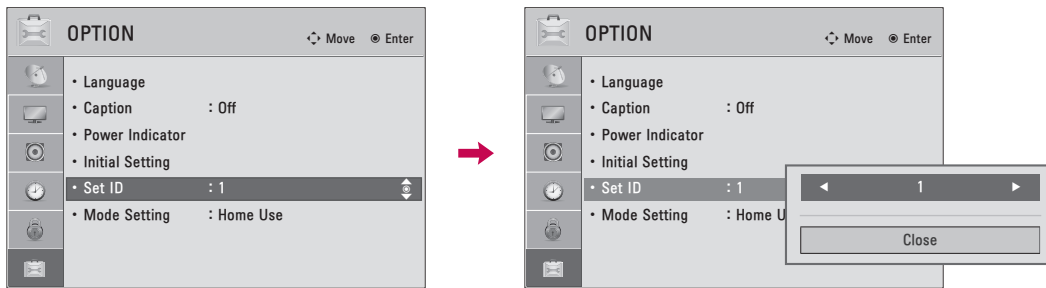

- 1 Select **OPTION**.
- 2 Select **Set ID**.
- 3 Choose the desired TV ID number.  
The adjustment range of Set ID is 1~99.
- 4 or Return to the previous menu.
- Return to TV viewing.

Real data mapping	
0	Step 0
⋮	
A	Step 10 (Set ID 10)
⋮	
F	Step 15 (Set ID 15)
10	Step 16 (Set ID 16)
⋮	
63	Step 99 (Set ID 99)
64	Step 100

# APPENDIX

## Command Reference List

	COMMAND1	COMMAND2	DATA (Hexadecimal)
01. Power	k	a	00 - 01
02. Input Select	x	b	▶ P.155
03. Aspect Ratio	k	c	▶ P.155
04. Screen Mute	k	d	00 - 01
05. Volume Mute	k	e	00 - 01
06. Volume Control	k	f	00 - 64
07. Contrast	k	g	00 - 64
08. Brightness	k	h	00 - 64
09. Color	k	i	00 - 64
10. Tint	k	j	00 - 64
11. Sharpness	k	k	00 - 64
12. OSD Select	k	l	00 - 01
13. Remote Control Lock Mode	k	m	00 - 01
14. Treble	k	r	00 - 64
15. Bass	k	s	00 - 64
16. Balance	k	t	00 - 64
17. Color Temperature	x	u	00 - 64
18. Energy Saving	j	q	▶ P.156
19. Auto Configuration	j	u	▶ P.156
21. Channel Add/Del	m	b	00 - 01
22. Key	m	c	▶ P.157
23. Backlight	m	g	00 - 64

	COMMAND1	COMMAND2	DATA00 (Hexadecimal)	DATA01 (Hexadecimal)		
20. Channel Tuning	m	a	physical program high	major program low		
			DATA02 (Hexadecimal)	DATA03 (Hexadecimal)	DATA04 (Hexadecimal)	DATA05 (Hexadecimal)
			major low	minor high	minor low	attribute

## Transmission / Receiving Protocol

### Transmission

[Command1][Command2][ ][Set ID][ ][Data][Cr]

[Command 1] : First command to control the set. (j, k, m or x)

[Command 2] : Second command to control the set.

[Set ID] : You can adjust the set ID to choose desired TV ID number in Setup menu. Adjustment range is 1-99. When selecting Set ID '0', every connected the TV is controlled. Set ID is indicated as decimal (1-99) on menu and as Hexa decimal (0x0 - 0x63) on transmission /receiving protocol.

[DATA] : To transmit the command data.

Transmit the 'FF' data to read status of command.

[Cr] : Carriage Return

ASCII code '0x0D'

[ ] : ASCII code 'space (0x20)'

\* In this model, TV will not send the status during the standby mode.

### OK Acknowledgement

[Command2][ ][Set ID][ ][OK][Data][x]

The TV transmits ACK (acknowledgement) based on this format when receiving normal data. At this time, if the data is data read mode, it indicates present status data. If the data is data write mode, it returns the data of the PC computer.

\* In this model, TV will not send the status during the standby mode.

\* Data Format

[Command 2] : Use as command.

[Set ID] : Use the small character, if set ID is 10, it will send the '0', 'a'.

[DATA] : Use the small character, if data is 0 x ab, it will send the 'a', 'b'.

[OK] : Use the large character.

### Error Acknowledgement

[Command2][ ][Set ID][ ][NG][Data][x]

The TV transmits ACK (acknowledgement) based on this format when receiving abnormal data from non-viable functions or communication errors.

Data1: Illegal Code

Data2: Not supported function

Data3: Wait more time

\* In this model, TV will not send the status during the standby mode.

\* Data Format

[Command 2] : Use as command.

[Set ID] : Use the small character, if set ID is 10, it will send the '0', 'a'.

[DATA] : Use the small character, if data is 0 x ab, it will send the 'a', 'b'.

[NG] : Use the large character

**01. Power (Command: k a)**

To control Power On/Off of the TV.

Transmission [k][a][ ][Set ID][ ][Data][Cr]

Data 00: Power Off      Data 01: Power On

Acknowledgement [a][ ][Set ID][ ][OK/NG][Data][x]

\* In a like manner, if other functions transmit 'FF' data based on this format, Acknowledgement data feedback presents status about each function.

\* Note: In this model, TV will send the Acknowledge after power on processing completion.

There might be a time delay between command and acknowledge.

**02. Input Select (Command: x b)**

To select input source for TV.

Transmission [x][b][ ][Set ID][ ][Data][Cr]

Data 00: DTV (Antenna)      Data 01: DTV (Cable)

Data 10: Analog (Antenna)      Data 11: Analog (Cable)

Data 20: AV or AV1      Data 21: AV 2

Data 40: Component or Component1

Data 41: Component2

Data 60: RGB-PC      Data 90: HDMI1

Data 91: HDMI2      Data 92: HDMI3

Data 93: HDMI4

Acknowledgement [b][ ][Set ID][ ][OK/NG][Data][x]

\* Use the feature depending on your model.

**03. Aspect Ratio (Command: k c)**

To adjust the screen format.

Transmission [k][c][ ][Set ID][ ][Data][Cr]

Data 01: 4:3      Data 09: Just scan

Data 02: 16:9      Data 10: Cinema Zoom1

Data 04: Zoom      :

Data 06: Set by program      Data 1F: Cinema Zoom16

Acknowledgement [c][ ][Set ID][ ][OK/NG][Data][x]

**04. Screen Mute (Command: k d)**

To select screen mute on/off.

Transmission [k][d][ ][Set ID][ ][Data][Cr]

Data 00: Screen mute off (Picture on), Video-out Mute off

Data 01: Screen mute on (Picture off)

Data 10: Video-out Mute on

Acknowledgement [d][ ][Set ID][ ][OK/NG][Data][x]

\* In case of Video-out Mute on only, TV will display On Screen Display (OSD). But, in case of screen mute on, TV will not display On Screen Display (OSD).

**05. Volume Mute (Command: k e)**

To control volume mute on/off.

You can also adjust mute using the MUTE button on remote control.

Transmission [k][e][ ][Set ID][ ][Data][Cr]

Data 00: Volume mute on (Volume off)

Data 01: Volume mute off (Volume on)

Acknowledgement [e][ ][Set ID][ ][OK/NG][Data][x]

**06. Volume Control (Command: k f)**

To adjust volume.

You can also adjust volume with the volume buttons on remote control.

Transmission [k][f][ ][Set ID][ ][Data][Cr]

Data Min: 00 - Max: 64 (\*transmit by Hexadecimal code)

\*Refer to 'Real data mapping'.

Acknowledgement [f][ ][Set ID][ ][OK/NG][Data][x]

**07. Contrast (Command: k g)**

To adjust screen contrast.

You can also adjust contrast in the PICTURE menu.

Transmission [k][g][ ][Set ID][ ][Data][Cr]

Data Min: 00 - Max: 64 (\*transmit by Hexadecimal code)

\*Refer to 'Real data mapping'.

Acknowledgement [g][ ][Set ID][ ][OK/NG][Data][x]

**08. Brightness (Command: k h)**

To adjust screen brightness.

You can also adjust brightness in the PICTURE menu.

Transmission [k][h][ ][Set ID][ ][Data][Cr]

Data Min: 00 - Max: 64 (\*transmit by Hexadecimal code)

\*Refer to 'Real data mapping'.

Acknowledgement [h][ ][Set ID][ ][OK/NG][Data][x]

**09. Color (Command: k i)**

To adjust screen color.

You can also adjust color in the PICTURE menu.

Transmission [k][i][ ][Set ID][ ][Data][Cr]

Data Min: 00 - Max: 64 (\*transmit by Hexadecimal code)

\*Refer to 'Real data mapping'.

Acknowledgement [i][ ][Set ID][ ][OK/NG][Data][x]

**10. Tint (Command: k j)**

To adjust screen tint.

You can also adjust tint in the PICTURE menu.

Transmission [k][j][ ][Set ID][ ][Data][Cr]

Data Red: 00 - Green: 64 (\*transmit by Hexadecimal code)

\*Refer to 'Real data mapping'.

Acknowledgement [j][ ][Set ID][ ][OK/NG][Data][x]

# APPENDIX

## 11. Sharpness (Command: k k)

To adjust screen sharpness.  
You can also adjust sharpness in the Picture menu.

Transmission [k][k][ ][Set ID][ ][Data][Cr]

Data Min: 00 - Max: 64 (\*transmit by Hexadecimal code)  
\*Refer to 'Real data mapping'.

Acknowledgement [k][ ][Set ID][ ][OK/NG][Data][x]

## 12. OSD Select (Command: k l)

To select OSD (On Screen Display) on/off.

Transmission [k][l][ ][Set ID][ ][Data][Cr]

Data 00: OSD off      Data 01: OSD on

Acknowledgement [l][ ][Set ID][ ][OK/NG][Data][x]

## 13. Remote Control Lock Mode (Command: k m)

To lock the remote control and the front panel controls on the set.

Transmission [k][m][ ][Set ID][ ][Data][Cr]

Data 00: Lock off      Data 01: Lock on

Acknowledgement [m][ ][Set ID][ ][OK/NG][Data][x]

If you're not using the remote control and front panel controls on the TV, use this mode. When main power is on/off, remote control lock is released.

If Key Lock is on in the standby mode, TV will not turn on by POWER button of remote control and on the TV.

## 14. Treble (Command: k r)

To adjust treble.  
You can also adjust treble in the Audio menu.

Transmission [k][r][ ][Set ID][ ][Data][Cr]

Data Min: 00 - Max: 64 (\*transmit by Hexadecimal code)  
\*Refer to 'Real data mapping'.

Acknowledgement [r][ ][Set ID][ ][OK/NG][Data][x]

## 15. Bass (Command: k s)

To adjust bass.  
You can also adjust bass in the Audio menu.

Transmission [k][s][ ][Set ID][ ][Data][Cr]

Data Min: 00 - Max: 64 (\*transmit by Hexadecimal code)  
\*Refer to 'Real data mapping'.

Acknowledgement [s][ ][Set ID][ ][OK/NG][Data][x]

## 16. Balance (Command: k t)

To adjust balance.  
You can also adjust balance in the Audio menu.

Transmission [k][t][ ][Set ID][ ][Data][Cr]

Data Min: 00 - Max: 64 (\*transmit by Hexadecimal code)  
\*Refer to 'Real data mapping'.

Acknowledgement [t][ ][Set ID][ ][OK/NG][Data][x]

## 17. Color Temperature (Command: x u)

To adjust color temperature.  
You can also adjust color temperature in the Picture menu.

Transmission [x][u][ ][Set ID][ ][Data][Cr]

Data Min: 00 - Max: 64 (\*transmit by Hexadecimal code)  
\*Refer to 'Real data mapping'.

Acknowledgement [u][ ][Set ID][ ][OK/NG][Data][x]

## 18. Energy Saving (Command: j q)

To control the energy saving function.

Transmission [ j ][q][ ][Set ID][ ][Data][Cr]

Data 00: Energy saving - off  
01: Energy saving - Minimum  
02: Energy saving - Medium  
03: Energy saving - Maximum  
04: Energy saving - Auto (depending on model)  
05: Energy saving - Screen off

Acknowledgement [q][ ][Set ID][ ][OK/NG][Data][x]

## 19. Auto Configuration (Command: j u)

To adjust picture position and minimize image shaking automatically. Auto configuration only works in RGB-PC mode.

Transmission [ j ][u][ ][Set ID][ ][Data][Cr]

Data 01: To set

Acknowledgement [u][ ][Set ID][ ][OK/NG][Data][x]

## 20. Channel Tuning (Command: m a)

To tune channel to following physical/major/minor number.

Transmission [m][a][ ][Set ID][ ][Data00][ ][Data01][ ][Data02][ ][Data03][ ][Data04][ ][Data05][Cr]

Digital channels have a Physical, Major, and Minor channel number. The Physical number is the actual digital channel number, the Major is the number that the channel should be mapped to, and the Minor is the sub-channel. Since the ATSC tuner automatically maps the channel to the Major number, the Physical number is not required when sending a command.

Data 00: Physical Channel Number  
NTSC air: 02 - 45, NTSC cable: 01, 0E - 7D  
ATSC air: 01 - 45, ATSC cable: 01 - 87

Data 01 & 02: Major Channel Number  
Data 01: High byte      Data 02: Low byte

Two bytes are available for the Major and Minor, normally only the second byte is used.

Data 03 & 04: Minor Channel Number  
Not needed for NTSC.

Data5:	7 Main/Sub Picture	6 Two/One Part Channel	5 Using Physical Channel	4 Reserved	3	2	1	0	Step
	0 Main	0 Two	0 Use	x	0	0	0	0	NTSC Air
	1 Sub	1 One	1 No Use	x	0	0	0	1	NTSC Cable
				x	0	0	1	0	ATSC Air
				x	0	0	1	1	ATSC Cable_std
				x	0	1	0	0	ATSC Cable_hrc
				x	0	1	0	1	ATSC Cable_irc
				x	0	1	1	0	ATSC cable_auto
				x	0	1	1	1	Reserved
				x	x	x	x	x	...
				x	1	1	1	1	Reserved

The table above lists the binary code which must be converted to Hexadecimal before sending. For example: The binary code to tune the sub source to an NTSC cable channel is "1000 0001", which translates to "81" in Hex.

- \* 7th bit : For which source do you want to change the channel.
- \* 6th bit: Use a two part or one part channel. Most cases just use 0 since it's ignored when using NTSC.
- \* 5th bit: Use 0 with NTSC since it can only use the physical channel number. Normally use 1 for ATSC since most times it doesn't matter what the physical number is.
- \* 4th bit: Set to 0.
- \* 3-0 bits: Choose signal type.

\*Tune Command Examples:

1. Tune to the analog (NTSC) cable channel 35.

Data 00 = Physical of 35 = 23  
 Data 01 & 02 = No Major = 00 00  
 Data 03 & 04 = No Minor = 00 00  
 Data 05 = 0000 0001 in binary = 01  
 Total = ma 00 23 00 00 00 00 01

2. Tune to the digital (ATSC) local channel 30-3.

Data 00 = Don't know Physical = 00  
 Data 01 & 02 = Major is 30 = 00 1E  
 Data 03 & 04 = Minor is 3 = 00 03  
 Data 05 = 0010 0010 in binary = 22  
 Total = ma 00 00 00 1E 00 03 22

## 21. Channel Add/Del (Command: m b)

To add and delete the channels.

Transmission [m][b][ ][Set ID][ ][Data][Cr]

Data 00: Channel Delete Data 01: Channel Add

Acknowledgement [b][ ][Set ID][ ][OK/NG][Data][x]

## 22. Key (Command: m c)

To send IR remote control code.

Transmission [m][c][ ][Set ID][ ][Data][Cr]

See page 151.

Acknowledgement [c][ ][Set ID][ ][OK/NG][Data][x]

When TV is in the standby mode, TV will turn on by POWER button of remote control only.

## 23. Backlight (Command: m g)

To adjust screen backlight.

Transmission [m][g][ ][Set ID][ ][Data][Cr]

Data Min:00 ~ Max:64 (\*transmit by Hexadecimal code)

\*Refer to 'Real data mapping'.

Acknowledgement [g][ ][Set ID][ ][OK/NG][Data][x]

# APPENDIX

## OPEN SOURCE LICENSE

### GNU GENERAL PUBLIC LICENSE

Version 2, June 1991

Copyright (C) 1989, 1991 Free Software Foundation, Inc., 51 Franklin Street, Fifth Floor, Boston, MA 02110-1301 USA

Everyone is permitted to copy and distribute verbatim copies of this license document, but changing it is not allowed.

#### Preamble

The licenses for most software are designed to take away your freedom to share and change it. By contrast, the GNU General Public License is intended to guarantee your freedom to share and change free software - to make sure the software is free for all its users. This General Public License applies to most of the Free Software Foundation's software and to any other program whose authors commit to using it. (Some other free software foundation software is covered by the GNU Lesser General Public License instead.) You can apply it to your programs, too.

When we speak of free software, we are referring to freedom, not price. Our General Public Licenses are designed to make sure that you have the freedom to distribute copies of free software (and charge for this service if you wish), that you receive source code or can get it if you want it, that you can change the software or use pieces of it in new free programs; and that you know you can do these things.

To protect your rights, we need to make restrictions that forbid anyone to deny you these rights or to ask you to surrender the rights. These restrictions translate to certain responsibilities for you if you distribute copies of the software, or if you modify it.

For example, if you distribute copies of such a program, whether gratis or for a fee, you must give the recipients all the rights that you have. You must make sure that they, too, receive or can get the source code. And you must show them these terms so they know their rights.

We protect your rights with two steps: (1) copyright the software, and (2) offer you this license which gives you legal permission to copy, distribute and/or modify the software.

Also, for each author's protection and ours, we want to make certain that everyone understands that there is no warranty for this free software. If the software is modified by someone else and passed on, we want its recipients to know that what they have is not the original, so that any problems introduced by others will not reflect on the original authors' reputations.

Finally, any free program is threatened constantly by software patents. We wish to avoid the danger that redistributors of a free program will individually obtain patent licenses, in effect making the program proprietary. To prevent this, we have made it clear that any patent must be

licensed for everyone's free use or not licensed at all.

The precise terms and conditions for copying, distribution and modification follow.

#### GNU GENERAL PUBLIC LICENSE TERMS AND CONDITIONS FOR COPYING, DISTRIBUTION AND MODIFICATION

0. This license applies to any program or other work which contains a notice placed by the copyright holder saying it may be distributed under the terms of this General Public License. The "Program", below, refers to any such program or work, and a "work based on the Program" means either the Program or any derivative work under copyright law: that is to say, a work containing the Program or a portion of it, either verbatim or with modifications and/or translated into another language. (Hereinafter, translation is included without limitation in the term "modification".) Each licensee is addressed as "you".

Activities other than copying, distribution and modification are not covered by this license; they are outside its scope. The act of running the Program is not restricted, and the output from the program is covered only if its contents constitute a work based on the program (independent of having been made by running the program). Whether that is true depends on what the program does.

1. You may copy and distribute verbatim copies of the program's source code as you receive it, in any medium, provided that you conspicuously and appropriately publish on each copy an appropriate copyright notice and disclaimer of warranty; keep intact all the notices that refer to this license and to the absence of any warranty; and give any other recipients of the program a copy of this license along with the Program.

You may charge a fee for the physical act of transferring a copy, and you may at your option offer warranty protection in exchange for a fee.

2. You may modify your copy or copies of the program or any portion of it, thus forming a work based on the Program, and copy and distribute such modifications or work under the terms of section 1 above, provided that you also meet all of these conditions:

a) You must cause the modified files to carry prominent notices stating that you changed the files and the date of any change.

- b) You must cause any work that you distribute or publish, that in whole or in part contains or is derived from the Program or any part thereof, to be licensed as a whole at no charge to all third parties under the terms of this license.
- c) If the modified program normally reads commands interactively when run, you must cause it, when started running for such interactive use in the most ordinary way, to print or display an announcement including an appropriate copyright notice and a notice that there is no warranty (or else, saying that you provide a warranty) and that users may redistribute the program under these conditions, and telling the user how to view a copy of this license. (Exception: if the Program itself is interactive but does not normally print such an announcement, your work based on the Program is not required to print an announcement.)

These requirements apply to the modified work as a whole. If identifiable sections of that work are not derived from the Program, and can be reasonably considered independent and separate works in themselves, then this license, and its terms, do not apply to those sections when you distribute them as separate works. But when you distribute the same sections as part of a whole which is a work based on the Program, the distribution of the whole must be on the terms of this license, whose permissions for other licensees extend to the entire whole, and thus to each and every part regardless of who wrote it.

Thus, it is not the intent of this section to claim rights or contest your rights to work written entirely by you; rather, the intent is to exercise the right to control the distribution of derivative or collective works based on the program.

In addition, mere aggregation of another work not based on the program with the Program (or with a work based on the program) on a volume of a storage or distribution medium does not bring the other work under the scope of this license.

- 3. You may copy and distribute the program (or a work based on it, under section 2) in object code or executable form under the terms of sections 1 and 2 above provided that you also do one of the following:
  - a) Accompany it with the complete corresponding machine-readable source code, which must be distributed under the terms of sections 1 and 2 above on a medium customarily used for software interchange; or,
  - b) Accompany it with a written offer, valid for at least three years, to give any third party, for a charge no more than your cost of physically performing source distribution, a complete machine-readable copy of the corresponding source code, to be distributed under the terms of sections 1 and 2 above on a medium customarily used for software interchange; or,

- c) Accompany it with the information you received as to the offer to distribute corresponding source code. (This alternative is allowed only for noncommercial distribution and only if you received the program in object code or executable form with such an offer, in accord with Subsection b above.)

The source code for a work means the preferred form of the work for making modifications to it. For an executable work, complete source code means all the source code for all modules it contains, plus any associated interface definition files, plus the scripts used to control compilation and installation of the executable. However, as a special exception, the source code distributed need not include anything that is normally distributed (in either source or binary form) with the major components (compiler, kernel, and so on) of the operating system on which the executable runs, unless that component itself accompanies the executable.

If distribution of executable or object code is made by offering access to copy from a designated place, then offering equivalent access to copy the source code from the same place counts as distribution of the source code, even though third parties are not compelled to copy the source along with the object code.

- 4. You may not copy, modify, sublicense, or distribute the Program except as expressly provided under this license. Any attempt otherwise to copy, modify, sublicense or distribute the Program is void, and will automatically terminate your rights under this license. However, parties who have received copies, or rights, from you under this license will not have their licenses terminated so long as such parties remain in full compliance.
- 5. You are not required to accept this license, since you have not signed it. However, nothing else grants you permission to modify or distribute the Program or its derivative works. These actions are prohibited by law if you do not accept this license. Therefore, by modifying or distributing the program (or any work based on the program), you indicate your acceptance of this license to do so, and all its terms and conditions for copying, distributing or modifying the program or works based on it.
- 6. Each time you redistribute the program (or any work based on the Program), the recipient automatically receives a license from the original licensor to copy, distribute or modify the Program subject to these terms and conditions. You may not impose any further restrictions on the recipients' exercise of the rights granted herein. You are not responsible for enforcing compliance by third parties to this license.

# APPENDIX

7. If, as a consequence of a court judgment or allegation of patent infringement or for any other reason (not limited to patent issues), conditions are imposed on you (whether by court order, agreement or otherwise) that contradict the conditions of this license, they do not excuse you from the conditions of this license. If you cannot distribute so as to satisfy simultaneously your obligations under this license and any other pertinent obligations, then as a consequence you may not distribute the program at all. For example, if a patent license would not permit royalty-free redistribution of the program by all those who receive copies directly or indirectly through you, then the only way you could satisfy both it and this license would be to refrain entirely from distribution of the program.

If any portion of this section is held invalid or unenforceable under any particular circumstance, the balance of the section is intended to apply and the section as a whole is intended to apply in other circumstances.

It is not the purpose of this section to induce you to infringe any patents or other property right claims or to contest validity of any such claims; this section has the sole purpose of protecting the integrity of the free software distribution system, which is implemented by public license practices. Many people have made generous contributions to the wide range of software distributed through that system in reliance on consistent application of that system; it is up to the author/donor to decide if he or she is willing to distribute software through any other system and a licensee cannot impose that choice.

This section is intended to make thoroughly clear what is believed to be a consequence of the rest of this license.

8. If the distribution and/or use of the program is restricted in certain countries either by patents or by copyrighted interfaces, the original copyright holder who places the program under this license may add an explicit geographical distribution limitation excluding those countries, so that distribution is permitted only in or among countries not thus excluded. In such case, this license incorporates the limitation as if written in the body of this license.
9. The Free Software Foundation may publish revised and/or new versions of the General Public License from time to time. Such new versions will be similar in spirit to the present version, but may differ in detail to address new problems or concerns.

Each version is given a distinguishing version number. If

the program specifies a version number of this license which applies to it and "any later version", you have the option of following the terms and conditions either of that version or of any later version published by the Free Software Foundation. If the program does not specify a version number of this license, you may choose any version ever published by the Free Software Foundation.

10. If you wish to incorporate parts of the program into other free programs whose distribution conditions are different, write to the author to ask for permission. For software which is copyrighted by the Free Software Foundation, write to the Free Software Foundation; we sometimes make exceptions for this. Our decision will be guided by the two goals of preserving the free status of all derivatives of our free software and of promoting the sharing and reuse of software generally.

## NO WARRANTY

11. BECAUSE THE PROGRAM IS LICENSED FREE OF CHARGE, THERE IS NO WARRANTY FOR THE PROGRAM, TO THE EXTENT PERMITTED BY APPLICABLE LAW. EXCEPT WHEN OTHERWISE STATED IN WRITING THE COPYRIGHT HOLDERS AND/OR OTHER PARTIES PROVIDE THE PROGRAM "AS IS" WITHOUT WARRANTY OF ANY KIND, EITHER EXPRESSED OR IMPLIED, INCLUDING, BUT NOT LIMITED TO, THE IMPLIED WARRANTIES OF MERCHANTABILITY AND FITNESS FOR A PARTICULAR PURPOSE. THE ENTIRE RISK AS TO THE QUALITY AND PERFORMANCE OF THE PROGRAM IS WITH YOU. SHOULD THE PROGRAM PROVE DEFECTIVE, YOU ASSUME THE COST OF ALL NECESSARY SERVICING, REPAIR OR CORRECTION.
12. IN NO EVENT UNLESS REQUIRED BY APPLICABLE LAW OR AGREED TO IN WRITING WILL ANY COPYRIGHT HOLDER, OR ANY OTHER PARTY WHO MAY MODIFY AND/OR REDISTRIBUTE THE PROGRAM AS PERMITTED ABOVE, BE LIABLE TO YOU FOR DAMAGES, INCLUDING ANY GENERAL, SPECIAL, INCIDENTAL OR CONSEQUENTIAL DAMAGES ARISING OUT OF THE USE OR INABILITY TO USE THE PROGRAM (INCLUDING BUT NOT LIMITED TO LOSS OF DATA OR DATA BEING RENDERED INACCURATE OR LOSSES SUSTAINED BY YOU OR THIRD PARTIES OR A FAILURE OF THE PROGRAM TO OPERATE WITH ANY OTHER PROGRAMS), EVEN IF SUCH HOLDER OR OTHER PARTY HAS BEEN ADVISED OF THE POSSIBILITY OF SUCH DAMAGES.

## END OF TERMS AND CONDITIONS

### How to apply these terms to your new programs

If you develop a new program, and you want it to be of the greatest possible use to the public, the best way to achieve this is to make it free software which everyone can redistribute and change under these terms.

To do so, attach the following notices to the program. It is safest to attach them to the start of each source file to most effectively convey the exclusion of warranty; and each file should have at least the "copyright" line and a pointer to where the full notice is found.

one line to give the program's name and a brief idea of what it does.

Copyright (C) <year> <name of author>

This program is free software; you can redistribute it and/or modify it under the terms of the GNU General Public License as published by the Free Software Foundation; either version 2 of the license, or (at your option) any later version.

This program is distributed in the hope that it will be useful, but WITHOUT ANY WARRANTY; without even the implied warranty of MERCHANTABILITY or FITNESS FOR A PARTICULAR PURPOSE. See the GNU General Public License for more details.

You should have received a copy of the GNU General Public License along with this program; if not, write to the Free Software Foundation, Inc., 51 Franklin Street, Fifth Floor, Boston, MA 02110-1301 USA.

Also add information on how to contact you by electronic and paper mail.

If the program is interactive, make it output a short notice like this when it starts in an interactive mode:

Gnomovision version 69, Copyright (C) year name of author  
Gnomovision comes with ABSOLUTELY NO WARRANTY;  
for details type 'show w'. This is free software, and you are  
welcome to redistribute it under certain conditions; type  
'show c' for details.

The hypothetical commands 'show w' and 'show c' should show the appropriate parts of the General Public License. Of course, the commands you use may be called something other than 'show w' and 'show c'; they could even be mouse-clicks or menu items-whatever suits your program.

You should also get your employer (if you work as a programmer) or your school, if any, to sign a "copyright disclaimer" for the program, if necessary. Here is a sample; alter the names:

Yoyodyne, Inc., hereby disclaims all copyright interest in the program 'Gnomovision' (which makes passes at compilers) written by James Hacker.

signature of Ty Coon, 1 April 1989  
Ty Coon, President of Vice

This General Public License does not permit incorporating your program into proprietary programs. If your program is a subroutine library, you may consider it more useful to permit linking proprietary applications with the library. If this is what you want to do, use the GNU Lesser General Public License instead of this license.

## GNU LESSER GENERAL PUBLIC LICENSE

Version 2.1, February 1999

Copyright (C) 1991, 1999 Free Software Foundation, Inc. 51 Franklin Street, Fifth Floor, Boston, MA 02110-1301 USA Everyone is permitted to copy and distribute verbatim copies of this license document, but changing it is not allowed.

[This is the first released version of the Lesser GPL. It also counts as the successor of the GNU Library Public License, version 2, hence the version number 2.1.]

### Preamble

The licenses for most software are designed to take away your freedom to share and change it. By contrast, the GNU General Public Licenses are intended to guarantee your freedom to share and change free software - to make sure the software is free for all its users.

This license, the Lesser General Public License, applies to some specially designated software packages - typically libraries - of the Free Software Foundation and other authors who decide to use it. You can use it too, but we suggest you first think carefully about whether this license or the ordinary General Public License is the better strategy to use in any particular case, based on the explanations below.

When we speak of free software, we are referring to freedom of use, not price. Our General Public Licenses are designed to make sure that you have the freedom to distribute copies of free software (and charge for this service if you wish); that you receive source code or can get it if you want it; that you can change the software and use pieces of it in new free programs; and that you are informed that you can do these things.

To protect your rights, we need to make restrictions that forbid distributors to deny you these rights or to ask you to surrender these rights. These restrictions translate to certain responsibilities for you if you distribute copies of the library or if you modify it.

For example, if you distribute copies of the library, whether gratis or for a fee, you must give the recipients all the rights that we gave you. You must make sure that they, too, receive or can get the source code. If you link other code with the library, you must provide complete object files to the recipients, so that they can relink them with the library after making changes to the library and recompiling it. And you must show them these terms so they know their rights.

We protect your rights with a two-step method: (1) we copyright the library, and (2) we offer you this license, which gives you legal permission to copy, distribute and/or modify the library.

To protect each distributor, we want to make it very clear

that there is no warranty for the free library. Also, if the library is modified by someone else and passed on, the recipients should know that what they have is not the original version, so that the original author's reputation will not be affected by problems that might be introduced by others.

Finally, software patents pose a constant threat to the existence of any free program. We wish to make sure that a company cannot effectively restrict the users of a free program by obtaining a restrictive license from a patent holder. Therefore, we insist that any patent license obtained for a version of the library must be consistent with the full freedom of use specified in this license.

Most GNU software, including some libraries, is covered by the ordinary GNU General Public License. This license, the GNU Lesser General Public License, applies to certain designated libraries, and is quite different from the ordinary General Public License. We use this license for certain libraries in order to permit linking those libraries into non-free programs.

When a program is linked with a library, whether statically or using a shared library, the combination of the two is legally speaking a combined work, a derivative of the original library. The ordinary General Public License therefore permits such linking only if the entire combination fits its criteria of freedom. The Lesser General Public License permits more lax criteria for linking other code with the library.

We call this license the "Lesser" General Public License because it does Less to protect the user's freedom than the ordinary General Public License. It also provides other free software developers Less of an advantage over competing non-free programs. These disadvantages are the reason we use the ordinary General Public License for many libraries. However, the Lesser license provides advantages in certain special circumstances.

For example, on rare occasions, there may be a special need to encourage the widest possible use of a certain library, so that it becomes a de-facto standard. To achieve this, non-free programs must be allowed to use the library. A more frequent case is that a free library does the same job as widely used non-free libraries. In this case, there is little to gain by limiting the free library to free software only, so we use the Lesser General Public License.

In other cases, permission to use a particular library in non-free programs enables a greater number of people to use a large body of free software. For example, permission to use the GNU C Library in non-free programs enables many more people to use the whole GNU operating system, as well as its variant, the GNU/Linux operating system.

Although the Lesser General Public License is less protective of the users' freedom, it does ensure that the user of a program that is linked with the Library has the freedom and the wherewithal to run that program using a modified version of the Library.

The precise terms and conditions for copying, distribution and modification follow. Pay close attention to the difference between a "work based on the library" and a "work that uses the library". The former contains code derived from the library, whereas the latter must be combined with the library in order to run.

#### GNU LESSER GENERAL PUBLIC LICENSE TERMS AND CONDITIONS FOR COPYING, DISTRIBUTION AND MODIFICATION

0. This license agreement applies to any software library or other program which contains a notice placed by the copyright holder or other authorized party saying it may be distributed under the terms of this Lesser General Public License (also called "this license"). Each license is addressed as "you".

A "library" means a collection of software functions and/or data prepared so as to be conveniently linked with application programs (which use some of those functions and data) to form executables.

The "Library", below, refers to any such software library or work which has been distributed under these terms. A "work based on the Library" means either the Library or any derivative work under copyright law: that is to say, a work containing the library or a portion of it, either verbatim or with modifications and/or translated straightforwardly into another language. (Hereinafter, translation is included without limitation in the term "modification".)

"Source code" for a work means the preferred form of the work for making modifications to it. For a library, complete source code means all the source code for all modules it contains, plus any associated interface definition files, plus the scripts used to control compilation and installation of the library.

Activities other than copying, distribution and modification are not covered by this license; they are outside its scope. The act of running a program using the Library is not restricted, and output from such a program is covered only if its contents constitute a work based on the library (independent of the use of the Library in a tool for writing it). Whether that is true depends on what the library does and what the program that uses the library does.

1. You may copy and distribute verbatim copies of the library's complete source code as you receive it, in any medium, provided that you conspicuously and appropriately publish on each copy an appropriate copyright notice and disclaimer of warranty; keep intact all the

notices that refer to this license and to the absence of any warranty; and distribute a copy of this license along with the Library.

You may charge a fee for the physical act of transferring a copy, and you may at your option offer warranty protection in exchange for a fee.

2. You may modify your copy or copies of the Library or any portion of it, thus forming a work based on the Library, and copy and distribute such modifications or work under the terms of section 1 above, provided that you also meet all of these conditions:
- The modified work must itself be a software library.
  - You must cause the files modified to carry prominent notices stating that you changed the files and the date of any change.
  - You must cause the whole of the work to be licensed at no charge to all third parties under the terms of this license.
  - If a facility in the modified Library refers to a function or a table of data to be supplied by an application program that uses the facility, other than as an argument passed when the facility is invoked, then you must make a good faith effort to ensure that, in the event an application does not supply such function or table, the facility still operates, and performs whatever part of its purpose remains meaningful.

(For example, a function in a library to compute square roots has a purpose that is entirely well-defined independent of the application. Therefore, Subsection 2d requires that any application-supplied function or table used by this function must be optional: if the application does not supply it, the square root function must still compute square roots.)

These requirements apply to the modified work as a whole. If identifiable sections of that work are not derived from the library, and can be reasonably considered independent and separate works in themselves, then this license, and its terms, do not apply to those sections when you distribute them as separate works. But when you distribute the same sections as part of a whole which is a work based on the library, the distribution of the whole must be on the terms of this license, whose permissions for other licenses extend to the entire whole, and thus to each and every part regardless of who wrote it.

Thus, it is not the intent of this section to claim rights or contest your rights to work written entirely by you; rather, the intent is to exercise the right to control the distribution of derivative or collective works based on the library.

In addition, mere aggregation of another work not based on the library with the library (or with a work based on the library) on a volume of a storage or distribution medium does not bring the other work under the scope of this license.

# APPENDIX

3. You may opt to apply the terms of the ordinary GNU General Public License instead of this License to a given copy of the Library. To do this, you must alter all the notices that refer to this License, so that they refer to the ordinary GNU General Public License, version 2, instead of to this License. (If a newer version than version 2 of the ordinary GNU General Public License has appeared, then you can specify that version instead if you wish.) Do not make any other change in these notices. Once this change is made in a given copy, it is irreversible for that copy, so the ordinary GNU General Public License applies to all subsequent copies and derivative works made from that copy. This option is useful when you wish to copy part of the code of the library into a program that is not a library.

4. You may copy and distribute the library (or a portion or derivative of it, under Section 2) in object code or executable form under the terms of Sections 1 and 2 above provided that you accompany it with the complete corresponding machine-readable source code, which must be distributed under the terms of sections 1 and 2 above on a medium customarily used for software interchange.

If distribution of object code is made by offering access to copy from a designated place, then offering equivalent access to copy the source code from the same place satisfies the requirement to distribute the source code, even though third parties are not compelled to copy the source along with the object code.

5. A program that contains no derivative of any portion of the Library, but is designed to work with the Library by being compiled or linked with it, is called a "work that uses the Library". Such a work, in isolation, is not a derivative work of the Library, and therefore falls outside the scope of this license.

However, linking a "work that uses the library" with the Library creates an executable that is a derivative of the Library (because it contains portions of the library), rather than a "work that uses the library". The executable is therefore covered by this license. Section 6 states terms for distribution of such executable.

When a "work that uses the library" uses material from a header file that is part of the library, the object code for the work may be a derivative work of the library even though the source code is not.

Whether this is true is especially significant if the work can be linked without the library, or if the work is itself a library. The threshold for this to be true is not precisely defined by law.

If such an object file uses only numerical parameters, data structure layouts and accessories, and small macros and small inline functions (ten lines or less in length), then the use of the object file is unrestricted, regardless of whether it is legally a derivative work. (Executable containing this object code plus portions of

the library will still fall under Section 6.)

Otherwise, if the work is a derivative of the library, you may distribute the object code for the work under the terms of Section 6. Any executable containing that work also fall under Section 6, whether or not they are linked directly with the library itself.

6. As an exception to the sections above, you may also combine or link a "work that uses the library" with the library to produce a work containing portions of the library, and distribute that work under terms of your choice, provided that the terms permit modification of the work for the customer's own use and reverse engineering for debugging such modifications.

You must give prominent notice with each copy of the work that the library is used in it and that the Library and its use are covered by this license. You must supply a copy of this license. If the work during execution displays copyright notices, you must include the copyright notice for the library among them, as well as a reference directing the user to the copy of this license. Also, you must do one of these things:

- a) Accompany the work with the complete corresponding machine-readable source code for the library including whatever changes were used in the work (which must be distributed under Sections 1 and 2 above); and, if the work is an executable linked with the Library, with the complete machine-readable "work that uses the Library", as object code and/or source code, so that the user can modify the library and then relink to produce a modified executable containing the modified library. (It is understood that the user who changes the contents of definitions files in the library will not necessarily be able to recompile the application to use the modified definitions.)
- b) Use a suitable shared library mechanism for linking with the library. A suitable mechanism is one that (1) uses at run time a copy of the library already present on the user's computer system, rather than copying library functions into the executable, and (2) will operate properly with a modified version of the library, if the user installs one, as long as the modified version is interface-compatible with the version that the work was made with.
- c) Accompany the work with a written offer, valid for at least three years, to give the same user the materials specified in Subsection 6, above, for a charge no more than the cost of performing this distribution.
- d) If distribution of the work is made by offering access to copy from a designated place, offer equivalent access to copy the above specified materials from the same place.
- e) Verify that the user has already received a copy of these materials or that you have already sent this user a copy.

For an executable, the required form of the "work that uses the library" must include any data and utility programs needed for reproducing the executable from it. However, as a special exception, the materials to be distributed need not include anything that is normally distributed (in either source or binary form) with the major components (compiler, kernel, and so on) of the operating system on which the executable runs, unless that component itself accompanies the executable.

It may happen that this requirement contradicts the license restrictions of other proprietary libraries that do not normally accompany the operating system. Such a contradiction means you cannot use both them and the library together in an executable that you distribute.

7. You may place library facilities that are a work based on the library side-by-side in a single library together with other library facilities not covered by this license, and distribute such a combined library, provided that the separate distribution of the work based on the Library and of the other library facilities is otherwise permitted, and provided that you do these two things:
  - a) Accompany the combined library with a copy of the same work based on the Library, uncombined with any other library facilities. This must be distributed under the terms of the sections above.
  - b) Give prominent notice with the combined library of the fact that part of it is a work based on the library, and explaining where to find the accompanying uncombined form of the same work.
8. You may not copy, modify, sublicense, link with, or distribute the library except as expressly provided under this license. Any attempt otherwise to copy, modify, sublicense, link with, or distribute the library is void, and will automatically terminate your rights under this license. However, parties who have received copies, or rights, from you under this license will not have their licenses terminated so long as such parties remain in full compliance.
9. You are not required to accept this license, since you have not signed it. However, nothing else grants you permission to modify or distribute the library or its derivative works. These actions are prohibited by law if you do not accept this license. Therefore, by modifying or distributing the library (or any work based on the library), you indicate your acceptance of this license to do so, and all its terms and conditions for copying, distributing or modifying the library or works based on it.
10. Each time you redistribute the library (or any work based on the Library), the recipient automatically receives a license from the original licensor to copy, distribute, link with or modify the library subject to these terms and conditions. You may not impose any further restrictions on the recipients' exercise of the rights granted herein.

You are not responsible for enforcing compliance by third parties with this license.

11. If, as a consequence of a court judgment or allegation of patent infringement or for any other reason (not limited to patent issues), conditions are imposed on you (whether by court order, agreement or otherwise) that contradict the conditions of this license, they do not excuse you from the conditions of this license. If you cannot distribute so as to satisfy simultaneously your obligations under this license and any other pertinent obligations, then as a consequence you may not distribute the library at all. For example, if a patent license would not permit royalty-free redistribution of the library by all those who receive copies directly or indirectly through you, then the only way you could satisfy both it and this license would be to refrain entirely from distribution of the library.

If any portion of this section is held invalid or unenforceable under any particular circumstance, the balance of the section is intended to apply, and the section as a whole is intended to apply in other circumstances.

It is not the purpose of this section to induce you to infringe any patents or other property right claims or to contest validity of any such claims; this section has the sole purpose of protecting the integrity of the free software distribution system which is implemented by public license practices. Many people have made generous contributions to the wide range of software distributed through that system in reliance on consistent application of that system; it is up to the author/donor to decide if he or she is willing to distribute software through any other system and a license cannot impose that choice.

This section is intended to make thoroughly clear what is believed to be a consequence of the rest of this license.

12. If the distribution and/or use of the library is restricted in certain countries either by patents or by copyrighted interfaces, the original copyright holder who places the library under this license may add an explicit geographical distribution limitation excluding those countries, so that distribution is permitted only in or among countries not thus excluded. In such case, this license incorporates the limitation as if written in the body of this license.
13. The Free Software Foundation may publish revised and/or new versions of the Lesser General Public License from time to time. Such new versions will be similar in spirit to the present version, but may differ in detail to address new problems or concerns. Each version is given a distinguishing version number. If the library specifies a version number of this license which applies to it and "any later version", you have the option of following the terms and conditions either of that version or of any later version published by the Free Software Foundation.

# APPENDIX

If the library does not specify a license version number, you may choose any version ever published by the Free Software Foundation.

14. If you wish to incorporate parts of the library into other free programs whose distribution conditions are incompatible with these, write to the author to ask for permission. For software which is copyrighted by the Free Software Foundation, write to the Free Software Foundation; we sometimes make exceptions for this. Our decision will be guided by the two goals of preserving the free status of all derivatives of our free software and of promoting the sharing and reuse of software generally.

## NO WARRANTY

15. BECAUSE THE LIBRARY IS LICENSED FREE OF CHARGE, THERE IS NO WARRANTY FOR THE LIBRARY, TO THE EXTENT PERMITTED BY APPLICABLE LAW. EXCEPT WHEN OTHERWISE STATED IN WRITING THE COPYRIGHT HOLDERS AND/OR OTHER PARTIES PROVIDE THE LIBRARY "AS IS" WITHOUT WARRANTY OF ANY KIND, EITHER EXPRESSED OR IMPLIED, INCLUDING, BUT NOT LIMITED TO, THE IMPLIED WARRANTIES OF MERCHANTABILITY AND FITNESS FOR A PARTICULAR PURPOSE. THE ENTIRE RISK AS TO THE QUALITY AND PERFORMANCE OF THE LIBRARY IS WITH YOU. SHOULD THE LIBRARY PROVE DEFECTIVE, YOU ASSUME THE COST OF ALL NECESSARY SERVICING, REPAIR OR CORRECTION.

16. IN NO EVENT UNLESS REQUIRED BY APPLICABLE LAW OR AGREED TO IN WRITING WILL ANY COPYRIGHT HOLDER, OR ANY OTHER PARTY WHO MAY MODIFY AND/OR REDISTRIBUTE THE LIBRARY AS PERMITTED ABOVE, BE LIABLE TO YOU FOR DAMAGES, INCLUDING ANY GENERAL, SPECIAL, INCIDENTAL OR CONSEQUENTIAL DAMAGES ARISING OUT OF THE USE OR INABILITY TO USE THE LIBRARY (INCLUDING BUT NOT LIMITED TO LOSS OF DATA OR DATA BEING RENDERED INACCURATE OR LOSSES SUSTAINED BY YOU OR THIRD PARTIES OR A FAILURE OF THE LIBRARY TO OPERATE WITH ANY OTHER SOFTWARE), EVEN IF SUCH HOLDER OR OTHER PARTY HAS BEEN ADVISED OF THE POSSIBILITY OF SUCH DAMAGES.

## END OF TERMS AND CONDITIONS

How to apply these terms to your new libraries

If you develop a new library, and you want it to be of the greatest possible use to the public, we recommend making

it free software that everyone can redistribute and change. You can do so by permitting redistribution under these terms (or, alternatively, under the terms of the ordinary General Public License).

To apply these terms, attach the following notices to the library. It is safest to attach them to the start of each source file to most effectively convey the exclusion of warranty; and each file should have at least the "copyright" line and a pointer to where the full notice is found.

one line to give the library's name and a brief idea of what it does.

Copyright (C) <year> <name of author>

This library is free software; you can redistribute it and/or modify it under the terms of the GNU Lesser General Public License as published by the Free Software Foundation; either version 2.1 of the license, or (at your option) any later version.

This library is distributed in the hope that it will be useful, but WITHOUT ANY WARRANTY; without even the implied warranty of MERCHANTABILITY or FITNESS FOR A PARTICULAR PURPOSE. See the GNU Lesser General Public License for more details.

You should have received a copy of the GNU Lesser General Public License along with this library; if not, write to the Free Software Foundation, Inc., 51 Franklin Street, Fifth Floor, Boston, MA 02110-1301 USA

Also add information on how to contact you by electronic and paper mail.

You should also get your employer (if you work as a programmer) or your school, if any, to sign a "copyright disclaimer" for the library, if necessary. Here is a sample; alter the names:

Yoyodyne, Inc., hereby disclaims all copyright interest in the library 'Frob' (a library for tweaking knobs) written by James Random Hacker.

signature of Ty Coon, 1 April 1990  
Ty Coon, President of Vice

# MOZILLA PUBLIC LICENSE

Version 1.1

-----

## 1. Definitions.

- 1.0.1. "Commercial use" means distribution or otherwise making the covered code available to a third party.
- 1.1. "Contributor" means each entity that creates or contributes to the creation of modifications.
- 1.2. "Contributor version" means the combination of the original code, prior modifications used by a contributor, and the modifications made by that particular contributor.
- 1.3. "Covered code" means the original code or modifications or the combination of the original code and modifications, in each case including portions thereof.
- 1.4. "Electronic distribution mechanism" means a mechanism generally accepted in the software development community for the electronic transfer of data.
- 1.5. "Executable" means covered code in any form other than source code.
- 1.6. "Initial developer" means the individual or entity identified as the initial Developer in the Source Code notice required by exhibit A.
- 1.7. "Larger work" means a work which combines covered code or portions thereof with code not governed by the terms of this License.
- 1.8. "License" means this document.
- 1.8.1. "Licensable" means having the right to grant, to the maximum extent possible, whether at the time of the initial grant or subsequently acquired, any and all of the rights conveyed herein.
- 1.9. "Modifications" means any addition to or deletion from the substance or structure of either the original code or any previous modifications. When covered code is released as a series of files, a modification is:
  - A. Any addition to or deletion from the contents of a file containing original code or previous modifications.
  - B. Any new file that contains any part of the original code or previous modifications.
- 1.10. "Original code" means source code of computer software code which is described in the source code notice required by exhibit as original code, and

which, at the time of its release under this license is not already covered code governed by this license.

- 1.10.1. "Patent claims" means any patent claim(s), now owned or hereafter acquired, including without limitation, method, process, and apparatus claims, in any patent licensable by grantor.
- 1.11. "Source code" means the preferred form of the covered code for making modifications to it, including all modules it contains, plus any associated interface definition files, scripts used to control compilation and installation of an executable, or source code differential comparisons against either the original code or another well known, available covered code of the contributor's choice. The source code can be in a compressed or archival form, provided the appropriate decompression or de-archiving software is widely available for no charge.
- 1.12. "You" (or "Your") means an individual or a legal entity exercising rights under, and complying with all of the terms of, this license or a future version of this license issued under section 6.1. For legal entities, "You" includes any entity which controls, is controlled by, or is under common control with You. For purposes of this definition, "control" means (a) the power, direct or indirect, to cause the direction or management of such entity, whether by contract or otherwise, or (b) ownership of more than fifty percent (50%) of the outstanding shares or beneficial ownership of such entity.

## 2. Source Code License.

- 2.1. The initial developer grant.  
The initial developer hereby grants You a world-wide, royalty-free, non-exclusive license, subject to third party intellectual property claims:
  - a) under intellectual property rights (other than patent or trademark) licensable by initial developer to use, reproduce, modify, display, perform, sublicense and distribute the original code (or portions thereof) with or without modifications, and/or as part of a larger work; and
  - (b) under patents claims infringed by the making, using or selling of original code, to make, have made, use, practice, sell, and offer for sale, and/or otherwise dispose of the original code (or portions thereof).

# APPENDIX

- (c) the licenses granted in this section 2.1(a) and (b) are effective on the date Initial developer first distributes original code under the terms of this license.
- (d) Notwithstanding section 2.1(b) above, no patent license is granted: 1) for code that You delete from the original Code; 2) separate from the original code; or 3) for infringements caused by:
  - i) the modification of the original code or ii) the combination of the original code with other software or devices.

## 2.2. Contributor Grant.

Subject to third party intellectual property claims, each contributor hereby grants You a world-wide, royalty-free, non-exclusive license

- (a) under intellectual property rights (other than patent or trademark) licensable by contributor, to use, reproduce, modify, display, perform, sublicense and distribute the modifications created by such contributor (or portions thereof) either on an unmodified basis, with other modifications, as covered code and/or as part of a larger work; and
- (b) under patent claims infringed by the making, using, or selling of modifications made by that contributor either alone and/or in combination with its contributor version (or portions of such combination), to make, use, sell, offer for sale, have made, and/or otherwise dispose of: 1) modifications made by that contributor (or portions thereof); and 2) the combination of modifications made by that contributor with its contributor version (or portions of such combination).
- (c) the licenses granted in sections 2.2(a) and 2.2(b) are effective on the date contributor first makes commercial use of the covered code.
- (d) Notwithstanding section 2.2(b) above, no patent license is granted: 1) for any code that contributor has deleted from the contributor version; 2) separate from the contributor version; 3) for infringements caused by: i) third party modifications of contributor version or ii) the combination of modifications made by that contributor with other software (except as part of the contributor version) or other devices; or 4) under patent claims infringed by covered code in the absence of modifications made by that contributor.

## 3. Distribution Obligations.

### 3.1. Application of license.

The modifications which You create or to which you contribute are governed by the terms of this license, including without limitation section 2.2. The source code version of covered code may be distributed only under the terms of this license or a future version of this license released under section 6.1, and you must include a copy of this license with every copy of the source code you distribute. You may not

offer or impose any terms on any source code version that alters or restricts the applicable version of this license or the recipients' rights hereunder. However, you may include an additional document offering the additional rights described in section 3.5.

### 3.2. Availability of source code.

Any modification which you create or to which you contribute must be made available in source code form under the terms of this license either on the same media as an executable version or via an accepted electronic distribution mechanism to anyone to whom you made an executable version available; and if made available via electronic distribution mechanism, must remain available for at least twelve (12) months after the date it initially became available, or at least six (6) months after a subsequent version of that particular modification has been made available to such recipients. You are responsible for ensuring that the source code version remains available even if the electronic distribution mechanism is maintained by a third party.

### 3.3. Description of modifications.

You must cause all covered code to which you contribute to contain a file documenting the changes You made to create that covered code and the date of any change. You must include a prominent statement that the modification is derived, directly or indirectly, from original code provided by the initial developer and including the name of the initial developer in (a) the source code, and (b) in any notice in an executable version or related documentation in which you describe the origin or ownership of the covered code.

### 3.4. Intellectual property matters

#### (a) Third party claims.

If contributor has knowledge that a license under a third party's intellectual property rights is required to exercise the rights granted by such contributor under sections 2.1 or 2.2, contributor must include a text file with the source code distribution titled "LEGAL" which describes the claim and the party making the claim in sufficient detail that a recipient will know whom to contact. If contributor obtains such knowledge after the modification is made available as described in section 3.2, contributor shall promptly modify the LEGAL file in all copies contributor makes available thereafter and shall take other steps (such as notifying appropriate mailing lists or newsgroups) reasonably calculated to inform those who received the covered code that new knowledge has been obtained.

#### (b) Contributor APIs.

If contributor's modifications include an application programming interface and contributor has knowledge of patent licenses which are reasonably necessary to implement that API, contributor must also include this information in the LEGAL file.

(c) Representations.

contributor represents that, except as disclosed pursuant to section 3.4(a) above, contributor believes that contributor's modifications are contributor's original creation(s) and/or contributor has sufficient rights to grant the rights conveyed by this license.

3.5. Required notices.

You must duplicate the notice in exhibit A in each file of the source code. If it is not possible to put such notice in a particular source code file due to its structure, then You must include such notice in a location (such as a relevant directory) where a user would be likely to look for such a notice. If You created one or more modification(s), you may add your name as a contributor to the notice described in exhibit A. you must also duplicate this license in any documentation for the source code where You describe recipients' rights or ownership rights relating to covered code. You may choose to offer, and to charge a fee for, warranty, support, indemnity or liability obligations to one or more recipients of covered code. However, you may do so only on your own behalf, and not on behalf of the Initial developer or any contributor. You must make it absolutely clear than any such warranty, support, indemnity or liability obligation is offered by you alone, and You hereby agree to indemnify the Initial developer and every contributor for any liability incurred by the Initial developer or such contributor as a result of warranty, support, indemnity or liability terms you offer.

3.6. Distribution of executable versions.

You may distribute covered code in executable form only if the requirements of section 3.1-3.5 have been met for that covered code, and if you include a notice stating that the source code version of the covered code is available under the terms of this license, including a description of how and where you have fulfilled the obligations of section 3.2. The notice must be conspicuously included in any notice in an executable version, related documentation or collateral in which you describe recipients' rights relating to the covered code. You may distribute the executable version of covered code or ownership rights under a license of your choice, which may contain terms different from this license, provided that you are in compliance with the terms of this license and that the license for the executable version does not attempt to limit or alter the recipient's rights in the source code version from the rights set forth in this license. If you distribute the executable version under a different license you must make it absolutely clear that any terms which differ from this license are offered by you alone, not by the Initial developer or any contributor. You hereby agree to indemnify the initial developer and every contributor for any liability incurred by the initial developer or such contributor as a result of any such terms You offer.

3.7. Larger works.

You may create a larger work by combining covered

code with other code not governed by the terms of this license and distribute the larger work as a single product. In such a case, you must make sure the requirements of this license are fulfilled for the covered code.

4. Inability to comply due to statute or regulation.

If it is impossible for you to comply with any of the terms of this license with respect to some or all of the covered code due to statute, judicial order, or regulation then you must: (a) comply with the terms of this license to the maximum extent possible; and (b) describe the limitations and the code they affect. Such description must be included in the LEGAL file described in section 3.4 and must be included with all distributions of the source code. Except to the extent prohibited by statute or regulation, such description must be sufficiently detailed for a recipient of ordinary skill to be able to understand it.

5. Application of this license.

This license applies to code to which the initial developer has attached the notice in exhibit A and to related covered code.

6. Versions of the license.

6.1. New versions.

Netscape communications corporation ("Netscape") may publish revised and/or new versions of the license from time to time. Each version will be given a distinguishing version number.

6.2. Effect of new versions.

Once covered code has been published under a particular version of the license, you may always continue to use it under the terms of that version. You may also choose to use such covered code under the terms of any subsequent version of the license published by netscape. No one other than netscape has the right to modify the terms applicable to covered code created under this license.

6.3. Derivative works.

If You create or use a modified version of this license (which you may only do in order to apply it to code which is not already covered code governed by this license), You must (a) rename Your license so that the phrases "Mozilla", "MOZILLAPL", "MOZPL", "Netscape", "MPL", "NPL" or any confusingly similar phrase do not appear in your license (except to note that your license differs from this license) and (b) otherwise make it clear that Your version of the license contains terms which differ from the Mozilla Public license and netscape Public License. (Filling in the name of the initial developer, original code or contributor in the notice described in exhibit A shall not of themselves be deemed to be modifications of this license.)

# APPENDIX

## 7. DISCLAIMER OF WARRANTY.

COVERED CODE IS PROVIDED UNDER THIS LICENSE ON AN "AS IS" BASIS, WITHOUT WARRANTY OF ANY KIND, EITHER EXPRESSED OR IMPLIED, INCLUDING, WITHOUT LIMITATION, WARRANTIES THAT THE COVERED CODE IS FREE OF DEFECTS, MERCHANTABLE, FIT FOR A PARTICULAR PURPOSE OR NON-INFRINGEMENT. THE ENTIRE RISK AS TO THE QUALITY AND PERFORMANCE OF THE COVERED CODE IS WITH YOU. SHOULD ANY COVERED CODE PROVE DEFECTIVE IN ANY RESPECT, YOU (NOT THE INITIAL DEVELOPER OR ANY OTHER CONTRIBUTOR) ASSUME THE COST OF ANY NECESSARY SERVICING, REPAIR OR CORRECTION. THIS DISCLAIMER OF WARRANTY CONSTITUTES AN ESSENTIAL PART OF THIS LICENSE. NO USE OF ANY COVERED CODE IS AUTHORIZED HEREUNDER EXCEPT UNDER THIS DISCLAIMER.

## 8. TERMINATION.

8.1. This license and the rights granted hereunder will terminate automatically if you fail to comply with terms herein and fail to cure such breach within 30 days of becoming aware of the breach. All sublicenses to the covered code which are properly granted shall survive any termination of this license. Provisions which, by their nature, must remain in effect beyond the termination of this license shall survive.

8.2. If you initiate litigation by asserting a patent infringement claim (excluding declaratory judgment actions) against initial developer or a contributor (the initial developer or contributor against whom you file such action is referred to as "Participant") alleging that:

(a) such participant's contributor version directly or indirectly infringes any patent, then any and all rights granted by such participant to you under sections 2.1 and/or 2.2 of this license shall, upon 60 days notice from Participant terminate prospectively, unless if within 60 days after receipt of notice you either: (i) agree in writing to pay participant a mutually agreeable reasonable royalty for your past and future use of modifications made by such participant, or (ii) withdraw your litigation claim with respect to the contributor version against such participant. If within 60 days of notice, a reasonable royalty and payment arrangement are not mutually agreed upon in writing by the parties or the litigation claim is not withdrawn, the rights granted by participant to you under sections 2.1 and/or 2.2 automatically terminate at the expiration of the 60 day notice period specified above.

(b) any software, hardware, or device, other than such participant's contributor Version, directly or indirectly infringes any patent, then any rights granted

to You by such participant under sections 2.1(b) and 2.2(b) are revoked effective as of the date you first made, used, sold, distributed, or had made, modifications made by that participant.

8.3. If you assert a patent infringement claim against participant alleging that such participant's contributor version directly or indirectly infringes any patent where such claim is resolved (such as by license or settlement) prior to the initiation of patent infringement litigation, then the reasonable value of the licenses granted by such participant under sections 2.1 or 2.2 shall be taken into account in determining the amount or value of any payment or license.

8.4. In the event of termination under sections 8.1 or 8.2 above, all end user license agreements (excluding distributors and resellers) which have been validly granted by you or any distributor hereunder prior to termination shall survive termination.

## 9. LIMITATION OF LIABILITY.

UNDER NO CIRCUMSTANCES AND UNDER NO LEGAL THEORY, WHETHER TORT (INCLUDING NEGLIGENCE), CONTRACT, OR OTHERWISE, SHALL YOU, THE INITIAL DEVELOPER, ANY OTHER CONTRIBUTOR, OR ANY DISTRIBUTOR OF COVERED CODE, OR ANY SUPPLIER OF ANY OF SUCH PARTIES, BE LIABLE TO ANY PERSON FOR ANY INDIRECT, SPECIAL, INCIDENTAL, OR CONSEQUENTIAL DAMAGES OF ANY CHARACTER INCLUDING, WITHOUT LIMITATION, DAMAGES FOR LOSS OF GOODWILL, WORK STOPPAGE, COMPUTER FAILURE OR MALFUNCTION, OR ANY AND ALL OTHER COMMERCIAL DAMAGES OR LOSSES, EVEN IF SUCH PARTY SHALL HAVE BEEN INFORMED OF THE POSSIBILITY OF SUCH DAMAGES. THIS LIMITATION OF LIABILITY SHALL NOT APPLY TO LIABILITY FOR DEATH OR PERSONAL INJURY RESULTING FROM SUCH PARTY'S NEGLIGENCE TO THE EXTENT APPLICABLE LAW PROHIBITS SUCH LIMITATION. SOME JURISDICTIONS DO NOT ALLOW THE EXCLUSION OR LIMITATION OF INCIDENTAL OR CONSEQUENTIAL DAMAGES, SO THIS EXCLUSION AND LIMITATION MAY NOT APPLY TO YOU.

## 10. U.S. GOVERNMENT END USERS.

The covered code is a "commercial item," as that term is defined in 48 C.F.R. 2.101 (Oct. 1995), consisting of "commercial computer software" and "commercial computer software documentation," as such terms are used in 48 C.F.R. 12.212 (Sept. 1995). Consistent with 48 C.F.R. 12.212 and 48 C.F.R. 227.7202-1 through 227.7202-4 (June 1995), all U.S. Government end users acquire covered code with only those rights set forth herein.

## 11. MISCELLANEOUS.

This license represents the complete agreement concerning subject matter hereof. If any provision of this license is held to be unenforceable, such provision shall be reformed only to the extent necessary to make it enforceable. This License shall be governed by California law provisions (except to the extent applicable law, if any, provides otherwise), excluding its conflict-of-law provisions. With respect to disputes in which at least one party is a citizen of, or an entity chartered or registered to do business in the united states of america, any litigation relating to this License shall be subject to the jurisdiction of the federal courts of the northern district of california, with venue lying in santa clara county, california, with the losing party responsible for costs, including without limitation, court costs and reasonable attorneys' fees and expenses. The application of the united nations convention on contracts for the International sale of goods is expressly excluded. Any law or regulation which provides that the language of a contract shall be construed against the drafter shall not apply to this license.

## 12. RESPONSIBILITY FOR CLAIMS.

As between initial developer and the contributors, each party is responsible for claims and damages arising, directly or indirectly, out of its utilization of rights under this license and you agree to work with initial developer and contributors to distribute such responsibility on an equitable basis. Nothing herein is intended or shall be deemed to constitute any admission of liability.

## 13. MULTIPLE-LICENSED CODE.

Initial developer may designate portions of the covered code as "Multiple-Licensed". "Multiple-Licensed" means that the initial developer permits you to utilize portions of the covered code under your choice of the NPL or the alternative licenses, if any, specified by the initial developer in the file described in exhibit A.

EXHIBIT A -Mozilla Public License.

The contents of this file are subject to the Mozilla Public License Version 1.1 (the "license"); you may not use this file except in compliance with the License. You may obtain a copy of the license at <http://www.mozilla.org/MPL/>

Software distributed under the license is distributed on an "AS IS" basis, WITHOUT WARRANTY OF ANY KIND, either express or implied. See the license for the specific language governing rights and limitations under the License.

The Original Code is \_\_\_\_\_  
.

The Initial Developer of the Original Code is \_\_\_\_\_.

Portions created by \_\_\_\_\_ are Copyright (C) \_\_\_\_\_. All Rights Reserved.

Contributor(s): \_\_\_\_\_.

Alternatively, the contents of this file may be used under the terms of the \_\_\_\_ license (the "[\_] License"), in which case the provisions of [\_\_\_\_] license are applicable instead of those above. If you wish to allow use of your version of this file only under the terms of the [\_\_\_\_] license and not to allow others to use your version of this file under the MPL, indicate your decision by deleting the provisions above and replace them with the notice and other provisions required by the [\_\_\_\_] license. If you do not delete the provisions above, a recipient may use your version of this file under either the MPL or the [\_\_\_\_] license."

NOTE: The text of this exhibit A may differ slightly from the text of the notices in the source code files of the original code. You should use the text of this exhibit A rather than the text found in the original code/source code for Your modifications.



The model and serial number of the TV is located on the back and/or one side of the TV. Record it below should you ever need service.

MODEL \_\_\_\_\_

SERIAL \_\_\_\_\_