



website <http://www.lgservice.com>

LG

MULTI V™ System Heat Pump Indoor Unit ***INSTALLATION MANUAL***

MODELS: LRNN, LRNV-TC Series
Type: Ceiling Mounted Cassette - 1Way

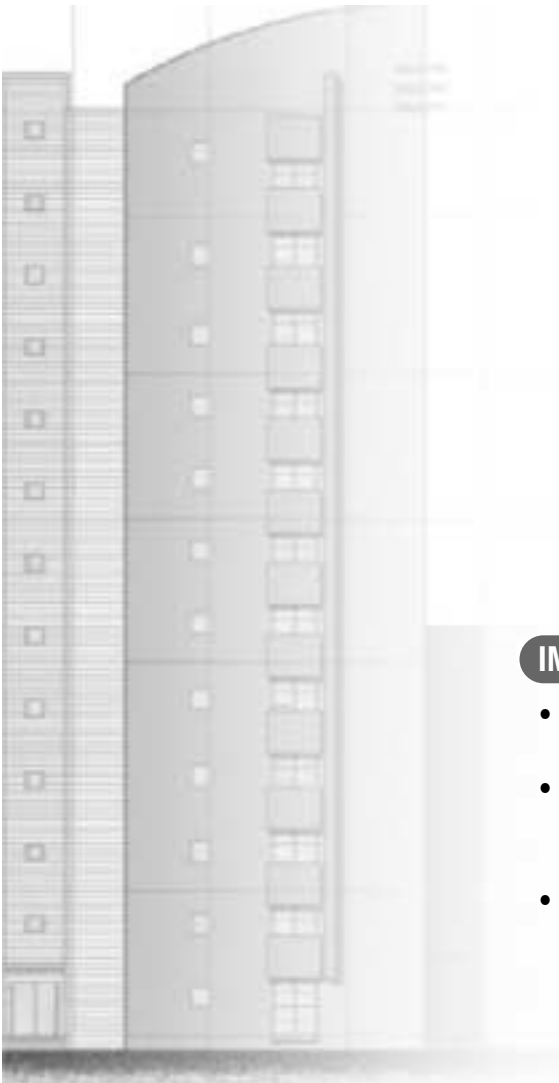

IMPORTANT



- Please read this installation manual completely before installing the product.
- Installation work must be performed in accordance with the national wiring standards by authorized personnel only.
- Please retain this installation manual for future reference after reading it thoroughly.

TABLE OF CONTENTS

<i>Installation Requirements</i>	<i>Required Parts</i>	<i>Required Tools</i>
Installation Parts Provided3		
Safety Precautions4		
Installation	<input type="checkbox"/> Installation guide map <input type="checkbox"/> Four type "A" screws & plastic anchors <input type="checkbox"/> Connecting cable	<input type="checkbox"/> Level gauge <input type="checkbox"/> Screw driver <input type="checkbox"/> Electric drill <input type="checkbox"/> Hole core drill <input type="checkbox"/> Horizontal meter
Selection the best location7		<input type="checkbox"/> Flaring tool set <input type="checkbox"/> Specified torque wrenches (different depending on model No.) <input type="checkbox"/> SpannerHalf union
Ceiling opening dimension and hanging bolt location8	<input type="checkbox"/> Pipes: Gas side Liquid side (Refer to Product Data) <input type="checkbox"/> Insulation materials <input type="checkbox"/> Additional drain pipe	
Wiring Connection9		<input type="checkbox"/> A glass of water <input type="checkbox"/> Screw driver
Check the Drainage.....10		
Installation of Remote Control.....13		
Drain Pipe Work.....14		<input type="checkbox"/> Hexagonal wrench <input type="checkbox"/> Gas-leak detector <input type="checkbox"/> Vacuum pump <input type="checkbox"/> Gauge manifold
Installation of Drain Pump ...16		
Optional Operation18	<input type="checkbox"/> Two type "B" screws	<input type="checkbox"/> Owner's manual <input type="checkbox"/> Thermometer

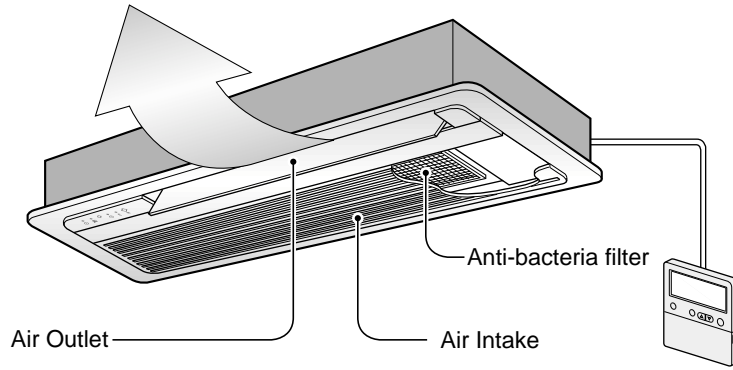
Installation

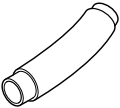

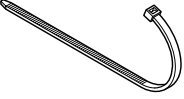
Name	Clamp metal	Drain hose	Insulation for fitting	Washer for hanging bracket	Clamp	(Other)
Quantity	2 EA	1 EA	1 set	8 EA	7 EA	<ul style="list-style-type: none"> • Paper pattern for installation • Owner's manual • Installation manual
Shape			 for gas pipe for liquid pipe			

- Screws for fixing panels are attached to decoration panel.

Safety Precautions



To prevent injury to the user or other people and property damage, the following instructions must be followed.

- Be sure to read before installing the air conditioner.
- Be sure to observe the cautions specified here as they include important items related to safety.
- Incorrect operation due to ignoring instruction will cause harm or damage. The seriousness is classified by the following indications.

⚠ WARNING This symbol indicates the possibility of death or serious injury.

⚠ CAUTION This symbol indicates the possibility of injury or damage to properties only.

- Meanings of symbols used in this manual are as shown below.

	Be sure not to do.
	Be sure to follow the instruction.

⚠ WARNING

■ Installation

Do not use a defective or under-rated circuit breaker. Use this appliance on a dedicated circuit.

- There is risk of fire or electric shock.

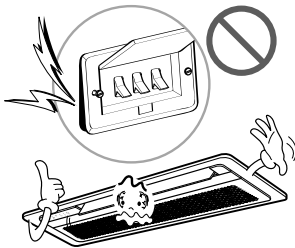

For electrical work, contact the dealer, seller, a qualified electrician, or an Authorized Service Center.

- Do not disassemble or repair the product. There is risk of fire or electric shock.



Always ground the product.

- There is risk of fire or electric shock.

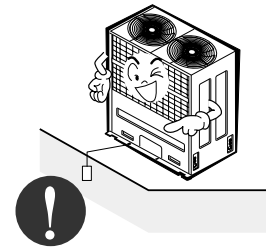

Install the panel and the cover of control box securely.

- There is risk of fire or electric shock.

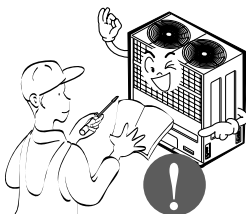

Always install a dedicated circuit and breaker.

- Improper wiring or installation may cause fire or electric shock

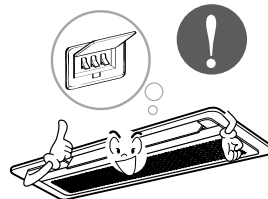

Use the correctly rated breaker or fuse.

- There is risk of fire or electric shock.

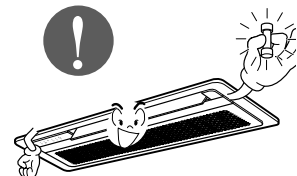

Do not modify or extend the power cable.

- There is risk of fire or electric shock.

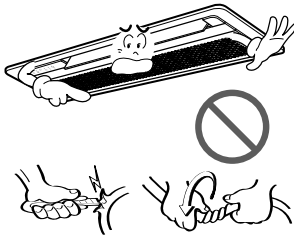

Do not let the air conditioner run for a long time when the humidity is very high and a door or a window is left open.

- Moisture may condense and wet or damage furniture.

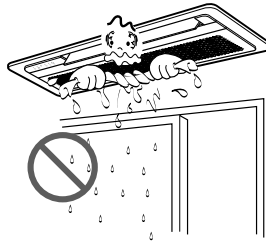

Be cautious when unpacking and installing the product.

- Sharp edges could cause injury. Be especially careful of the case edges and the fins on the condenser and evaporator.

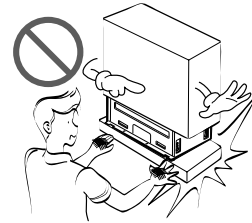

For installation, always contact the dealer or an Authorized Service Center.

- There is risk of fire, electric shock, explosion, or injury.

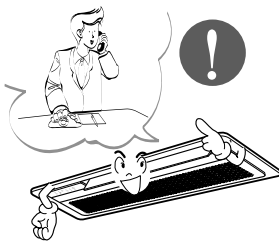

Do not install the product on a defective installation stand.

- It may cause injury, accident, or damage to the product.

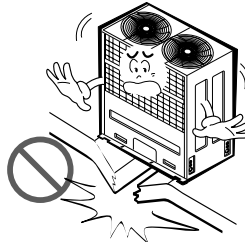

Be sure the installation area does not deteriorate with age.

- If the base collapses, the air conditioner could fall with it, causing property damage, product failure, and personal injury.

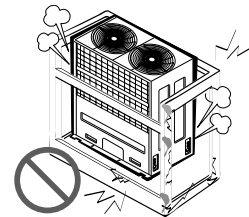

■ Operation

Do not store or use flammable gas or combustibles near the product.

- There is risk of fire or failure of product.

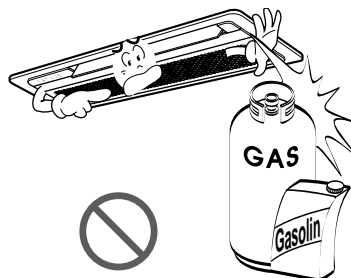

CAUTION

Installation

Always check for gas (refrigerant) leakage after installation or repair of product.

- Low refrigerant levels may cause failure of product.

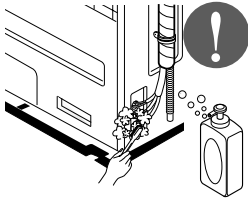

Install the drain hose to ensure that water is drained away properly.

- A bad connection may cause water leakage.

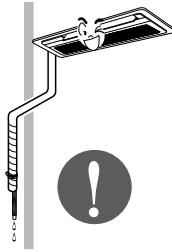

Keep level even when installing the product.

- To avoid vibration or water leakage.

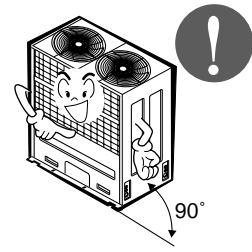

Do not install the product where the noise or hot air from the outdoor unit could damage the neighborhoods.

- It may cause a problem for your neighbors.

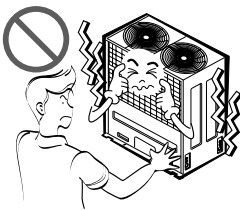

Use two or more people to lift and transport the product.

- Avoid personal injury.

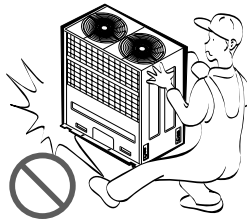

Do not install the product where it will be exposed to sea wind (salt spray) directly.

- It may cause corrosion on the product. Corrosion, particularly on the condenser and evaporator fins, could cause product malfunction or inefficient operation.

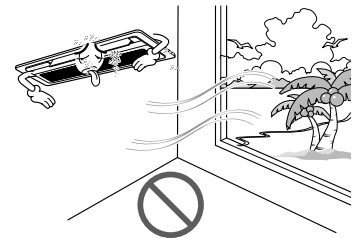

Installation

Read completely, then follow step by step.

Selection of the best location

- There should not be any heat source or steam near the unit.
- There should not be any obstacles to the air circulation.
- A place where air circulation in the room will be good.
- A place where drainage can be easily obtained.
- A place where noise prevention is taken into consideration.
- Do not install the unit near the door way.
- Ensure the spaces indicated by arrows from the wall, ceiling, or other obstacles.
- The indoor unit must have the maintenance space.

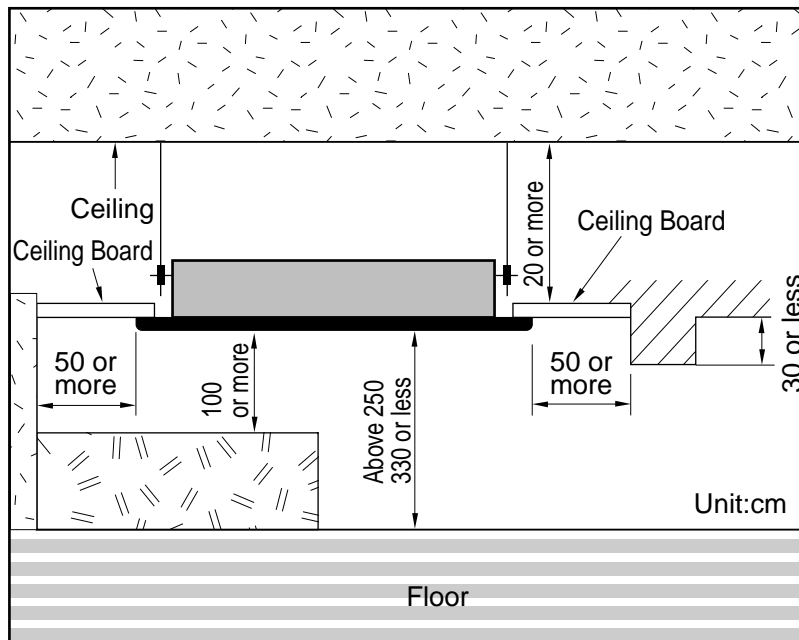

CAUTION : In case that the unit is installed near the sea, the installation parts may be corroded by salt, The installation parts (and the unit) should be taken appropriate anti-corrosion measures.

Ceiling dimension and hanging bolt location

- The dimensions of the paper pattern for installation are the same as those of the ceiling opening dimensions.

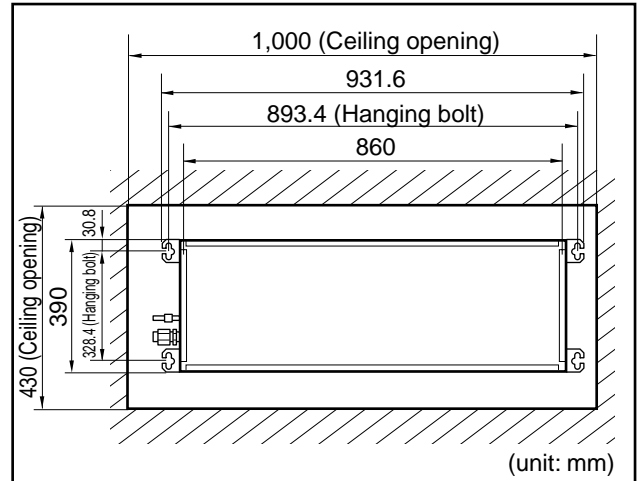
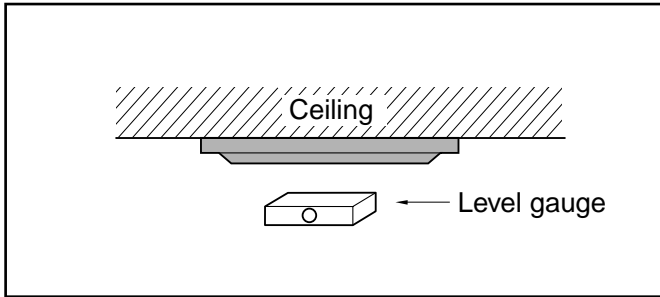

CAUTION :

- This air-conditioner uses a drain pump.
- Install the unit horizontally using a level gauge.
- During the installation, care should be taken not to damage electric wires.
- Select and mark the position for fixing bolts and piping hole.
- Decide the position for fixing bolts slightly tilted to the drain direction after considering the direction of drain hose.
- Drill the hole for anchor bolt on the wall.

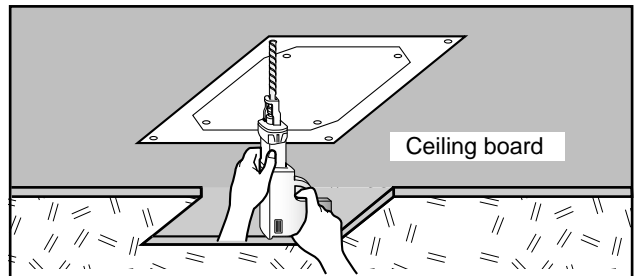

NOTICE

- Avoid the following installation location.
 1. Such places as restaurants and kitchen where considerable amount of oil steam and flour is generated. These may cause heat exchange efficiency reduction, or water drops, drain pump mal-function. In these cases, take the following actions;
 - Make sure that ventilation fan is enough to cover all noxious gases from this place.
 - Ensure enough distance from the cooking room to install the air conditioner in such a place where it may not suck oily steam.
 2. Avoid installing air conditioner in such places where cooking oil or iron powder is generated.
 3. Avoid places where inflammable gas is generated.
 4. Avoid place where noxious gas is generated.
 5. Avoid places near high frequency generators.

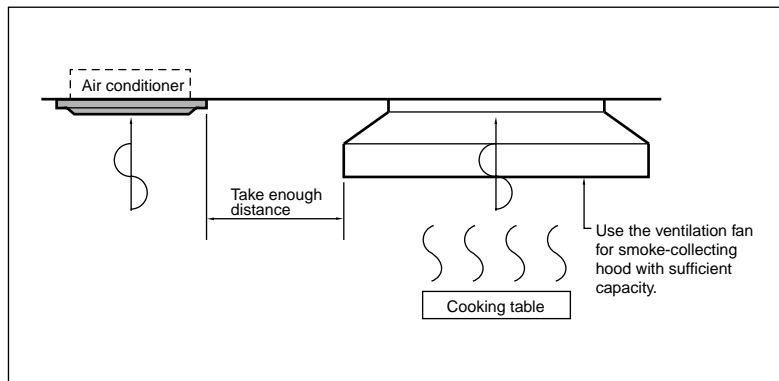

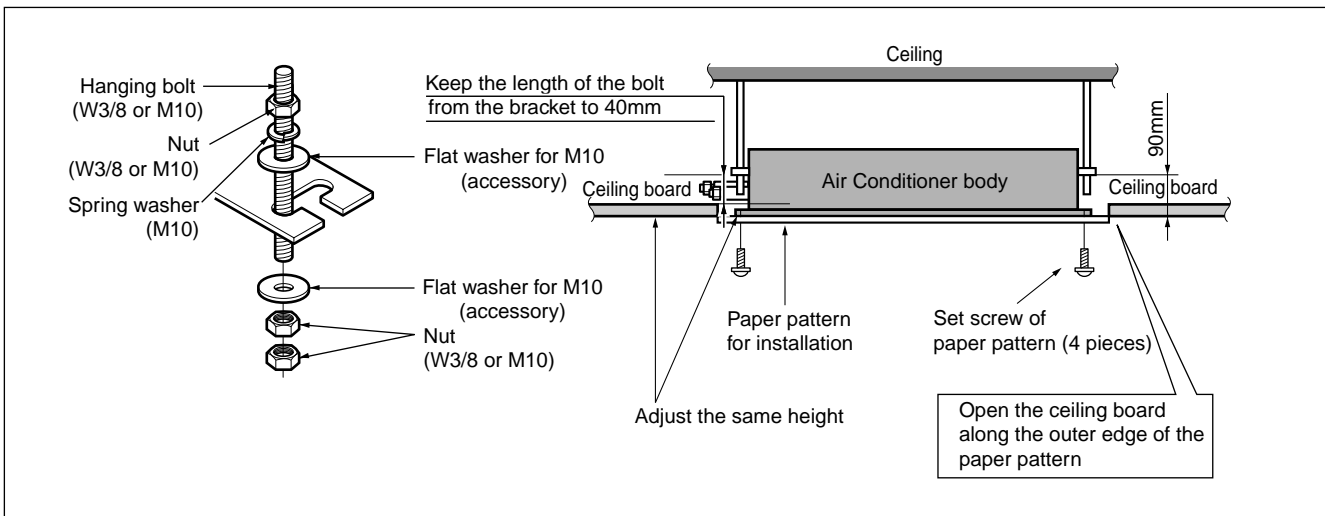

• The following parts are local purchasing.

- ① Hanging Bolt - W 3/8 or M10
- ② Nut - W 3/8 or M10
- ③ Spring Washer - M10
- ④ Plate Washer - M10

CAUTION : Tighten the nut and bolt to prevent unit from falling off.

Wiring Connection

• Open the control box cover and connect the Remote control cord and Indoor power wires.

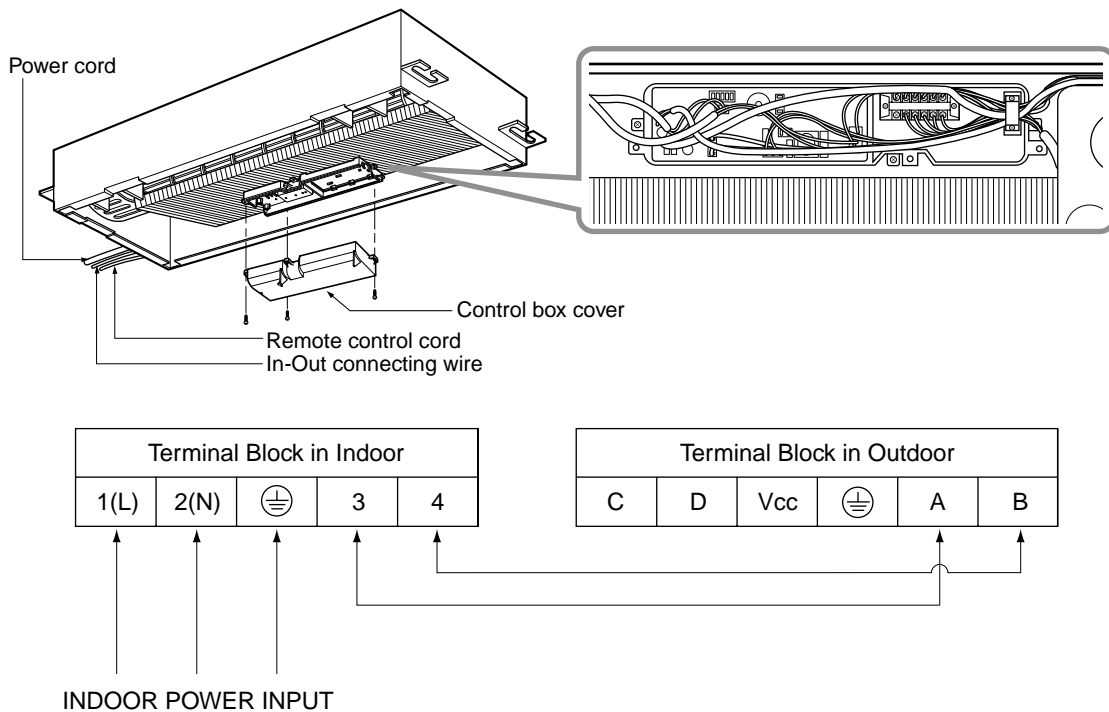

WARNING : Make sure that the screws of the terminal are free from looseness.

Installation of Decoration Panel

The decoration panel has its installation direction.

Before installing the decoration panel, always remove the paper template.

1. Temporarily fix two decoration panel fixing screws (hexagon M5 screw) on the unit body. (Tighten by amount 10mm in length.)
The fixing screws (hexagon M5 screw) are included the indoor unit box.
2. Remove the air inlet grille from the decoration panel. (Remove the hook for the air inlet grille cord.)
3. Hook the decoration panel key hole () on the screws fixed in step above, and slide the panel so that the screws reach the key hole edge.
4. Retighten completely two temporarily fixed screws and other two screws. (Total 4 screws)
5. Connect the louver motor connector and display connector.
6. After tightening these screws, install the air inlet grille (including the air filter).

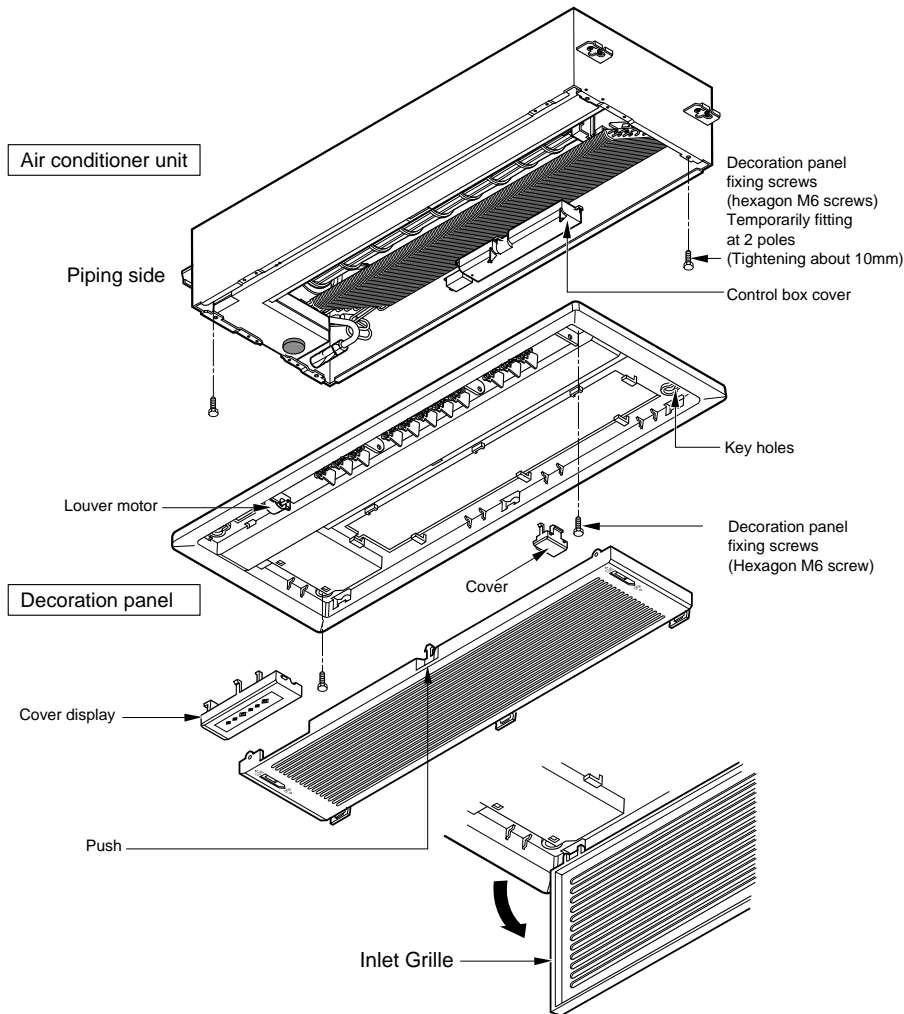

CAUTION : Install certainly the decoration panel. Cool air leakage causes sweating.  Water drops fall.

Good example

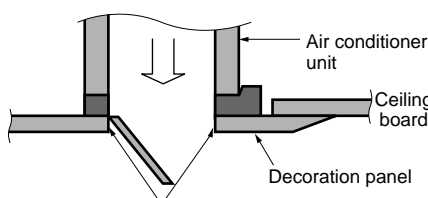

Bad example

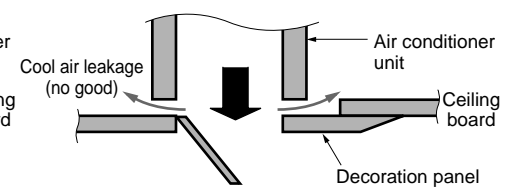

Fit the insulator (this part) and be careful for cool air leakage

Drain Piping

- Drain piping must have down-slope (1/50 to 1/100): be sure not to provide up-and-down slope to prevent reversal flow.
- During drain piping connection, be careful not to exert extra force on the drain port on the indoor unit.
- The outside diameter of the drain connection on the indoor unit is 32mm.

Piping material: Polyvinyl chloride pipe VP-25 and pipe fittings

- Be sure to install heat insulation on the drain piping.

Heat insulation material: Polyethylene foam with thickness more than 8 mm.

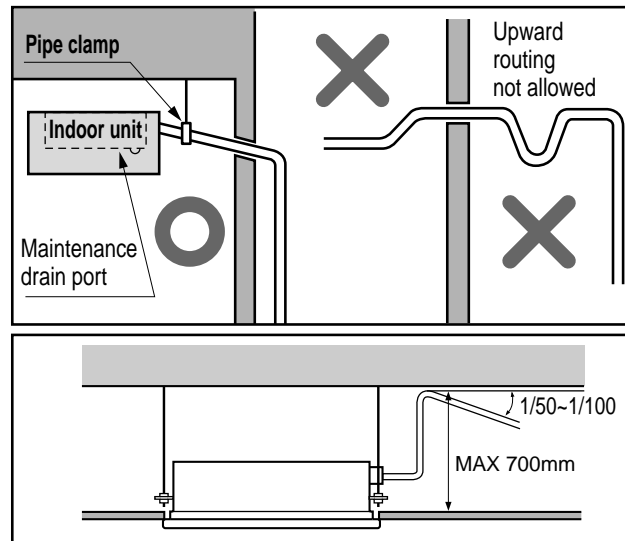

Drain test

The air conditioner uses a drain pump to drain water. Use the following procedure to test the drain pump operation:

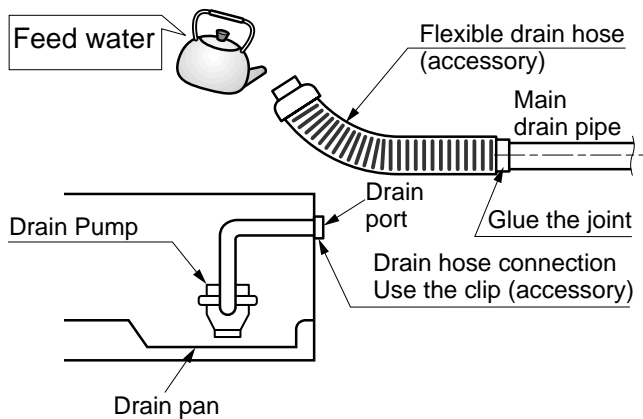

- Connect the main drain pipe to the exterior and leave it provisionally until the test comes to an end.
- Feed water to the flexible drain hose and check the piping for leakage.
- Be sure to check the drain pump for normal operating and noise when electrical wiring is complete.
- When the test is complete, connect the flexible drain hose to the drain port on the indoor unit.

CAUTION : The supplied flexible drain hose should not be curved, neither screwed. The curved or screwed hose may cause a leakage of water.

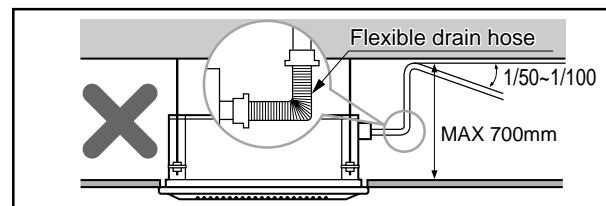



CAUTION:

After the confirmation of the above conditions, prepare the wiring as follows:

- 1) Never fail to have an individual power specialized for the air conditioner. As for the method of wiring, be guided by the circuit diagram pasted on the inside of control box cover.
- 2) Provide a circuit breaker switch between power source and the unit.
- 3) The screw which fasten the wiring in the casing of electrical fittings are liable to come loose from vibrations to which the unit is subjected during the course of transportation. Check them and make sure that they are all tightly fastened. (If they are loose, it could give rise to burn-out of the wires.)
- 4) Specification of power source
- 5) Confirm that electrical capacity is sufficient.
- 6) Be sure that the starting voltage is maintained at more than 90 percent of the rated voltage marked on the name plate.
- 7) Confirm that the cable thickness is as specified in the power sources specification. (Particularly note the relation between cable length and thickness.)
- 8) Never fail to equip a leakage breaker where it is wet or moist.
- 9) The following troubles would be caused by voltage drop-down.
 - Vibration of a magnetic switch, damage on the contact point there of, fuse breaking, disturbance to the normal function of a overload protection device.
 - Proper starting power is not given to the compressor.

HAND OVER

Teach the customer the operation and maintenance procedures, using the operation manual. (air filter cleaning, temperature control, etc.)

Installation of Remote Control

- Although the room temperature sensor is in the indoor unit, the remote control should be installed in such places away from direct sunlight and high humidity.

Installation of the remote control

- Select places that are not splashed with water.
- Select control position after receiving customer approval.
- The room temperature sensor is built in the indoor unit.
- This remote control equipped with liquid crystal display. If this position is higher or lower, display is difficult to see. (The standard height is 1.2 ~ 1.5m high)

Routing of the remote control cord

- Keep the remote control cord away from the refrigerant piping and the drain piping.
- To protect the remote control cord from electrical noise, place the cord at least 5cm away from other power cables (audio equipment, television set, etc.)
- If the remote control cord is secured to the wall, provide a trap at the top of the cord to prevent water droplets from running.



CAUTION : Use the wireless remote control with the wired.

If you want to use wireless alone, you should do following process.

- 1) Do auto addressing in connecting the wired.
- 2) After completing auto addressing, turn off the power and disconnect the wired.

WIRED REMOTE CONTROL INSTALLATION

DISASSEMBLING

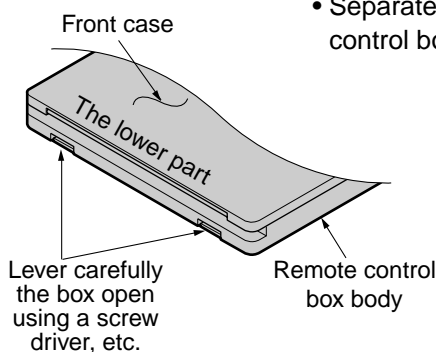

- Separate the under plate from Remote control box.
- Attach insulator to under plate.

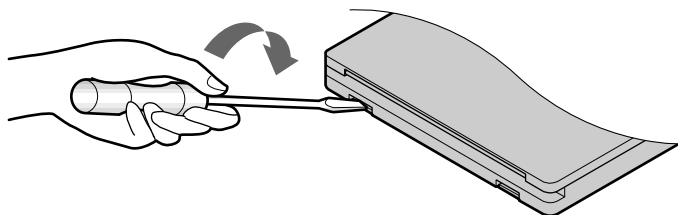

- Fix the under plate on the wall

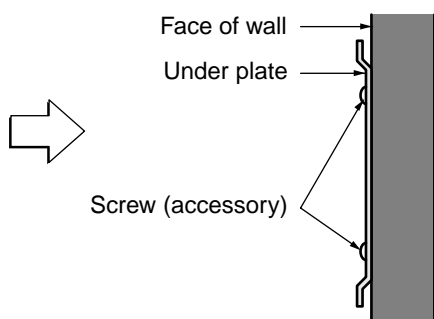

- Fix the cord clamps on the wall by $\varnothing 3$ tapping screws (accessory).
- Fix the remote control cord.

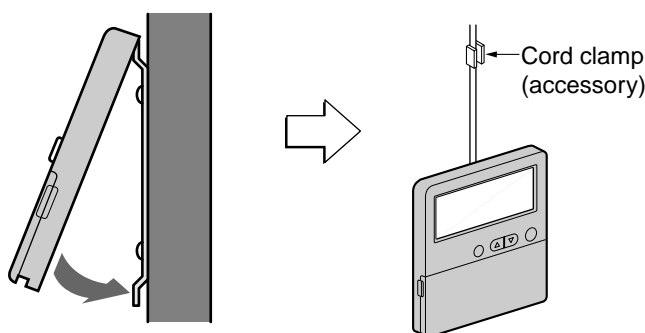

ELECTRICAL WIRING

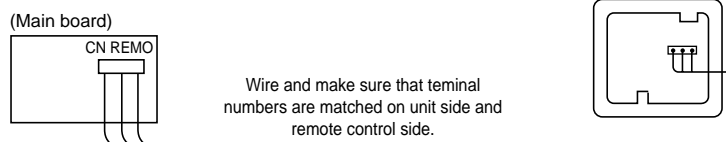

Wire and make sure that terminal numbers are matched on unit side and remote control side.

The maximum length of the cord is 100m.
If the length of the cord exceeds 50m,
use a wire size greater than 0.5mm².

Drain Pipe Work

1) Drain pipe gradient and support

- a) - The drain pipe must be fitted at a gradient of at least 1/100.
- The drain pipe should be as short as possible and free from airlocks.

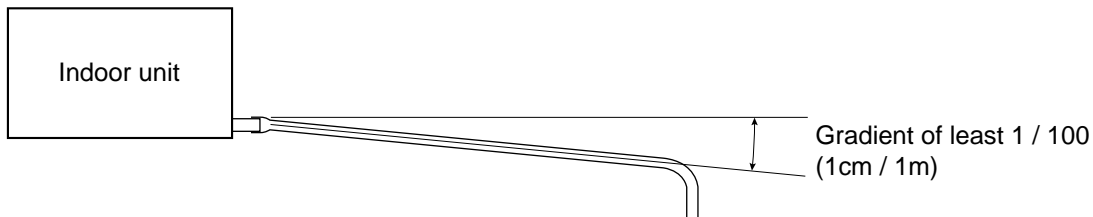

- b) - Suspension bolts should be used to support long stretches of drain pipe in order to ensure that a gradient of 1/100 is maintained (PVC pipe should not be bent)

Spacing of supports for horizontal piping

Class	Normal diameter	Spacing
Rigid PVC pipe	25~40mm	1.0m or less

- c) - The length of pipe laid horizontally should be kept a minimum.

2) Drain trap

Fit any indoor unit whose drain pipe connection is subjected to negative pressure, with a drain trap.

- a) Rig the drain trap shown in the drawing below.

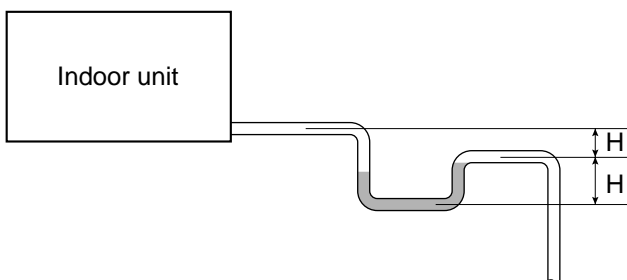

- b) Provide one trap per unit. A single trap for converging units will prove ineffective.

- c) Rig the trap to allow for future changing.

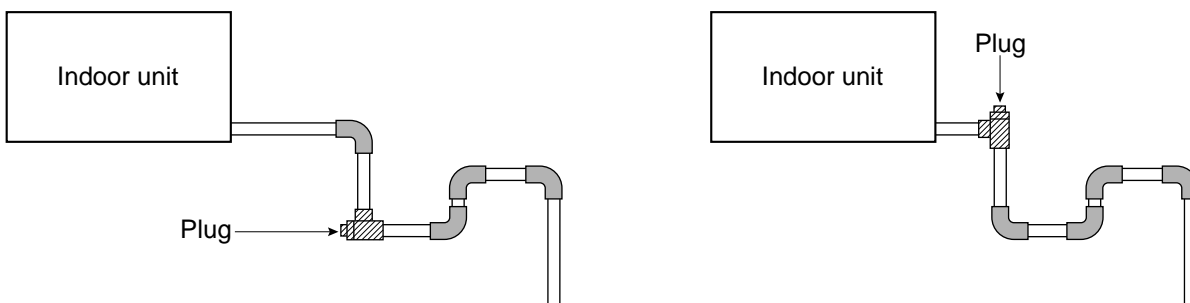

3) Ground drain piping

- a) It is standard work practice to make connections to the main pipe from above. The pipe down from the combination should be as large as possible.

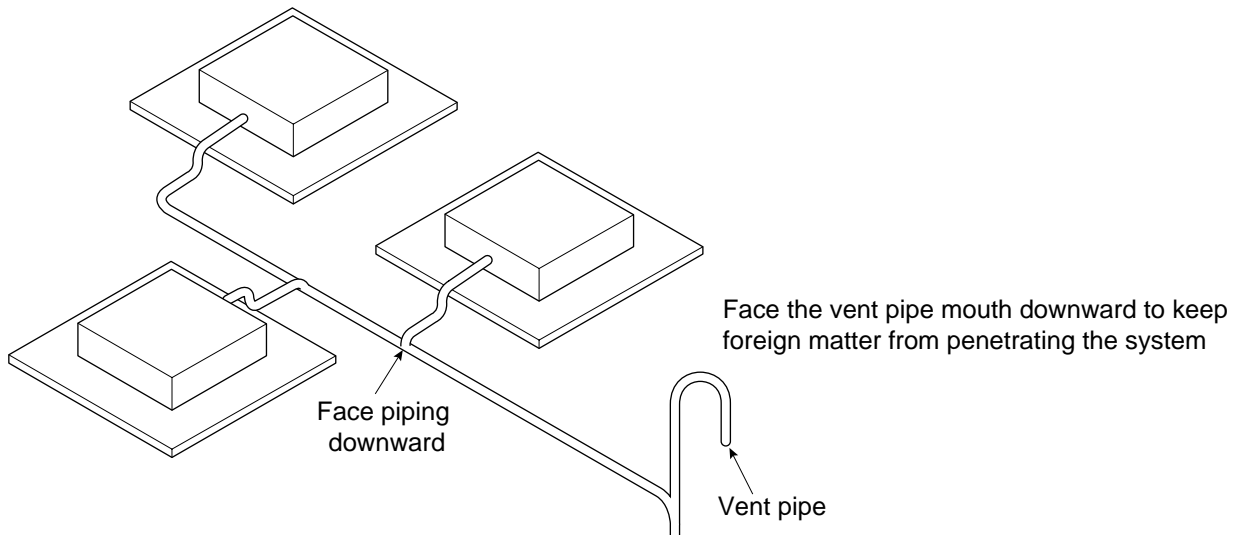

- b) The pipe work should be kept as short as possible and the number of indoor units per group kept to a minimum.

4) Use of an auxiliary drain hose(flexible)

- a) If the drain pan made of polystyrene foam is used then an auxiliary drain hose(flexible) is also essential. A flexible drain hose permits the drain socket and drain pipe to be connected without difficulty and prevents any undue strain being placed on the drain pan.

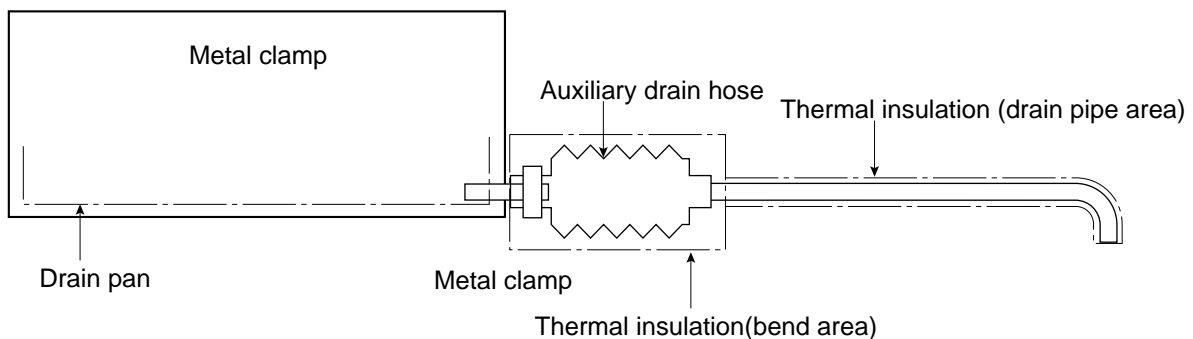

✱ Important points

- The drain pipe should be at least equal in size to that of the indoor unit.
- The drain pipe is thermally insulated to prevent the formation of condensation inside the pipe.
- The drain up mechanism should be fitted before the indoor unit is installed and when the electricity has been connected some water should be added to the drain pan and the drain pump checked to see that it is functioning correctly.
- All connections should be secure. (Special care is needed with PVC pipe)
- Insulate auxiliary drain hose with thermal insulation band.

Installation of drain pump

1) Safety First

- Cut off the power supply before installation and maintenance.
- Drain Pump Assy, Elbow and Hose must be installed at safe area where it is far away from the user.
- Drain Pump Assy must be installed at appointed location.
- All wiring and connections are for installation only.

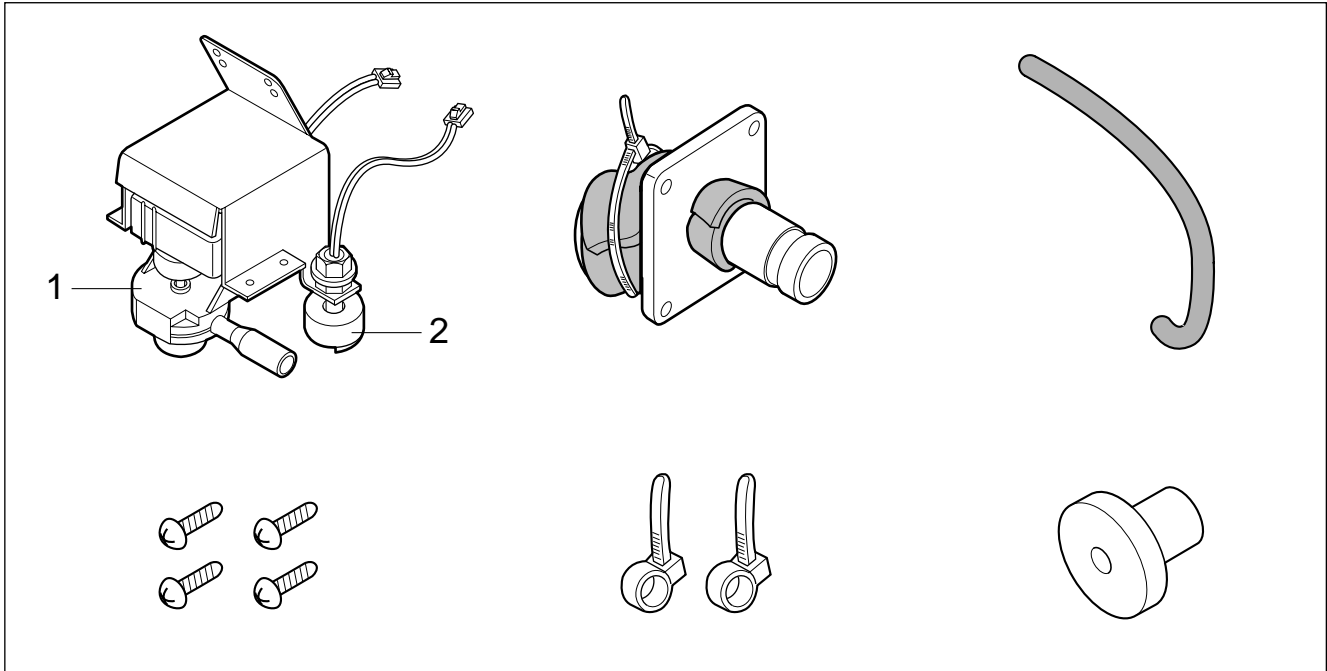

2) Quantity

Quantity	Package contents
1	Drain Pump Assy(AC220~240V, 50/60Hz, 400cm ³ /min)
1	Elbow(ø32mm)
1	Hose
2	Tie Wrap
10	Screw
1	Rubber
1	Installation manual

3) Service Parts List

No.	Location No.	P/No.	Description	Remark
1	158590	5858A10001L	Pump Water	
2	266012	6601A20001E	Switch Assy, Float	

5) Attention

1. Possible drain-head height is up to 700mm. So, it must be installed below 700mm.
2. Keep the drain hose downward up to 1/50~1/100 inclination. Prevent any upward flow or reverse flow in any part.

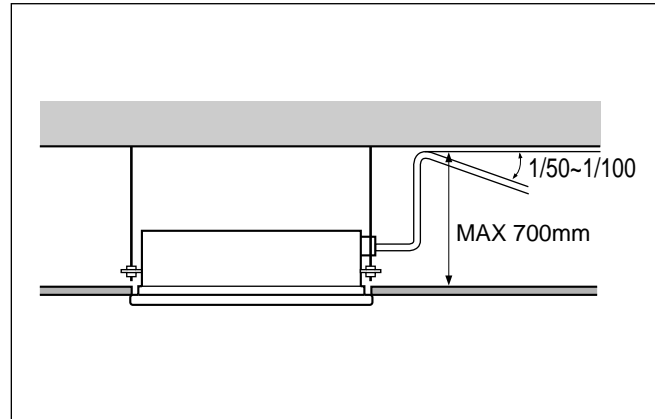

3. 5mm or thicker formed thermal insulator is provided for the drain pipe.

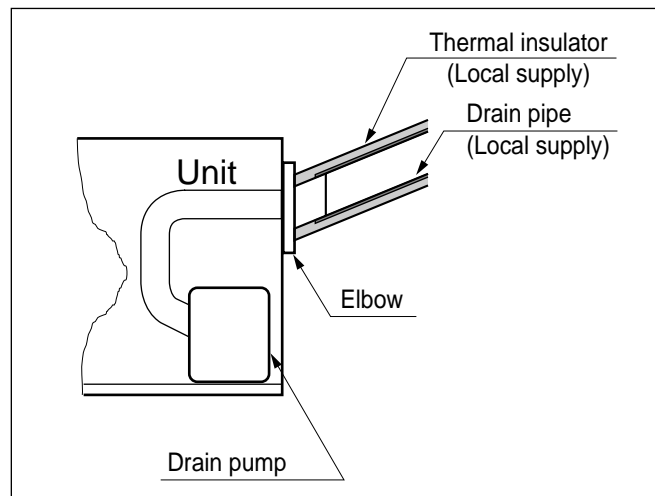

4. Upward routing is not allowed.
5. Be sure to check the drain pump for normal operation and abnormal noise when electrical wiring is complete.

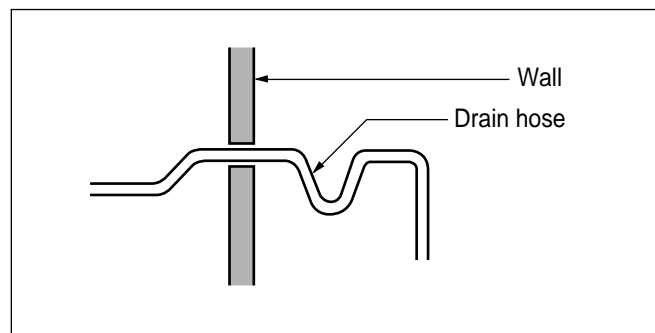

Optional operation

1) Two Thermistor System

- (1) Open the rear cover of the wired remote-control to set the mode.
- (2) Select one of three selectable modes as follows.
 - Position 1:

The room temperature is controlled by the thermistor of the main body.
 - Position 2:

The room temperature is controlled by the thermistor of the wired remote-control, control the temperature according to the position of wired remote-control.
 - Position 3:

The room temperature is controlled by lower temperature between the temperature of main body and of remote-control sensor.
- (3) Move the slide switch to set position.
- (4) Close the rear cover and check if it works normally.

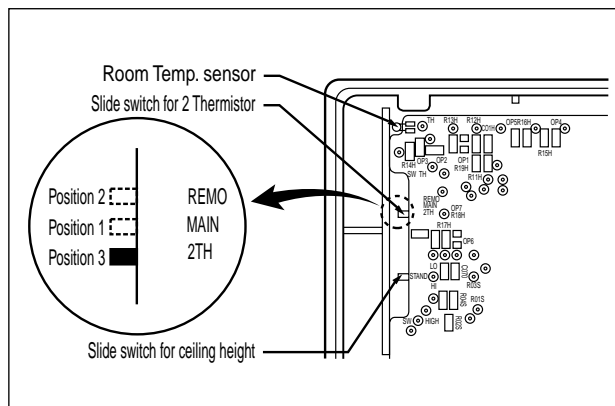

CAUTION :

- **Select the position after counselling with a customer.**
- **In case of cooling mode, room temperature is controlled by the main body sensor.**
- **To control the room temperature by a wired remote control, install the remote control (room temp. sensor) to sense the temperature more accurately.**
- **Manufactured in the position 3.**

2) Adjusting air volume to the height of ceiling

You can choose the RPM(or air volume) of indoor motor according to the height of ceiling to supply the comfortable atmosphere to consumers.

Procedure

1. Choose the selectable position in the table after measuring the height of ceiling.
2. In the case of changing the height as "high" or "low", open the rear cover of the wired remote-control.
3. Move the slide switch to the set position.
4. Close the rear cover and check if it works normally.

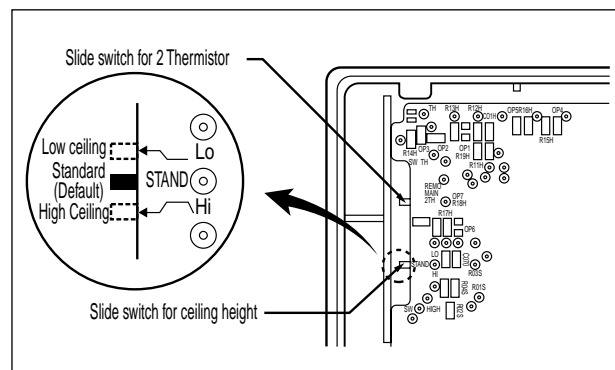

Ceiling height	Mode of slide switch	Change of air volume	Remark
more than 4.0m	High Ceiling	Increasing	Manufactured in standard mode
3.2~4.0m	Standard	-	
less than 3.2m	Low Ceiling	Decreasing	

